

Cylindrical Type Photoelectric Sensor

■ Features

[Common]

- Excellent noise immunity and minimal influence from ambient light
- Power/Output reverse polarity protection circuit, output short over current protection circuit
- Mutual interference prevention function (except through-beam type)
- Sensitivity adjuster
- Light ON, Dark ON switchable by control wire

[BRQT, BRQM, BRQP Series (front sensing type)]

- Various materials: Plastic, Metal (Ni-plated Brass), Stainless steel 316L
- Long sensing distance: 30m (through-beam type)
- Body size - BRQT, BRQM: Standard
BRQP: Standard, Short body
- Protection structure - BRQT: IP67 (IEC standard), IP69K (DIN standard)
BRQM, BRQP: IP67 (IEC standard)

[BRQPS Series (side sensing type)]

- Protection structure: IP67 (IEC standard)

 Please read "Safety Considerations" in the instruction manual before using.



[BRQT, BRQM, BRQP Series (front sensing type)]



BRQT-A
SUS316L Standard



BRQM-A
Ni-plate Brass Standard



BRQP-A
Plastic Standard



BRQP-B
Plastic Short-body

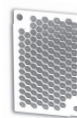

Reflector (MS-2A)



Reflective tape (MST series)

[BRQPS Series (side sensing type)]

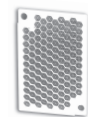

Reflector (MS-2S)



Reflective tape (MST series)

- ※The model name with '-C' is connector type.
- ※Reflective tape (MST series) is sold separately.

■ Ordering Information

BRQ T 5 M - T D T A - C - P

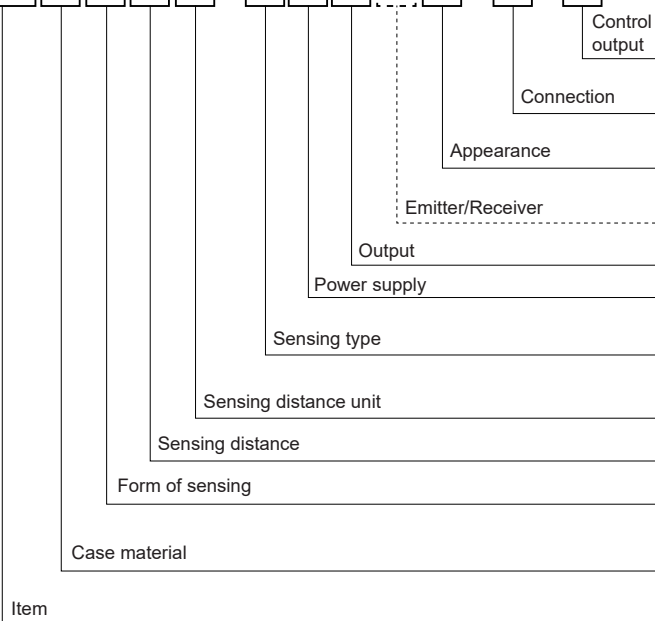

| | Front sensing type | Side sensing type |
|---------|---|-------------------|
| No mark | NPN open collector output | |
| P | PNP open collector output | |
| No mark | Cable type | |
| C | Connector type | |
| A | Standard | Standard |
| B | Short body ^{※1} | — |
| 1 | Emitter | |
| 2 | Receiver | |
| T | Transistor output | |
| D | DC power | |
| T | Through-beam type | |
| P | Retroreflective type (built-in polarizing filter) | |
| D | Diffuse reflective type | |
| No mark | mm | |
| M | m | |
| Number | Sensing distance | |
| No mark | Front sensing type | — |
| S | — | Side sensing type |
| T | Stainless steel 316L | — |
| M | Brass, Ni-plate | — |
| P | Plastic | Plastic |
| BRQ | Cylindrical type photoelectric sensor | |

※1: This is only for BRQP Series.

※: This information is intended for product management of through-beam type. (no need to refer when selecting model)

Cylindrical Type Photoelectric Sensor (Front Sensing Type)

Cylindrical Type Photoelectric Sensor (front sensing type)

■ Specifications

| Model | NPN open collector output | BRQ□5M-TDT□□□ | BRQ□20M-TDT□□□ | BRQ□30M-TDT□□□ | BRQ□3M-PDT□□□ | BRQ□100-DDT□□□ | BRQ□400-DDT□□□ | BRQ□1M-DDT□□□ | |
|------------------------|---|--|---|------------------|---|---|------------------|-----------------|--|
| | PNP open collector output | BRQ□5M-TDT□□□-P | BRQ□20M-TDT□□□-P | BRQ□30M-TDT□□□-P | BRQ□3M-PDT□□□-P | BRQ□100-DDT□□□-P | BRQ□400-DDT□□□-P | BRQ□1M-DDT□□□-P | |
| Sensing type | Through-beam type | | | | Retroreflective type (built-in polarizing filter) | Diffuse reflective type | | | |
| Sensing distance | 5m | 20m | 30m | 3m ^{※1} | 100mm ^{※2} | 400mm ^{※2} | 1m ^{※3} | | |
| Sensing target | Opaque materials of min. Ø7mm | | | | Opaque materials of min. Ø75mm | Opaque, translucent materials | | | |
| Hysteresis | — | | | | | Max. 20% at rated sensing distance | | | |
| Response time | Max. 1ms | | | | | | | | |
| Power supply | 10-30VDC \pm 10% (ripple P-P: max.10%) | | | | | | | | |
| Current consumption | Emitter/Receiver: max. 20mA | | | | Max. 30mA | | | | |
| Light source | Red LED (660nm) | | | | | Infrared LED (850nm) | Red LED (660nm) | | |
| Sensitivity adjustment | Sensitivity adjuster | | | | | | | | |
| Operation mode | Selectable Light ON or Dark ON by control wire (white) | | | | | | | | |
| Control output | NPN or PNP open collector output · Load voltage: max. 30VDC \pm · Load current: max. 100mA · Residual voltage: max. 2VDC \pm | | | | | | | | |
| Protection circuit | Power/Output reverse polarity protection circuit, output short over current protection circuit, interference prevention function (except through-beam type) | | | | | | | | |
| Indicator | Operation indicator: yellow LED, stability indicator: green LED (emitter power indicator of through-beam type: red LED) | | | | | | | | |
| Connection | Cable type, connector type | | | | | | | | |
| Insulation resistance | Over 20MΩ (at 500VDC megger) | | | | | | | | |
| Noise immunity | \pm 240V the square wave noise (pulse width:1μs) by the noise simulator | | | | | | | | |
| Dielectric strength | 1,000VAC 50/60Hz for 1 minute | | | | | | | | |
| Vibration | 1.5mm amplitude at frequency of 10 to 55Hz in each X, Y, Z direction for 2 hours | | | | | | | | |
| Shock | 500m/s ² (approx. 50G) in X, Y, Z direction for 3 times | | | | | | | | |
| Environment | Ambient illu. | Sunlight: max. 11,000lx, Incandescent lamp: max. 3,000lx (receiver illumination) | | | | | | | |
| | Ambient temp. | -25 to 60°C, storage: -30 to 70°C | | | | | | | |
| | Ambient humi. | 35 to 85%RH, storage: 35 to 85%RH | | | | | | | |
| Protection structure | · BRQT Series: IP67 (IEC standard), IP69K (DIN standard) · BRQM, BRQP Series: IP67 (IEC standard) | | | | | | | | |
| Material | · Case: BRQT Series - stainless steel 316L / BRQM Series - brass, Ni-plate / BRQP Series - polycarbonate · Lens, Lens cover: polymethyl methacrylate acrylic | | | | | | | | |
| Cable ^{※4} | Cable type | Ø4mm, 4-wire, 2m (emitter of through-beam type: Ø4mm, 2-wire, 2m) (AWG26, core diameter: 0.52mm, number of cores: 20, insulator out diameter: Ø1mm) | | | | | | — | |
| | Accessory | Individual | — | | | Reflector (MS-2A) | — | | |
| | Common | M18 fixing nut: 4, adjustment screwdriver | | | | M18 fixing nut: 2, adjustment screwdriver | | | |
| Approval | CE  us | | | | | | | | |
| Weight ^{※5} | Cable type | BRQT-A/BRQM-A: approx. 220g (approx. 140g) BRQP-A: approx. 160g (approx. 110g) BRQP-B: approx. 150g (approx. 100g) | | | BRQT-A/BRQM-A: approx. 150g (approx. 70g) BRQP-A: approx. 120g (approx. 60g) BRQP-B: approx. 120g (approx. 50g) | | | | |
| | | Connector type | BRQT-A/BRQM-A: approx. 160g (approx. 50g) BRQP-A: approx. 110g (approx. 25g) BRQP-B: approx. 100g (approx. 20g) | | | BRQT-A/BRQM-A: approx. 140g (approx. 30g) BRQP-A: approx. 110g (approx. 15g) BRQP-B: approx. 100g (approx. 10g) | | | |

※1: The sensing distance is specified with using the MS-2A reflector. The distance between the sensor and the reflector should be set over 0.1m. When using reflective tapes, the reflectivity will vary by the size of the tape. Please refer to the '■ Reflectivity by Reflective Tape Model' table before using the tape.

※2: Non-glossy white paper 100×100mm.

※3: Non-glossy white paper 300×300mm.

※4: M12 connector cable is sold separately.

※5: The weight includes packaging. The weight in parenthesis is for unit only.

※The temperature or humidity mentioned in Environment indicates a non freezing or condensation.

(unit: mm)

■ Dimensions

◎ Through-beam type

- BRQT□-TDTA(-P)
- BRQM□-TDTA(-P)

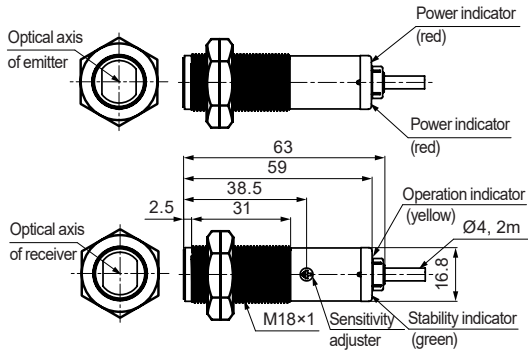

- BRQT□-TDTA-C(-P)
- BRQM□-TDTA-C(-P)

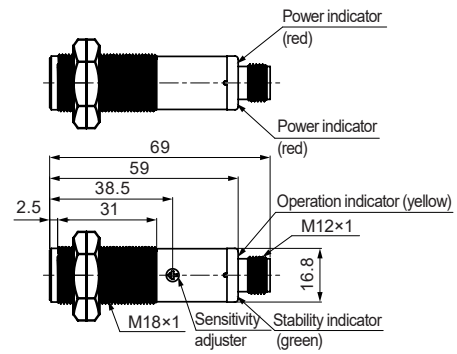

- BRQP□-TDTA(-P)

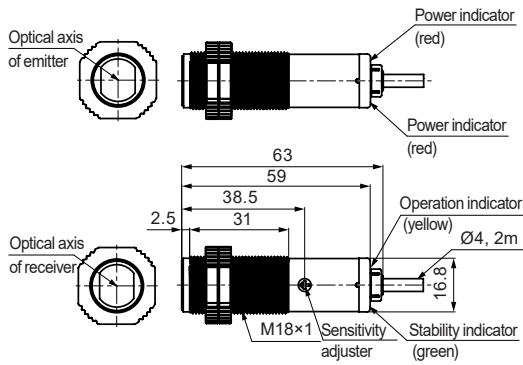

- BRQP□-TDTA-C(-P)

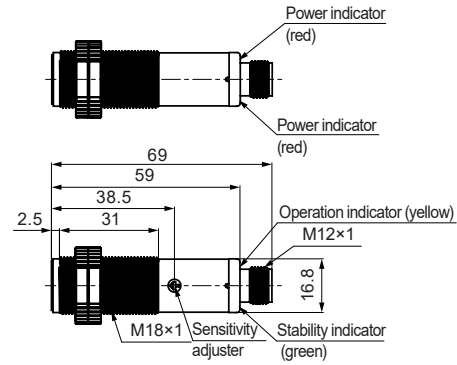

- BRQP□-TDTB(-P)

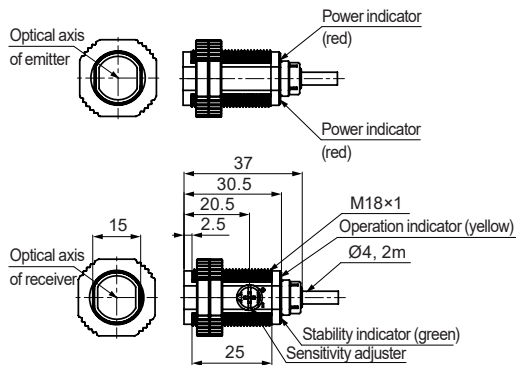

- BRQP□-TDTB-C(-P)

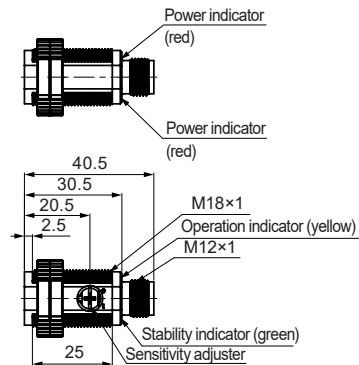

Cylindrical Type Photoelectric Sensor (Front Sensing Type)

◎ Retroreflective/Diffuse reflective type

(unit: mm)

- BRQT3M-PDTA(-P)/BRQM3M-PDTA(-P)
- BRQT□-DDTA(-P)/BRQM□-DDTA(-P)

- BRQT3M-PDTA-C(-P)/BRQM3M-PDTA-C(-P)
- BRQT□-DDTA-C(-P)/BRQM□-DDTA-C(-P)

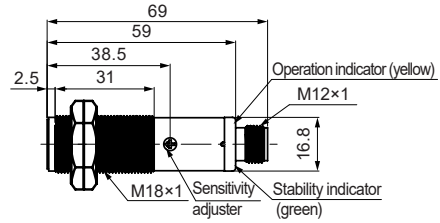
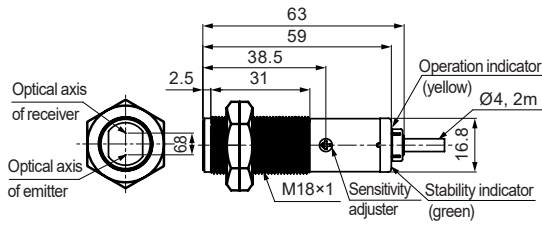

- BRQP3M-PDTA(-P)
- BRQP□-DDTA(-P)

- BRQP3M-PDTA-C(-P)
- BRQP□-DDTA-C(-P)

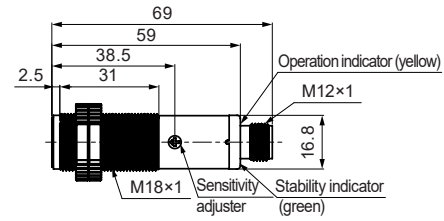
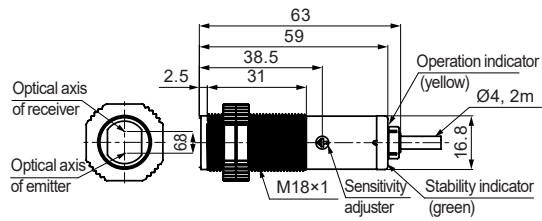

- BRQP3M-PDTB(-P)
- BRQP□-DDTB(-P)

- BRQP3M-PDTB-C(-P)
- BRQP□-DDTB-C(-P)

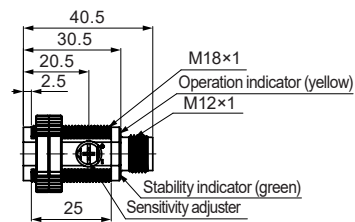
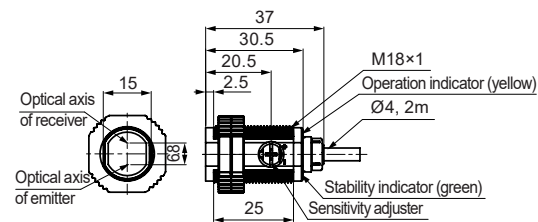

• M18 fixing nut

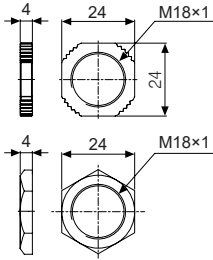

• Reflector

(unit: mm)

• MS-2A

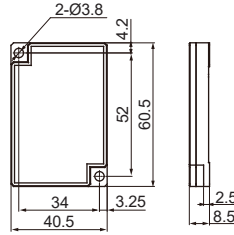

◎ Sold separately

• Bracket(BK-BR-A)

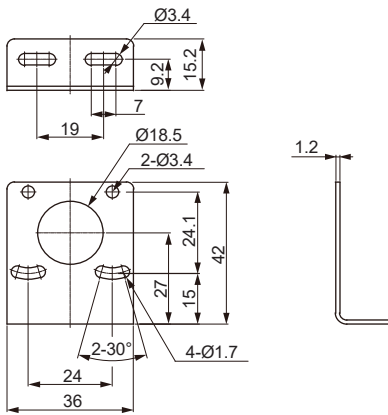

• Fixing cap

(BK-BR-B, only for BRQP□-□□□B-□)

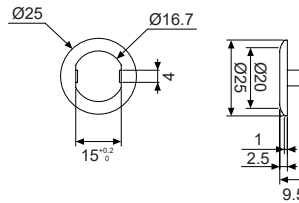

• Connection cable

• CIDH4-□

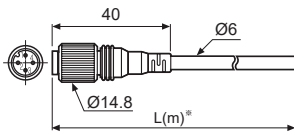

• CLDH4-□

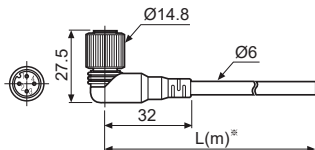

• Reflective tape

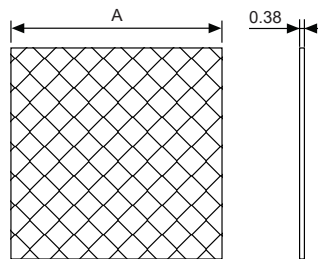

(unit: mm)

| Model | A |
|-----------|------|
| MST-50-10 | □50 |
| MST-100-5 | □100 |
| MST-200-2 | □200 |

※Specification of connector cable: Ø6mm, 4-wire, 2m/3m/5m/7m (AWG22, core diameter: 0.08mm, number of cores: 60, insulator out diameter: Ø1.65mm)

Cylindrical Type Photoelectric Sensor (Front Sensing Type)

■ Feature Data

◎ Through-beam type

● BRQ□5M-TDT□□(-P)

| Parallel shifting characteristic | | Angle characteristic | |
|----------------------------------|------|----------------------|------|
| Measuring method | Data | Measuring method | Data |
| | | | |

● BRQ□20M-TDT□□(-P)

| Parallel shifting characteristic | | Angle characteristic | |
|----------------------------------|------|----------------------|------|
| Measuring method | Data | Measuring method | Data |
| | | | |

● BRQ□30M-TDT□□(-P)

| Parallel shifting characteristic | | Angle characteristic | |
|----------------------------------|------|----------------------|------|
| Measuring method | Data | Measuring method | Data |
| | | | |

◎ Retroreflective type

● BRQ□3M-PDT□□-P

| Parallel shifting characteristic | | Sensor angle characteristic | | Reflector angle characteristic | |
|----------------------------------|------|-----------------------------|------|--------------------------------|------|
| Measuring method | Data | Measuring method | Data | Measuring method | Data |
| | | | | | |

◎ Diffuse reflective type

● BRQ□100-DDT□□(-P)

● BRQ□400-DDT□□(-P)

● BRQ□1M-DDT□□(-P)

| Sensing area characteristic | | Sensing area characteristic | | Sensing area characteristic | |
|-----------------------------|------|-----------------------------|------|-----------------------------|------|
| Measuring method | Data | Measuring method | Data | Measuring method | Data |
| | | | | | |

■ Control Output Circuit Diagram

● Through-beam/Retroreflective/Diffuse reflective type

| NPN open collector output | | PNP open collector output | |
|------------------------------|--|------------------------------|--|
| Photoelectric sensor circuit | Connection | Photoelectric sensor circuit | Connection |
| | <p>(brown) +V</p> <p>(black) Output Load</p> <p>Max. 100mA</p> <p>10-30VDC</p> <p>(blue) 0V</p> <p>(white) Control</p> | | <p>(brown) +V</p> <p>(black) Output Load</p> <p>Max. 100mA</p> <p>10-30VDC</p> <p>(blue) 0V</p> <p>(white) Control</p> |

※ Before using this unit, select Light ON/Dark ON with control cable.

(Light ON: connect control cable with 0V/Dark ON: connect control cable with +V)

※ If short-circuit the control output terminal or supply current over the rated specification, normal control signal is not output due to the output short over current protection circuit.

■ Connections for Connector Part

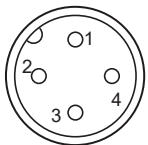

M12 Connector pin

| Pin No. | Cable color | Application | Through-beam type | |
|---------|-------------|-------------|-------------------|----------|
| | | | Emitter | Receiver |
| 1 | Brown | 30VDC | 30VDC | 30VDC |
| 2 | White | CONTROL | N.C | CONTROL |
| 3 | Blue | GND | GND | GND |
| 4 | Black | OUTPUT | N.C | OUTPUT |

● Connector cable (sold separately)

※ Please refer to the connector cable part.

Cylindrical Type Photoelectric Sensor (Front Sensing Type)

■ Operation Timing Diagram

◎ Through-beam type

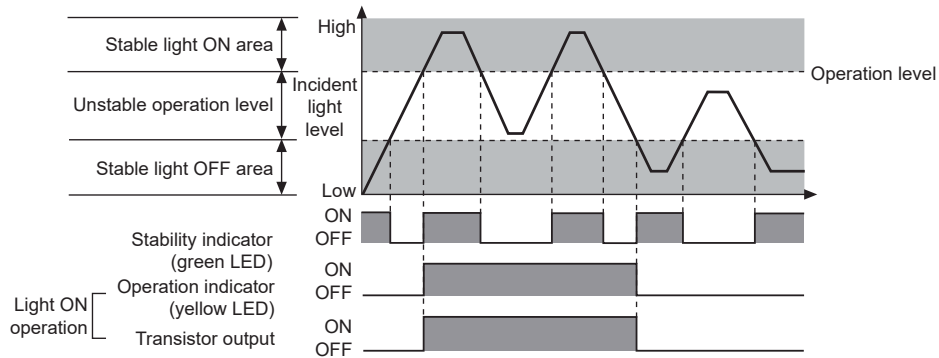

◎ Retroreflective/Diffuse reflective type

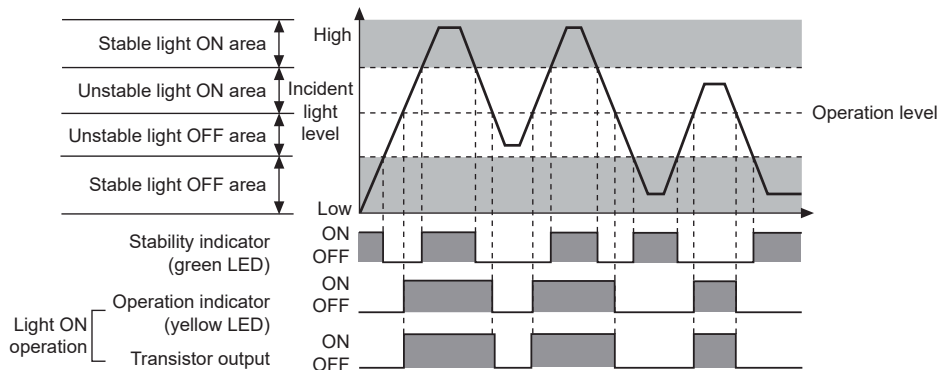

※The waveforms of 'Operation indicator' and 'Transistor output' are for Light ON operation.
They are opposite operation for Dark ON operation.

■ Connections

• Through-beam type

<Cable type>

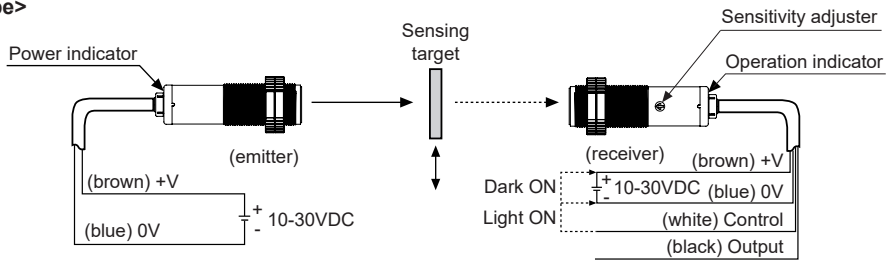

<Connector type>

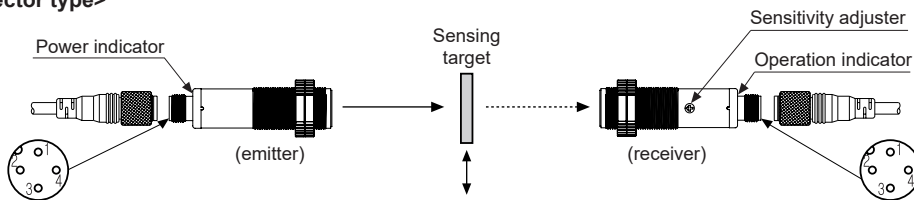

• Retroreflective type

<Cable type>

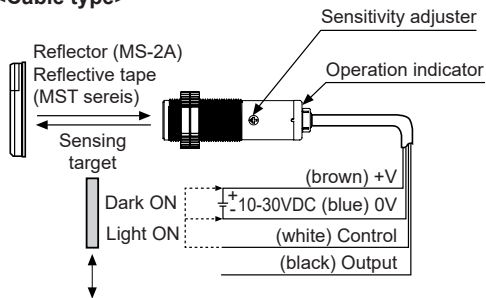

<Connector type>

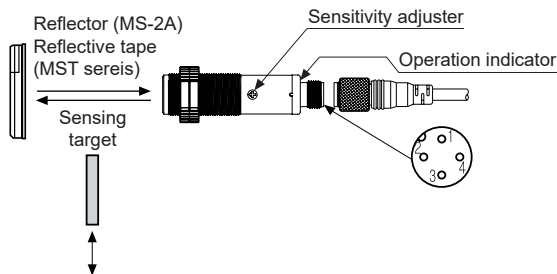

• Diffuse reflective type

<Cable type>

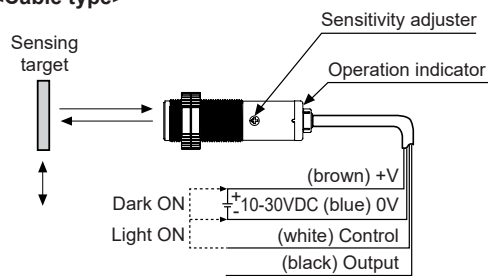

<Connector type>

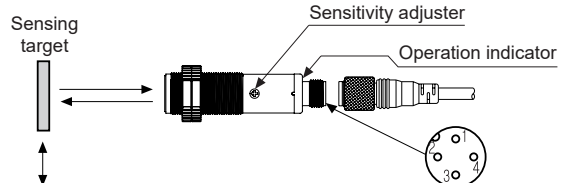

Cylindrical Type Photoelectric Sensor (Front Sensing Type)

■ Installation and Adjustment

Install the sensor to the desired place and check the connections. Supply the power to the sensor and adjust the optical axis and the sensitivity as following.

When using the reflective type photoelectric sensors closely over three units, it may result in malfunction due to mutual interference.

When using the through-beam type photoelectric sensors closely over two units, it may result in malfunction due to mutual interference.

When installing the product, tighten the screw with a tightening torque of 14.7N·m for BRQT/BRQM and 0.39N·m for BRQP.

◎ Through-beam type

1. Supply the power to the photoelectric sensor, after setting the emitter and the receiver facing each other.
2. Set the receiver in center of position in the middle of the operation range of indicator adjusting the receiver or the emitter right and left, up and down.
3. After adjustment, check the stability of operation putting the object at the optical axis.

※If the sensing target is translucent body or smaller than $\varnothing 7\text{mm}$, it can be missed by sensor cause light penetrate it.

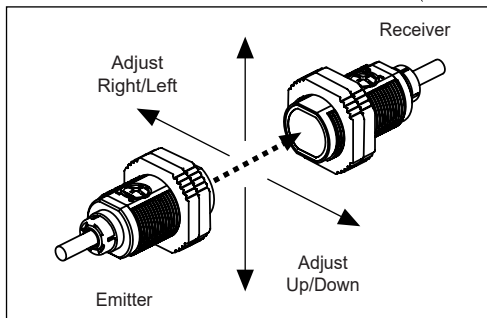

◎ Retroreflective type

1. Supply the power to the photoelectric sensor, after setting the photoelectric sensor and the reflector (MS-2A) or reflective tape in face to face.
2. Set the photoelectric sensor in the position which indicator turns on, as adjusting the reflector or the sensor right and left, up and down.
3. Fix both units tightly after checking that the unit detects the target.

※Sensitivity adjustment

: Refer to the diffuse reflective type's.

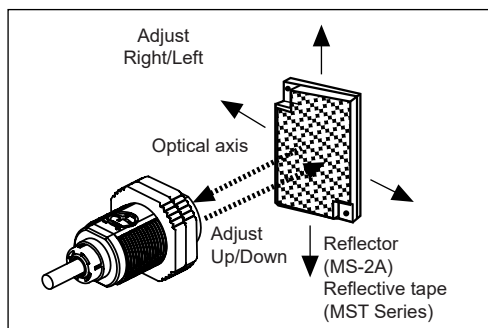

◎ Diffuse reflective type

1. The sensitivity should be adjusted depending on a sensing target or mounting place.

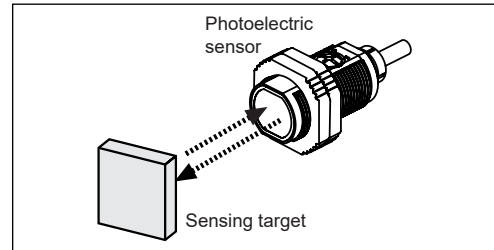

2. Set the target at a position to be detected by the beam, then turn the sensitivity adjuster until position ㊦ where the operation indicator turns ON from min. position of the Sensitivity adjuster.
3. Take the target out of the sensing area, then turn the Sensitivity adjuster until position ㊧ where the operation indicator turns ON. If the indicator dose not turn ON, max. position is ㊨.
4. Set the sensitivity adjuster at the center of two switching position ㊦, ㊧.

※Be aware of the fact that sensing distance can be different by size, surface and gloss of the target.

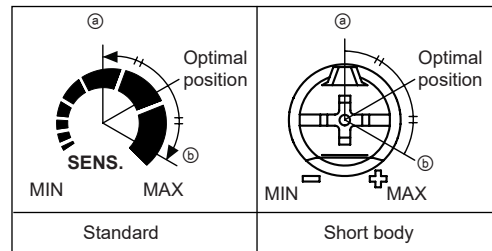

■ Reflectivity by Reflective Tape Model

| Model | Standard | Short body |
|--------------------------|----------|------------|
| MST-50-10 (50×50mm) | 40% | 40% |
| MST-100-5 (100×100mm) | 50% | 80% |
| MST-200-2 (200×200mm) | 80% | 85% |

※This reflectivity is based on the reflector (MS-2A).

※Reflectivity may vary depending on usage environment and installation conditions.

The sensing distance and minimum sensing target size increase as the size of the tape increases.

Please check the reflectivity before using reflective tapes.

※For using reflective tape, installation distance should be min. 20mm.

Cylindrical Type Photoelectric Sensor (side sensing type)

■ Specifications

| Model | BRQPS10M-TDTA(-C) | | BRQPS20M-TDTA(-C) | | BRQPS3M-PDTA(-C) | | BRQPS100-DDTA(-C) | | BRQPS400-DDTA(-C) | | BRQPS700-DDTA(-C) | | |
|------------------------|-------------------|---|-------------------|---------------------|------------------|---|-------------------|-------------------------------|-------------------|---------------------|-------------------|--------------------------------------|--|
| | collector output | | collector output | | collector output | | collector output | | collector output | | collector output | | |
| Model | | BRQPS10M-TDTA(-C)-P | | BRQPS20M-TDTA(-C)-P | | BRQPS3M-PDTA(-C)-P | | BRQPS100-DDTA(-C)-P | | BRQPS400-DDTA(-C)-P | | BRQPS700-DDTA(-C)-P | |
| Sensing type | | Through-beam type | | | | Retroreflective type (built-in polarizing filter) | | Diffuse reflective type | | | | | |
| Sensing distance | | 10m | | 20m | | 3m ^{※1} | | 100mm ^{※2} | | 400mm ^{※2} | | 700mm ^{※3} | |
| Sensing target | | Opaque materials of min. Ø7mm | | | | Opaque materials of min. Ø75mm | | Opaque, translucent materials | | | | | |
| Hysteresis | | — | | | | | | | | | | Max. 20% of maximum sensing distance | |
| Response time | | Max. 1ms | | | | | | | | | | | |
| Power supply | | 10-30VDC \pm 10% (ripple P-P: max. 10%) | | | | | | | | | | | |
| Current consumption | | Emitter/Receiver: max. 20mA | | | | Max. 30mA | | | | | | | |
| Light source | | Red LED (660nm) | | | | | | | | | | | |
| Sensitivity adjustment | | Sensitivity adjuster | | | | | | | | | | | |
| Operation mode | | Selectable Light ON or Dark ON by control wire (white) | | | | | | | | | | | |
| Control output | | NPN or PNP open collector output • Load voltage: max. 30VDC \pm • Load current: max. 100mA • Residual voltage: max. 2VDC \pm | | | | | | | | | | | |
| Protection circuit | | Power/Output reverse polarity protection circuit, output short over current protection circuit, interference prevention function (except through-beam type) | | | | | | | | | | | |
| Indicator | | Operation indicator: yellow LED, stability indicator: green LED (emitter power indicator of through-beam type: red LED) | | | | | | | | | | | |
| Connection | | Cable type, connector type | | | | | | | | | | | |
| Insulation resistance | | Over 20MΩ (at 500VDC megger) | | | | | | | | | | | |
| Noise immunity | | \pm 240V the square wave noise (pulse width: 1μs) by the noise simulator | | | | | | | | | | | |
| Dielectric strength | | 1,000VAC 50/60Hz for 1 minute | | | | | | | | | | | |
| Vibration | | 1.5mm amplitude at frequency of 10 to 55Hz in each X, Y, Z direction for 2 hours | | | | | | | | | | | |
| Shock | | 500m/s ² (approx. 50G) in X, Y, Z directions for 3 times | | | | | | | | | | | |
| Environment | Ambient illu. | Sunlight: max.11,000lx, incandescent lamp: 3,000lx (receiver illumination) | | | | | | | | | | | |
| | Ambient temp. | -25 to 60°C, storage: -30 to 70°C | | | | | | | | | | | |
| | Ambient humi. | 35 to 85%RH, storage: 35 to 85%RH | | | | | | | | | | | |
| Protection structure | | IP67 (IEC standard) | | | | | | | | | | | |
| Material | | Case: polycarbonate, lens, lens cover: polymethyl methacrylate acrylic | | | | | | | | | | | |
| Cable ^{※4} | | Ø4mm, 4-wire, 2m (emitter of through-beam type: Ø4mm, 2-wire, 2m) (AWG26, core diameter: 0.52mm, number of cores: 20, insulator out diameter: Ø1mm) | | | | | | | | | | | |
| Accessory | Individual | — | | | | Reflector (MS-2S) | | | | — | | | |
| | Common | M18 fixing nut: 4, adjustment screwdriver | | | | M18 fixing nut: 2, adjustment screwdriver | | | | | | | |
| Approval | |  | | | | | | | | | | | |
| Weight ^{※5} | Cable type | Approx. 170g (approx. 120g) | | | | Approx. 130g (approx. 70g) | | | | | | | |
| | Connector type | Approx. 120g (approx. 35g) | | | | Approx. 120g (approx. 25g) | | | | | | | |

※1: The sensing distance is specified with the MS-2S reflector. The distance between the sensor and the reflector should be set over 0.1m. When using reflective tapes, the reflectivity will vary by the size of the tape. Please refer to the '■ Reflectivity by Reflective Tape Model' table before using the tape.

※2: Non-glossy white paper 100×100mm.

※3: Non-glossy white paper 200×200mm.

※4: M12 connector cable is sold separately.

※5: The weight includes packaging. The weight in parenthesis is for unit only.

※ The temperature and humidity mentioned in Environment indicates a non freezing or condensation.

Cylindrical Type Photoelectric Sensor (Side Sensing Type)

■ Dimensions

(unit: mm)

◎ Through-beam type

● BRQPS□-TDTA(-P)

• Emitter

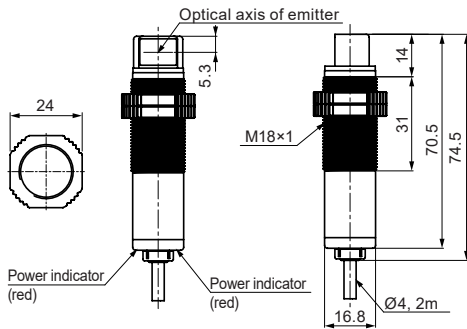

● BRQPS□-TDTA-C(-P)

• Emitter

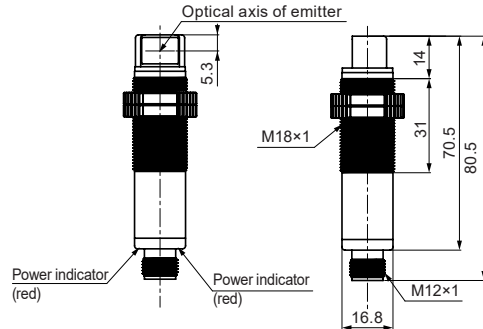

• Receiver

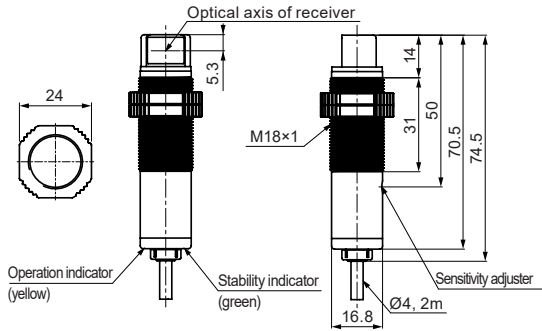

• Receiver

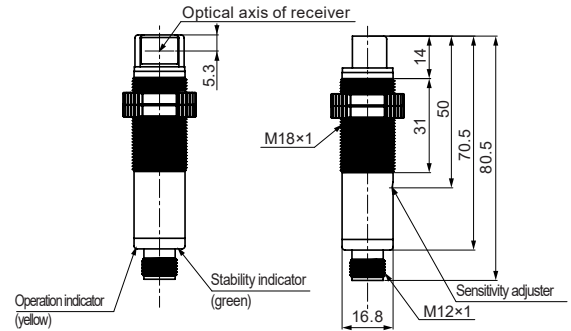

◎ Retroreflective/Diffuse reflective type

● BRQPS□-DDTA(-P)

● BRQPS3M-PDTA(-P)

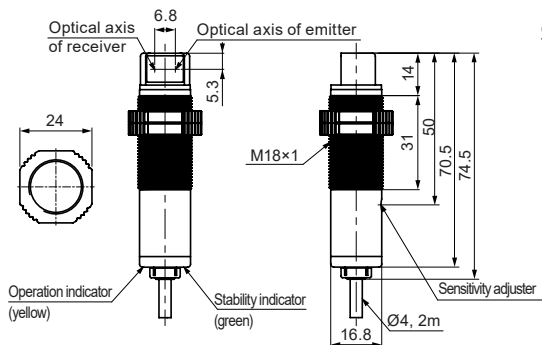

● BRQPS□-DDTA-C(-P)

● BRQPS3M-PDTA-C(-P)

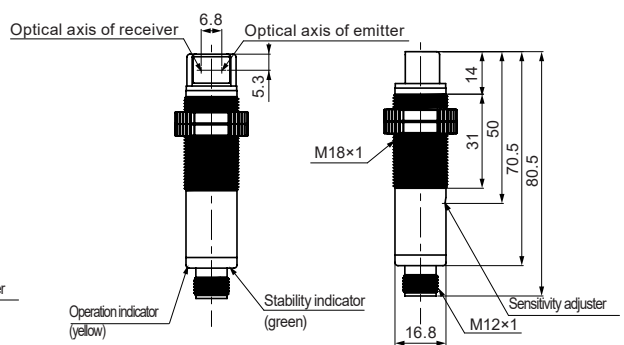

• M18 fixing nut

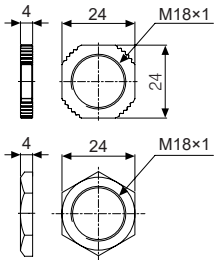

• Reflector

(unit: mm)

• MS-2S

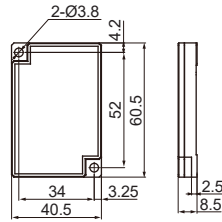

◎ Sold separately

• Bracket(BK-BR-A)

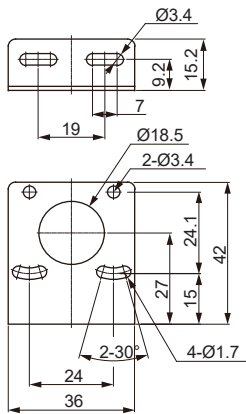

• Reflective tape

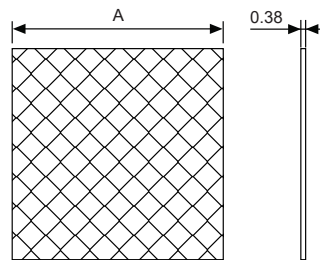

(unit: mm)

| Model | A |
|-----------|------|
| MST-50-10 | □50 |
| MST-100-5 | □100 |
| MST-200-2 | □200 |

• Connection cable

• CIDH4-□

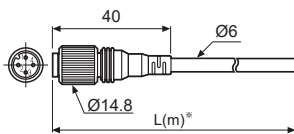

• CLDH4-□

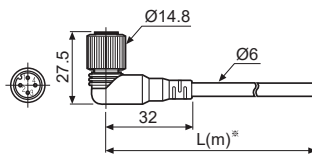

※Specification of connector cable: Ø6mm, 4-wire, 2m/3m/5m/7m
(AWG22, core diameter: 0.08mm, number of cores: 60, insulator out diameter: Ø1.65mm)

Cylindrical Type Photoelectric Sensor (Side Sensing Type)

■ Feature Data

◎ Diffuse reflective type

● BRQPS100-DDTA-□(-P)

● BRQPS400-DDTA-□(-P)

● BRQPS700-DDTA-□(-P)

| Sensing area characteristic | | Sensing area characteristic | | Sensing area characteristic | |
|-----------------------------|------|-----------------------------|------|-----------------------------|------|
| Measuring method | Data | Measuring method | Data | Measuring method | Data |
| | | | | | |

◎ Retroreflective type

● BRQPS3M-PDTA-□(-P)

| Parallel shifting characteristic | | Sensor angle characteristic | | Reflector angle characteristic | |
|----------------------------------|------|-----------------------------|------|--------------------------------|------|
| Measuring method | Data | Measuring method | Data | Measuring method | Data |
| | | | | | |

◎ Through-beam type

● BRQPS10M-TDTA-□(-P)

| Parallel shifting characteristic | | Angle characteristic | |
|----------------------------------|------|----------------------|------|
| Measuring method | Data | Measuring method | Data |
| | | | |

● BRQPS20M-TDTA-□(-P)

| Parallel shifting characteristic | | Angle characteristic | |
|----------------------------------|------|----------------------|------|
| Measuring method | Data | Measuring method | Data |
| | | | |

Control Output Circuit Diagram

Through-beam/Retroreflective/Diffuse reflective type

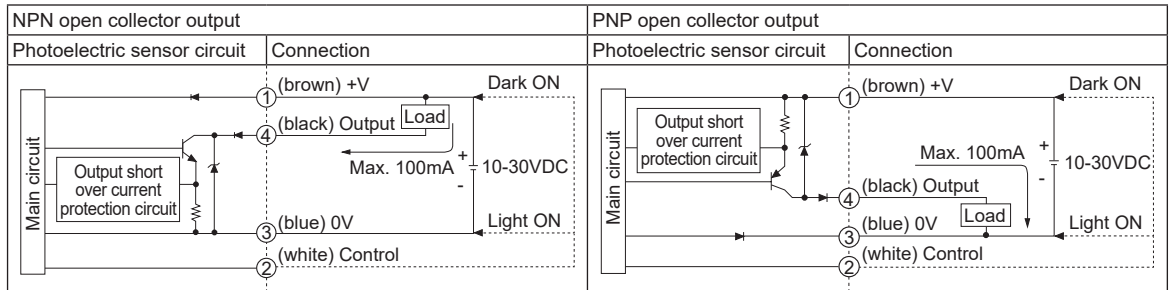

※Before using this unit, select Light ON/Dark ON with control wire. (Light ON: connect control wire to 0V/Dark ON: connect control wire to +V)
 ※If short-circuit the control output terminal or supply current over the rated specification, normal control signal is not output due to the output short over current protection circuit

Connections for Connector Part

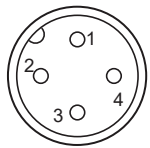

M12 Connector pin

| Pin No. | Cable color | Application Diffuse/ Retroreflective type | Through-beam type | |
|---------|-------------|---|-------------------|----------|
| | | | Emitter | Receiver |
| 1 | Brown | 30VDC | 30VDC | 30VDC |
| 2 | White | CONTROL | N.C | CONTROL |
| 3 | Blue | GND | GND | GND |
| 4 | Black | OUTPUT | N.C | OUTPUT |

● Connector cable (sold separately)
 ※Please refer to the connector cable part.

Operation Timing Diagram

Through-beam type

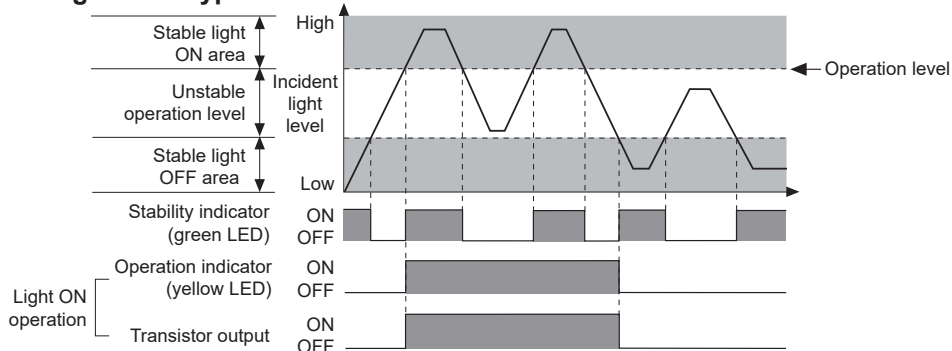

Retroreflective/Diffuse reflective type

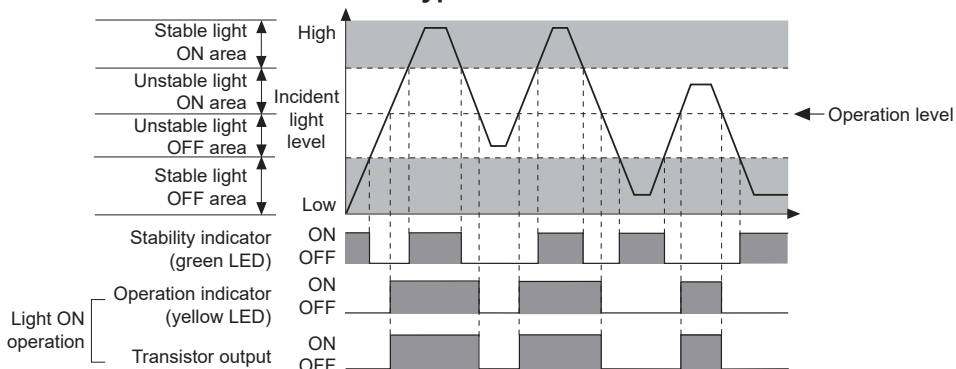

※The waveforms of 'Operation indicator' and 'Transistor output' are for Light ON operation. The waveforms are reversed in Dark On operation.

Cylindrical Type Photoelectric Sensor (Side Sensing Type)

■ Connections

• Through-beam type

<Cable type>

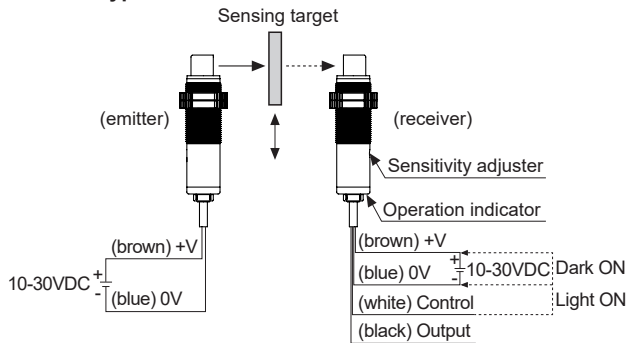

<Connector type>

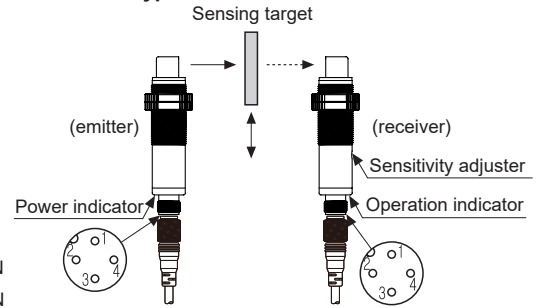

• Retroreflective type

<Cable type>

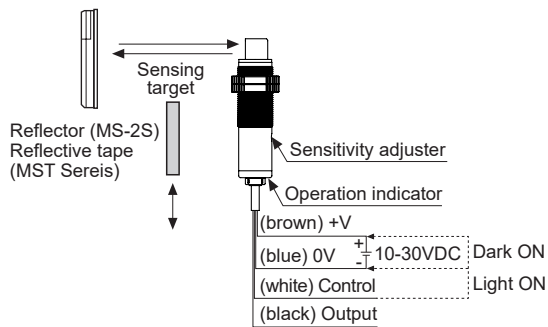

<Connector type>

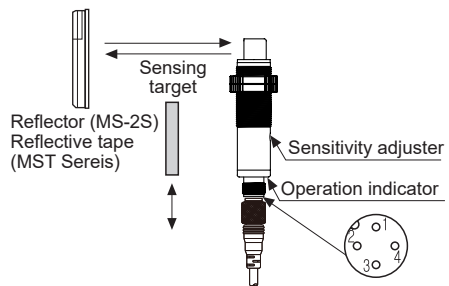

• Diffuse reflective type

<Cable type>

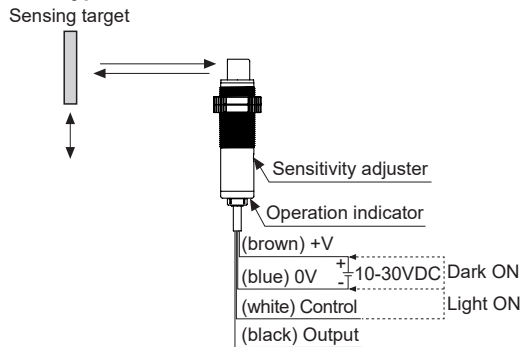

<Connector type>

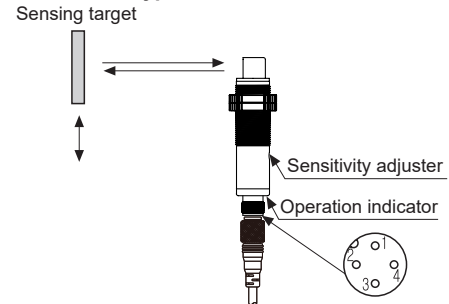

■ Installation and Adjustment

Install the sensor to the desired place and check the connections.

Supply the power to the sensor and adjust the optical axis and the sensitivity as following.

When using the reflective type photoelectric sensors closely over three units, it may result in malfunction due to mutual interference.

When using the through-beam type photoelectric sensors closely over two units, it may result in malfunction due to mutual interference.

When installing the product, tighten the fixing nuts with a tightening torque of 0.39N·m.

◎ Through-beam type

1. Supply the power to the photoelectric sensor, after setting the emitter and the receiver facing each other.
 2. Set the receiver in center of position in the middle of the operation range of indicator adjusting the receiver or the emitter right and left, up and down.
 3. After adjustment, check the stability of operation putting the object at the optical axis.
- ※If the sensing target is translucent body or smaller than $\varnothing 7\text{mm}$, it can be missed by sensor cause light penetrate it.

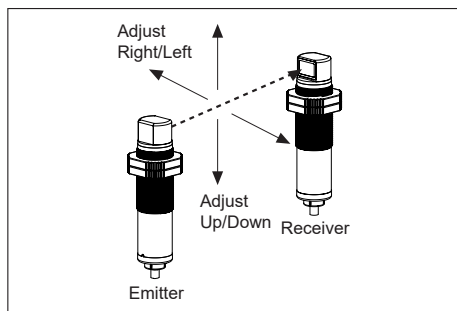

◎ Diffuse reflective type

1. The sensitivity should be adjusted depending on a sensing target or mounting place.
 2. Set the target at a position to be detected by the beam, then turn the sensitivity adjuster until position ㊸ where the operation indicator turns ON from min. position of the sensitivity adjuster.
 3. Take the target out of the sensing area, then turn the sensitivity adjuster until position ㊹ where the the operation indicator turns ON.
- If the indicator dose not turn ON, max. position is ㊺.
4. Set the sensitivity adjuster at the center of two switching position ㊸, ㊹.
- ※Be aware of the fact that sensing distance can be different by size, surface and gloss of the target.

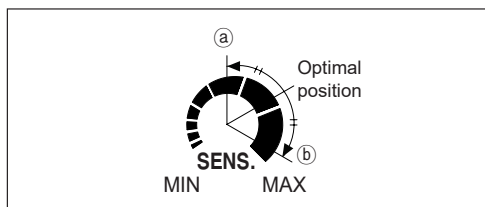
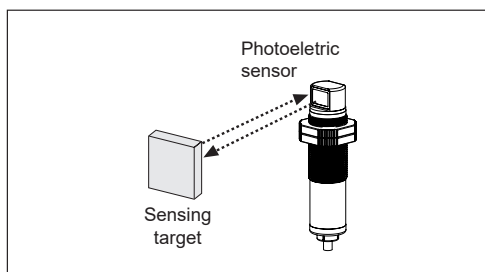

◎ Retroreflective type

1. Supply the power to the photoelectric sensor, after setting the photoelectric sensor and the reflector (MS-2S) or reflective tape in face to face.
2. Set the photoelectric sensor in the position which indicator turns on, as adjusting the reflector or the sensor right and left, up and down.
3. Fix both units tightly after checking that the unit detects the target.

※Sensitivity adjustment
: Refer to the diffuse reflective type's.

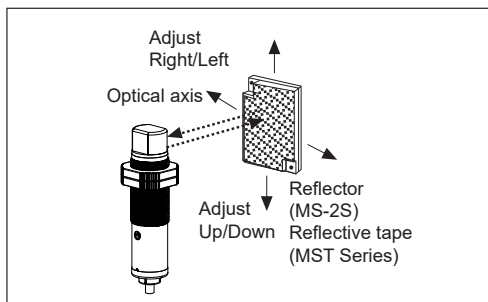

■ Reflectivity by Reflective Tape Model

| | |
|-----------------------|-----|
| MST-50-10 (50×50mm) | 25% |
| MST-100-5 (100×100mm) | 30% |
| MST-200-2 (200×200mm) | 35% |

※This reflectivity is based on the reflector (MS-2S).

※Reflectivity may vary depending on usage environment and installation conditions.

The sensing distance and minimum sensing target size increase as the size of the tape increases. Please check the reflectivity before using reflective tapes.

※For using reflective tape, installation distance should be min. 20mm.