

Turbine Flow Meter
B16D Series FloClean Sanitary



TRB-UM-02184-EN-02 (December 2016)

User Manual

CONTENTS

Scope of This Manual	3
Unpacking and Inspection	3
Safety	3
Terminology and Symbols	3
Considerations	3
Introduction.	4
Operating Principle	4
Installation.	5
Plumbing.	5
Wiring.	7
Operational Startup.	9
Meter Repair And Cleaning	9
Repair Kits	9
Turbine Repair Kits Part Numbers	9
Service Procedures.	10
B16D Series (Cop/Sop) 3-A Turbine Installation	11
Troubleshooting Guide.	12
3-A Certificate	13
Specifications.	14
FloClean Flow Rate Chart.	14
Dimensions and Drawing	15
Model Numbers	16

SCOPE OF THIS MANUAL

This manual is intended to help you get the FloClean Sanitary Meter up and running quickly.

IMPORTANT

Read this manual carefully before attempting any installation or operation. Keep the manual accessible for future reference.

UNPACKING AND INSPECTION

Upon opening the shipping container, visually inspect the product and applicable accessories for any physical damage such as scratches, loose or broken parts, or any other sign of damage that may have occurred during shipment.

NOTE: If damage is found, request an inspection by the carrier's agent within 48 hours of delivery and file a claim with the carrier. A claim for equipment damage in transit is the sole responsibility of the purchaser.

SAFETY

Terminology and Symbols



Indicates a hazardous situation, which, if not avoided, is estimated to be capable of causing death or serious personal injury.



Indicates a hazardous situation, which, if not avoided, could result in severe personal injury or death.



Indicates a hazardous situation, which, if not avoided, is estimated to be capable of causing minor or moderate personal injury or damage to property.

Considerations

The installation of the FloClean Sanitary Meter must comply with all applicable federal, state, and local rules, regulations, and codes.



EXPLOSION HAZARD - SUBSTITUTION OF COMPONENTS MAY IMPAIR SUITABILITY FOR CLASS I, DIVISION 2.



RISQUE D'EXPLOSION - LA SUBSTITUTION DE COMPOSANTS PEUT RENDRE CEMATÉRIEL INACCEPTABLE POUR LES EMPLACEMENTS DE CLASSE I, DIVISION 2.



DO NOT CONNECT OR DISCONNECT EITHER POWER OR OUTPUTS UNLESS THE AREA IS KNOWN TO BE NON-HAZARDOUS.



RISQUE D'EXPLOSION. NE PAS DÉBRANCHER TANT QUE LE CIRCUIT EST SOUSTENSION, À MOINS QU'LL NE S'AGISSE D'UN EMPLACEMENT NON DANGEREUX.

IMPORTANT

Not following instructions properly may impair safety of equipment and/or personnel.

INTRODUCTION

The Blancett FloClean turbine flow meter is designed with wear-resistant moving parts for trouble-free operation and long service life. The durable 316L stainless steel construction is a cost efficient flow measurement system that offers excellent accuracy and repeatability. The FloClean turbine meter repair kit is designed for easy field service of a damaged flow meter, rather than replacing the entire flow meter. See “Repair Kits” on page 9 for information.

OPERATING PRINCIPLE

Fluid entering the meter passes through the inlet flow straightener, which reduces its turbulent flow pattern and improves the fluid’s velocity profile. Fluid then passes through the turbine, causing it to rotate at a speed proportional to the fluid velocity. As each turbine blade passes through the magnetic field, the blade generates an AC voltage pulse in the pickup coil at the base of the magnetic pickup. These pulses produce an output frequency proportional to the volumetric flow through the meter. The output frequency represents flow rate and/or totalization of fluid passing through the turbine flow meter.

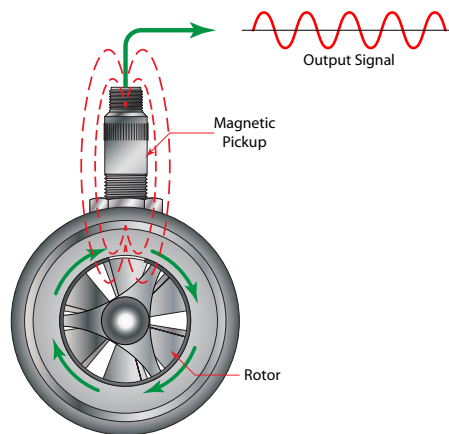

INSTALLATION

CAUTION

THE METER SHOULD NOT BE SUBJECTED TO TEMPERATURES ABOVE 300° F (149° C), BELOW -150° F (-101° C) OR THE FREEZING POINT OF THE METERED LIQUID. HIGH TEMPERATURES WILL DAMAGE THE MAGNETIC PICKUP, WHILE LOWER TEMPERATURES WILL LIMIT THE ROTATION OF THE ROTOR.

CAUTION

INCOMPATIBLE FLUIDS COULD DETERIORATE INTERNAL PARTS AND CAUSE THE METER TO READ INACCURATELY.

Plumbing

Install the flow meter with the flow arrow, which is etched on the exterior of the meter body, pointing in the direction of fluid flow. Install the meter horizontally with the magnetic pickup facing upward.

The liquid being measured must be free of any large particles that may obstruct spinning of the rotor. If particles are present, install a mesh strainer.

If small particles are present in the fluid, install a strainer upstream of the meter. See *Table 1* for filtration recommendations.

Bore Size	Ferrule Size	Strainer Size	Clearance
3/8 in. (9.53 mm)	0.984 in. (24.99 mm)	60 × 60	0.0092 in. (0.23 mm)
1/2 in. (12.7 mm)	0.984 in. (24.99 mm)	60 × 60	0.0092 in. (0.23 mm)
3/4 in. (19.05 mm)	0.984 in. (24.99 mm)	60 × 60	0.0092 in. (0.23 mm)
1/2 in. (12.7 mm)	1.984 in. (50.39 mm)	60 × 60	0.0092 in. (0.23 mm)
3/4 in. (19.05 mm)	1.984 in. (50.39 mm)	60 × 60	0.0092 in. (0.23 mm)
7/8 in. (22.23 mm)	1.984 in. (50.39 mm)	60 × 60	0.0092 in. (0.23 mm)
1 in. (25.4 mm)	1.984 in. (50.39 mm)	60 × 60	0.0092 in. (0.23 mm)
1-1/2 in. (38.1 mm)	1.984 in. (50.39 mm)	20 × 20	0.034 in. (0.86 mm)
2 in. (50.8 mm)	3.047 in. (77.39 mm)	10 × 10	0.065 in. (16.51 mm)

Table 1: Straighter size recommendations

Severe pulsation and mechanical vibration affects accuracy and shortens the life of the meter.

Install a bypass line to accommodate inspection and repair without interrupting flow. See *Figure 1*. If a bypass line cannot be used, install all control valves or restrictions that may cause the liquid to flash downstream of the flow meter. Install air eliminators to make sure that the meter is not incorrectly measuring entrained air or gas. See *Figure 2 on page 6*.

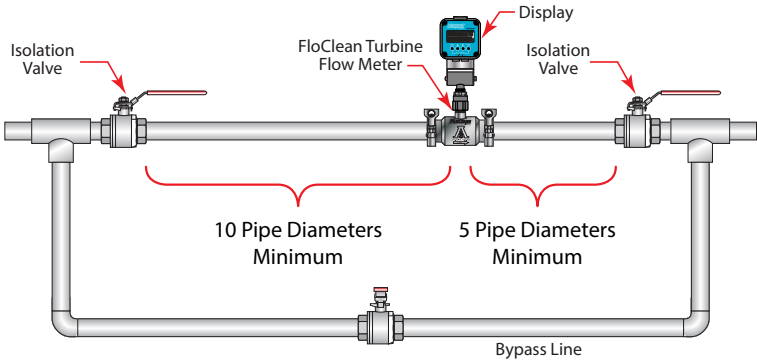

Figure 1: Installation with bypass line

Install a minimum length of 10 pipe diameters of straight pipe on the upstream side, and 5 diameters on the downstream side of the flow meter. The piping should be the same size as the meter bore or threaded port size.

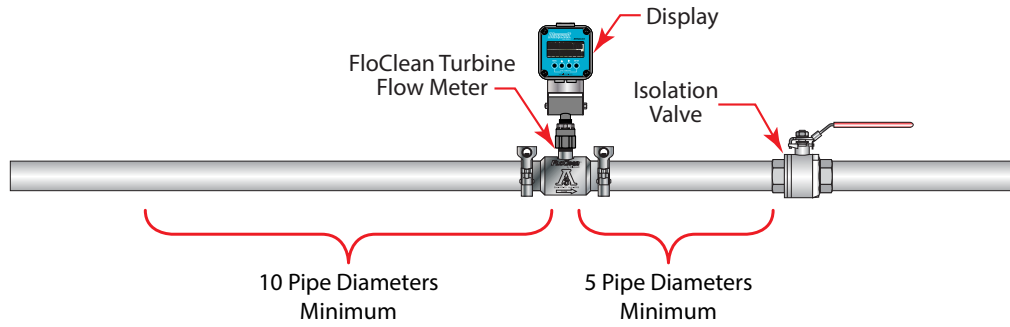

Figure 2: Installation without a bypass line

Do not install the flow meter or connection cable close to electric motors, transformers, sparking devices or high voltage lines. Do not place connecting cable in the same conduit with wires that furnish power for such devices. These devices can induce false signals in the flow meter coil or cable causing the meter to read inaccurately.

CAUTION

DAMAGE CAN BE CAUSED BY STRIKING AN EMPTY METER WITH A HIGH VELOCITY FLOW STREAM.

If problems arise with the flow meter and monitor, consult the *“Troubleshooting Guide”* on page 12. If further problems arise, consult the factory.

If the internal components of the turbine flow meter are damaged, order a turbine meter repair kit. See *“Repair Kits”* on page 9.

Wiring

Typical wiring configurations for the pickup options are shown in *Figure 3, Figure 4 on page 8, and Figure 5 on page 8.*

Option Number	Description	Number of Pins
0	NEMA 6 – Magnetic	3
1	NEMA 6 – Magnetic (Amplified)	3
2	Non-NEMA 6 – Magnetic	2
3	Non-NEMA 6 – Magnetic (Amplified)	3
4	Non-NEMA 6 – Active (4...20 mA)	5
6	Non-NEMA 6 – Magnetic (High Temperature)	2
8	Non-NEMA 6 – Active (0...5V DC)	5
9	No Pickup	N/A

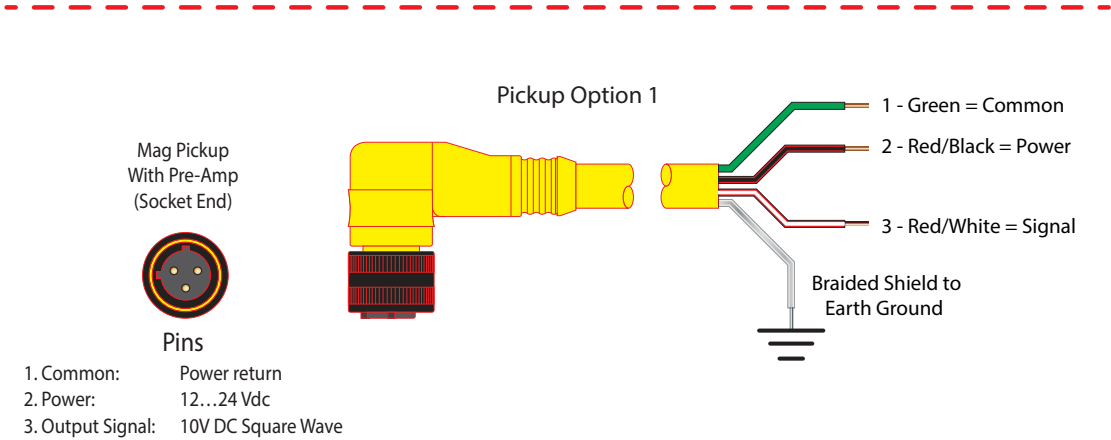
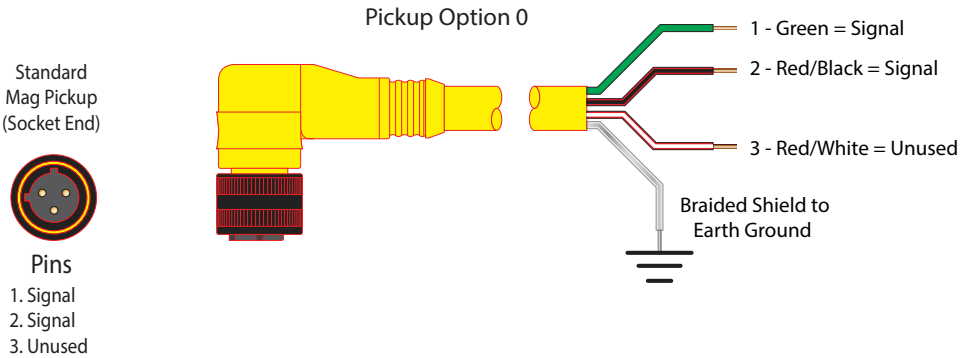

Figure 3: Wiring for NEMA 6 magnetic pickups

Standard
Mag Pickup
(Socket End)



Pins
A = Signal
B = Signal

Pickup Option 2 & 6

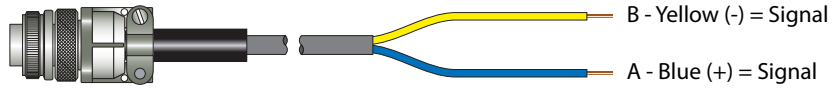

Amplified
Mag Pickup
(Socket End)



Pins
A = Power
B = Common
C = Output Signal

Pickup Option 3

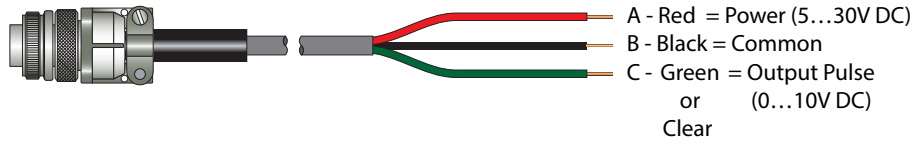
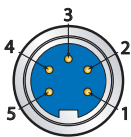

Figure 4: Wiring for non-NEMA 6 magnetic pickups

Active Sensor
4...20 mA
(Socket End)



Pins
1 = Loop (+)
2 = Loop (-)
3 = N/C
4 = N/C
5 = N/C

Pickup Option 4

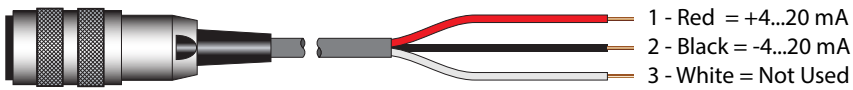

Active Sensor
0...5V DC
(Socket End)

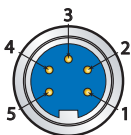

Pins
1 = 10...30V DC
2 = 0...5V DC Output
3 = Ground
4 = N/C
5 = N/C

Pickup Option 8



Figure 5: Wiring for active magnetic pickups

OPERATIONAL STARTUP

Follow this procedure to start the meter:

⚠ WARNING

MAKE SURE THAT FLUID FLOW HAS BEEN SHUT OFF AND PRESSURE IN THE LINE RELEASED BEFORE ATTEMPTING TO INSTALL THE METER IN AN EXISTING SYSTEM.

1. After installing the meter, close the isolation valves and open the bypass valve.
2. Flow liquid through the bypass valve for sufficient time to eliminate any air or gas in the flow line.
3. Open the upstream isolating valve slowly to eliminate hydraulic shock while charging the meter with the liquid.
4. Open the valve to full open.

⚠ CAUTION

HIGH VELOCITY AIR OR GAS MAY DAMAGE THE INTERNAL COMPONENTS OF THE METER.

5. Open the downstream isolating valve so the meter can operate properly.
6. Close the bypass valve to the fully closed position.
7. Adjust the downstream valve to provide the required flow rate through the meter.

NOTE: The downstream valve may be used as a control valve.

METER REPAIR AND CLEANING

Repair Kits

Each FloClean repair kit is factory calibrated for accuracy throughout the entire flow range. Each kit is complete and includes a new K-factor, which is the calibrated number of pulses generated by each gallon of liquid. This K-factor is used to recalibrate the monitor or other electronics for accurate output data.

Turbine Repair Kits Part Numbers

Bore Size	Ferrule Size	Repair Kit Fits Meter Part Number	Repair Kit Part Number
3/8 in. (9.53 mm)	0.984 in. (24.99 mm)	B16D-003A-XXX	B16D-K03A
1/2 in. (12.7 mm)	0.984 in. (24.99 mm)	B16D-005A-XXX	B16D-K05A
3/4 in. (19.05 mm)	0.984 in. (24.99 mm)	B16D-007A-XXX	B16D-K07A
1/2 in. (12.7 mm)	1.984 in. (50.39 mm)	B16D-105A-XXX	B16D-K05A
3/4 in. (19.05 mm)	1.984 in. (50.39 mm)	B16D-107A-XXX	B16D-K07A
7/8 in. (22.23 mm)	1.984 in. (50.39 mm)	B16D-108A-XXX	B16D-K08A
1 in. (25.4 mm)	1.984 in. (50.39 mm)	B16D-110A-XXX	B16D-K10A
1-1/2 in. (38.1 mm)	1.984 in. (50.39 mm)	B16D-115A-XXX	B16D-K15A
2 in. (50.8 mm)	3.047 in. (77.39 mm)	B16D-220A-XXX	B16D-K20A

Service Procedures

WARNING

HIGH-PRESSURE LEAKS ARE DANGEROUS AND CAUSE PERSONAL INJURY. MAKE SURE THAT FLUID FLOW HAS BEEN SHUT OFF AND PRESSURE IN THE LINE RELEASED BEFORE ATTEMPTING TO REMOVE THE METER.

3-A Turbine Disassembly and Cleaning Procedure

See *Figure 6* for relative positions of the repair kit components.

1. Remove the magnetic pickup from the meter body.
2. Remove the retaining ring from one end of the meter.
3. Keeping the meter upright (pickup port at the top), remove the rotor support from the body, taking care not to rotate it in the process. If the rotor support is jammed in the body, use a pair of pliers or vice grips to break it free.
4. Hold the rotor support over a suitable container and rotate it through 180°. The thrust ball will drop out. Do not lose the ball.
5. Remove the rotor assembly.
6. Remove the second retaining ring from the opposite side of the meter.
7. Repeat steps 3 and 4 for the remaining rotor support.
8. Identify parts and flow direction to match with original meter body.
9. Clean and/or sanitize parts to meet appropriate sanitary standards.

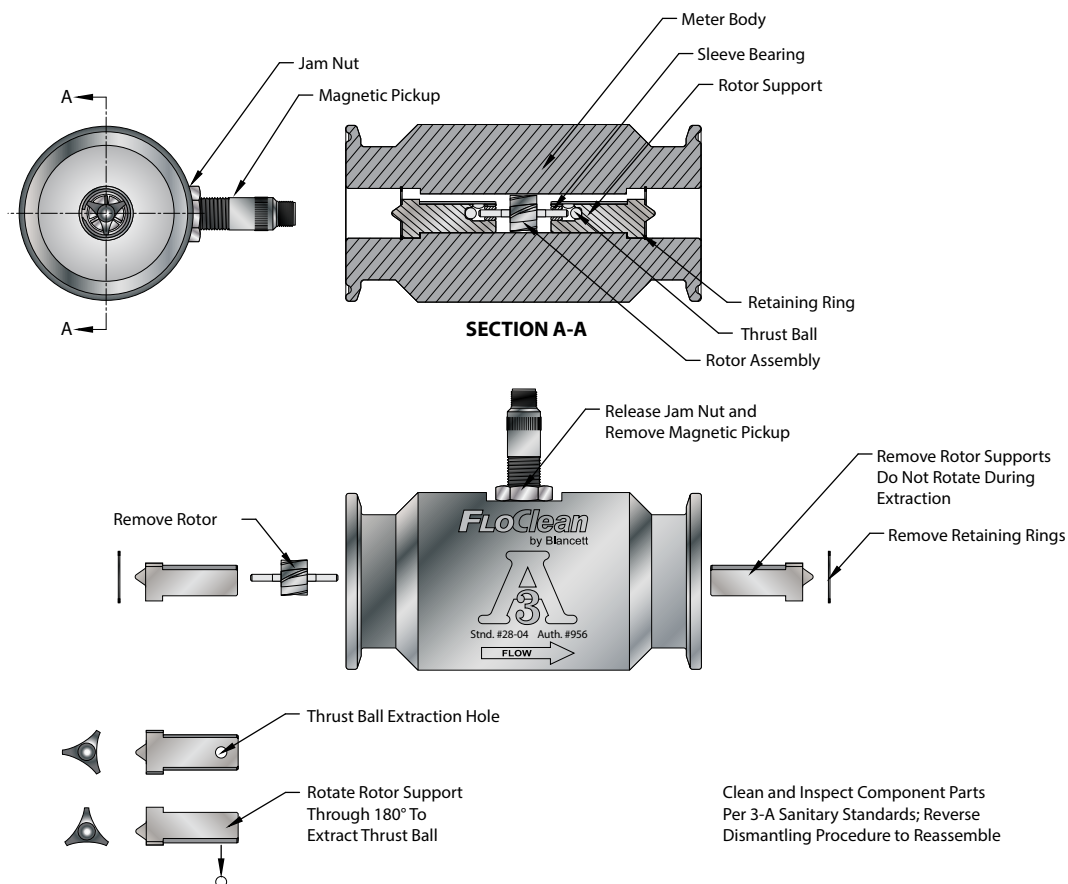

Figure 6: Positions of repair kit components

B16D SERIES (COP/SOP) 3-A TURBINE INSTALLATION

NOTE: This procedure applies to installation of replacement turbine repair kits and re-installation of cleaned or sanitized turbine.

IMPORTANT

Before reassembly, note the weep holes on each rotor support. These weep holes must be facing down toward the bottom of the meter body when installed.

The meter must be reassembled with the arrowheads on the rotor pointed in the direction of fluid flow. The magnetic pickup side of the body signifies the up position. This is the position that the repair kit was calibrated. Due to the polished surfaces, there are no arrows on the rotor support to indicate which rotor support is to be placed upstream or downstream. Install the repair kit as it was received in the box, using the arrow on the rotor to determine the placement of the rotor support.

1. If required by process procedures, clean the meter prior to installing it.
2. Drop a thrust ball into a rotor support through the hole in the side.
3. Insert the rotor support into the meter body.
4. Keep the thrust bearing hole pointed upwards to keep the ball in place.
5. Secure a retaining ring in the groove. Be sure that the retaining ring is completely installed in the groove.
6. Drop a thrust ball into second rotor support through the hole in the side.
7. Locate the rotor in the support sleeve bearing.
8. Insert the rotor support and the rotor into the meter body and the first support sleeve bearing.
9. Keep the thrust bearing hole pointed upwards to keep the ball in place.
10. Secure the second retaining ring in the groove. Be sure that the retaining ring is completely installed in the groove.

CAUTION

EXCESS AIR PRESSURE MAY DAMAGE THE ROTOR AND BEARINGS BY OVER-SPIN.

11. Check the meter by blowing air through the assembly. If the rotor does not turn freely, the meter should be disassembled and checked for anything that would obstruct movement of the rotor.
12. Install the magnetic pickup.

NOTE: After installing the new repair kit, the electronics will need re-calibration. Refer to the electronics' installation and operation manual. If there are any questions on re-calibration, contact Blancett at 1.800.235.1638 or contact the manufacturer of the electronics.

TROUBLESHOOTING GUIDE

Issue	Possible Cause	Remedy
Meter indicates higher than actual flow rate	<ul style="list-style-type: none"> • Cavitation • Debris on rotor support • Build up of foreign material on meter bore • Gas in liquid 	<ul style="list-style-type: none"> • Increase back pressure • Clean meter • Clean meter • Install gas eliminator ahead of meter
Meter indicates lower than actual flow rate	<ul style="list-style-type: none"> • Debris on rotor • Worn bearing • Viscosity higher than calibrated 	<ul style="list-style-type: none"> • Clean meter and add filter • Install new repair kit • Recalibrate monitor
Erratic system indication, meter alone works well (remote monitor application only)	Ground loop in shielding	Ground shield one place only. Look for internal electronic instrument ground. Reroute cables away from electrical noise.
Indicator shows flow when shut off	Mechanical vibration causes rotor to oscillate without turning	Isolate meter
No flow indication, full or partial open position	Fluid shock, full flow into dry meter or impact caused bearing separation or broken rotor shaft	Rebuild meter with repair kit and recalibrate monitor. Move to location where meter is full on startup or add downstream flow control valve.
Erratic indication at low flow, good indication at high flow	Rotor has foreign material wrapped around it	Clean meter and add filter
No flow indication	Faulty pickup	Replace pickup
System works perfect, except indicates lower flow over entire range	Bypass flow, leak	Repair or replace bypass valves or faulty solenoid valves
Meter indicating high flow, upstream piping at meter smaller than meter bore	Fluid jet impingement on rotor	Change piping
Opposite effects of above	Viscosity lower than calibrated	Change temperature, change fluid or recalibrate meter

3-A CERTIFICATE

ISSUE DATE: March 19, 1998

CERTIFICATE AUTHORIZATION NUMBER: 956



THIS IS TO CERTIFY THAT

Badger Meter, Inc.

PO Box 245036, Milwaukee, WI 53224-9536

is hereby authorized to continue to apply the
3-A Symbol to the models of equipment, conforming to 3-A Sanitary Standards for:

Number 28-04
28-04 (Flow Meters)

set forth below

COP Models: Turbine Flow Meters - Models #B/BP/BFC/BAW16D-
003A/005A/007A/105A/107A/108A/110A/115A/220A-xxx

VALID THROUGH: **December 31, 2017**

Timothy R. Rugh
Executive Director
3-A Sanitary Standards, Inc.

The issuance of this process certificate for the listed Accepted Practices is based upon the voluntary certification, by the applicant for it, that the equipment listed above conforms fully with the 3-A Accepted Practice(s) designated. Legal responsibility for conformance is solely that of the holder of this Process Certificate, and 3-A Sanitary Standards, Inc. does not warrant that the holder of a certificate at all times conforms with the provisions of the said 3-A Accepted Practice(s). This in no way affects the responsibility of 3-A Sanitary Standards, Inc. to take appropriate action in such cases in which evidence of nonconformance had been established.

NEXT TPV INSPECTION/REPORT DUE: **May 2021**

SPECIFICATIONS

Physical	Body/Internal Wetted Parts	316L stainless steel
	Bearings	Nickel bindery tungsten carbide
	Turbine	Nickel plated CD4MCU stainless steel
	Shaft	Nickel bindery tungsten carbide
	Connections	Sanitary clamp ends
Electrical	Pickup (option 0)	NEMA 6; -150...300° F (-100...149° C)
Accuracy	Accuracy	±1% of reading
	Repeatability	±0.1%
Certifications		
Construction	Temperature	-150...300° F (-101...149° C)
	Pressure Rating	1000 psi maximum (rating based on Tri-Clamp sanitary connection)
	Corrosion	Contact Blancett to determine if operating liquid is compatible with materials of construction

FloClean Flow Rate Chart

Ferrule Size	Flow Ranges		K-factor Pulses/Gal
	gpm	lpm	
0.984 in. (24.99 mm)	0.6...3.0	2.3...11.4	20,000
0.984 in. (24.99 mm)	0.75...7.5	2.8...28.4	13,000
0.984 in. (24.99 mm)	2.0...15.0	7.5...56.8	2750
1.984 in. (50.39 mm)	0.75...7.5	2.8...28.4	13,000
1.984 in. (50.39 mm)	2.0...15.0	7.5...56.8	2750
1.984 in. (50.39 mm)	3.0...30.0	11.4...113.5	2686
1.984 in. (50.39 mm)	5.0...50.0	19.0...190.0	870
1.984 in. (50.39 mm)	15.0...180.0	56.8...681.4	330
3.047 in. (77.39 mm)	40.0...400.0	151.4...1514.2	52

DIMENSIONS AND DRAWING

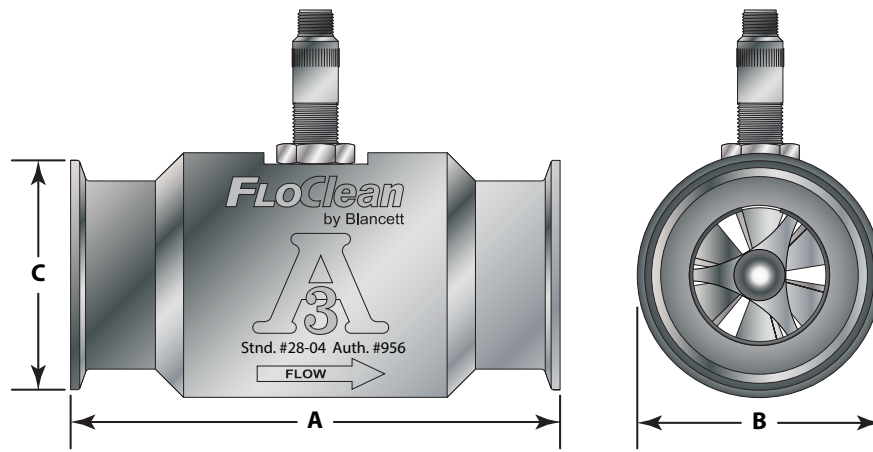

Part No.	A	B	C (Ferrule Size)
B16D-0XXA-XXX	3.00 in. (76.2 mm)	1.46 in. (37.1 mm)	0.984 in. (25.0 mm)
B16D-1XXA-XXX	4.00 in. (101.6 mm)	2.00 in. (50.8 mm)	1.984 in. (50.4 mm)
B16D-1XXA-XXX ¹	6.25 in. (158.8 mm)	2.33 in. (59.2 mm)	1.984 in. (50.4 mm)
B16D-2XXA-XXX	6.50 in. (165.1 mm)	3.20 in. (81.3 mm)	3.047 in. (77.4 mm)

¹ 15.0...180.0 gpm flow range only.

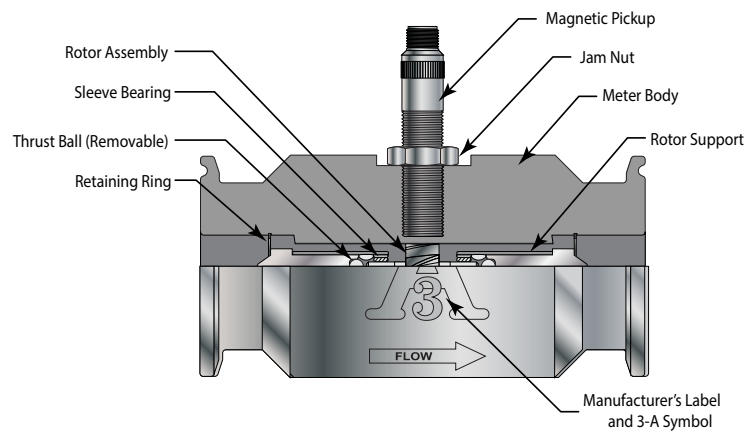

MODEL NUMBERS

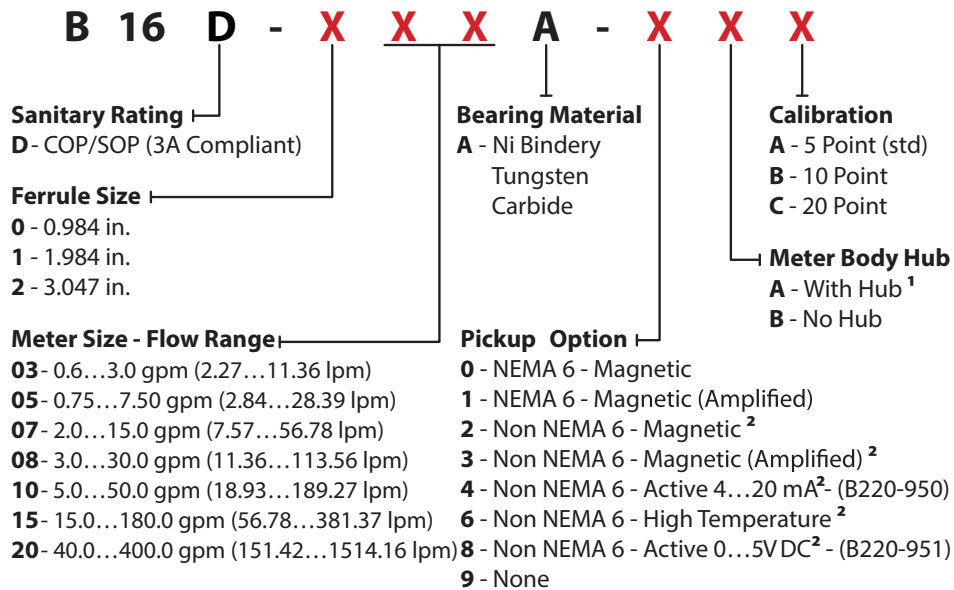

¹1/2 in. hub for body size 0; 1 in. hub for body sizes 1 and 2.

² Indoor use only.