

SOL series

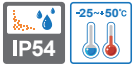

- Applicable in road construction sites with a limited power supply
- Applicable on vehicles that require a warning light at night
- Can be used to display vehicle position in dark residential parking areas



S80SOL

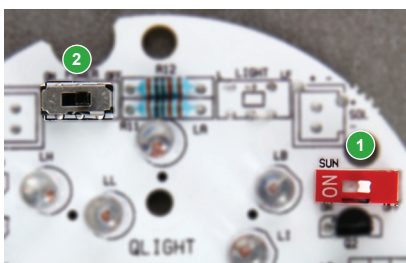

- Sun Switch**
Automatically turns on the light when darkness is detected.
Factory default is set to OFF.
- Power Switch**
ON/OFF power switch that prevents discharge prior to use.
Factory default is set to OFF.

Solar Rechargeable LED Flashing Signal Lights

SOL solar light model does not require external power supply or wiring!

Features High Energy Efficiency and Longevity

SOL Solar light models can be used in environmental conditions where power supply is limited or wiring is difficult.

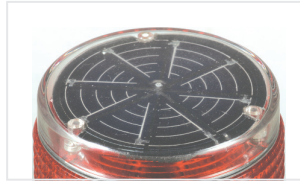

Features High Energy Efficiency and Longevity

Qlight's solar rechargeable signal lights have a special design that mounts the solar panels inside a structure that minimizes adverse effects such as dust and moisture. This improves the efficiency and extends the lifetime of the product.

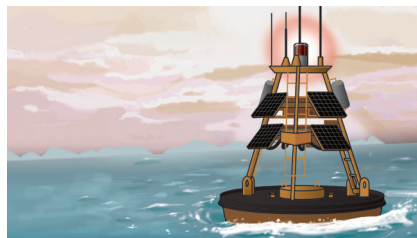

High-tide maritime surveillance systems



Low-speed night vehicle operation

Common Specifications(S80SOL/ S100SOL/ S125SOL)

- Solar rechargeable LED flashing signal light that does not require an external power supply or wiring
- Built-in Darkness Detection System that automatically begins to operate when darkness is detected
- Fully enclosed structure that can withstand storm and severe dust environments (IP54)
- Prevents discharge using a built-in power switch
- Flashing Rate : 60-80 flashes/min
- Materials : Lens-AS, Body-ABS, Reflector-Heat resistant ABS
- Ambient operating temperature : -25°C to +50°C
- Protection rating : IP54
- Certificates : CE Compliant

S80SOL Ø80mm Solar Rechargeable LED Flashing Signal Light

- 80mm Compact model
- A single charge (8 hours) serves up to 30 hours of continuous operation

Model number	Battery Voltage	Battery Capacity	Continuous operating time with no charge	Certificates	Weight	Color Options
S80SOL	2.4V	0.77Ah	30Hr	CE	0.27kg	<ul style="list-style-type: none"> • R-Red • A-Amber

Technical Diagram

(Units : mm)

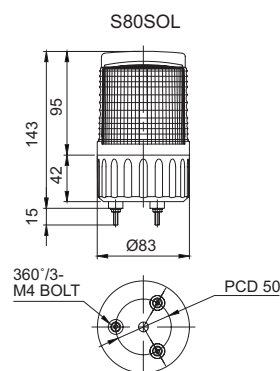

SOL series

Solar Rechargeable LED Flashing Signal Lights



S100SOL

S100SOL Ø100mm Solar Rechargeable LED Flashing Signal Light

- Ø100mm model for general purpose
- 40 hours operation continuous by 1 time recharge(8 hours)

Model number	Battery Voltage	Battery Capacity	Continuous operating time with no charge	Certificates	Weight	Color Options
S100SOL	2.4V	0.77Ah	40Hr	CE	0.41kg	<ul style="list-style-type: none"> • R-Red • A-Amber



Technical Diagram

(Units : mm)

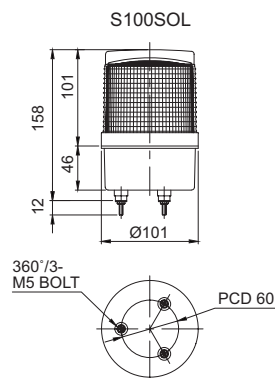

S125SOL

S125SOL Ø125mm Solar Rechargeable LED Flashing Signal Light

- Ø125mm standard item
- 50 hours of continuous operation from 1 time recharge(8 hours)

Model number	Battery Voltage	Battery Capacity	Continuous operating time with no charge	Certificates	Weight	Color Options
S125SOL	2.4V	0.70Ah	50Hr	CE	0.51kg	<ul style="list-style-type: none"> • R-Red • A-Amber



Technical Diagram

(Units : mm)

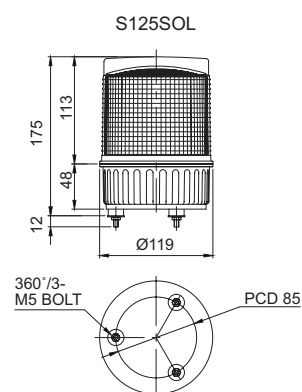

Ordering Specification

S80SOL	-	R
[Model number]		[Color]
<ul style="list-style-type: none"> • S80SOL • S100SOL • S125SOL 		<ul style="list-style-type: none"> • R-Red • A-Amber



Accessories

- Magnetic mounting bracket
- Wall mount bracket options : Bracket structure allows for threading through the bracket hole or into the wall mount

- S80SOL



Wall Mount Bracket
TWS80



Wall Mount Bracket
TWA80

- S100SOL/ S125SOL



Wall Mount Bracket
SWP125



Wall Mount Bracket
SWM125

ООО "РусАвтоматизация"

454010 г. Челябинск, ул. Гагарина 5, оф. 507
 тел. 8-800-775-09-57 (звонок бесплатный), +7(351)799-54-26, тел./факс +7(351)211-64-57
info@rusautomation.ru; rusavtomatizacija.pf; www.rusautomation.ru