



Operating instructions  
Capacitive sensors

**efector150**<sup>®</sup>

**KG (M18)**

**UK**

80005165 / 00 09 / 2013

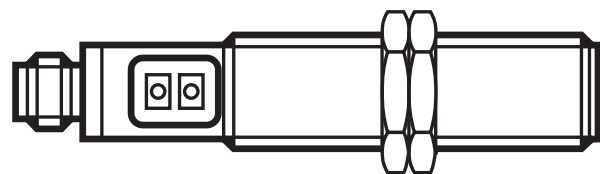

# Content

1 Preliminary note .....	3
1.1 Symbols used .....	3
2 Safety instructions .....	3
3 Functions and features .....	3
4 Installation.....	4
4.1 Notes on flush and non-flush installation .....	4
5 Electrical connection.....	5
5.1 Wiring.....	5
6 Operating and display elements .....	6
7 Settings.....	7
7.1 Basic teach empty state .....	7
7.2 Adjustment teach full state.....	7
7.3 Modified basic teach empty state .....	8
7.4 Locking / unlocking .....	9
7.5 IO-Link .....	10
7.5.1 General information .....	10
7.5.2 Device-specific information.....	10
7.5.3 Parameter setting tools.....	10
8 Operation .....	10
9 Maintenance, repair and disposal.....	10
10 Definitions.....	11

# 1 Preliminary note

## 1.1 Symbols used

- Operating elements are indicated as follows:  
Example: **[OUT OFF]** = pushbutton "OUT OFF"
- An instruction is indicated by "▶":  
Example: ▶ Check whether the unit operates correctly.
- A reaction to the action is indicated by ">":  
Example: > yellow LED lights.



Important note

Non-compliance can result in malfunction or interference.

UK

## 2 Safety instructions

- Please read the operating instructions prior to set-up of the unit. Ensure that the product is suitable for your application without any restrictions.
- The unit conforms to the relevant regulations and EC directives.
- Improper or non-intended use may lead to malfunctions of the unit or to unwanted effects in your application.
- Installation, electrical connection, set-up, operation and maintenance of the unit must only be carried out by qualified personnel authorised by the machine operator.

## 3 Functions and features

- Capacitive sensor for monitoring levels of liquids and dry bulk material.
- Automatic adjustment to the medium to be detected by means of programming buttons.

## 4 Installation

► Mount the unit as shown:

- In contact with the medium
- In case of liquids use a mounting adapter (e.g. E43900).

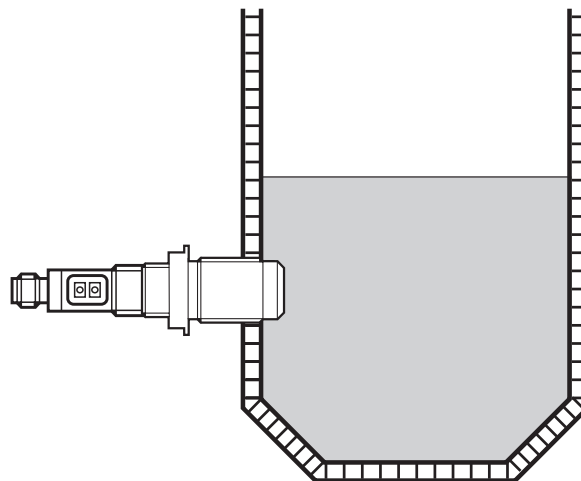
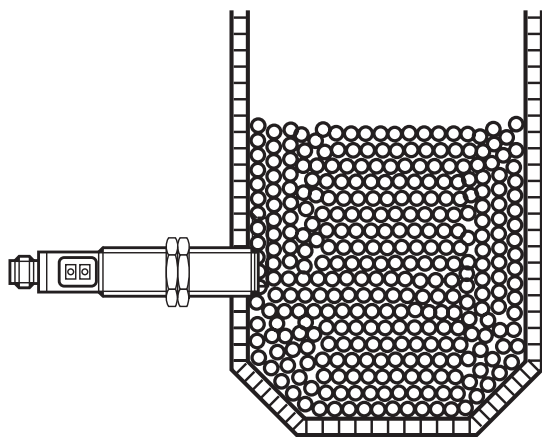

- Not in contact with the medium (only for non-metallic tanks)

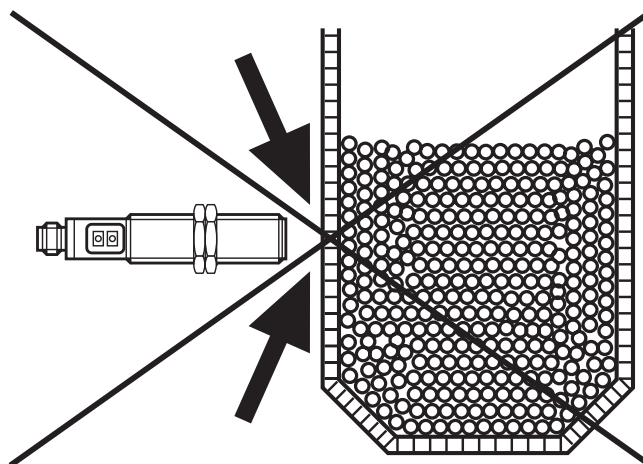
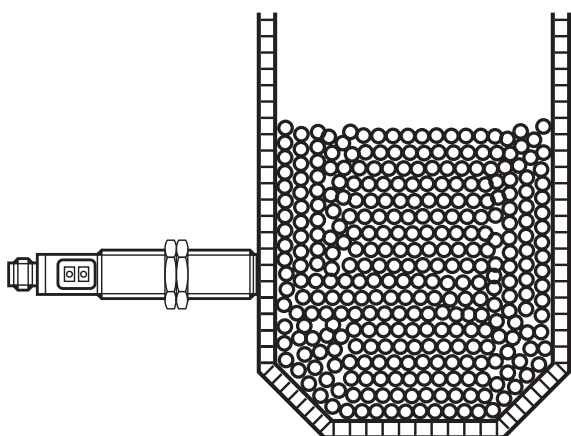

### 4.1 Notes on flush and non-flush installation

 For flush installation of non-flush units the sensor properties change and the sensor can remain permanently switched (loss of function).

## Free space around the sensing face

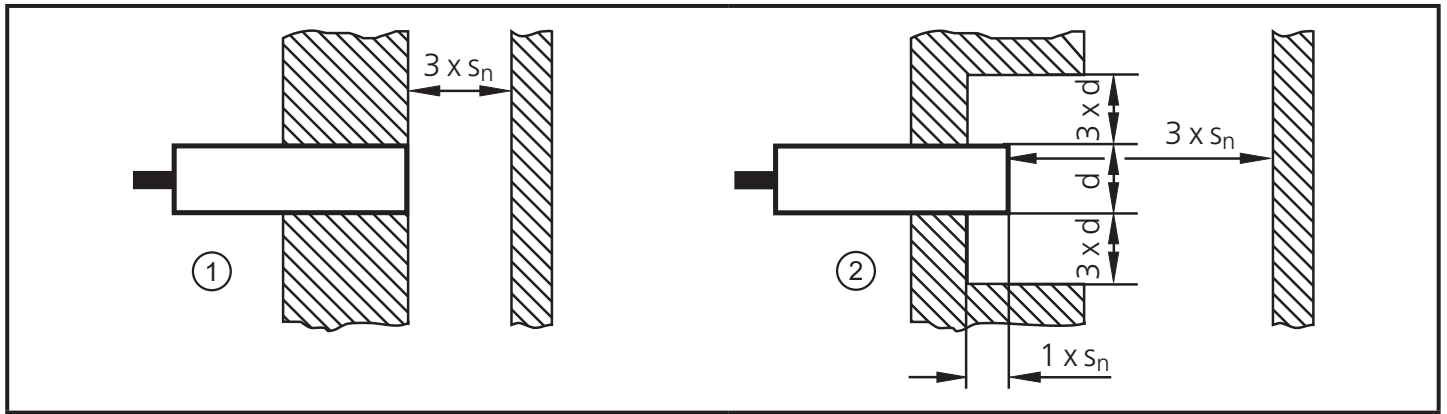

1: flush

2: non flush

UK

## Minimum distances when mounting several switches of the same type

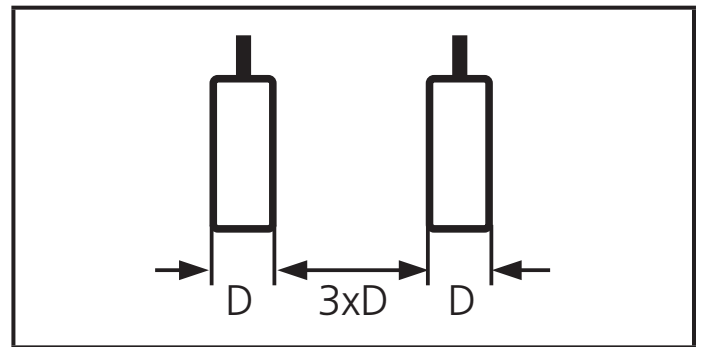
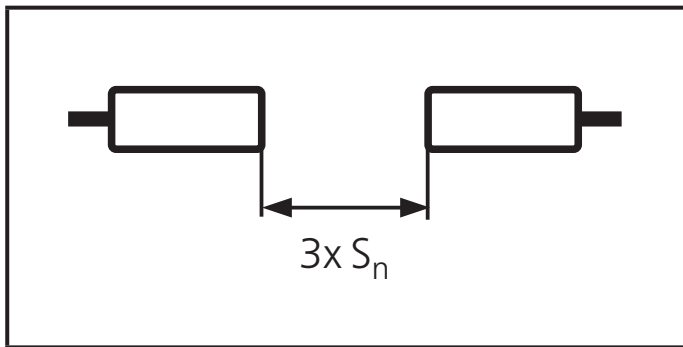

## 5 Electrical connection



The unit must be connected by a qualified electrician.

The national and international regulations for the installation of electrical equipment must be adhered to.

► Disconnect the installation from power and connect the unit.

### 5.1 Wiring

#### Positive switching (type ...FPKG...)

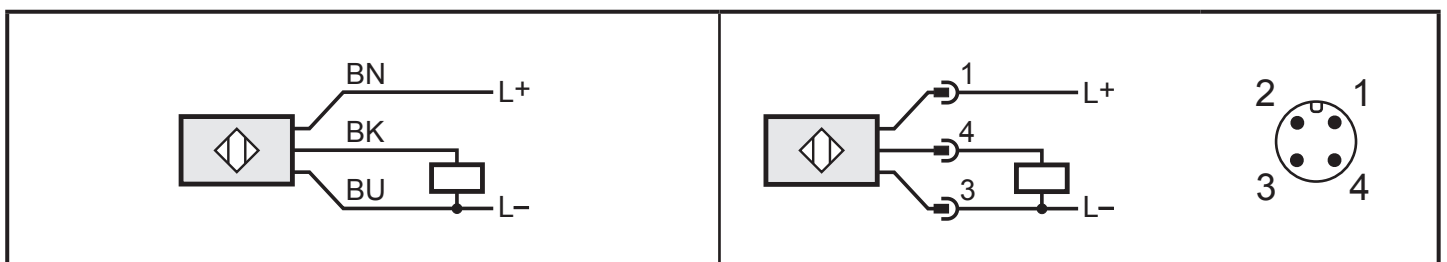

BN = brown, BK = black, BU = blue

## Output with autodetect, negative or positive switching (type ...FAKG...)

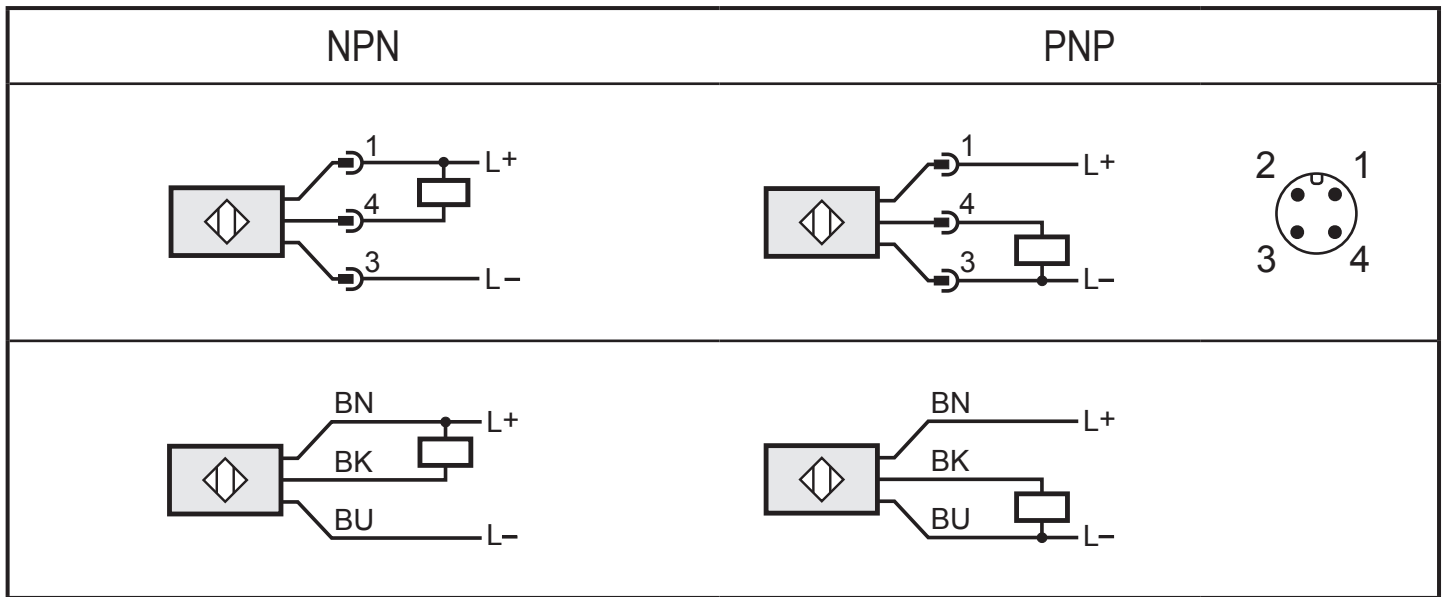

BN = brown, BK = black, BU = blue

On power up, the unit detects automatically if the output is connected to L- (= PNP) or to L+ (= NPN).

► Disconnect the unit to acknowledge a change of the load connection.

## 6 Operating and display elements

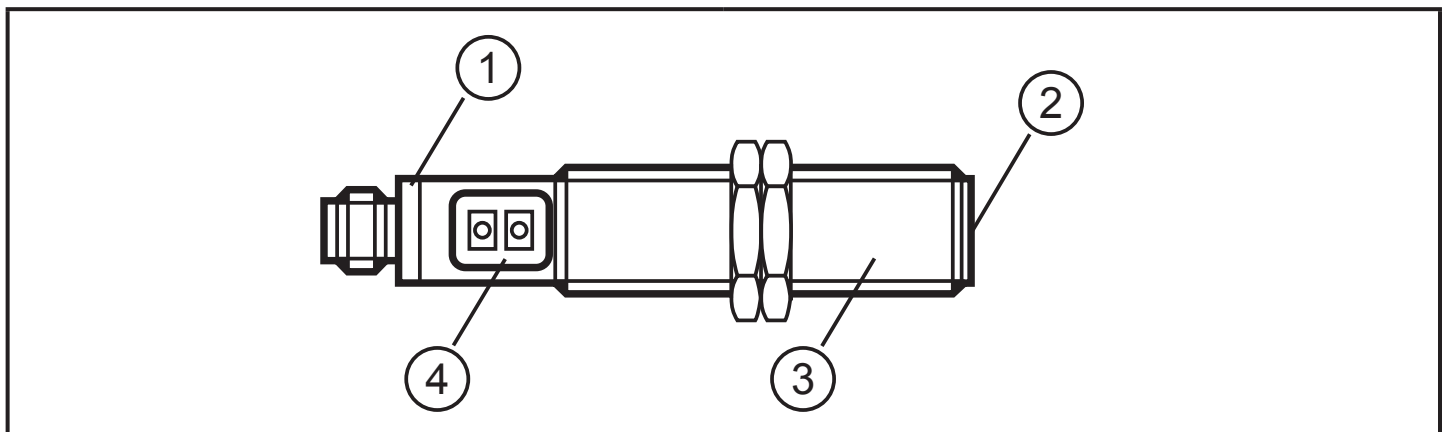

1: LED ring yellow  
2: Sensing face

3: Threaded sleeve  
4: Programming buttons

# 7 Settings

## 7.1 Basic teach empty state

Using the basic teach empty state the unit suppresses the installation environment. The basic teach empty state resets the unit, an adjustment teach already carried out is deleted.

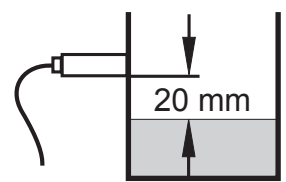
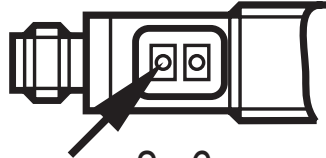
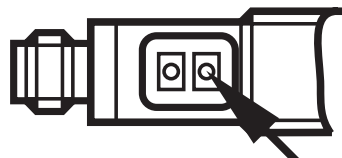
<p>▶ Empty the tank until the level is at least 20 mm below the sensor.</p>	
<p>Set the unit as normally open (output closes when the tank is full):</p> <p>▶ Press [<b>OUT OFF</b>] for min. 2 s (max. 6 s).</p> <p>&gt; While pressing the pushbutton, the LED flashes slowly. After releasing the pushbutton, the LED goes out.</p>	 <p>2...6 s</p>
<p>Set the unit as normally closed (output opens when the tank is full):</p> <p>▶ Press [<b>OUT ON</b>] for min. 2 s (max. 6 s).</p> <p>&gt; While pressing the pushbutton, the LED flashes slowly. After releasing the pushbutton, the LED lights continuously.</p>	 <p>2...6 s</p>

UK

The unit is now ready for operation. For the detection of media with a low dielectric constant (e.g. plastic granulates or oils) no further setting is required.

## 7.2 Adjustment teach full state

Necessary for aqueous media. The sensitivity of the unit is optimised. Later on, the adjustment teach full state can be repeated at any time, a basic teach empty state already carried out is not affected.

A basic teach empty state must be carried out prior to the adjustment teach full state (→ 7.1 Basic teach empty state)! If it is not possible to empty the tank, a basic teach empty state can be carried out by simulating the empty state (e.g. adjustment when not installed, adjustment at a higher position). For optimum function it is necessary to carry out the "modified basic teach empty state" (→ 7.3 Modified basic teach empty state) when the tank is emptied the next time.

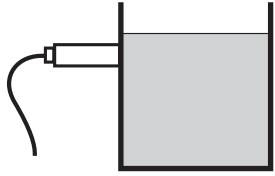
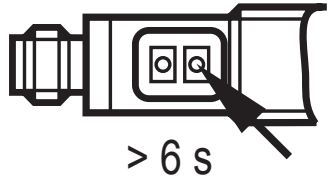
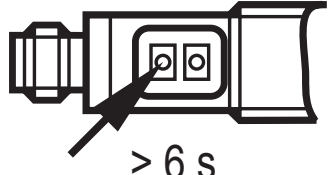
<ul style="list-style-type: none"> <li>▶ Fill the tank until the sensing face of the unit is covered.</li> <li>&gt; For NO the LED lights, for NC it goes out.</li> </ul>	
<p>Set the unit as normally open (output closes when the tank is full):</p> <ul style="list-style-type: none"> <li>▶ Press [<b>OUT ON</b>] for min. 6 s.</li> <li>&gt; While pressing the pushbutton, the LED first flashes slowly, after 6 s more quickly. After releasing the pushbutton, the LED lights continuously.</li> </ul>	
<p>Set the unit as normally closed (output opens when the tank is full):</p> <ul style="list-style-type: none"> <li>▶ Press [<b>OUT OFF</b>] for min. 6 s.</li> <li>&gt; While pressing the pushbutton, the LED first flashes slowly, after 6 s more quickly. After releasing the pushbutton, the LED goes out.</li> </ul>	

### 7.3 Modified basic teach empty state

Recommended for deposits in the tank. Deposits are largely suppressed. This is also recommended if it has not been possible to carry out a basic teach empty state (e.g. if the sensor is set up on a full tank; details: → 7.2 Adjustment teach full state).

Later on, the modified basic teach empty state can be repeated at any time, an adjustment teach full state already carried out is not affected.

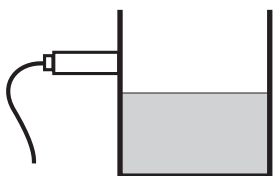
<ul style="list-style-type: none"> <li>▶ Empty the tank until the level is below the sensing face of the unit.</li> <li>&gt; For NO the LED goes out, for NC the LED lights.</li> </ul>	
---	---

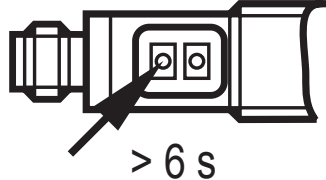
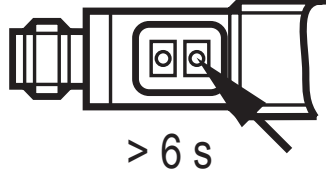

<p>Set the unit as normally open (output closes when the tank is full):</p> <ul style="list-style-type: none"> <li>▶ Press [<b>OUT OFF</b>] for min. 6 s.</li> <li>&gt; While pressing the pushbutton, the LED first flashes slowly, after 6 s more quickly. After releasing the pushbutton, the LED goes out.</li> </ul>	
<p>Set the unit as normally closed (output opens when the tank is full):</p> <ul style="list-style-type: none"> <li>▶ Press [<b>OUT ON</b>] for min. 6 s.</li> <li>&gt; While pressing the pushbutton, the LED first flashes slowly, after 6 s more quickly. After releasing the pushbutton, the LED lights continuously.</li> </ul>	

UK

## 7.4 Locking / unlocking

The unit can be electronically locked to protect it against unintentional setting.

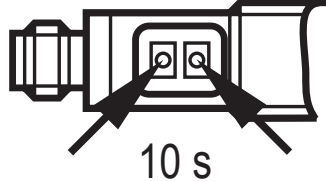
<ul style="list-style-type: none"> <li>▶ To lock press [<b>OUT ON</b>] and [<b>OUT OFF</b>] simultaneously for 10 s.</li> <li>&gt; Acknowledgement: LED state (yellow) changes for a short time (the lit LED goes out briefly or the LED which is not lit lights briefly).</li> <li>▶ To unlock repeat this step.</li> </ul>	
--	---

If the unit does not react, it may be locked.

## 7.5 IO-Link

### 7.5.1 General information

This unit has an IO-Link communication interface which requires an IO-Link-capable module (IO-Link master) for operation.

The IO-Link interface enables direct access to the sensor values and parameters and provides the possibility to set the parameters of the unit during operation.

In addition communication is possible via a point-to-point connection with a USB adapter cable.

You will find more detailed information about IO-Link at [www.ifm.com/uk/io-link](http://www.ifm.com/uk/io-link).

### 7.5.2 Device-specific information

You will find the IODDs necessary for the configuration of the IO-Link device and detailed information about sensor values, diagnostic information and parameters in the overview table at [www.ifm.com/uk/io-link](http://www.ifm.com/uk/io-link).

### 7.5.3 Parameter setting tools

You will find all necessary information about the required IO-Link hardware and software (e.g. ifm LINERECORDER SENSOR ZGS210) at [www.ifm.com/uk/io-link](http://www.ifm.com/uk/io-link).

## 8 Operation

Check whether the unit operates correctly. Bring about a sensor response by taking suitable measures.

Display by LEDs (independent of the programmed output configuration):

LED yellow OFF:	switching output disabled
LED yellow ON:	switching output enabled

## 9 Maintenance, repair and disposal

The operation of the unit is maintenance-free. To ensure a correct function:

- Keep the sensing face and a clear space, if any, free from deposits and foreign bodies.

When removing the unit or changing the medium, a new adjustment might be necessary.

It is not possible to repair the unit.

After use dispose of the unit in an environmentally friendly way in accordance with the applicable national regulations.

# 10 Definitions

## **Active zone / active face**

Area above the sensing face in which the sensor reacts to the approach of the target.

## **Output function**

Normally open: object within the active zone - output switched.

Normally closed: object within the active zone - output blocked.

Programmable: choice between normally closed or normally open.

Positive switching: positive output signal (to L-).

Negative switching: negative output signal (to L+).

## **Power-on delay time**

The time the sensor needs to be ready for operation after application of the operating voltage (in the millisecond range).

## **Hysteresis**

Difference between the switch-on and the switch-off point.

## **Leakage current**

Current for the internal supply of 2-wire units; also flows through the load when the output is blocked.

## **Current consumption**

Current for the internal supply of 3-wire DC units.

## **Switch point drift**

Shifting of the switch point owing to changes of the operating conditions (e.g. temperature, pressure, air humidity).

## **Short-circuit protection**

ifm sensors which are protected against excessive current by means of a pulsed short-circuit protection. The inrush current of incandescent lamps, electronic relays and low resistance loads may cause this protection to cut in and turn the sensor off!

## **Operating voltage**

The voltage range in which the sensor functions safely. A stabilised and smoothed direct voltage should be used! Take into account residual ripple!

UK