

Operating instructions
Pressure sensor

efector500[®]

PE70xx

UK

706182 / 01 08 / 2012

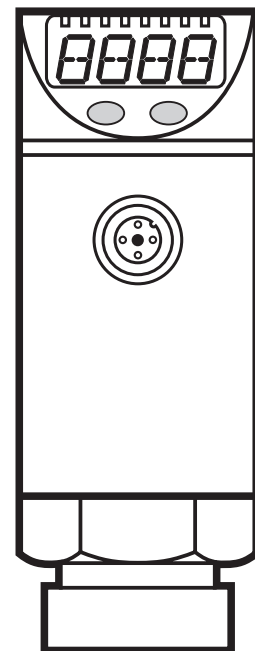

Contents

1	Preliminary note.....	3
1.1	Symbols used	3
2	Safety instructions	3
3	Functions and features	3
4	Function.....	4
4.1	Communication, parameter setting, evaluation	4
4.2	Switching function.....	4
4.3	Diagnostic function	5
5	Installation.....	5
6	Electrical connection.....	6
7	Operating and display elements	7
8	Menu.....	8
8.1	Menu structure.....	8
8.2	Explanation of the menu	9
9	Parameter setting	10
9.1	General parameter setting.....	10
9.2	Configuring the display (optional)	12
9.3	Setting the output signals	12
9.3.1	Setting of the output function.....	12
9.3.2	Setting of the switching limits	12
9.4	User settings (optional)	13
9.4.1	Setting of a time delay for the switching signals.....	13
9.4.2	Setting of the output logic for the switching outputs	13
9.4.3	Setting of the damping for the switching outputs.....	13
9.5	Service functions	13
9.5.1	Reading the min./max. values for the system pressure.....	13
9.5.2	Reset all parameters to factory setting	13
10	Operation.....	14
10.1	Reading of the set parameters	14
10.2	Fault indication	14
10.3	Setting ranges	15

1 Preliminary note

1.1 Symbols used

- ▶ Instruction
- > Reaction, result
- [...] Designation of pushbuttons, buttons or indications
- Cross-reference



Important note:

Non-compliance can result in malfunctions or interference.

UK

2 Safety instructions

- Please read this document prior to set-up of the unit. Ensure that the product is suitable for your application without any restrictions.
- If the operating instructions or the technical data are not adhered to, personal injury and/or damage to property can occur.
- Check the compatibility of the product materials (→ chapter 12 Technical data) with the media to be measured in all applications.
- Use in gases at pressures > 25 bar only after contacting the manufacturer ifm.

3 Functions and features

The unit monitors the system pressure of machines and plants.

Applications

Type of pressure: relative pressure

Order no.	Measuring range		Permissible overpressure		Bursting pressure	
	bar	PSI	bar	PSI	bar	PSI
PE7002	0...100	0...1 450	300	4 350	650	9 400
PE7003	0...25	0...363	150	2 175	350	5 075
PE7004	-1...10	-14.5...145	75	1 087	150	2 175
PE7006	0...2.5	0...36.3	20	290	50	725
PE7007	0...1	0...14.5	10	145	30	450
PE7009	-1...1	-14.5...14.5	20	290	50	725

MPa = bar ÷ 10 / kPa = bar × 100



Avoid static and dynamic overpressure exceeding the given overload pressure by taking appropriate measures.

The indicated bursting pressure must not be exceeded.

Even if the bursting pressure is exceeded only for a short time, the unit may be destroyed. NOTE: Risk of injury!

Use in gases at pressures > 25 bar only after contacting the manufacturer ifm.

Cannot be used for oils.

4 Function

4.1 Communication, parameter setting, evaluation

- The unit displays the current system pressure.
- It generates 2 output signals according to the parameter setting.

OUT1	• Switching signal for process value; IO-Link.
OUT2	2 options • Switching signal for process value. • Diagnostic signal (output 2 is inactive in case of a fault).

- The following functions are available via IO-Link (OUT1):
reading the current process value, changing the parameters and transferring them to other units of the same type using the FDT service program ifm Container or other parameter setting tools with IO-Link capability.
The program library of the available DTM objects and the IO Device Description (IODD) are available at www.ifm.com → Service → Download.

4.2 Switching function

OUTx changes its switching state if it is above or below the set switching limits (SPx, rPx). The following switching functions can be selected:

- Hysteresis function / normally open: [OUx] = [Hno] (→ fig. 1).
- Hysteresis function / normally closed: [OUx] = [Hnc] (→ fig. 1).

First the set point (SPx) is set, then the reset point (rPx) with the requested difference.

- Window function / normally open: [OUx] = [Fno] (→ fig. 2).
- Window function / normally closed: [OUx] = [Fnc] (→ fig. 2).

The width of the window can be set by means of the difference between SPx and rPx. SPx = upper value, rPx = lower value.

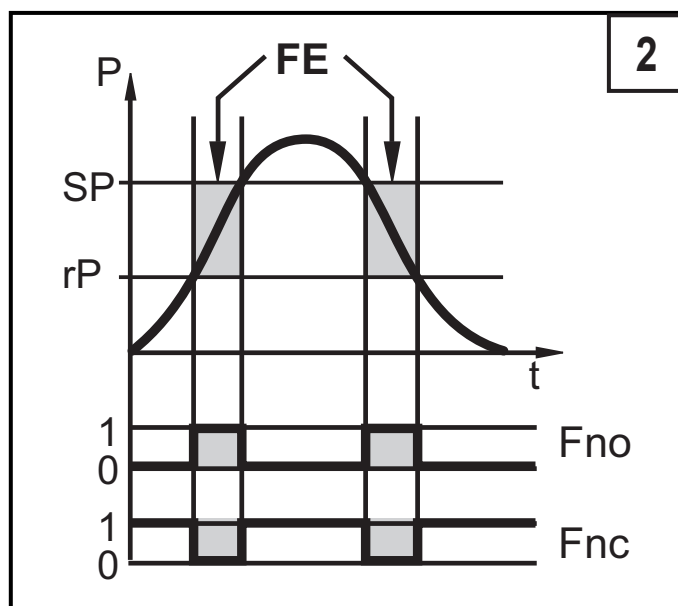
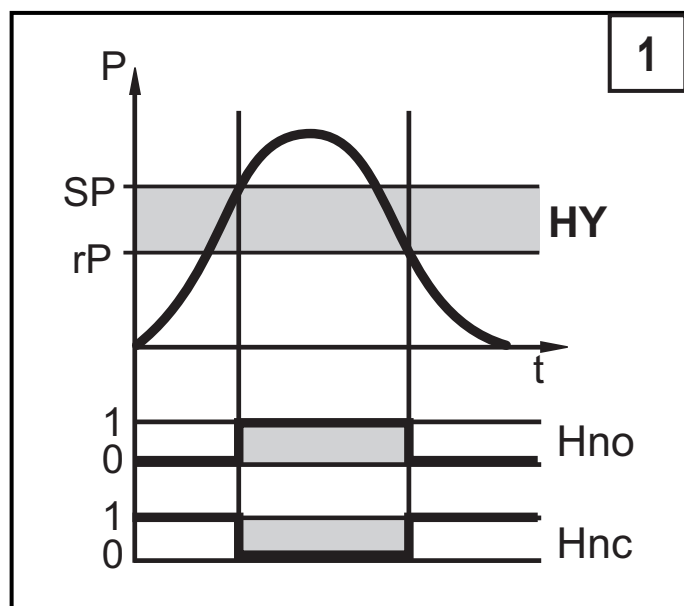

P = system pressure; HY = hysteresis; FE = window

4.3 Diagnostic function

Output 2 is used as diagnostic output based on the DESINA specification if [OU2] = [dESI].

- If there is no fault, the output is switched and carries UB+ (if P-n = PnP) or UB- (if P-n = nPn).
- In case of malfunctions in the following areas, the output is inactive:
 - Measuring cell defect,
 - short circuit in output 1

5 Installation



Before mounting and removing the sensor, make sure that no pressure is applied to the system.

- ▶ Insert the unit in a G $\frac{1}{4}$ process connection.
- ▶ Tighten firmly.

6 Electrical connection



The unit must be connected by a qualified electrician.

The national and international regulations for the installation of electrical equipment must be adhered to.

Voltage supply to EN50178, SELV, PELV.

- ▶ Disconnect power.
- ▶ Connect the unit as follows:

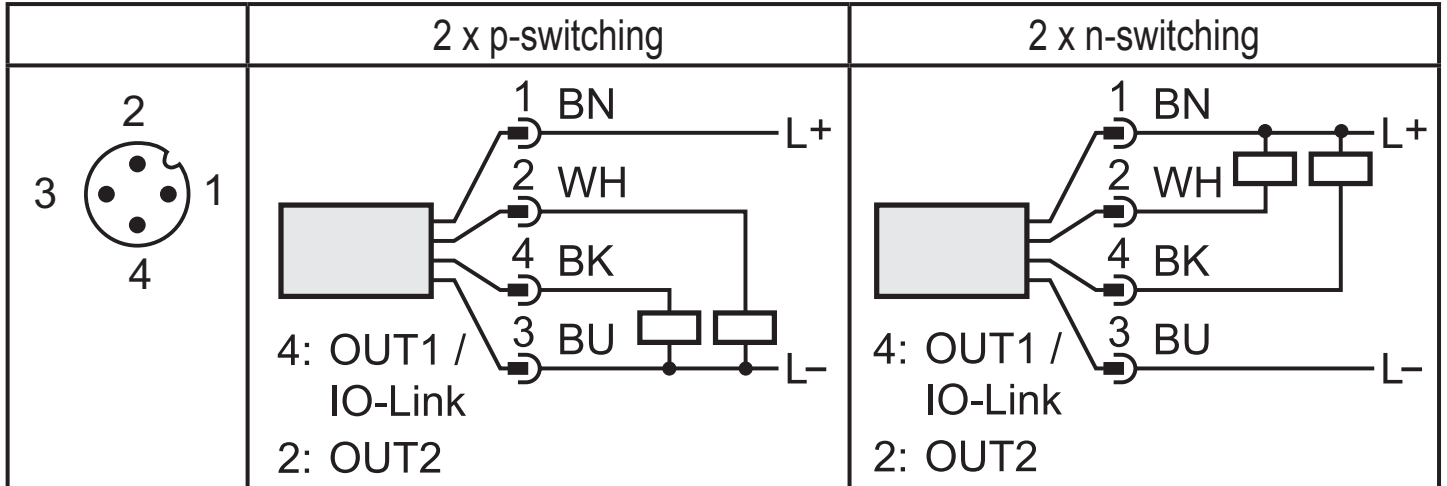

Pin 1	Ub+
Pin 3	Ub-
Pin 4 (OUT1)	• binary switching output pressure monitoring; IO-Link
Pin 2 (OUT2)	• binary switching output if [OU2] = [Hno], [Hnc], [Fno] or [Fnc] • diagnostic output if [OU2] = [dESI]

Core colours of ifm sockets:

1 = BN (brown), 2 = WH (white), 3 = BU (blue), 4 = BK (black)

7 Operating and display elements

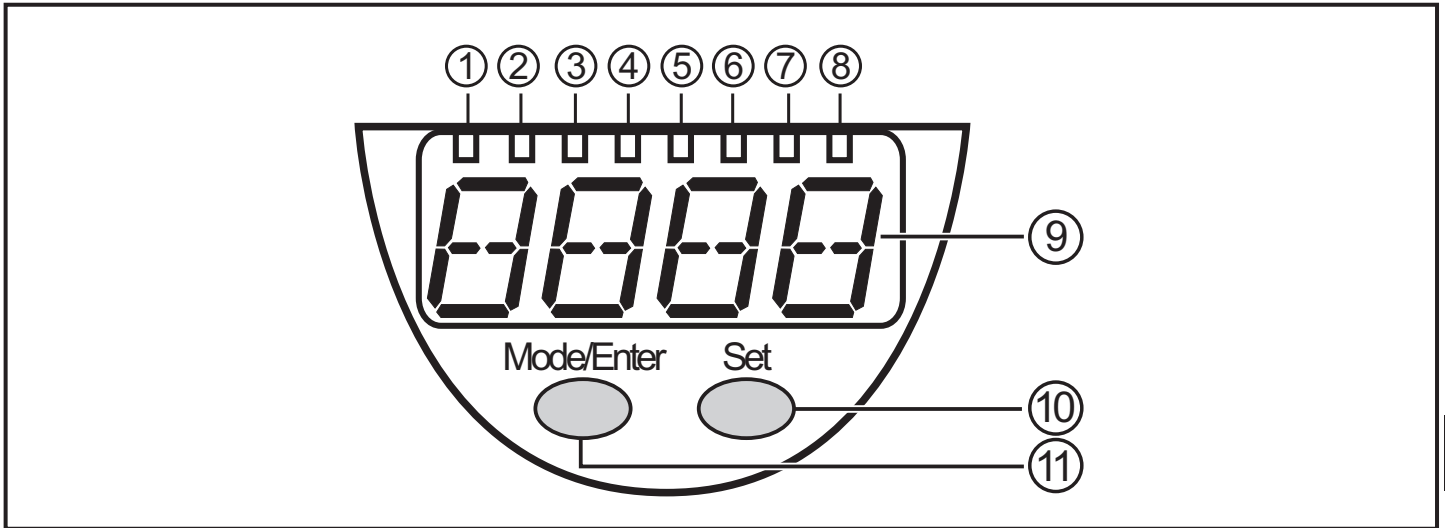

UK

1 to 8: Indicator LEDs

- LED 1 to LED 4 = system pressure in unit of measurement as indicated on the label.
- LED 4 not used for units with 3 adjustable units of measurement.
- LEDs 5 and 6 not used.
- LED 7, LED 8 = switching state of the corresponding output.

9: Alphanumeric display, 4 digits

- Indication of the current system pressure.
- Indication of the parameters and parameter values.

10: Set pushbutton

- Setting of the parameter values (scrolling by holding pressed, incremental by pressing briefly).

11: Mode/Enter pushbutton

- Selection of the parameters and acknowledgement of the parameter values.

8 Menu

8.1 Menu structure

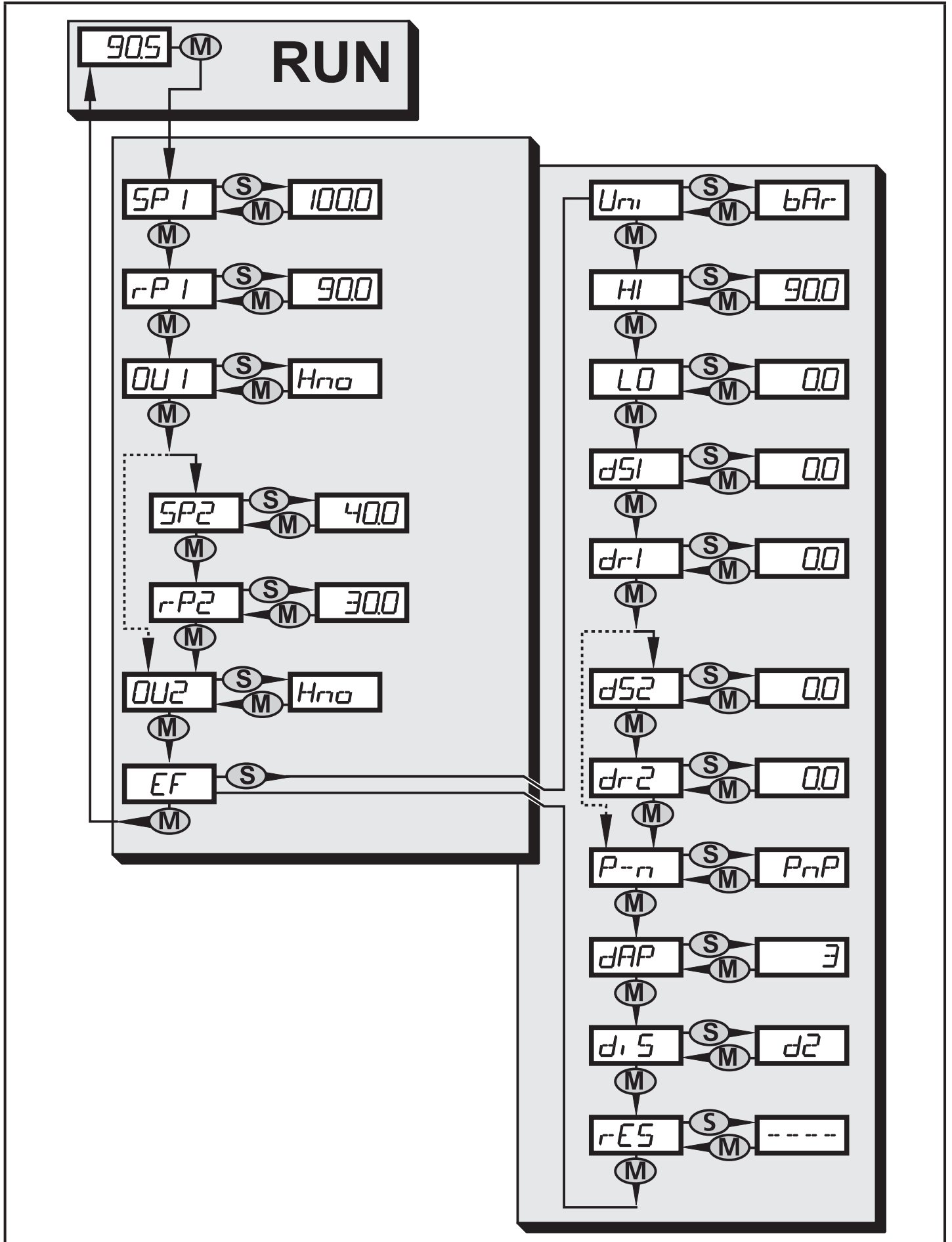

8.2 Explanation of the menu

SP1/rP1	Upper / lower limit value for system pressure at which OUT1 switches.
SP2/rP2	Upper / lower limit value for system pressure at which OUT2 switches.
OU1	Output function for OUT1: <ul style="list-style-type: none"> Switching signal for the pressure limit values: hysteresis function [H ..] or window function [F ..], either normally open [. no] or normally closed [. nc].
OU2	Output function for OUT2: <ul style="list-style-type: none"> Switching signal for the pressure limit values: hysteresis function [H ..] or window function [F ..], either normally open [. no] or normally closed [. nc]. Diagnostic signal [OU2] = dESI.
EF	Extended functions / opening of menu level 2.
Uni	Standard unit of measurement for system pressure.
HI	Maximum value memory for system pressure.
LO	Minimum value memory for system pressure (only PE7004 and PE7009).
dS1/dS2	Switch-on delay for OUT1 / OUT2.
dr1/dr2	Switch-off delay for OUT1 / OUT2.
P-n	Output logic: pnp / npn.
dAP	Damping for the switching outputs.
diS	Update rate and orientation of the display.
rES	Restore factory settings.

UK

9 Parameter setting

During parameter setting the unit remains in the operating mode. It continues its monitoring function with the existing parameters until the parameter setting has been completed.

9.1 General parameter setting

3 steps must be taken for each parameter setting:

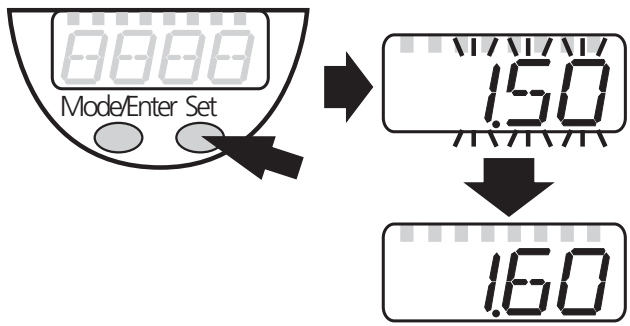
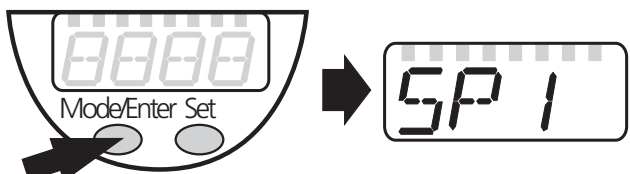
<p>1</p>	<p>Parameter selection</p> <ul style="list-style-type: none"> ▶ Press [Mode/Enter] until the requested parameter is displayed. 	 <p>The diagram shows a device with a display showing '0000' and two buttons labeled 'Mode/Enter' and 'Set'. An arrow points to the 'Mode/Enter' button. A second arrow points to the resulting display showing 'SP 1'.</p>
<p>2</p>	<p>Setting of the parameter value</p> <ul style="list-style-type: none"> ▶ Press [Set] and keep it pressed. > Current setting value of the parameter flashes for 5 s. > After 5 s: setting value is changed: incrementally by pressing the button once or continuously by keeping the button pressed. 	 <p>The diagram shows the device with '0000' on the display. An arrow points to the 'Set' button. A second arrow points to the display showing '150'. A third arrow points down to the display showing '160'.</p>
<p>Numerical values are incremented continuously. To reduce the value: let the display move to the maximum setting value. Then the cycle starts again at the minimum setting value.</p>		
<p>3</p>	<p>Acknowledgement of the parameter value</p> <ul style="list-style-type: none"> ▶ Press [Mode/Enter] briefly. > The parameter is displayed again. The new setting value is stored. 	 <p>The diagram shows the device with '0000' on the display. An arrow points to the 'Mode/Enter' button. A second arrow points to the resulting display showing 'SP 1'.</p>
<p>Setting of other parameters:</p> <ul style="list-style-type: none"> ▶ Start again with step 1. 		
<p>Finishing the parameter setting:</p> <ul style="list-style-type: none"> ▶ Press [Mode/Enter] several times until the current measured value is displayed or wait for 15 s. > The unit returns to the operating mode. 		

- If [SLoc] is displayed when attempting a modification of a parameter value, the sensor is locked via software. This locking can only be removed via a parameter setting software.

- Change from menu level 1 to menu level 2:

<ul style="list-style-type: none"> ▶ Press [Mode/Enter] until [EF] is displayed. <p>If the submenu is protected with an access code, "Cod1" flashes in the display.</p> <ul style="list-style-type: none"> ▶ Press [Set] and keep it pressed until the valid code no. is displayed. ▶ Press [Mode/Enter] briefly. <p>On delivery by ifm electronic: no access restriction.</p>	
---	--

<ul style="list-style-type: none"> ▶ Press [Set] briefly. > The first parameter of the sub-menu is displayed (here: [Uni]). 	
--	--

UK

With the user interface of the ifm Container program:

- ▶ Activate the [EF] button.

If menu level 2 is protected by an access code, the input field for the code no. is activated.

- ▶ Enter valid code no.

- Locking / unlocking

The unit can be locked electronically to prevent unintentional settings.

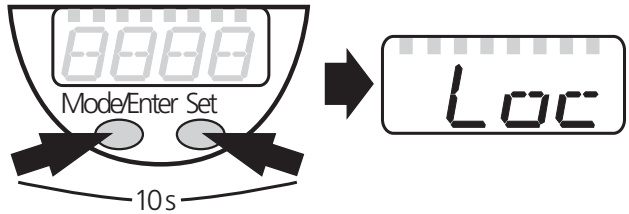
<ul style="list-style-type: none"> ▶ Make sure that the unit is in the normal operating mode. ▶ Press [Mode/Enter] + [Set] for 10 s. > [Loc] is displayed. 	
--	--

During operation: [Loc] is briefly displayed if you try to change parameter values.

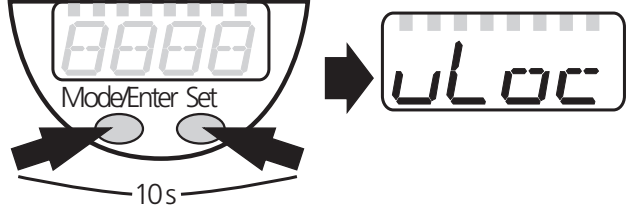

<p>For unlocking:</p> <ul style="list-style-type: none"> ▶ Press [Mode/Enter] + [Set] for 10 s. > [uLoc] is displayed. 	
---	--

On delivery: unlocked.

- Timeout:



If no button is pressed for 15 s during parameter setting, the unit returns to the operating mode with unchanged values.

9.2 Configuring the display (optional)



<p>▶ Select [Uni] and set the unit of measurement:</p> <ul style="list-style-type: none"> - [bar], [mbar], [MPa], [kPa], [PSI], for PE7009 in addition [inHg]. 	
<p>▶ Select [diS] and set update rate and orientation of the display:</p> <ul style="list-style-type: none"> - [d1]: Update of the measured value every 50 ms. - [d2]: Update of the measured value every 200 ms. - [d3]: Update of the measured value every 600 ms. - [rd1], [rd2], [rd3]: Display like d1, d2, d3; rotated by 180°. - [OFF]: The display is deactivated in the operating mode. 	

9.3 Setting the output signals

9.3.1 Setting of the output function

<p>▶ Select [OU1] and set the function:</p> <ul style="list-style-type: none"> - [Hno] = hysteresis function / normally open - [Hnc] = hysteresis function / normally closed, - [Fno] = window function / normally open, - [Fnc] = window function / normally closed 	
<p>▶ Select [OU2] and set the function:</p> <ul style="list-style-type: none"> - [Hno] = hysteresis function / normally open, - [Hnc] = hysteresis function / normally closed, - [Fno] = window function / normally open, - [Fnc] = window function / normally closed, - [dESI] = output 2 is used as a diagnostic output. 	

9.3.2 Setting of the switching limits

<p>▶ Select [SP1] / [SP2] and set the value at which the output switches.</p>	
<p>▶ Select [rP1] / [rP2] and set the value at which the output switches off. rPx is always smaller than SPx. The unit only accepts values which are lower than the value for SPx.</p>	

9.4 User settings (optional)

9.4.1 Setting of a time delay for the switching signals

<p>[dS1] / [dS2] = switch-on delay for OUT1 / OUT2. [dr1] / [dr2] = switch-off delay for OUT1 / OUT2.</p> <p>▶ Select [dS1], [dS2], [dr1] or [dr2] and set a value between 0.1 and 50 s (at 0.0 the delay time is not active).</p>	<p>dS1 dS2 dr1 dr2</p>
---	---------------------------------------

9.4.2 Setting of the output logic for the switching outputs

<p>▶ Select [P-n] and set [PnP] or [nPn].</p>	<p>P-n</p>
---	------------

9.4.3 Setting of the damping for the switching outputs

<p>▶ Select [dAP] and set a value. dAP value = response time between pressure change and change of the switching status in milliseconds. The following fix values can be set; they define the switching frequency (f) of the output:</p> <table border="1"> <tr> <td>dAP</td> <td>3</td> <td>6</td> <td>10</td> <td>17</td> <td>30</td> <td>60</td> <td>125</td> <td>250</td> <td>500</td> </tr> <tr> <td>f [Hz]</td> <td>170</td> <td>80</td> <td>50</td> <td>30</td> <td>16</td> <td>8</td> <td>4</td> <td>2</td> <td>1</td> </tr> </table>	dAP	3	6	10	17	30	60	125	250	500	f [Hz]	170	80	50	30	16	8	4	2	1	<p>dAP</p>
dAP	3	6	10	17	30	60	125	250	500												
f [Hz]	170	80	50	30	16	8	4	2	1												

9.5 Service functions

9.5.1 Reading the min./max. values for the system pressure

<p>▶ Select [HI] or [LO], press [Set] briefly. [HI] = maximum value, [LO] = minimum value. Delete memory:</p> <p>▶ Select [HI] or [LO]. ▶ Press [Set] until [----] is displayed. ▶ Press [Mode/Enter] briefly.</p> <p>[LO] is available only for PE7004 and PE7009.</p>	<p>HI LO</p>
---	-------------------

9.5.2 Reset all parameters to factory setting

<p>▶ Select [rES]. ▶ Press [Set] and keep it pressed until [----] is displayed. ▶ Press [Mode/Enter] briefly.</p> <p>It is recommended to take down your own settings in the table before carrying out a reset (→13 Factory setting).</p>	<p>rES</p>
---	------------

10 Operation

After power on, the unit is in the Run mode (= normal operating mode). It carries out its measurement and evaluation functions and provides output signals according to the set parameters.

Operating indications → chapter 7 Operating and display elements.

10.1 Reading of the set parameters

- ▶ Press [Mode/Enter] until the requested parameter is displayed.
- ▶ Press [Set] briefly.
- > The unit displays the corresponding parameter value for about 15 s. After another 15 s the unit returns to the Run mode.

10.2 Fault indication

[OL]	Overload pressure (measuring range exceeded)
[UL]	Underload pressure (below measuring range)
[SC1]	Short circuit in OUT1*
[SC2]	Short circuit in OUT2*
[SC]	Short circuit in both outputs*
[Err]	Flashing: internal fault

*The output concerned is switched off as long as the short circuit exists.

The messages SC1, SC2, SC, and Err are shown even if the display is switched off.

10.3 Setting ranges

		SP1 / SP2		rP1 / rP2		ΔP
		min	max	min	max	
PE7002	bar	1.0	100.0	0.5	99.5	0.5
	PSI	20	1450	10	1440	10
	MPa	0.10	10.00	0.05	9.95	0.05
PE7003	bar	0.2	25.0	0.1	24.9	0.1
	PSI	4	362	2	360	2
	MPa	0.02	2.50	0.01	2.49	0.01
PE7004	bar	-0.90	10.00	-0.95	9.95	0.05
	PSI	-12	145	-13	144	1
	MPa	-0.090	1.000	-0.095	0.995	0.005
PE7006	bar	0.02	2.50	0.01	2.49	0.01
	PSI	0.4	36.2	0.2	36.0	0.2
	kPa	2	250	1	249	1
PE7007	mbar	10	1000	5	995	5
	PSI	0.2	14.5	0.1	14.4	0.1
	kPa	1.0	100.0	0.5	99.5	0.5
	inHg	0.3	29.5	0.2	29.4	0.1
PE7009	mbar	-970	1000	-980	990	10
	PSI	-14.0	14.4	-14.2	14.2	0.2
	kPa	-97.0	100.0	-98.0	99.0	1.0
	inHg	-28.8	29.4	-29.1	29.1	0.3

ΔP = increments

UK

11 Factory setting

	Factory setting	User setting
SP1	25% VMR*	
rP1	23% VMR*	
OU1	Hno	
OU2	Hno	
SP2	75% VMR*	
rP2	73% VMR*	
dS1	0.0	
dr1	0.0	
dS2	0.0	
dr2	0.0	
P-n	PnP	
dAP	60	
diS	d2	
Uni	bAr / mbAr	

* = the indicated percentage of the final value of the measuring range (VMR) of the corresponding sensor in bar / mbar is set.