



Operating instructions
Pressure sensor

efectorsoo

PY929x

UK

11450573 / 00 08 / 2012

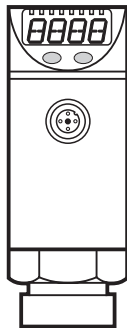

Contents

1	Preliminary note.....	3
1.1	Symbols used.....	3
2	Safety instructions.....	3
3	Functions and features.....	4
4	Function.....	4
4.1	Communication, parameter setting, evaluation.....	4
4.2	Switching function.....	5
4.3	Diagnostic function.....	5
5	Installation.....	6
6	Electrical connection.....	6
7	Operating and display elements.....	7
8	Menu.....	8
8.1	Menu structure.....	8
8.2	Explanation of the menu.....	9
9	Parameter setting.....	10
9.1	General parameter setting.....	10
9.2	Configure display (optional).....	12
9.3	Set output signals.....	12
9.3.1	Set the output function.....	12
9.3.2	Set switching limits.....	12
9.4	User settings (optional).....	13
9.4.1	Set delay for the switching outputs.....	13
9.4.2	Set switching logic for the switching outputs.....	13
9.4.3	Set the damping for the switching outputs.....	13
9.5	Service functions.....	13
9.5.1	Read min/max values for system pressure.....	13
9.5.2	Reset all parameters to factory setting.....	13
10	Operation.....	14
10.1	Read set parameters.....	14
10.2	Error indications.....	14
10.3	Setting ranges.....	15
11	Technical data and scale drawing.....	15
12	Factory setting.....	16

1 Preliminary note

1.1 Symbols used

- ▶ Instructions
- > Reaction, result
- [...] Designation of pushbuttons, buttons or indications
- Cross-reference



Important note

Non-compliance can result in malfunction or interference.

UK

2 Safety instructions

- Please read the product description prior to set-up of the unit. Ensure that the product is suitable for your application without any restrictions.
- If the operating instructions or the technical data are not adhered to, personal injury and/or damage to property can occur.
- Check the compatibility of the product materials (→ chapter 12 Technical data) with the media to be measured in all applications.
- Use in gases at pressures > 25 bar only on request.

3 Functions and features

The unit monitors the system pressure of machines and installations.

Applications

Type of pressure: relative pressure

Order no.	Measuring range		Permissible overload pressure		Bursting pressure	
	bar	PSI	bar	PSI	bar	PSI
PY9291	0...250	0...3625	400	5800	850	12300
PY9292	0...100	0...1450	300	4350	650	9400
PY9293	0...25	0...363	150	2175	350	5075
PY9294	-1...10	-14.5...145	75	1087	150	2175

$$\text{MPa} = \text{bar} \div 10 / \text{kPa} = \text{bar} \times 100$$



Avoid static and dynamic overpressure exceeding the given overload pressure by taking appropriate measures.

The indicated bursting pressure must not be exceeded.

Even if the bursting pressure is exceeded only for a short time, the unit may be destroyed. NOTE: risk of injury!

Use in gases at pressures > 25 bar only on request.

4 Function

4.1 Communication, parameter setting, evaluation

- The unit displays the current process value.
- It generates 2 output signals according to the parameter setting.

OUT1	• Switching signal for process value; IO-Link.
OUT2	2 options • Switching signal for process value. • Diagnostic signal (output 2 is inactive in case of a fault).

- The following functions are available via IO-Link (OUT1):
reading the current process value, changing the parameters and transferring them to other units of the same type using parameter setting tools with IO-Link capability (except the FDT service program ifm Container).

4.2 Switching function

OUTx changes its switching state if it is above or below the set switching limits (SPx, rPx). The following switching functions can be selected:

- Hysteresis function / normally open: [OUx] = [Hno] (→ fig. 1).
- Hysteresis function / normally closed: [OUx] = [Hnc] (→ fig. 1).

First the set point (SPx) is set, then the reset point (rPx) with the requested difference.

- Window function / normally open: [OUx] = [Fno] (→ fig. 2).
- Window function / normally closed: [OUx] = [Fnc] (→ fig. 2).

The width of the window can be set by means of the difference between SPx and rPx. SPx = upper value, rPx = lower value.

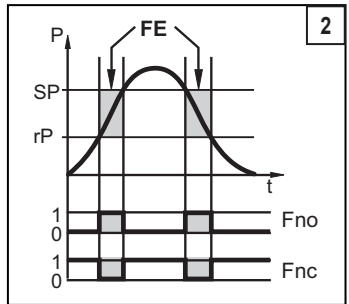
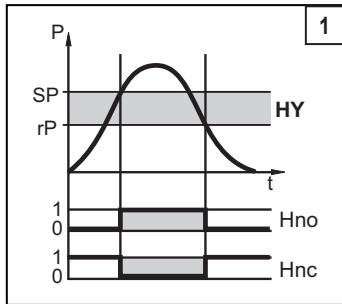

P = system pressure; HY = hysteresis; FE = window

4.3 Diagnostic function

Output 2 is used as diagnostic output based on the DESINA specification if [OU2] = [dESI].

- If there is no fault, the output is switched and carries UB+ (if P-n = PnP) or UB- (if P-n = nPn).
- In case of malfunctions the output becomes inactive. The following malfunctions are detected:
 - measuring cell defective
 - short circuit in output 1

5 Installation



Before installing and removing the unit: make sure that no pressure is applied to the system.

- ▶ Insert the unit in a G $\frac{1}{4}$ process connection.
- ▶ Tighten firmly.

6 Electrical connection



The unit must be connected by a qualified electrician.

The national and international regulations for the installation of electrical equipment must be adhered to.

Voltage supply to SELV, PELV.

- ▶ Disconnect power.
- ▶ Connect the unit as follows:

	2 x positive switching	2 x negative switching

Pin 1	Ub+
Pin 3	Ub-
Pin 4 (OUT1)	• Binary switching output; IO-Link
Pin 2 (OUT2)	• Binary switching output if [OU2] = [Hno], [Hnc], [Fno] or [Fnc] • Diagnostic output if [OU2] = [dESI]

Core colours of ifm sockets:

1 = BN (brown), 2 = WH (white), 3 = BU (blue), 4 = BK (black)

7 Operating and display elements

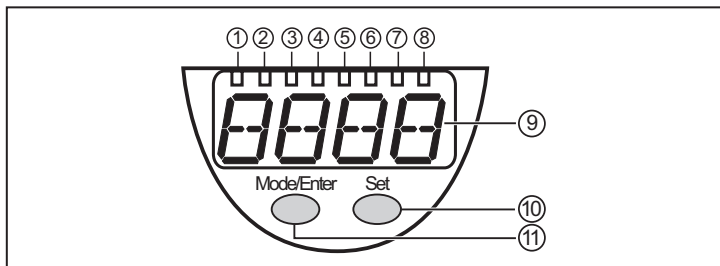

1 to 8: indicator LEDs

- LED 1 to LED 3 = system pressure in the unit of measurement which is indicated on the label.
- LEDs 4, 5 and 6: not used.
- LED 7, LED 8 = switching state of the corresponding output.

9: Alphanumeric display, 4 digits

- Display of the current system pressure.
- Indication of the parameters and parameter values.

10: Set button

- Setting of the parameter values (scrolling by holding pressed; incrementally by pressing once).

11: Mode/Enter button

- Selection of the parameters and acknowledgement of the parameter values.

8 Menu

8.1 Menu structure

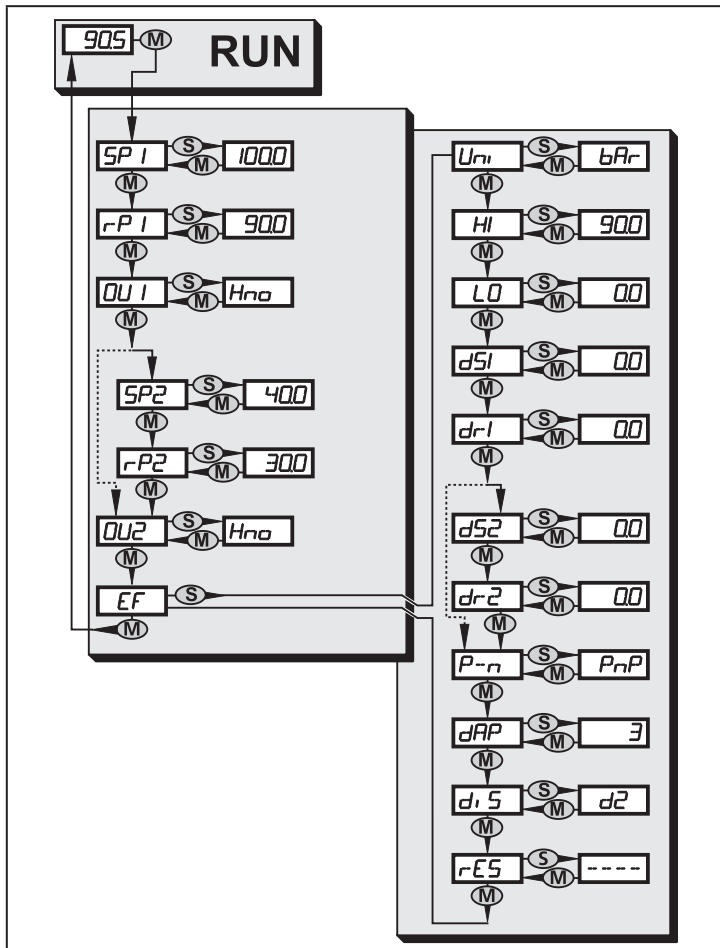

8.2 Explanation of the menu

SP1/rP1	Upper / lower limit value for system pressure at which OUT1 switches.
SP2/rP2	Upper / lower limit value for system pressure at which OUT2 switches.
OU1	Output function for OUT1: <ul style="list-style-type: none">• Switching signal for the pressure limit values: hysteresis function [H ..] or window function [F ..], either normally open [. no] or normally closed [. nc].
OU2	Output function for OUT2: <ul style="list-style-type: none">• Switching signal for the pressure limit values: hysteresis function [H ..] or window function [F ..], either normally open [. no] or normally closed [. nc].• Diagnostic signal [OU2] = dESI
EF	Extended functions / opening of menu level 2.
Uni	Standard unit of measurement for system pressure.
HI	Maximum value memory for system pressure.
LO	Minimum value memory for system pressure (only PY9294).
dS1/dS2	Switch-on delay for OUT1 / OUT2.
dr1/dr2	Switch-off delay for OUT1 / OUT2.
P-n	Output logic: pnp / npn.
dAP	Damping for the switching outputs.
diS	Update rate and orientation of the display.
rES	Restore factory settings.



UK

9 Parameter setting

During parameter setting the unit remains in the operating mode. It continues its monitoring functions with the existing parameters until the parameter setting has been completed.

9.1 General parameter setting

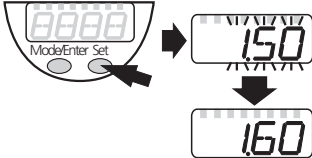
3 steps must be taken for each parameter setting:

1 Select parameter ▶ [Press [Mode/Enter] until the requested parameter is displayed.	
2 Set parameter value ▶ Press [Set] and keep it pressed. > Current setting value of the parameter flashes for 5 s. > After 5 s: setting value is changed: incrementally by pressing once or scrolling by holding pressed.	
Numerical values are incremented continuously. For reducing the value: let the display move to the maximum setting value. Then the cycle starts again at the minimum setting value.	
3 Acknowledge parameter value ▶ Press [Mode/Enter] briefly. > The parameter is displayed again. The new setting value is stored.	
Set other parameters ▶ Start again with step 1.	
Finish parameter setting ▶ Press [Mode/Enter] several times until the current measured value is displayed or wait for 15 s. > The unit returns to the operating mode.	

- If [SLoc] is displayed when attempting a modification of a parameter value, the sensor is locked via software. This locking can only be removed via a parameter setting software.

- Change from menu level 1 to menu level 2:

<ul style="list-style-type: none"> Press [Mode/Enter] until [EF] is displayed. <p>If the submenu is protected with an access code, [Cod1] flashes in the display.</p> <ul style="list-style-type: none"> Press [Set] and keep it pressed until the valid code no. is displayed. Press [Mode/Enter] briefly. <p>When delivered by ifm electronic: no access restriction.</p>	
--	---

<ul style="list-style-type: none"> Press [Set] briefly. <p>> The first parameter of the submenu is displayed (here: [Uni]).</p>	
---	---

With the user interface of the program ifm Container:

- Activate the [EF] button.
If menu level 2 is protected by an access code, the input field for the code no. is activated.
- Enter the valid code no.

- Locking / unlocking

The unit can be locked electronically to prevent unintentional settings.

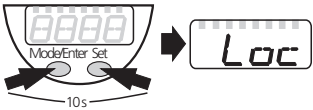
<ul style="list-style-type: none"> Make sure that the unit is in the normal operating mode. Press [Mode/Enter] + [Set] for 10 s. <p>> [Loc] is displayed.</p>	
--	---

During operation: [LOC] is briefly displayed if you try to change parameter values.

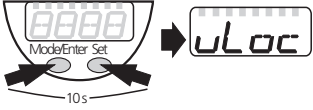
<p>For unlocking:</p> <ul style="list-style-type: none"> Press [Mode/Enter] + [Set] for 10 s. <p>> [uLoc] is displayed.</p>	
---	---

Factory setting: unlocked.

- Timeout:

If no button is pressed for 15 s during parameter setting, the unit returns to the operating mode with unchanged values.

9.2 Configure display (optional)

<ul style="list-style-type: none"> ▶ Select [Uni] and set the unit of measurement: <ul style="list-style-type: none"> - [bar], [MPa], [PSI]. 	<i>Uni</i>
<ul style="list-style-type: none"> ▶ Select [diS] and set the update rate and orientation of the display: <ul style="list-style-type: none"> - [d1]: update of the measured values every 50 ms. - [d2]: update of the measured values every 200 ms. - [d3]: update of the measured values every 600 ms. - [rd1], [rd2], [rd3]: display as for d1, d2, d3; rotated by 180°. - [OFF]: The display is switched off in the operating mode. 	<i>d, 5</i>

9.3 Set output signals

9.3.1 Set the output function

<ul style="list-style-type: none"> ▶ Select [OU1] and set the function: <ul style="list-style-type: none"> - [Hno] = hysteresis function/NO, - [Hnc] = hysteresis function/NC, - [Fno] = window function/NO. - [Fnc] = window function/NC. 	<i>OU 1</i>
<ul style="list-style-type: none"> ▶ Select [OU2] and set the function: <ul style="list-style-type: none"> - [Hno] = hysteresis function/NO, - [Hnc] = hysteresis function/NC, - [Fno] = window function/NO. - [Fnc] = window function/NC, - [dES1] = output 2 is used as a diagnostic output. 	<i>OU2</i>

9.3.2 Set switching limits

<ul style="list-style-type: none"> ▶ Select [SP1] / [SP2] and set the value at which the output switches. 	<i>SP 1</i> <i>SP2</i>
<ul style="list-style-type: none"> ▶ Select [rP1] / [rP2] and set the value at which the output switches back. rPx is always smaller than SPx. The unit only accepts values which are lower than the value for SPx. 	<i>rP 1</i> <i>rP2</i>

9.4 User settings (optional)

9.4.1 Set delay for the switching outputs

[dS1] / [dS2] = switch-on delay for OUT1 / OUT2.

[dr1] / [dr2] = switch-off delay for OUT1 / OUT2.

- ▶ Select [dS1], [dS2], [dr1] or [dr2] and set a value between 0.1 and 50 s (at 0.0 the delay time is not active).

dS1
dS2
dr1
dr2

9.4.2 Set switching logic for the switching outputs

- ▶ Select [P-n] and set [PnP] or [nPn].

P-n

9.4.3 Set the damping for the switching outputs

- ▶ Select [dAP] and set the value.

dAP value = response time between pressure change and change of the switching status in milliseconds.

The following fixed values can be set; they define the switching frequency (f) of the output:

dAP	3	6	10	17	30	60	125	250	500
f [Hz]	170	80	50	30	16	8	4	2	1

dAP

9.5 Service functions

9.5.1 Read min/max values for system pressure

- ▶ Select [HI] or [Lo], briefly press [Set].

[HI] = maximum value, [LO] = minimum value.

Delete memory:

- ▶ Select [HI] or [LO].
 - ▶ Press [SET] and keep it pressed until [----] is displayed.
 - ▶ Press [Mode/Enter] briefly.
- [LO] is only available for PY9294.

HI
LO

9.5.2 Reset all parameters to factory setting

- ▶ Select [rES].
- ▶ Press [SET] and keep it pressed until [----] is displayed.
- ▶ Press [Mode/Enter] briefly.

It is recommended to take down your own settings in the table before carrying out the function (→ 11 Factory setting).

rES

UK

10 Operation

After power on, the unit is in the Run mode (= normal operating mode). It carries out its measurement and evaluation functions and provides output signals according to the set parameters.

Operation indication → chapter 7 Operating and display elements.

10.1 Read set parameters

- ▶ Press [Mode/Enter] until the requested parameter is displayed.
- ▶ Press [Set] briefly.
- > The unit displays the corresponding parameter value for approx. 15 s. After another 15 s it returns to the Run mode.

10.2 Error indications

[OL]	Overload pressure (above measuring range).
[UL]	Underload pressure (below measuring range).
[SC1]	Short circuit in OUT1*.
[SC2]	Short circuit in OUT2*.
[SC]	Short circuit in both outputs*.
[Err]	Flashing: internal fault

*The output concerned is switched off as long as the short circuit exists.
The messages SC1, SC2, SC, Err are shown even if the display is switched off.

10.3 Setting ranges

		SP1 / SP2		rP1 / rP2		ΔP
		min	max	min	max	
PY9291	bar	2	250	1	249	1
	PSI	40	3620	20	3600	20
	MPa	0.2	25.0	0.1	24.9	0.1
PY9292	bar	1.0	100.0	0.5	99.5	0.5
	PSI	20	1450	10	1440	10
	MPa	0.10	10.00	0.05	9.95	0.05
PY9293	bar	0.2	25.0	0.1	24.9	0.1
	PSI	4	362	2	360	2
	MPa	0.02	2.50	0.01	2.49	0.01
PY9294	bar	-0.90	10.00	-0.95	9.95	0.05
	PSI	-12	145	-13	144	1
	MPa	-0.090	1.000	-0.095	0.995	0.005

ΔP = step increment

11 Technical data and scale drawing



The technical data and the scale drawing of the current unit version can be found in the data sheet of the respective unit at www.ifm.com → search function (enter the order number).

12 Factory setting

	Factory setting	User setting
SP1	25 % VMR*	
rP1	23 % VMR*	
OU1	Hno	
OU2	dESI	
SP2	75 % VMR*	
rP2	73 % VMR*	
dS1	0.0	
dr1	0.0	
dS2	0.0	
dr2	0.0	
P-n	PnP	
dAP	60	
diS	d2	
Uni	bAr	

* = The indicated percentage of the final value of the measuring range (VMR) of the corresponding sensor is set in bar.