

User Manual of **GaugerGSM** and **Gauger485**



You Can Measure the Solid Benefits...

Notices and safety guidelines

This manual is a detailed technical guide for **GaugerGSM**, **GaugerGPS** and **Gauger485** level sensors. Some information in this manual refers to **Gauger420** and cannot be applied to other Gauger models.

The manual is published under the following conditions and restrictions:

- Some features are firmware, hardware, model or version dependent. These features are described in the user manual but will not apply to all Gauger sensors. In case of doubt, the user should verify which features apply.
- Information included in this manual is subject to change without notice. Information in the manual may contain inaccuracies. Specifications are based on laboratory test results which are performed under tightly controlled environment. Field performance may vary from laboratory test results. We always welcome suggestions and recommendations from the users of our manuals.
- Gauger sensors must be installed, connected and operated in accordance with the instructions of this manual and with certification requirements as applicable. Specific local regulations may also apply.
- Installation and use of Gauger models that are rated for use in explosive atmosphere must closely follow the instructions detailed in the proper section for this model type.
- Do not open or disassemble Gauger sensors except as required for electrical connections.
- Any type of modifications and repairs are permissible only upon the manufacturer or re-seller written approval and by pre-qualified personal. Never reuse defective parts.
- The manual contains proprietary information belonging to Solid Applied Technologies Ltd. The information is published solely for the purpose of assisting authorized users of Gauger level sensors.
- No part of this manual may be used for any other purpose, or disclosed to any person or firm, or reproduced by any means, without the prior written permission of Solid Applied Technologies Ltd.
- The text and graphics in this manual are for the purpose of illustration and reference only.
- All company names, brand products and service names that may appear in this manual are trademarks or registered trademarks of their respective holders.
- Solid Applied Technologies shall not be liable for loss or damage caused by the use of this manual or of products described in the manual. Solid Applied Technologies sole warranty is that products sold by the company shall be free of defects in material and in workmanship for a period of 12 months.

Date	Revision	Software version	Part number
May 2014	4.4	GaugerGSM/485 V 2.8	GaugerGSM/485

Table of Contents

NOTICES AND SAFETY GUIDELINES.....	2
TABLE OF CONTENTS.....	3
LIST OF FIGURES.....	7
I. INTRODUCTION	8
I.1. DESCRIPTION	8
I.2. GAUGERGSM/485 PARTS	9
I.3. DIMENSIONS	10
I.4. SPECIFICATIONS.....	11
I.5 HOW TO USE THIS USER MANUAL.....	14
<i>I.5.1 Looking for specific tasks.....</i>	<i>14</i>
<i>I.5.2 Proposed study guide.....</i>	<i>14</i>
II. PHYSICAL AND ELECTRICAL INSTALLATION GUIDELINES.....	15
II.1. GEOMETRICAL CONSIDERATIONS.....	15
II.2. TANK FITTING	17
II.3. DEAD ZONE	17
II.4. EXTENSION PIPE	18
II.5. TEMPERATURE CONSIDERATIONS AND TEMPERATURE SENSORS - GAUGERGSM	19
II.6. ELECTRICAL CONNECTIONS.....	20
II.7. BATTERY OPERATION AND PTS.....	21
II.8. SIM CARD FOR GAUGERGSM.....	22
II.9. SPECIAL INSTRUCTION FOR EX-RATED MODELS	24
<i>II.9.1 EX rating and general conditions for use</i>	<i>24</i>
<i>II.9.2 EX wiring restrictions.....</i>	<i>24</i>
<i>II.9.3 EX electrical powering schemes</i>	<i>25</i>
<i>II.9.4 Special instructions for the use of an EX-rated PTS and battery pack.....</i>	<i>27</i>
<i>II.9.5 Repair and maintenance for EX-rated Gauger, PTS and battery pack</i>	<i>28</i>
II.10. TEST MODE DURING INSTALLATION	29
II.11. MUST BE PAMPHLET	30
III. KEYPAD AND DISPLAY	31
III.1. KEYPAD	31
<i>III.1.1 Navigation keys.....</i>	<i>31</i>
<i>III.1.2 Execution keys.....</i>	<i>31</i>
III.2. NAVIGATION THROUGH MENUS.....	32
<i>III.2.1 Sub-Menu style.....</i>	<i>32</i>
<i>III.2.2 Numeric menu style</i>	<i>32</i>
III.3. MEASUREMENT SCREEN.....	33
<i>III.3.1 Status reports.....</i>	<i>34</i>
<i>III.3.2 Contrast.....</i>	<i>34</i>
<i>III.3.3 Main menu / setup.....</i>	<i>34</i>

III.3.4 Temperature readings.....	34
III.3.5 Ultrasonic echo conditions.....	34
III.3.6 Product identification details	35
IV. CONFIGURATION WITH THE KEYPAD AND DISPLAY	36
IV.1. MENU AND SUB-MENU ORGANIZATION	36
IV.2. QUICK SETUP	37
IV.3. ADVANCED SETTINGS	38
V. CONFIGURATION WITH A PC OR OVER-THE-AIR	39
V.1. INTRODUCTION	39
V.2. PREPARING A CONFIGURATION TEXT FILE	39
V.2.1 Sample files.....	39
V.2.2 Configuration text file - summary notes	41
V.3. DOWNLOAD OPERATION	41
V.3.1 Procedure.....	41
V.3.2 Launching and setting up HyperTerminal	42
V.3.3 Downloading a configuration file	44
V.4. RESPONSES FROM GAUGERGSM/485.....	45
V.4.1 Good response	45
V.4.2 Erroneous responses	45
V.4.3 Communication Errors	47
V.5. LIST OF COMMANDS FOR CONFIGURATION FROM A PC.....	48
V.5.1 Conventions	48
V.5.2 Command list	50
V.6 USEFUL EXAMPLES.....	57
V.6.1 Basic setup	57
V.6.2 Advanced setup.....	57
For an example on using LPST and DLOG see Reference Chapter IX section: Logger Operation.	58
V.6.3 GPRS setup example	58
V.6.4 OCF – Flow Mapping Table example (American Units).....	58
V.7 CONFIGURATION OVER-THE-AIR (OTA) BY SMS	59
V.8 CONFIGURATION OVER RS485.....	60
VI. FIRMWARE UPGRADE TOOL	61
VI.1. INTRODUCTION	61
VI.2. YOU WILL NEED.....	61
VI.3. INSTALLATION OF FIRMWARE UPGRADE TOOL AND USB DRIVER	61
VI.4. UPGRADE PROCEDURE.....	62
VI.5. TROUBLESHOOTING THE FIRMWARE UPGRADE PROCESS	64
VII. SERIAL DATA MONITORING	65
VIII. USB DRIVER INSTALLATION ON A PC	66
IX. REFERENCE GUIDE	69
A	70
APPLICATION DIMENSIONS AND CONSTRAINTS.....	71

(a) Basic dimensions.....	71
(b) Distance to empty level	72
(c) Distance to full level.....	72
(d) Far blocking distance	72
(e) Near blocking distance.....	73
APPLICATION TYPE.....	73
C	74
CELLULAR COMMUNICATION (GAUGERGSM ONLY)	75
CONTACT ALERT (GAUGERGSM ONLY).....	75
CORRECTION FOR TIME OF DAY (GAUGERGSM/485 ONLY).....	75
D	76
DEFAULT VALUES.....	77
DESTINATION PHONE NUMBER (GAUGERGSM ONLY).....	78
DISTANCE UNITS AND VALUE TO DISPLAY	78
E.....	79
EQUIPMENT STATUS REPORT (GAUGERGSM ONLY)	80
F.....	81
FALSE ECHO SCAN BY PC.....	82
FILLING RATE.....	82
FULL AND EMPTY ALERTS (GAUGERGSM ONLY)	82
G	83
GAS VELOCITY COEFFICIENT	84
GAUGERBUS (GAUGERGSM/485 ONLY).....	84
GPRS ARCHITECTURE (GAUGERGSM ONLY)	85
GPRS MESSAGE FORMAT (GAUGERGSM ONLY)	86
GSM DISPLAY STATUS REPORTS (GAUGERGSM ONLY)	88
GSM REPORTING INTERVAL (GAUGERGSM ONLY)	89
H	90
HART COMMUNICATIONS (GAUGER420 WITH HART OPTION ONLY)	91
I.....	92
INTERDEPENDENCIES.....	93
L.....	94
LOGGER OPERATION (GAUGERGSM ONLY).....	95
M	97
MAPPING TABLE	98
O	99
OPEN CHANNEL FLOW	100
P.....	103
PTS CONFIGURATION FOR BATTERY OPERATION (GAUGERGSM ONLY)	104
R	106
REFILL ALERTS (GAUGERGSM/485 ONLY)	107
RELAY DEVICE.....	107
RELAY TRUTH TABLE (GAUGERGSM/485 ONLY)	108
RESET AND OPERATING HOURS.....	109
S.....	110
SMS FORMAT (GAUGERGSM ONLY)	111

T.....	112
TEMPERATURE COEFFICIENT OF EXPANSION	113
TEMPERATURE SENSORS, UNITS AND TEMPERATURE DISPLAY.....	113
TEST MODE DURING INSTALLATION (GAUGERGSM/485 ONLY).....	114
THEFT ALERTS (GAUGERGSM/485 ONLY)	114
TRIGGER ALERTS (GAUGERGSM/485 ONLY).....	115
V	117
VOLUME MEASUREMENT	118
(a) <i>General</i>	118
(b) <i>Box shaped</i>	118
0-9	120
4-20 COMMUNICATIONS – APPLICABLE TO GAUGER420 ONLY	121
(a) <i>4-20 Setup</i>	121
(b) <i>4-20 Performance</i>	122
(c) <i>4-20 constraints</i>	122
(d) <i>4-20 default settings</i>	123
X. TROUBLESHOOTING.....	125

List of Figures

Figure 1 – GaugerGSM/485 parts	9
Figure 2 – GaugerGSM/485 dimensions (75 KHz version)	10
Figure 3 – Minimum horizontal gap.....	15
Figure 4 - Silo (left) and liquid (right) examples.....	16
Figure 5 - Threaded flange (left) Thread-free flange (right)	17
Figure 6 – Possible extension pipe settings	18
Figure 7 – Possible extension pipe fittings – 75 KHz example	19
Figure 8 - Electrical ports	20
Figure 9 - Programmable Timer Switch Connections	22
Figure 10 - SIM Card.....	23
Figure 11 - Electrical feeding scheme within hazardous zone (battery pack)	25
Figure 12 - Electrical feeding scheme when crossing zones (battery pack)	26
Figure 13 - Electrical feeding scheme for external power supply.....	27
Figure 14 - Navigation keys.....	31
Figure 15 - Execution keys	31
Figure 16 - Sub menu screens.....	32
Figure 17 - Numeric menu	33
Figure 18 - Measurement screen.....	33
Figure 19 - Temperature readings	34
Figure 20 - Menu and submenu organization.....	36
Figure 21 - Application dimensions for sensor 75KHz	71
Figure 22 - GPRS communication architecture.....	85
Figure 23 - Side view of Sharp crest (left) and broad crest (right).....	100
Figure 24 - Trapezoidal sharp crested weir.....	101
Figure 25 - Front view of Palmar Bowlus flume.....	101
Figure 26 - Low power predefined levels.....	104
Figure 27 - Temperature readings	113
Figure 28 - Trigger definition in percentage	115
Figure 29 - Box shaped tank.....	118
Figure 30 - Cylindrical horizontal tank	119
Figure 31 - Cylindrical vertical tank.....	119
Figure 32 - Default 4-20 values for Level	123
Figure 33 - Default 4-20 values for Volume	123
Figure 34 - Default 4-20 values for Distance.....	124

I. Introduction

I.1. Description

GaugerGSM/485 is a non-contact ultrasonic level sensor with integrated GSM cellular modem (GaugerGSM only) and USB interface. Optional items include display, external temperature sensor, dry contact input and relay.

GaugerGSM/485 measures distance. Targets may be liquid or solids. Measurement is continuous and does not require contact with the target. The system can accurately measure steady or agitated target surfaces. The system can also rapidly track filling and emptying of vessels. **GaugerGSM/485** (75 KHz) measures distance to liquid targets up to 8 meters and **GaugerGSM/485** (50 KHz) up to 9.5 meters. In addition to distance, **GaugerGSM/485** also measures temperature of the environment.

GaugerGSM/485 makes use of the measured distance to calculate additional process variables. These variables include target level, volume and flow in open channels (OCF).

GaugerGSM/485 operates at an ultrasonic frequency of 75KHZ or 50 KHz and is robust in noisy conditions. The sensor is made of PVDF – providing good chemical resistance to corrosive targets. The enclosure is sealed to IP68. **GaugerGSM/485** is fed from 8-33VDC power. The system may be fed by an external battery pack. A low power mode is available for using batteries and requires the use of a Programmable Timer Switch (PTS).

GaugerGSM/485 is equipped with a large graphic display and keypad allowing a simple wizard-driven setup of the system. The keypad and display allow configuration of many **GaugerGSM/485** configuration parameters. Complete setup of all **GaugerGSM/485** parameters can be executed using a USB equipped PC or laptop. This method of configuration supports rapid cloning of many **GaugerGSM/485** systems.

GaugerGSM transmits measurement information to a predefined destination. Two options are available: GPRS data to a web based monitoring center or SMS to one destination. Reporting interval is user-programmable. The system also identifies and transmits an alert in events such as full and empty situations. The system can be programmed to identify and alert for rapid changes of level indicating theft and refuel quantities. The system can also transmit On/Off contact state information.

Gauger485 sends the measured data over RS485 wires or over a USB interface (to a PC). The protocol is character-based.

This user manual is intended for operators of **GaugerGSM/485**. The manual covers system description, installation, operation and troubleshooting of **GaugerGSM/485**.

1.2. GaugerGSM/485 parts

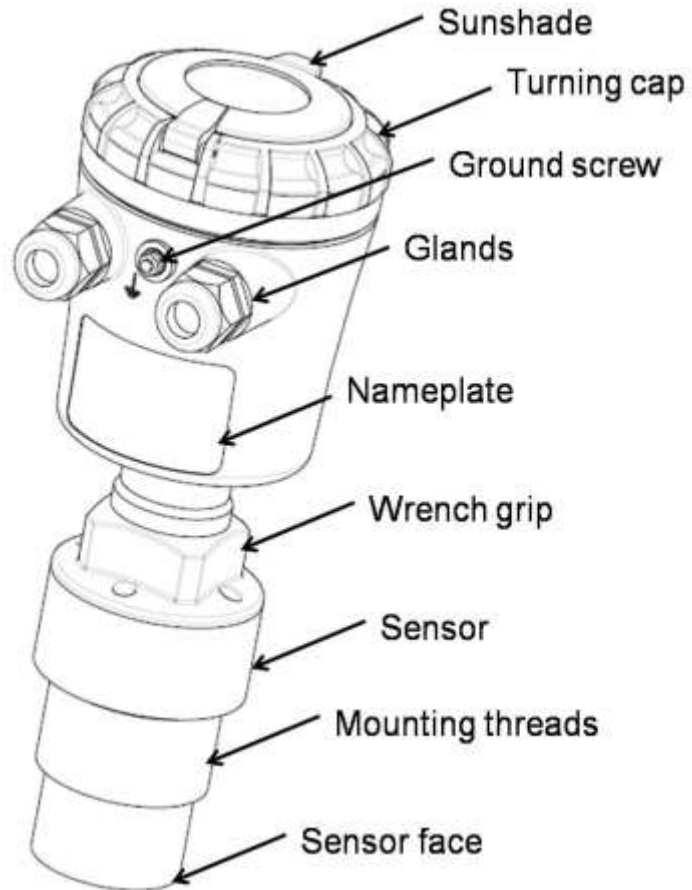

Figure 1 – GaugerGSM/485 parts

1.3. Dimensions

All figures in mm.

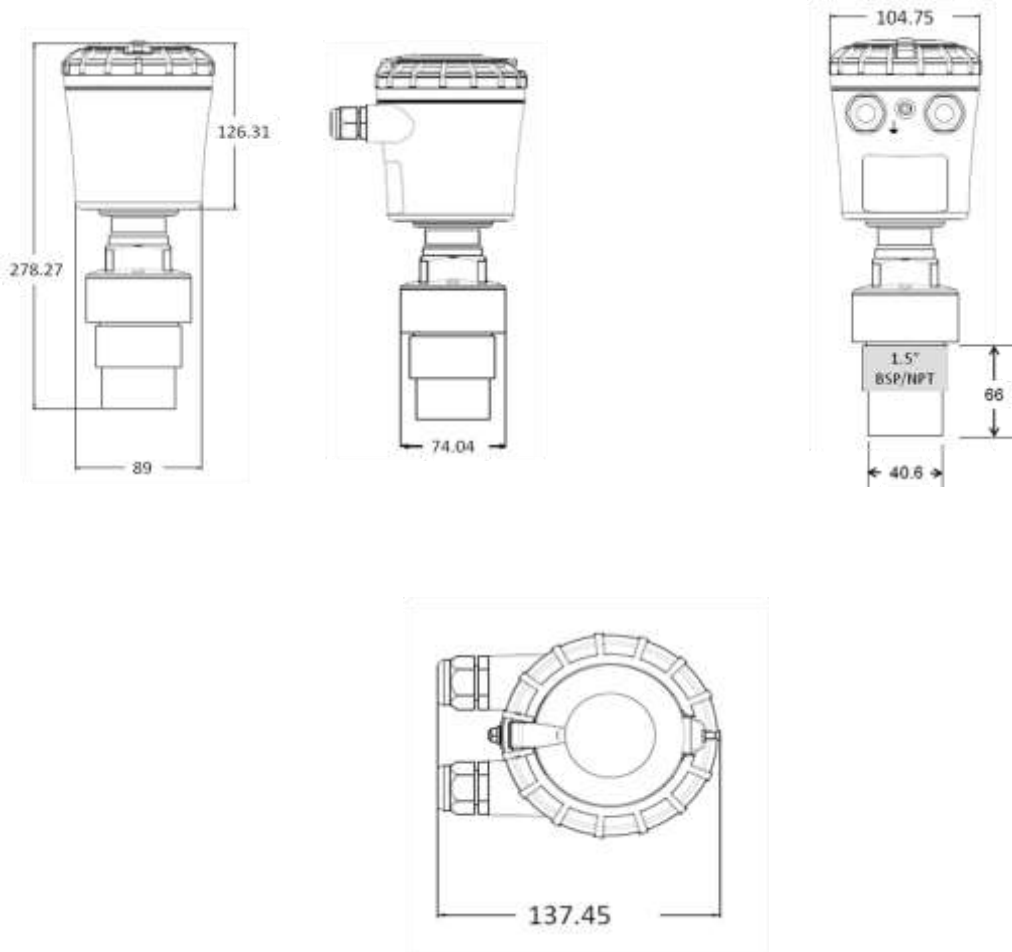

Figure 2 – GaugerGSM/485 dimensions (75 KHz version)

1.4. Specifications

Measuring range (75 KHz version)

Maximum range for liquids	-	8 meter / 26'
Maximum range for Solids	-	5 meter / 16'
		Approximate, depending on type of solid
Minimum range (dead zone)	-	15 cm / 6"

Measuring range (50 KHz version)

Maximum range for liquids	-	9.5 meter / 30'
Maximum range for Solids	-	6 meter / 19'
		Approximate, depending on type of solid
Minimum range (dead zone)	-	35 cm / 14"

Accuracy – precision – resolution –tracking (75 KHz version)

Display Accuracy

15cm<Range<60cm	-	1.5mm
60cm<Range<5m	-	0.3% of measured range
5m<Range<8m	-	0.2% of maximum range
Display Precision (repeatability)	-	0.2% of measured range
Display resolution	-	1 mm
SMS/GPRS resolution (GaugerGSM)	-	1 mm
Process tracking rate	-	10 meter per minute maximum

Accuracy – precision – resolution –tracking (50 KHz version)

Display Accuracy

35cm<Range<60cm	-	1.5mm
60cm<Range<5m	-	0.3% of measured range
5m<Range<9.5m	-	0.25% of maximum range
Display Precision (repeatability)	-	0.3% of measured range
Display resolution	-	1 mm
SMS/GPRS resolution (GaugerGSM)	-	1 mm
Process tracking rate	-	10 meter per minute maximum

Electrical specifications

Power supply	-	8 to 33 VDC on GaugerGSM/485 ports
Low power mode	-	Programmable sleep mode profile
Current consumption at 24VDC		
Continuous	-	Less than 10mA
For GaugerGSM only:		

During cellular transmission	-	Less than 40mA
Spikes at switch / transmission	-	Less than 160mA
Data interface	-	Serial COM over USB at 115,200bps
USB port supporting (device side)	-	Firmware upgrade Configuration Local monitoring
Display	-	64X128 Graphic LCD, viewing size 50X25mm ²
Relay rating	-	1A / 60VDC
Ultrasonic frequency	-	75 KHz or 50 KHz
GaugerGSM Cellular modem specifications:		
Band	-	Quad band 850/900/1800/1900 MHz
Output power	-	Class 4 (33dBm) for EGSM850/EGSM900 Class 1 (30dBm) for GSM1800/GSM1900
SMS	-	Point-to-point MO and MT
GPRS	-	Multi-slot class 10 Coding schemes 1-4
Reports		
Displayed	-	Level and percentage level Distance and percentage distance Volume and percentage volume Flow (open channel) and percentage Temperature (internal and external) Echo strength Global and resettable operating hours Ultrasonic and cellular status reports
For GaugerGSM only:		
Data sent by SMS/GPRS	-	Level, Distance, Volume, Temperature, Status
Alerts sent by SMS / GPRS	-	Full, Empty, over consumption, refill, Contact On/Off, pre-configured levels
System Configuration options	-	Local keypad / display or PC via USB port
Temperature characteristics		
Operational temperature range	-	-20°C to +70°C -30°C to +70°C for models without display
Temperature sensors	-	Two: internal and external
Temperature compensation	-	Built-in based on internal sensor. External sensor or averaged of two for GaugerGSM.

Temperature display	-	Internal and external temperature Instantaneous and recorded high/low
Pressure	-	0.5 bar to 5 bar (correct measurement verified at 2 meter range).
Mechanical specifications		
Enclosure material	-	Plastic PC/ABS+UV
Sensor material	-	PVDF
Sealing rating	-	IP65/IP67
	-	IP68 - 96 hours at 1.8 meter depth in water
Mounting threads	-	1.5" BSP or 1.5" NPT (for 75 KHz version) 2.0" BSP or 2.0" NPT (for 50 KHz version)
Cable entries	-	Conduit ½" NPT
Weight	-	960 gram
Certifications	-	CE: EMC and Safety FCC Part 15 FCC-ID: QIPMC55I (Cinterion modem MC55i) EX-rating ATEX and IECEx (optional): II 1G, Ex ia IIB T4 Ga, Ta = -30°C to +70°C Ex-rating for battery pack and PTS (optional): II 2G, Ex ib IIB T3 (162°C) Gb, Ta = -30°C to +70°C

1.5 How to use this user manual

1.5.1 Looking for specific tasks...

At this stage...	Do this...
First thing	Read the description section in the introduction chapter. Review notices and safety guidelines.
If you are not familiar with Level measurement terms	Review the section: Application dimensions and constraints in the reference guide chapter.
If you are ready to power up the Gauger	Review the sections: electrical schematics and electrical connections in the physical and electrical installation chapter.
If you want to quickly configure the Gauger	Study the chapter: keypad and display. Then read the section about quick setup in the chapter that follows.
If you want to know <u>all</u> about Gauger configurations	Study the chapter: configuration with a PC while referring to the reference guide chapter as required.
If you are about to install in the field	Study chapter: Physical and electrical installation guidelines. If you are using an EX-rated model carefully read and then implement the special instructions related to EX-rated models.
If you are unsure about any term or concept	Consult with the reference guide chapter. The chapter is arranged alphabetically and you can quickly find all terms in the Table of Contents.

1.5.2 Proposed study guide

	Study Division	Lessons	UM chapters
1	Parts & specifications	1.1 Parts 1.2 Specifications 1.3 Basic measurement concepts	I.2, I.3 I.4 IX. Application
2	Electrical connections, simple measurements & SMS transmissions	2.1 Connecting power supply 2.2 Measuring distance 2.3 Measuring level 2.4 Transmitting SMS to cellular phone	II.6 III, IV.2 IV.2 IV.3
3	Setup by PC and simple measurements	3.1 USB connection of PC to GaugerGSM 3.2 USB setup commands 3.3 Measuring volume 3.4 Wired monitoring	VIII V V.5.2,V.5.3 VII
4	Advanced operations	4.1 Open channel flow 4.2 GPRS 4.3 PTS and battery pack 4.4 Alert events 4.5Firmware upgrade tool	V.5.2 V.5.2, IX.GPRS II.7, V.5.2 V.5.2 VI
5	Monitoring software	5.1 Log & Forward (L&F) 5.2 Site Monitoring Center (SMC)	User Manual of L&F User Manual of SMC

II. Physical and electrical installation guidelines

This chapter is a list of guidelines for proper physical installation of **GaugerGSM/485** on tanks including electrical connections. Always ensure that **GaugerGSM/485** is installed in an area that meets the stated ratings of the product including temperature and technical specifications. If you are using an EX-rated GaugerGSM model, read also the special instructions sections related to EX-rated models. The final section is a short and concise list of instructions – the “must-be pamphlet”.

II.1. Geometrical considerations

- Gauger systems are installed above the target (e.g. water, fuel) being measured and should not make contact with the target at any time. Typically, the systems are installed on top of a tank (filled with liquid) through a hole on the roof of the tank. In outdoor applications, **GaugerGSM/485** may be attached to a metal arm extending above the target. The arm may be attached to a nearby post.
- **GaugerGSM/485** should be located as far as possible from vertical tank walls and from other physical obstructions such as filling inlets. Keep a minimum gap of: 30 cm plus 10 cm for each meter of measurement range.

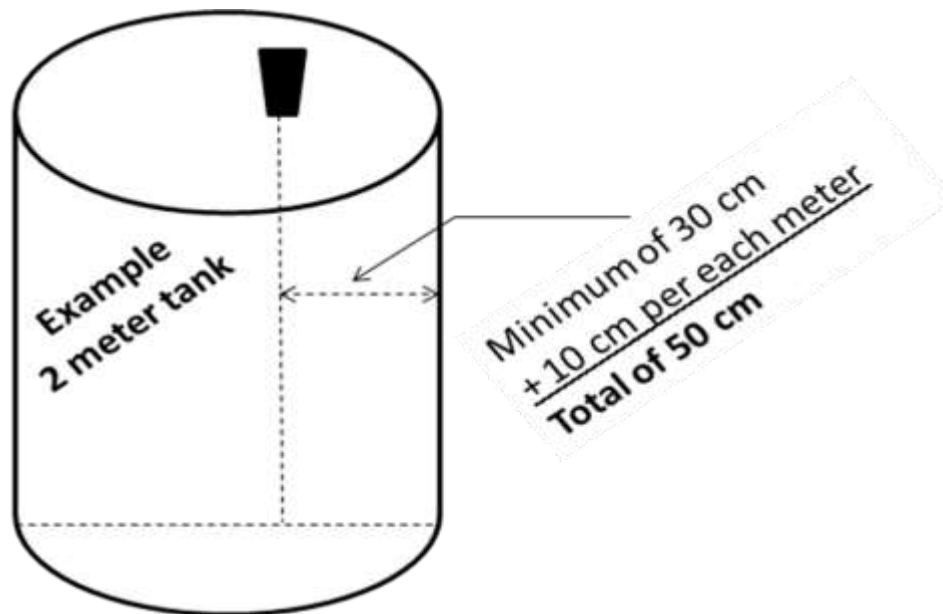

Figure 3 – Minimum horizontal gap

- For best results, place **GaugerGSM/485** away from sources of acoustic noise or sources of vibrations.

- **GaugerGSM/485** should be perpendicular to the surface of a liquid target. The angular displacement should be less than 5° from the vertical axis.
- For solids in silos, **GaugerGSM/485** should be aimed towards the center of the silo's base. The sensor should be displaced from the center of the tank and oriented perpendicular to the solids surface when tank is at full state.



Figure 4 - Silo (left) and liquid (right) examples

- Proper physical installation is accompanied by software setup. Setup includes defining parameters such as tank height and may include additional parameters such as NBD, FBD, False echo scan and more. For additional information read the section in the reference guide: “Application dimensions and constraints”.

II.2. Tank fitting

GaugerGSM is equipped with a 1.5" BSP/NPT (75 KHz) or 2.0" BSP/NPT (50 KHz) or thread allowing two fitting options: direct fitting in a threaded flange or fastened with a BSP/NPT nut through a thread-free flange.

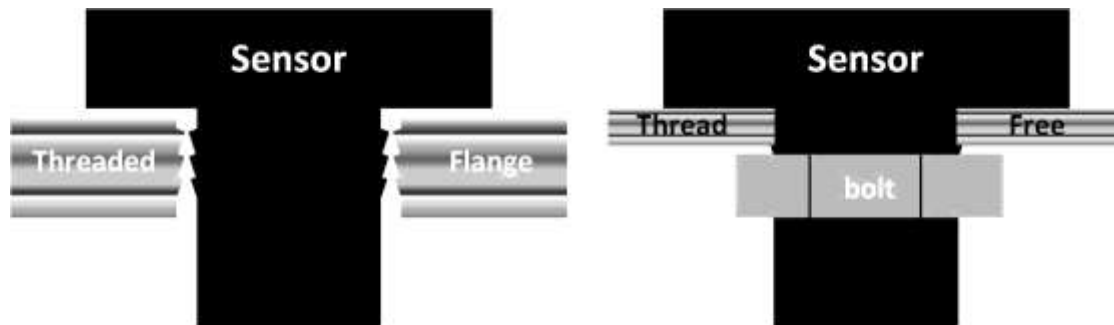

Figure 5 - Threaded flange (left) Thread-free flange (right)

For outdoor installations, use a stable arm. Firmly attach the sensor to the arm using a through-hole and threaded nut. Alternatively, attach the sensor to a threaded hole which is built-in the arm.

Always verify thread compatibility between **GaugerGSM/485** and flange or nut. Do not use excessive force when using threads. Preferably, tighten by hand only. If you do use a wrench, grip **GaugerGSM/485** at the wrench grip surfaces only (see figure **GaugerGSM/485** parts) and exert light force.

II.3. Dead zone

See reference guide: "Application dimensions and constraints".

A gap must be kept between the face of sensor and the topmost level of the target. This gap must be at least the size of the specified "dead zone". If the target level passes the dead zone, measurements may be unpredictable. Therefore, it is recommended to keep a margin gap between the expected topmost level and the dead zone border. Where the topmost level is too close to the tank roof, an extension pipe is required for the installation as described below.

II.4. Extension pipe

See reference guide: “Application dimensions and constraints”.

An extension pipe is required for installations where the topmost target level is too close to the roof of the tank. In such cases, an extension pipe is installed on the tank and the sensor is installed on top of the extension pipe at a safe distance from the topmost level of the target. The lower border of the dead zone may fall inside the tank as seen in the right hand side of the figure below. In this case no further software settings are required.

The lower border of the dead zone may also fall within the extension pipe as described in the left hand side of the figure below. In such cases, the Near Blocking Distance (NBD) should be configured in the software. In some cases, pipes add false echoes at distance longer than the pipe length. In those cases PIPE configuration command should be implemented.

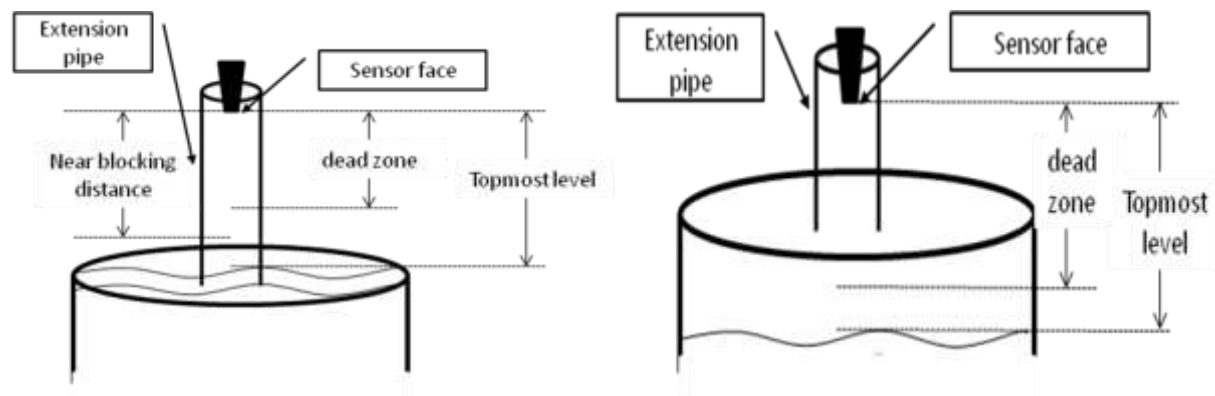

Figure 6 – Possible extension pipe settings

A typical structure of an extension pipe is shown on the next figure. Closely follow these guidelines when using an extension pipe:

- Internal pipe diameter should be at least 3” wide
- The diameter of the hole on the flange or tank should not be smaller than the pipe diameter
- Pipe length (measured from sensor face) should be no longer than 50 cm
- The pipe should not protrude into the tank
- Pipe should be exactly perpendicular to the surface of the target
- Sensor must be located at the center of the pipe

- Pipe should have a smooth interior surface
- The hole in the flange or tank should have a smooth edge and welding spots must be avoided
- Preferably, the pipe should be made of plastic

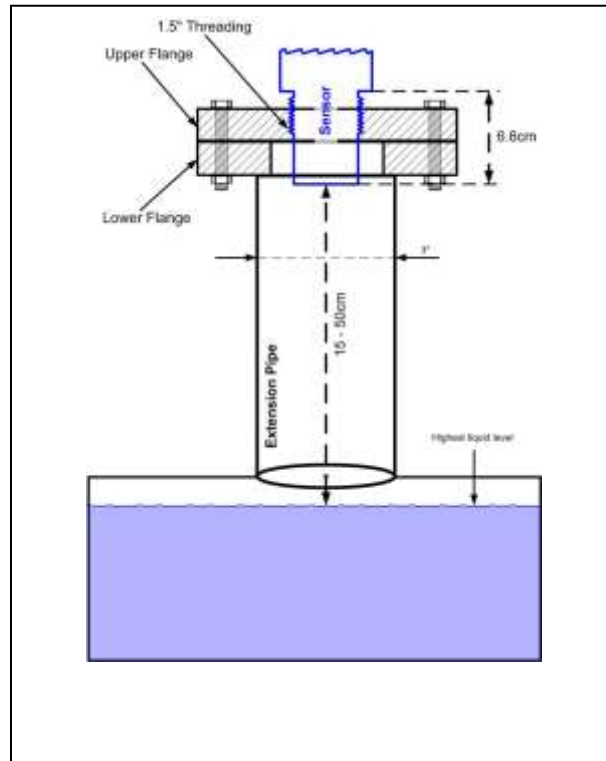

Figure 7 – Possible extension pipe fittings – 75 KHz example

II.5. Temperature considerations and temperature sensors - GaugerGSM

See also reference guide: “Temperature sensors, units and display”.

When using an external temperature sensor, place the sensor at a location that best represents temperature of the air between the sensor face and the target. Connect the sensor internally as described in the electrical connection section to the Thermistor pins. External temperature sensors may be ordered from the manufacturer or reseller or may be purchased independently. Use Thermistor NTC 10K Ohm 5% (minimum) P/N 2381-640-63103 by Vishay BC Components or equivalent.

When using the internal temperature sensor, avoid situations where the **GaugerGSM** is exposed to different thermal conditions than its environment. Avoid direct sunlight on the Gauger. Direct sunlight may overheat the system and cause measurement inaccuracies, measurement variations in time and even failure of the system in extreme cases. If GaugerGSM is exposed to direct sunlight, construct a local sunshade (“umbrella”) over the Gauger and an external temperature sensor is recommended.

In areas of large temperature variations, take into consideration volume changes of the target due to temperature expansion. Temperature coefficient of expansion may be as high as 1000ppm/1°C.

II.6. Electrical connections

Carefully follow these steps when connecting power supply to GaugerGSM/485. Power supply must fulfill the proper rating requirements as defined in the specifications chapter above. This chapter is supplemented by an on-line video clip. Search for “YouTube GaugerGSM”.

II.6.1 Turn off GaugerGSM/485.

II.6.2 Turn the GaugerGSM/485 top cap anti-clockwise and expose the electrical connections board. Identify the elements as shown in the following figure. SIM card refers to GaugerGSM only.

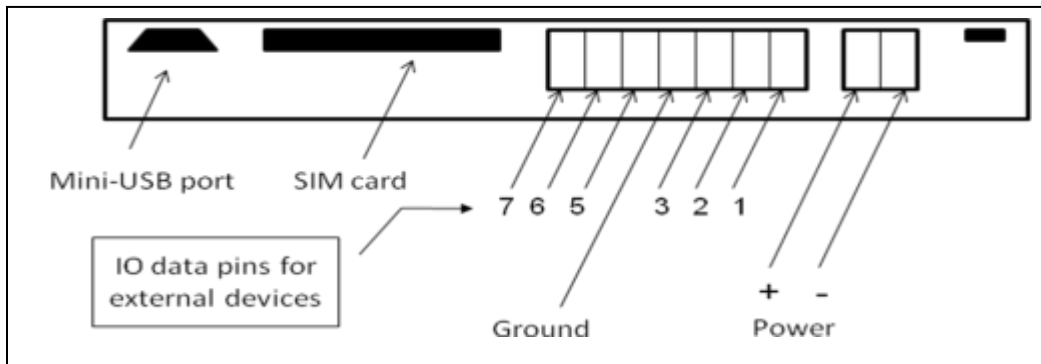

Figure 8 - Electrical ports

II.6.3 Insert the power cables into the **GaugerGSM/485** through one of the glands. Ensure that high voltage sources or cables are at least 1 meter away from **GaugerGSM/485** and cables. Keep the electrical supply lines away from electromagnetic interference sources. When inserting a cable through the gland, use round cables with minimum diameter of 6 mm to ensure that the unit remains sealed to IP67. Use silicon paste to ensure sealing. Connector terminals may be pulled up for easy wire connection and then re-inserted back again.

II.6.4 Connect the power cables to the appropriate terminals. Note that **GaugerGSM/485** operates from a DC power supply of 8-33 VDC. Always make sure that sufficient voltage is present on the **GaugerGSM/485** power terminals, irrespective of any voltage drop along the supply lines. When using a power supply that comes as an accessory of **GaugerGSM/485**, the brown color is Plus (+) and the yellow (or yellow with green stripes) is the Minus (-).

II.6.5. When using an external temperature sensor, the thermistor should be connected to data pins 5 and 4 [GND] (in previous model versions: pins 6 and 7).

II.6.6. When using an external Programmable Timer Switch (PTS) or RS485, the wires should be connected to pins 6 and 7.

II.6.7 When using an input contact alert, connect short/open between pins 3 and 4 (ground). See the section about contact alerts in the reference guide chapter (not applicable to EX models).

II.6.8 The mini-USB port is a USB device-side supporting virtual COM ports. The port may be used for firmware upgrades, field monitoring and remote setup. Details about firmware upgrade are provided in the chapter: Firmware upgrade. USB is supported in EX models but is not allowed for use when installed in explosive areas.

II.6.9 Summary of Data Pins

Pin #	Non EX Models	EX Models	Previous models	Comments
1	Relay A	Relay A	Relay A	Relay A operation defined by USB command RLY.
2	Relay COM	Relay COM	Relay COM	
3	Input contact	Relay B	Relay B	Relay B is complementary to relay A. GND is second pin for Input Contact.
4	GND	GND	GND	Data pins COM
5	Thermistor	Thermistor	Input contact	GND is second pin
6	RS485-A	RS485-A	RS485-A / Thermistor	
7	RS485-B	RS485-B	RS485-B / Thermistor	

II.6.10 Limitations to the use of RS485

In some configurations, RS485 is applied for internal application and cannot be deployed by the user. This applies to a configuration where PTS is deployed and the Gauger controls the PTS through the RS485 interface. This also applies to GaugerGPS where the GPS receiver is connected to the Gauger through the RS485 interface (the GPS protocol is GPGLL at 4800 bps interface and one message per 3 seconds).

II.7. Battery operation and PTS

GaugerGSM supports low power mode for extended external battery lifetime. This mode of operation requires the external Programmable Timer Switch (PTS) to be connected between GaugerGSM and battery.

PTS connections:

- First connect the 5-wire cable from the PTS to GaugerGSM/485 through one of the glands.
 - ✓ Connect the Brown (+) wire to the power plus (+) on GaugerGSM/485

- ✓ Connect the Yellow (-) wire to the power minus (-) on GaugerGSM/485
 - ✓ Connect the White wire to pin 6 on the electrical port panel (see figure above)
 - ✓ Connect the Green wire to pin 7 on the electrical port panel
 - ✓ Connect the Blue (Ground) wire to the Ground port on GaugerGSM/485
- Then connect the 3-wire cable from the PTS to the battery
 - ✓ Connect the Brown (+) wire to the battery plus (+)
 - ✓ Connect the Yellow (-) wire to the battery minus (-)
 - ✓ Connect the Blue wire to a local ground at or nearby the battery

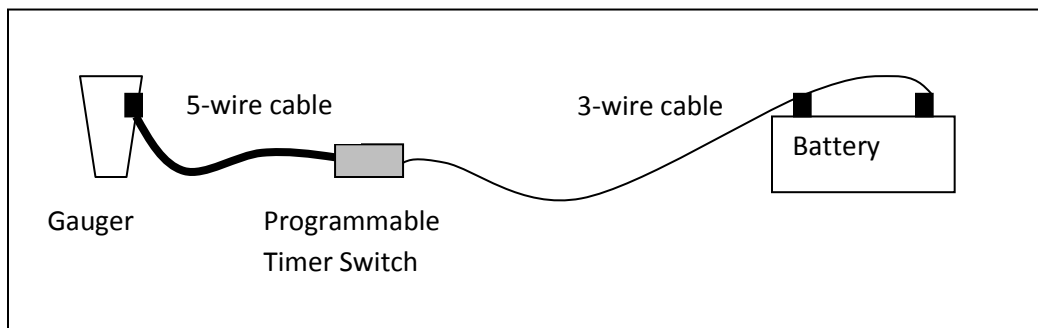

Figure 9 - Programmable Timer Switch Connections

When using an EX-rated model, please also read and implement the special instructions for EX-rated models. PTS software configuration is described in the reference guide.

II.8. SIM card for GaugerGSM

A SIM card must be inserted in the **GaugerGSM** to allow use of the cellular feature. Never insert or take out a SIM card when GaugerGSM power is on. Follow these instructions regarding your SIM card:

II.8.1 The SIM Card must support SMS / GPRS services with your local cellular operator. You do not need any voice or browser capabilities in your cellular service. Depending on your cellular operator – you might be required to use a USIM card.

II.8.2 Deactivate the SIM PIN code if the PIN code is active. Deactivation is performed by inserting the SIM card into a cellular phone and following the instructions of the phone manufacturer. PIN code configuration is usually found in your phone Settings – Security Settings – PIN Code Request or similar.

II.8.3 Always test your SIM card before inserting into **GaugerGSM**. Test the SIM card by inserting the card into a cellular phone and sending an SMS or browsing over GPRS. Verify that no PIN code is required, that the proper operator serves the cellular link and that the SMS / GPRS browsing operate correctly.

II.8.4 Turn off **GaugerGSM**. Turn the **GaugerGSM** top cap anti-clockwise and expose the electrical connections board. Insert the SIM card into the proper slot as described in the following figure. The SIM may be pulled out by pressing it downward again.

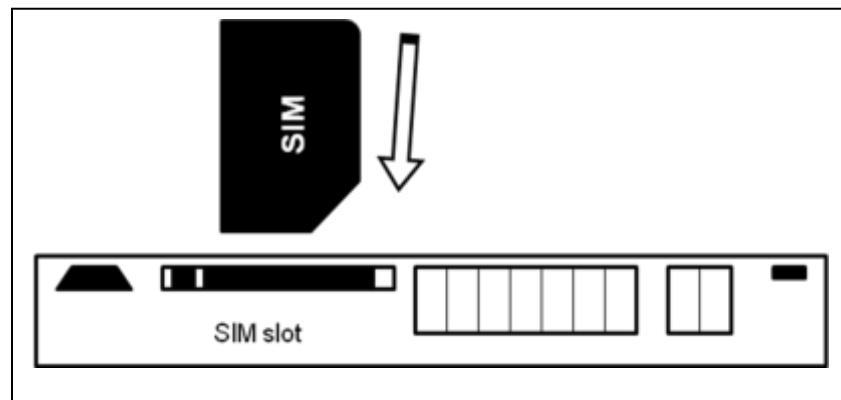

Figure 10 - SIM Card

II.8.5 Aim **GaugerGSM** to proper target (e.g. floor), turn on **GaugerGSM** and closely observe the lower status line on the display (status lines are explained in the operating instructions chapter - measurement screen sub-chapter).

You should observe the report “GSM / GPRS initializing” for 30-60 seconds. Then you should observe several additional status reports to the effect that an SMS or GPRS message is sent. This indicates proper SIM card operation (for additional information review the section “GSM display status reports” in the reference guide chapter).

Warning: Depending on firmware version, if SIM card is not inserted in GaugerGSM, GaugerGSM may reset periodically every two minutes or so. This is proper operation of the Gauger in response to its inability to send cellular messages.

II.9. Special instruction for EX-rated models

II.9.1 EX rating and general conditions for use

GaugerGSM/485 EX-rated models may be installed and used in explosive atmospheres as covered by certifications IECEx SIR 10.0113X and SIRA 10ATEX2237X. The rating is Ex II 1G, Ex ia IIB T4 Ga with Ta = -30°C to +70°C. The equipment adheres to intrinsic safety “ia” as defined in IEC 60079-11. The equipment may be used in hazardous locations only as marked and under the following conditions:

- In the presence of flammable gasses and vapors that do not exceed flammability of group IIA (e.g. Propane) and Group IIB (e.g. Ethylene)
- At a surface temperature which is limited to class T4 with maximum surface temperature of 135°C.
- In locations fit for Equipment Protection level EPL Ga including zones 0, 1 and 2.
- At ambient temperatures ranging between -30°C and +70°C. The equipment should not be used outside this temperature range.

II.9.2 EX wiring restrictions

- The equipment is to be installed by suitably trained personnel in accordance with the applicable code of practice (typically IEC/EN 60079-14).
- Setting up the Gauger Systems via USB should be performed outside the hazardous location.
- Use only interface accessories certified for this equipment. If in doubt, check with Solid Applied Technologies.
- For installations with an external thermistor (option dependent), use the thermistor provided by Solid Applied Technologies. Connect green and white wires between DI1 and Com interfaces. Do not allow incoming voltages.
- For installations with RS485 communication (option dependent), connect wire 'A' (inverting line) to DI2 and wire 'B' to DI3 interfaces (non-inverting line). Incoming voltage should not exceed 5.88V. Input power should not exceed 1.2W. RS485 wiring requires an external barrier.
- For installations with digital inputs (option dependent), connect the positive lines between each one of DI1, DI2 and DI3 interfaces to Com interface. Incoming voltage should not exceed 5.88V.

- For installations with relay digital outputs, connect the wires between NC, NO and Com interfaces. Incoming voltage should not exceed 30V.
- For installation with an external GSM antenna (option dependent – GaugerGSM only), use the Antenna provided by Solid Applied Technologies.
- Under certain extreme circumstances, the non-metallic parts incorporated in the enclosure of this equipment may generate an ignition-capable level of electrostatic charge. Therefore the equipment shall not be installed in a location where the external conditions are conducive to the build-up of electrostatic charge on such surfaces. The equipment is not isolated from the screen of the cables and the installer shall take this into account during installation

II.9.3 EX electrical powering schemes

Electrical powering schemes for EX-rated models must be one of the following certified methods.

II.9.3.1 Battery pack based feeding

With this option the equipment may reside in zone 1 or zone 2.

For systems fed by a battery pack, use a certified battery enclosure by Solid Applied Technologies equipped Tadiran Batteries TL-5930. Use Solid Applied Technologies certified PTS device in between the battery pack and the equipment. Use the following feeding scheme when the system is completely surrounded within the hazardous zone.

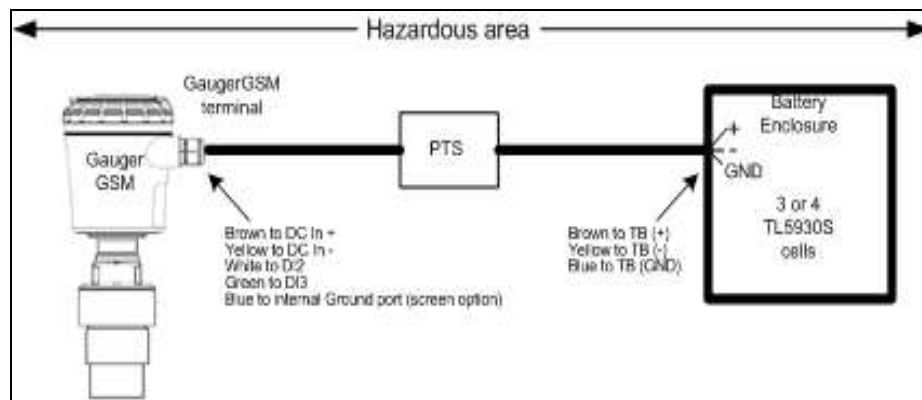

Figure 11 - Electrical feeding scheme within hazardous zone (battery pack)

When the PTS and GaugerGSM/485 are within the hazardous zone and the battery pack is in the non-hazardous zone use the following connectivity diagram:

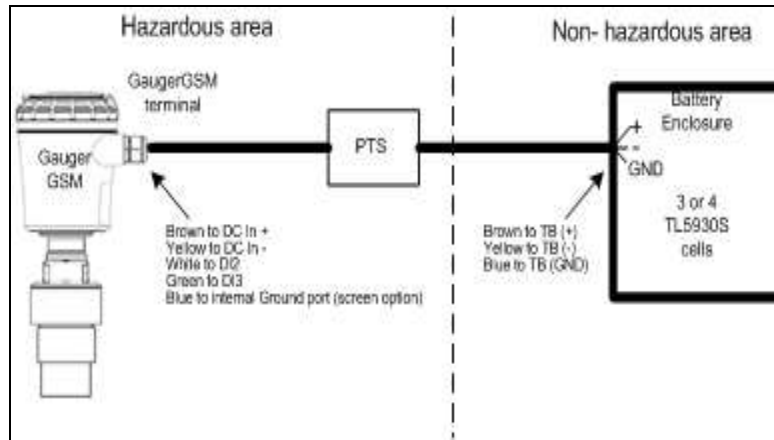

Figure 12 - Electrical feeding scheme when crossing zones (battery pack)

Note: In the feeding scheme as defined right above, the system meets the requirements for T4.

II.9.3.2 External power supply with barriers

With this option, the equipment may reside in zones 0, 1 or 2.

For systems fed by an external power supply, use a certified power/current barrier. Certified barriers are Stahl or MTL types as listed below or compatible with ATEX, FM, CANCELEC, CSA or UL safety approval that complies with the following limitations:

- | |
|---|
| <ul style="list-style-type: none"> ✓ U_i = 28V ✓ I_i = 170mA ✓ P_i = 1.212W ✓ C_i = 1nF ✓ L_i = 0 |
|---|

Install the barriers in accordance with the instructions provided by their manufacturers. Use the barrier feeding scheme when electrical cables cross zones.

Table of certified barriers

Barrier Manufacturer and Part Number		Nominal Power Supply [V]	Operating Temperature Range [°C]	Safety Parameters			Interconnection		For GSM message types
				U _o [V]	R _{min} [Ω]	I _{max} [mA]	Barrier Terminal	GaugerGSM Terminal	
Stahl	9001/01-280-280-101	24	-20 to +50	28	111	100(*)	3 4	DC In + DC IN – (**)	SMS or GPRS
Stahl	9001/01-199-390-101	16	-20 to +60	19.9	57	100(*)	3 4	DC In + DC IN – (**)	SMS only
MTL	7729P+	24	-20 to +60	28	167	170	3 4	DC In + DC IN – (**)	SMS only

(*) With current limit

(**) The polarity in the GaugerGSM/485 side is insignificant

Connectivity diagram with external power supply and barrier:

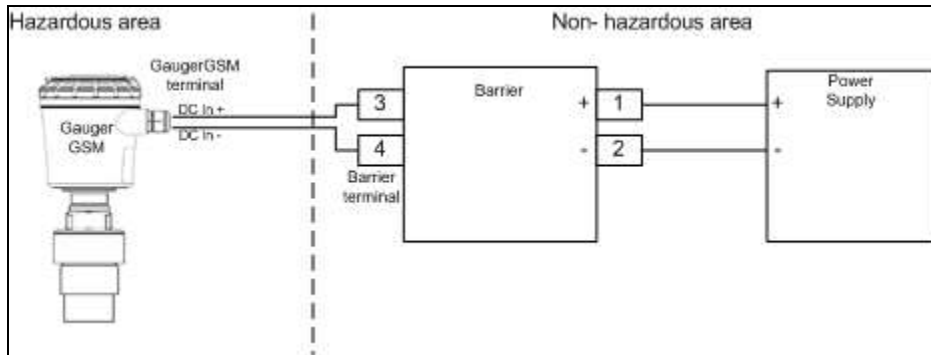

Figure 13 - Electrical feeding scheme for external power supply

II.9.3.3 Electrical noise filtering

Electrical noise filtering may be achieved by grounding the earth screw on the Gauger.

II.9.4 Special instructions for the use of an EX-rated PTS and battery pack

The following instructions apply to the Battery pack and PTS covered by certificate numbers IECEx SIR 10.0112X and SIRA 10ATEX2236X. Rating of items is II 2G Ex ib IIB T3 (162°C) Gb, Ta=-30°C to +70°C.

- This equipment may be used in zones 1 and 2 with flammable gases. Use only a complete set of new Tadiran TL-5930 cells which are rated individually as intrinsically safe. Certified battery packs are for 3 or 4 cells.
- The equipment is to be installed by suitably trained personnel in accordance with the applicable code of practice (typically IEC/EN 60079-14). Regular periodic inspection of the equipment should be performed by suitably trained personnel in accordance with the applicable code of practice to ensure it is maintained in a satisfactory condition. With respect to explosion safety, it is not necessary to check for correct operation and no user adjustment is required.
- Subject to the applicable code of practice, the battery enclosure may be temporarily opened and the internal cells replaced whilst the equipment is in the hazardous area. The cells may be transported in a hazardous area provided reasonable precautions are taken to prevent damage to the cells. The equipment contains no other user-replaceable parts.
- The equipment may be used in the presence of flammable gases and vapors with apparatus groups IIB or IIA and with temperature classes T1 or T2 or T3 or T4.
- The equipment is certified for use in ambient temperatures in the range of -30°C to $+70^{\circ}\text{C}$ and should not be used outside this range.
- Under certain extreme circumstances, the non-metallic parts incorporated in the enclosure of this equipment may generate an ignition-capable level of electrostatic charge. Therefore the equipment shall not be installed in a location where the external conditions are conducive to the build-up of electrostatic charge on such surfaces. The equipment is not isolated from the screen of the cables and the installer shall take this into account during installation. Additionally the equipment shall only be cleaned with a damp cloth.

II.9.5 Repair and maintenance for EX-rated Gauger, PTS and battery pack

- The equipment is not intended to be repaired by the user. Repair of this equipment shall only be carried out by the manufacturer, Solid Applied Technologies Ltd, or by a service company holding a dated authorization letter signed by the manufacturer for this equipment type and in accordance with the applicable code of practice. Contact info@solidaAT.com for additional information regarding the repair of this product.
- Regular periodic inspection of the equipment should be performed by suitably trained personnel in accordance with the applicable code of practice.
- The inspector must ensure that the equipment, related accessories and cables are all physically intact. Any observed damage to the equipment or accessories or cables including any exposed wiring should be considered as fatal and prevent further use until repaired or replaced.

- If the equipment is likely to come into contact with aggressive substances, e.g. solvents that may affect polymeric materials, than it is the responsibility of the user to take suitable precautions that prevent the equipment from being adversely affected and to ensure that the type of protection is not compromised. Unscheduled inspections should be performed whenever such events are suspected.
- The equipment shall only be cleaned with a damp cloth. No regular user adjustment or calibration is required for this equipment and its accessories.

II.10. Test Mode during installation

See Reference Guide chapter, section: Test Mode during installation.

II.11. MUST BE Pamphlet

Consider copying and taking this page to the field with you.

1) Choosing location

Distance to tank walls	MUST BE	at least 30cm from walls + 10cm/1m range
Flange	MUST BE	fixed on a horizontal surface
Acoustic noises	MUST BE	far away from acoustic noises and vibrations
Electrical interference	MUST BE	shielded away from power and sensor cables
Tank installation	MUST BE	far away from tank inlets, outlets, physical obstacles
Sensor	MUST BE	exactly perpendicular to the surface of the target
External thermistor	MUST BE	in shaded location, attached to the tank body

2) Handling dead zone

Extension pipes (1)	MUST BE	of at least 3" internal diameter and 15/25 cm above target (from sensor face)
Extension pipes (2)	MUST BE	with completely smooth interior surface
Extension pipes (3)	MUST BE	installed with a flange/not protruding into the tank

3) Power source

Voltage	MUST BE	at least 8VDC on unit terminals
Battery (internal/external)	MUST BE	rated higher than 8VDC due to voltage drop
Ripple and noise	MUST BE	not exceeding 100mV
Type	MUST BE	preferably regulated switching power supply
USB power source	MUST BE	accompanied by power source for field operations

4) Cellular communications

SIM card & SMS/GPRS service	MUST BE	Inserted in the SIM card slot
Destination phone number	MUST BE	Set and formatted correctly
SMS / GPRS alerts	MUST BE	Defined using correct limits

5) Measurement Configuration

Full/Empty, Level/Distance	MUST BE	configured correctly
Filling rate	MUST BE	defined (consider the application)
False echo scan	MUST BE	executed when the tank is empty
Near blocking distance (NBD)	MUST BE	set up in flange and extension pipe installations

6) EX-rated models	MUST BE	Installed & used in accordance with special instructions.
---------------------------	----------------	---

III. Keypad and display

This chapter describes the keypad and display of **GaugerGSM/485**. The keypad and display add the following functionality to **GaugerGSM/485**:

- Viewing measurement results and viewing information related to the system
- Configuring **GaugerGSM/485**

Some models of **GaugerGSM/485** are provided without a display/keypad. In these models configuration of the system is performed with a PC. This chapter focuses on the structure and operation of the keypad and display. Configuration of the system is described in following chapters. Expose the keypad by turning the cap counterclockwise all the way.

III.1. Keypad

III.1.1 Navigation keys

Use the navigation keys to scroll through the display.

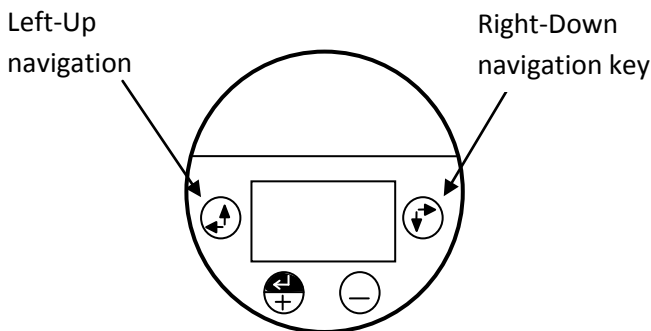

Figure 14 - Navigation keys

III.1.2 Execution keys

Use the execution keys to change a digit or to execute a command (**Back**, **Next** or **Sub-menu**):

To change a digit: navigate to the digit and press the Plus (+) key or the Minus (-) key.

To execute a command: navigate to the command and press the Enter (+) key.

Remember – some changes are saved only after returning to the measurement screen. If you shut down **GaugerGSM/485** before you return to the measurement screen, your changes may be lost.

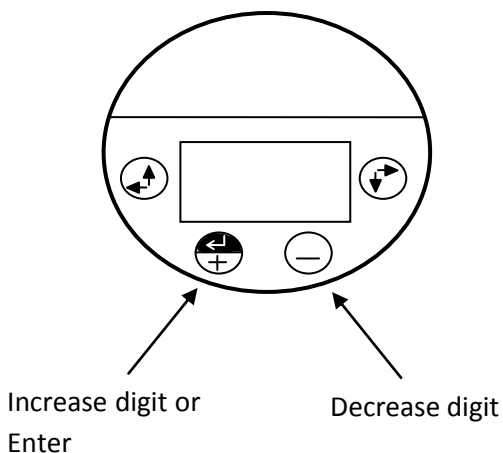

Figure 15 - Execution keys

III.2. Navigation through menus

GaugerGSM/485 supports two menu styles which are used throughout the setup operations and are described below. False echo scan employs a third menu style and is described at the relevant section below.

III.2.1 Sub-Menu style

The Sub-Menu style presents a list of vertical choices. An arrow may appear on the right hand side of the screen if additional items can be reached when scrolling down. The scrolling is cyclic, meaning that when you reach the last (first) item, the next step will lead you to the first (last) item. Scroll up or down, using the navigation keys, to your selected choice and press Enter (+). This action will lead you to the next Sub-Menu.

The last item in the list of choices is ****back****. Select ****back**** to return to the previous menu. The previous menu will be displayed such that your last selection will appear first on the menu. For example:

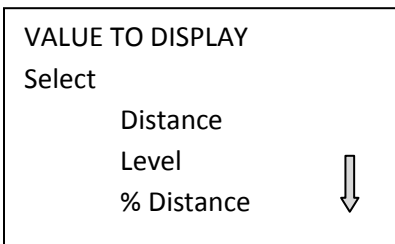

Figure 16 - Sub menu screens

III.2.2 Numeric menu style

The Numeric menu style presents you with a multi-digit number which may be modified. Navigate to each digit and modify the digit as required by using the Plus (+) or Minus (-) keys.

When you are done with all digits, select **Next** to move on. Select **Back** to ignore the changes and return to the previous sub-menu. Modifications will become permanent (survive a reset) when you navigate back to the measurement screen.

For example:

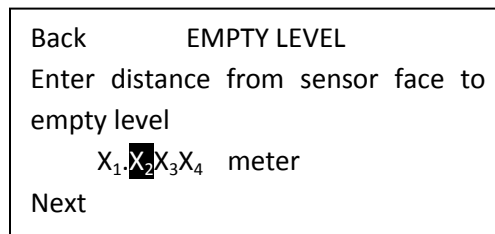

Figure 17 - Numeric menu

By repeatedly pressing the Right-Down navigation key, you will follow this route:

X₁ → X₂ → X₃ → X₄ → Next → Back → X₁ → X₂ → ...

Conversely, by repeatedly pressing the Left-Up navigation key, you will follow the opposite route.

After pressing **Next**, Gauger will check the validity of your numerical entry. If your entry is outside the acceptable boundaries, an ILLEGAL VALUE screen will be presented. You need to press any key to return to the previous screen. A default value will replace your wrong entry. If so needed, modify the numerical entry and press **Next** again.

III.3. Measurement screen

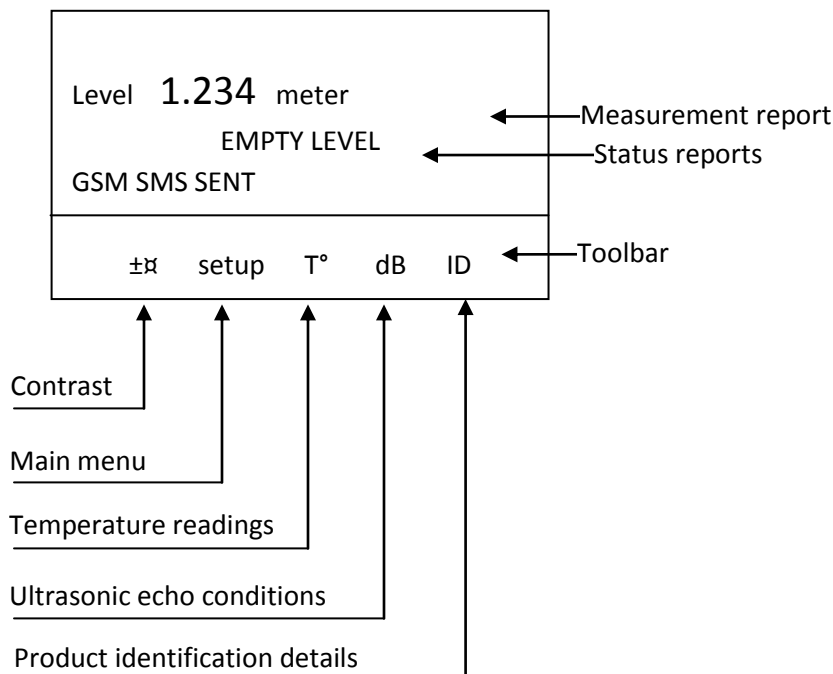

Figure 18 - Measurement screen

The top line presents the current measurement information.

III.3.1 Status reports

Status reports appear beneath the measurement result. On the first line, reports related to ultrasonic metering issues are presented. On the next line, cellular communication related reports are presented. Ultrasonic reports include messages such as: FULL LEVEL, EMPTY LEVEL, ECHO SEARCH, THEFT, START FILL, END FILL and others. Cellular related reports include messages such as SMS SENT, SMS ACTIVE, REGISTRATION FAILED and more.

The bottom line on the screen presents a toolbar with choices. Navigate through the toolbar and select an action or report. **GaugerGSM/485** halts any operations (including measurements) during navigation. **GaugerGSM/485** will automatically resume operations 30 seconds after last key has been pressed.

III.3.2 Contrast

Press the Plus (+) or Minus (-) keys to change visual contrast of the display.

III.3.3 Main menu / setup

Navigate to Setup and press Enter (+) to configure **GaugerGSM**. The actual configuration process is explained in a following chapter.

III.3.4 Temperature readings

Navigate to the T° symbol on the toolbar and press Enter (+). The following table will be displayed:

Sens:	Cur	High	Low
Int	29.5	31.0	26
Ext	29.4	32	23.3

Reset Done

Figure 19 - Temperature readings

The table is explained in the reference guide section: “Temperature sensors, units and display”. Press **Reset** to reset recorded high / low temperatures or press **Done** to return to the measurement screen.

III.3.5 Ultrasonic echo conditions

Navigate to the dB symbol and press Enter (+). You will be presented with the measured echo amplitude and the maximum amplitude available. The amplitudes are presented in dB relative to a system threshold amplitude. Echo amplitude should be above threshold amplitude for reliable measurement. Echo strength between 3dB and 8db (maximum) is reliable. Echo amplitude refers to the echo measured just prior to navigating through the toolbar. Press **Done** to return to the measurement screen.

III.3.6 Product identification details

From the measurement screen, navigate to the ID symbol on the toolbar and press Enter (+). Product information will be displayed: Serial Number and Part Number. Press **Back** to return to the measurement screen or navigate to one of the options: Software information (**SW**), Hardware information (**HW**) or Manufacturing Date information (**Date**).

SW screen will display firmware versions of the embedded application and of the embedded Boot-Loader. Press **Back** to return to the previous menu. HW screen will display product information regarding sensor type and model type. Press **Back** to return to the previous menu. Date screen will present the date of manufacturing. Press **Back** to return to the previous menu.

Menu mode is distinct from **measurement mode**. During regular measurements, display is in measurement mode and less responsive to key entries. In menu mode, user can navigate through the keys and setup options and keys are highly responsive. Shift Gauger from measurement mode to menu mode by pressing any first key a couple of times. Gauger will return to measurement mode 90 seconds or so after last key is pressed. Only then, measurement will resume.

IV. Configuration with the keypad and display

IV.1. Menu and sub-menu organization

GaugerGSM/485 menus and submenus are organized in a tree-like format. The organization is described in the following figure. Some of the sub-menus are not applicable for **Gauger485**.

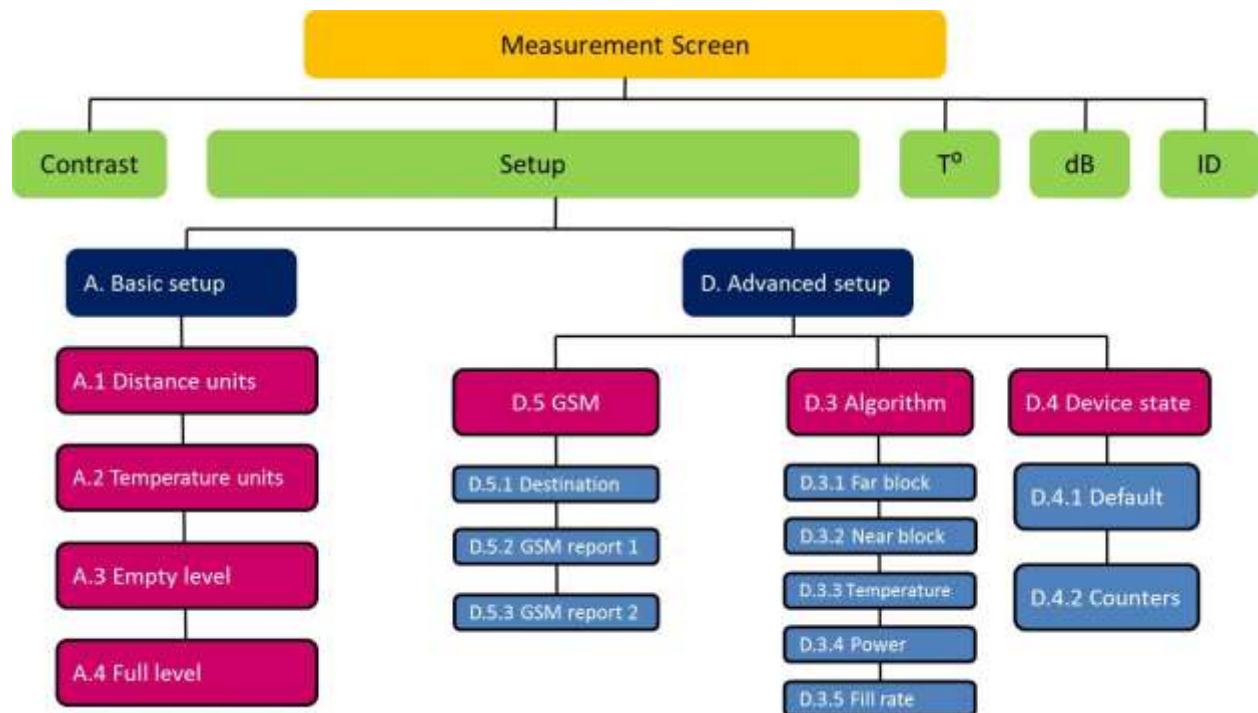

Figure 20 - Menu and submenu organization

Note: Depending on firmware version, False echo scan sub-menu may be positioned under Advanced setup (Algorithm).

IV.2. Quick Setup

Set **GaugerGSM/485** for operation by a quick 7-step wizard-driven procedure using the basic menu option.

Note: Configuration using the display and keypad supports metric units only. For American units, use the PC configuration method as described in the chapter describing configuration with a PC.

- a. Turn on **GaugerGSM** and wait for the measurement screen to show up. Navigate through the toolbar and select **setup**.
- b. Scroll and select **Basic Setup** from the Main Menu.
- c. Scroll and select application (Low power/ High power). For additional details about the application type refer to the reference guide chapter under: “Application type”.
- d. Determine distance to empty level. For additional details about the empty level see the reference guide section: “application dimensions and constraints”. When you are done press **Done**.
- e. Determine distance to the full level. For additional details about the full level see the reference guide section: “application dimensions and constraints”. When you are done press **Done**.
- f. Scroll and select value to display. For additional details about value-to-display see the reference guide section: “Distance units and value to display”.
- g. Skip false echo search. See the section “False echo scan by PC” in the reference guide chapter to apply this feature at a later time.

The Gauger is now ready for measurements.

Parameters which are not determined during quick setup procedure will take their default value and may be modified later using the Advanced Setup menu.

Note: Always verify then re-verify that your basic settings are correct including distance to empty level, distance to full level, level or distance choice. Most wrong readings originate from incorrect basic setup.

IV.3. Advanced settings

GaugerGSM/485 supports a set of advanced settings. These settings are classified under three categories: GSM, Algorithm and Device state. The following items may be modified under each category:

Category	Sub menu items	See section in reference guide...	Notes
GSM			
	Destination phone number	"Destination phone number"	
	Reporting interval	"GSM reporting interval"	
	Full and empty alerts		1-Enable 0-Disable
	Theft alerts	"Theft alerts"	00-disable
	Refill alerts	"Refill alerts"	00-disable
Algorithm			
	Far blocking distance	"Application dimensions & constraints"	
	Near blocking distance	"Application dimensions & constraints"	
	Filling rate	"Filling rate"	
	Temperature units	"Temperature sensors, units and display"	
Device state			
	Reset to defaults	"Reset and operating hours"	
	Operating hours	"Reset and operating hours"	

To execute any of the advanced settings, follow these steps: Turn ON **GaugerGSM/485** and wait for the Measurement screen to show up. Navigate and select **Setup**. Then scroll and select **Advanced Setup** from the Main Menu. Now select the required category (GSM, Algorithm or Device state) and follow the screen instructions. When done, scroll and press ****back**** to return to the Main Menu and then scroll and select the measurement display.

Each item may either present a selection of sub-items to choose from or may require entry of a numeric field.

If you are not sure what sub-item to select or how the numeric field should be modified, than leave the default values as is.

V. Configuration with a PC or Over-The-Air

V.1. Introduction

GaugerGSM/485 is pre-configured at the factory to default settings. See reference guide section: “Default Values”. The system is delivered to the user ready for operation. Some configuration parameters should be re-configured by the user for proper field application.

GaugerGSM/485 can be configured by a simple PC tool over a USB interface or over RS485. In addition, GaugerGSM can be configured over-the-air using SMS. The following sections in this chapter focus on configuration over USB interface. The last two sections will provide additional information as required for configuration over-the-air and for configuration over RS485.

Configuration by PC may be used in lieu of configuring with the integral keypad and display. PC configuration provides the user with the full set of configuration items. Furthermore, configuration by PC allows the user to clone fielded GaugerGSM/485 systems. For this cloning process, the user is required to prepare one text file and download that file into all relevant **GaugerGSM/485** systems. Once this configuration file is prepared, the downloading process takes a few seconds and makes redundant any manual keypad based operation.

Section 2 below begins by demonstrating a sample configuration text file.

Section 3 handles the downloading operation. The download process involves use of a standard Windows application – HyperTerminal. The setup of HyperTerminal is explained in the second section and parts of it may be skipped by those who are already familiar with this tool. Section 4 presents possible responses from **GaugerGSM/485** –whether good or erroneous responses. Section 5 is a list of all configuration items. Section 6 provides some configuration file example.

V.2. Preparing a configuration text file

V.2.1 Sample files

The following text file was created using Windows Notepad application and demonstrates the essence of the configuration file:

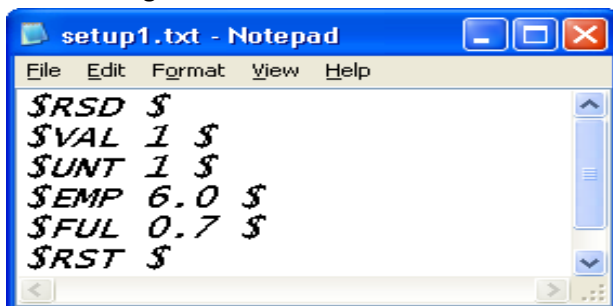

```
File Edit Format View Help
$RSD $
$VAL 1 $
$UNT 1 $
$EMP 6.0 $
$FUL 0.7 $
$RST $
```

Digest line by line:

- Reset **GaugerGSM/485** to its default values.
- Value to Display is LEVEL
- Unit system is Metric
- EMPTY LEVEL is set to a distance of 6.0 meters
- FULL LEVEL is set to a distance of 0.70 meters
- Restart **GaugerGSM/485**.

After RST, it is advisable to disconnect power from the Gauger and reconnect again.

If you are unfamiliar with terms such as empty level or full level read reference guide section: “Application dimensions and constraints”. Next is a slightly more complex configuration file:

A more advanced example:

```

$RSD $
$VAL 2 $
$UNT 1 $
$EMP 5.55 $
$FUL 0.45 $
$TELL +49-1-12345667- $
$SMST 1800 $
$RST $

```

Digest:

- The sixth line instructs a set up the destination phone number to +49-1-1234567
- The seventh line instructs GaugerGSM/485 to set up SMS interval time to 1800 seconds
- The last line is a restart and the user is advised to disconnect and then reconnect power

Finally, an example featuring a multi valued command:

```

$RSD $
$VAL 3 $
$UNT 1 $
$EMP 5.5 $
$FUL 0.45 $
$CYLV 4.50, 3.00, 0 $
$RST $

```

Digest:

Some configuration items are assembled from two values or more. For example, the dimensions of a vertical cylindrical tank (prefix CYLV) are height, diameter and thickness of curved bottom. All values are included with a **comma in between** any two values. The figure above illustrates the use of the comma.

The second line instructs **GaugerGSM/485** to display VOLUME results (rather than LEVEL or DISTANCE).

The third line instructs **GaugerGSM/485** to display volume in liters.

The last line instructs **GaugerGSM/485** to set the tank as a **vertical cylindrical tank** with **height** of 4.5 meter, **diameter** of 3.00 meters and flat bottom floor. **Comma separates** the values on the same line.

V.2.2 Configuration text file - summary notes

- Each line begins, and ends, with a **\$ sign**.
- Commands are case insensitive.
- Each command is immediately adjacent to the first \$ sign.
- There is one space between the command and the next parameter.
- In multi-parameter commands, parameters are separated by a comma.
- It is highly recommended to begin each configuration file with **RSD** then **VAL** then **UNT**.
- It is highly recommended to end each configuration file with **RST** and then disconnect / reconnect power.

Other combinations, while not illegal, may result in setup misinterpretation.

V.3. Download operation

V.3.1 Procedure

GaugerGSM/485 can be configured by downloading the text configuration file from your PC into **GaugerGSM/485**. The previous chapter described the making of the configuration file. This chapter describes the **download procedure**. The download process can be performed using **HyperTerminal** – a Microsoft standard application which is part of Windows XP and earlier versions. HyperTerminal application can be copied to Windows 7. Similar applications may also be used.

Prior to using the HyperTerminal, you must connect **GaugerGSM/485** to the PC and install a USB-Serial driver on the PC. You can do that by following the instructions in the chapter: “USB driver installation on a PC”.

Find out the COM port number that **GaugerGSM/485** is using on the PC. **GaugerGSM/485** must be in the measurement screen during download procedure. Two PC applications trying to access **GaugerGSM/485** will conflict with each other. Avoid having two such applications running at the same time.

V.3.2 Launching and setting up HyperTerminal

This section assumes you are using Windows XP. Similar procedures apply to other operating systems.

V.3.2.1 Go to Start Menu and then Open Programs.

V.3.2.2 Open Accessories, then Open Communications then Open HyperTerminal.

V.3.2.3 Press NO when asked about “default telnet program”

V.3.2.4 When prompt for a name, choose any name and press OK.

V.3.2.5 In the next window “Connect to”, select the COM port that you intend to use for GaugerGSM.

This part is described in the next figure:



V.3.2.6 In the next window “COM properties - port settings” set the parameters as described below:

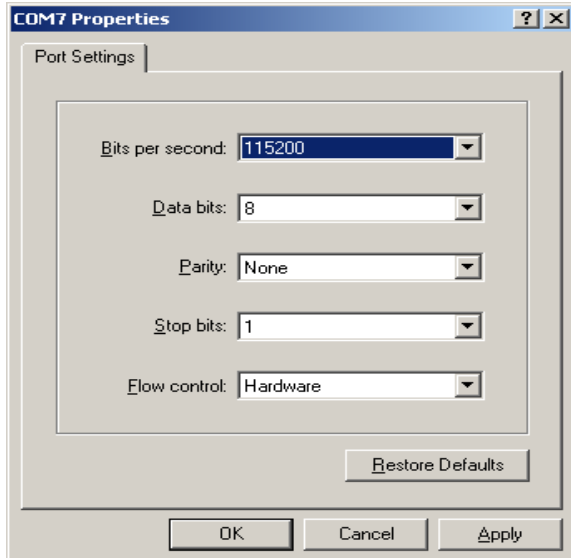

V.3.2.7 Now you should see the HyperTerminal screen:

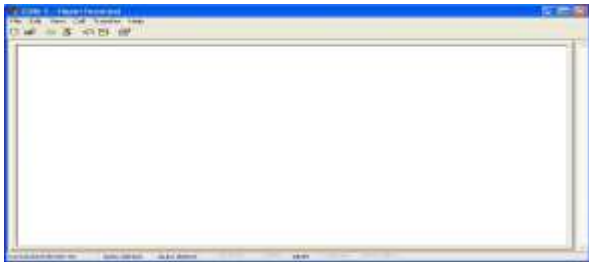

V.3.2.8 Select the File tab (on the top left side) and choose properties then settings and set the parameters as described below:

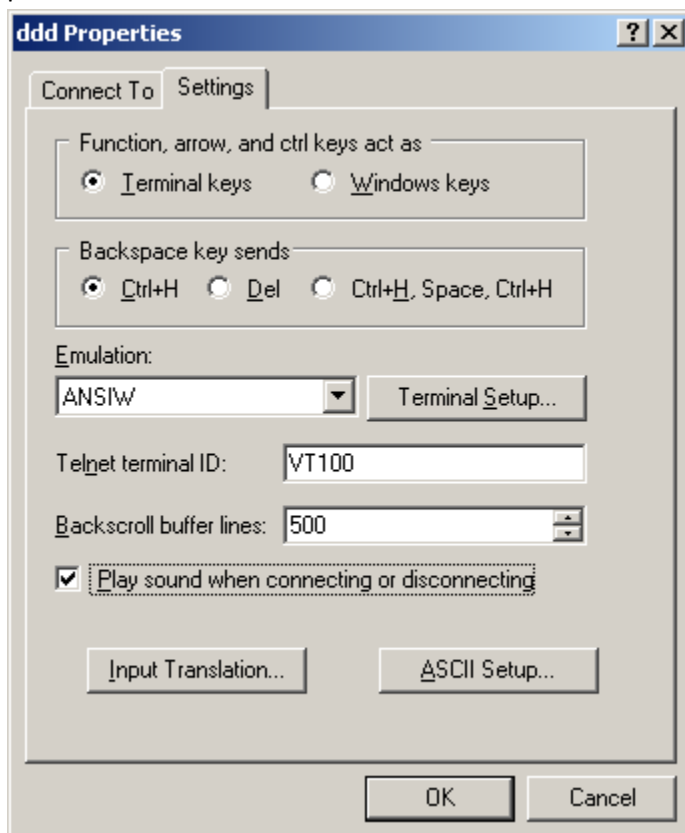

V.3.2.9 Now press on ASCII setup (bottom right side) and set the parameters as described below:

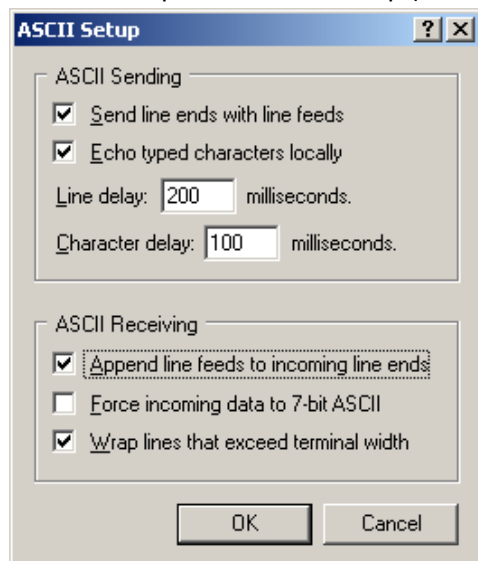

Especially note the “Line Delay” and the “Character delay” which **are not** the default values of HyperTerminal.

Note: When using the USB port for local serial data monitoring (see appropriate chapter), you should return to the default values of the screen above and specifically uncheck “Append line feeds to incoming line ends”. And vice versa, if you revert to configuration of GaugerGSM through the USB interface, make sure to set the parameters of the screen above correctly.

V.3.2.10 Press OK and then OK again – **you are all set to configure GaugerGSM/485.**

V.3.3 Downloading a configuration file

V3.3.1 From the HyperTerminal screen select transfer (top right side tab) and then select “Send Text File”.

V.3.3.2 Browse to the directory where you stored the configuration text file (the one you prepared in the previous section) and select that file. Double click on the file to transmit it.

V.3.3.3 Alternatively, you can key each configuration item line by line directly from the HyperTerminal screen. As a quick test of this configuration, key the following command: \$VAL 1 \$

Watch **GaugerGSM/485** integral display and verify that measured data is Level.

Now key the following command: \$VAL 2 \$

Watch **GaugerGSM/485** integral display and verify that measured data is Distance.

V.4. Responses from GaugerGSM/485

V.4.1 Good response

GaugerGSM/485 should reply with an **OK response** to each command accompanied by the command name. In some cases, the values that have been changed are also printed. The next example shows five legal commands.

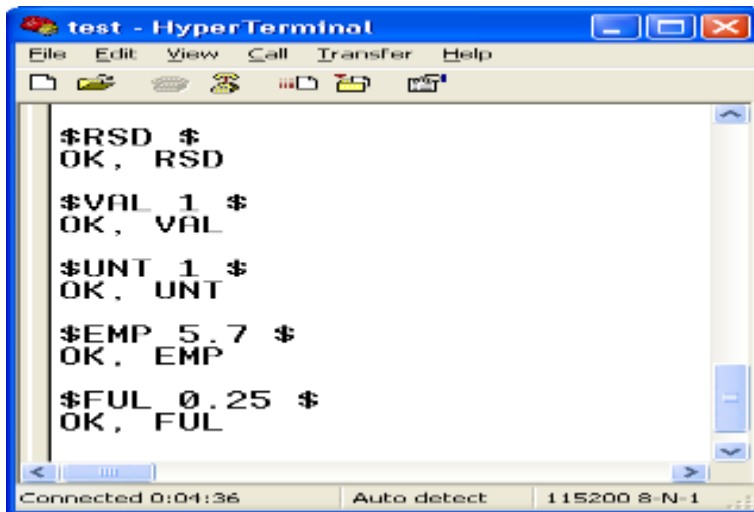

```
test - HyperTerminal
File Edit View Call Transfer Help
$RSD $
OK, RSD

$VAL 1 $
OK, VAL

$UNT 1 $
OK, UNT

$EMP 5.7 $
OK, EMP

$FUL 0.25 $
OK, FUL

Connected 0:04:36 Auto detect 115200 8-N-1
```

V.4.2 Erroneous responses

GaugerGSM/485 will reply with an **ERROR** response to a wrong configuration item.

In the next example:

EMP = 8.9 meters is illegal for GaugerGSM/485-75 (maximum is 8 meters) and will produce ERROR #5: Value exceeds upper limit.

FUL = 0.13 meters is illegal for GaugerGSM/485 (minimum is 0.15 meters) and will produce ERROR #6: Value is below lower limit.

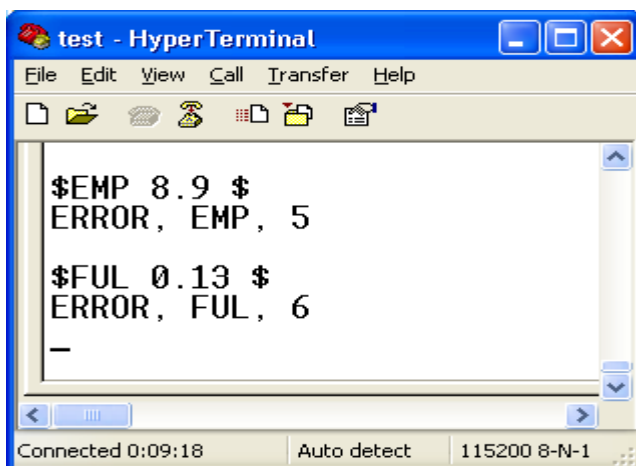

```
test - HyperTerminal
File Edit View Call Transfer Help
$EMP 8.9 $
ERROR, EMP, 5

$FUL 0.13 $
ERROR, FUL, 6

-

Connected 0:09:18 Auto detect 115200 8-N-1
```

Additional errors may occur if command is wrong. In the next example, the non-existent command EGP results in ERROR#4 and a non-existent value (VAL=9) results in ERROR#7.

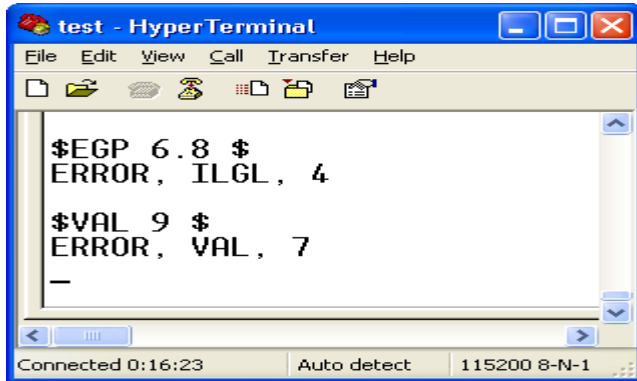

Finally, misalignment of \$ signs may occur as follows:

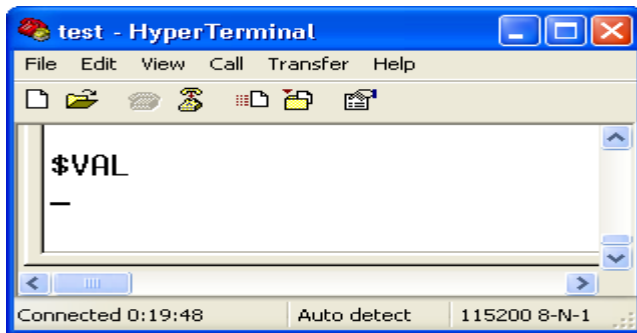

In the example above, the closing \$ was not typed and the system is waiting for this \$ sign. In these cases, type \$ and re-enter the complete command as follows:

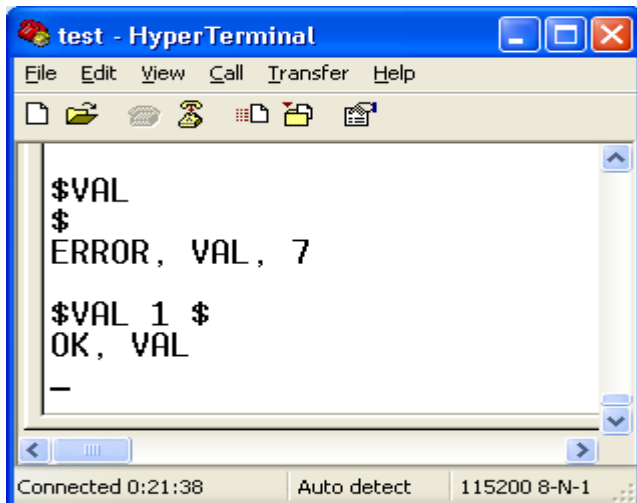

Some of the common error numbers are listed below:

Error code	Most probable cause
4	Wrong command name or command not adjacent to \$ sign
5	Value is exceeds upper legal limit
6	Value is below lower legal limit
7	Value is illegal

V.4.3 Communication Errors

The erroneous responses described indicate that the link between PC and GaugerGSM is operating fine and that the commands are of wrong nature.

If no responses are received from GaugerGSM/485 or if the responses carry unfamiliar characters, the communication link between the PC and GaugerGSM/485 is not performing. In this case, you need to check the physical cabling, verify the HyperTerminal settings and then restart this application again.

V.5. List of commands for configuration from a PC

V.5.1 Conventions

The following conventions apply for the list of commands. These conventions refer to the values allowed for each parameter.

V.5.1.1 Range of number values

A range of number values is presented with a hyphen. For example: **0.150-8.000**. This entry means that the value may be any number between 0.150 and 8.000. Always use the decimal point. The number of decimal digits may be less than three.

V.5.1.2 Range of whole number values

A range of whole number values is presented with a hyphen. For example: **1-99**. This entry means that the value may be any whole number between 1 and 99.

V.5.1.3 Several distinct values

When a parameter can be one of a few distinct values, each value is listed on separate lines with an explanation. For example:

Command	Command Description	Possible values	Value description
VAL (³)	Value to display	1	Level
		2	Distance
		3	Volume (set also tank shape)

V.5.1.4 Two parameters for the same command

An entry such as **1-9999 , 0.150-8.000** means that the command is made of two parameters and requires two values. A comma separates the two values. In this example the first value may be any whole number between 1 and 9999. The second value may be any number between 0.150 and 8.000.

V.5.1.5 Two parameters with one parameter fixed

An entry such as **1-99 , 0** means that the configuration item requires two values but the second value must be 0. The first value in this example may be any whole number between 1 and 99.

V.5.1.6 Text parameters

The entry "text" means that the command requires a text field. The text field must be enclosed in double quotes. The text field cannot contain a comma or a \$ sign. A blank text field is presented by two adjacent double quotes: "". A text field may contain up to 30 characters.

The user may select Metric or American unit systems. The list below provides a line item for each unit system as applicable. The user selects a unit system with UNT command.

This page is intentionally left blank.

Proceed to the next page for Gauger Command List.

V.5.2 Command list

Instruction for use of the command table:

- The list applies to Gauger systems at 75 KHz. For Gauger systems / 50 KHz numerical boundaries should be adjusted as follows:

0.15 m	→	0.35 m
8.000 m	→	9.500 m
0.5'	→	1.2'
26'	→	31'

- Both Metric and US unit systems are present.
- Unless specifically defined otherwise, length units are meters in the metric unit system and feet in the US metric system (see also section Distance Units and Value to Display in Reference chapter IX)
- Default values are underlined.
- Browse through the table sections one-by-one top to bottom.
- Select commands from each relevant section and skip other commands.
- Ignore commands which are not clarified in the table (to be used only as recommended by the manufacturer).
- Apply any relevant commands in the order they appear in the table.
- See several typical examples following the table.

#	Command	Explanation	Parameters	Details in Reference Chapter, section...
Basic Settings				
1	\$RSD \$	Reset to factory defaults		Reset and operating hours
2.1	\$UNT N \$	Unit system	<u>1</u> =Metric, 2=US	Distance units and value to display
2.2	\$TMP N \$	Temperature units	<u>3</u> =Celsius, 4=Fahrenheit	Temperature sensors & units
3.1	\$SNS N \$	Temperature sensor	<u>0</u> =Internal, 1=External, 2=Average	Temperature sensors & units
3.2	\$FUL X \$	Distance "sensor to full"	<u>0.150</u> ≤X≤8.000; US: <u>0.50</u> ≤X≤26.00	Application Dimensions
3.3	\$EMP X \$	Distance "sensor to empty"	<u>0.150</u> ≤X≤ <u>8.000</u> ; US: <u>0.50</u> ≤X≤ <u>26.00</u>	Application Dimensions
Volume and Open Channel Flow Settings				
3.4.1	\$CUB X,Y \$	Cubic tank volume. X=width, Y=Horizontal depth.	0.01≤X≤99.99; US: 0.01≤X≤299.99 0.01≤Y≤99.99; US: 0.01≤Y≤299.99	Volume measurement
3.4.2	\$CYLV X,Y,Z \$	Vertical cylindrical tank. X=Height (=EMP), Y=Diameter, Z=Breadth of bottom.	0.01≤X≤99.99; US: 0.01≤X≤299.99 0.01≤Y≤99.99; US: 0.01≤Y≤299.99 0≤Z≤10.0; US: 0≤Z≤29.9	Volume measurement

3.4.3	\$CYLH X,Y,Z \$	Horizontal cylindrical tank. X=Length, Y=Diameter, Z=Breadth of curved sides.	0.01≤X≤99.99; US: 0.01≤X≤299.99 0.01≤Y≤99.99; US: 0.01≤Y≤299.99 0≤Z≤10.0; US: 0≤Z≤29.9	Volume measurement
3.5.1	\$TBL N,X,Y \$	Mapping table. N=index, X=Level, Y=Mapped value (volume or flow).	N=1..32, 0≤X≤max value in cm or inches; (For 75KHZ: 785cm or 314 inches). For volume: enable with TVOL For flow: enable with OCF 99.	Mapping Table
3.5.2	\$STBL N \$	Show mapping table. N=# of entries. If N is omitted, all 32 values are displayed.	N=1..32	Mapping Table
3.5.3	\$TVOL K, M \$	Volume based on mapping table (volume vs. level). K - Number of entries from the table M - Volume unit system	1 < K ≤ Entries in table. M=0 (Liter) or 1(Gallon)	Mapping Table
3.6.1	\$OCF 1,N,X,M \$	Rectangular suppressed sharp crested weir. N=Unit system. X=Crest length. M=Flow units.	N=0 or 1 (variable in cm or inch). 20≤X≤300 cm or 12≤X≤96 inch. M= 0 – flow in cubic meter per hour 1 – flow in cubic feet per second 2 – flow in Gallons per minute 3 – flow in liter per second 4 – flow in Million gallons per day	Open Channel Flow
3.6.2	\$OCF 2,N,X,M \$	Rectangular contracted sharp crested weir.	Same as OCF 1.	Open Channel Flow
3.6.3	\$OCF 3,N,X,M \$	Trapezoidal (Cipolletti) sharp crested weir	Same as OCF 1.	Open Channel Flow
3.6.4	\$OCF 4,0,X,M \$	V-Notch (Triangular) sharp crested weir. X=Notch angle in degrees.	22.5≤X≤90.0 Otherwise same as OCF 1.	Open Channel Flow
3.6.5	\$OCF 5,N,X,M \$	Parshall Flume. X=Throat width.	15≤X≤360 cm or 6.0≤X≤144.0 inch Otherwise same as OCF 1.	Open Channel Flow
3.6.6	\$OCF 6,N,X,M \$	Palmer-Bowlus Flume. X=Conduit diameter.	15≤X≤75 cm or 6.0≤X≤72.0 inch. Otherwise same as OCF 1.	Open Channel Flow
3.6.7	\$OCF 7,N,X,M \$	H-Flume. X=Flume size. N, M same as above.	15≤X≤135 cm or 6.0≤X≤54.0 inch. Otherwise same as OCF 1.	Open Channel Flow
3.6.8	\$OCF 8,N,X,M \$	Leopold-Lagco Flume. X=Conduit diameter (inch).	4≤X≤72 inch. N=1. Otherwise same as OCF 1.	Open Channel Flow
3.6.8.1	\$OCF 9,N,X,M \$	Khafagi-Venturi Flume. X=Flume width (cm).	US12≤X≤160 cm. N=0. Otherwise same as OCF 1.	Open Channel Flow

3.6.9.1	\$OCF 10,N,X,Y,Z,M \$	Manning flow for circular pipes. X=Slope of pipe, Y=Roughness, Z=Pipe diameter, N=units for diameter, M=Flow units.	0.001≤X≤1.000, 0.001≤Y≤0.200, 15≤Z≤900; US: 6≤Z≤350 Otherwise same as OCF 1.	Open Channel Flow
3.6.9.2	\$OCF 11,N,X,Y,Z,M \$	Manning flow for rectangular pipes. X=Slope of pipe, Y=Roughness, Z=Pipe width, N=units for diameter, M=Flow units.	0.001≤X≤1.000, 0.001≤Y≤0.200, 15≤Z≤900; US: 6≤Z≤350 Otherwise same as OCF 1.	Open Channel Flow
3.6.10	\$OCF 99,N,K,M \$ (version dependent)	Flow based on mapping table (flow Vs. level). N=Unit system for Level. K=number of table entries to use.	K=3..32. Otherwise same as OCF 1. To be used with \$TBL	Open Channel Flow
3.6.11	\$OCF 0 \$	Disable previously defined OCF.		Open Channel Flow
Advanced installation settings				
3.7	\$NBD X \$	Set Near Blocking Distance	0.150≤X≤8.000; US: 0.50≤X≤26.00	Application Dimensions
3.8	\$FBD X \$	Set Far Blocking Distance	0.150≤X≤8.000; US: 0.01≤X≤26.00	Application Dimensions
4.1.1	\$RAT N \$	Filling / tracking rate. Depending on firmware version, you may need to use the following command with M=2.	0=Low-rate, 1-2=Mid-rate (5meter/min), 3-4=High-rate (10meter/min). US: mid=15'/min, high=30'/min.	Filling Rate
4.1.2	\$RAT N,M \$	Filling / tracking rate and temperature filter	N: same as above M: 0=heavy filter, 1=mid filter, 2=light filter.	Filling Rate
4.2.1	\$TCOF X,Y \$	Thermal expansion. X=Reference temperature, Y=Volumetric temperature coefficient (ppm).	0≤X≤100; US: 32≤X≤212 0≤Y≤3000	Temperature Coefficient of Expansion
4.2.2	\$DCOR N,X,Y\$	Correction for time of day. STEL must be set for this command.	N=Table entry (0..3) X=Time in whole hours (1..24) in ascending order. Y=Distortion to Distance in mm (positive or negative).	Correction for time of day
4.2.3	\$DCOR \$	Displays DCOR entries		
4.3	\$GCOF X \$	Gas velocity correction. X=coefficient.	0.3≤X≤5.0 (x=1)	Gas Velocity Coefficient
4.4.1	\$FES \$	List ultrasonic echoes.		False Echo Scan by PC
4.4.2	\$FES N\$	Set echo N as false.	N=0..8	False Echo Scan by PC
4.5.1	\$APP X \$	Ultrasonic power	0=high, 1=Low, 2=Very high, 3=Zone dependent.	Application Type
4.5.2	\$PIPE X \$	Improve operation with extension pipe	X = length of extension pipe in meter or	

			feet. (X in meter<2.5, X in feet<8.2)	
4.6	\$VAL N \$	Value to display	1=Level, 2=Distance, 3=Volume, 4=%Level, 5=%Distance, 6=%Volume, 7=Flow, 8=%Flow, 9=Totalization.	Distance units and value to display
Handling Rough targets				
5.1	\$FILT N \$	Ignore intermittent echoes.	0=Do not ignore any echo. 1=Ignore only short echoes...20=Ignore long duration echoes.	
5.2	\$FACT X \$	Handles range harmonics	X=3.5	
5.3	\$MIX N \$	Averaging process	0=Light average, 4, ...100=Heavy average	
5.4	\$ ZONE \$			
6. Interfaces and alerts				
6.1 Gauger420 only				
6.1.1.1	\$TWOW X,Y,20,N,M \$	Configuring 4-20 output for LEVEL or FLOW or VOLUME or DISTANCE.	X=Level/flow/volume/distance at 4mA. Y=Level/flow/volume/distance at 20mA. N=0 (set 4-20 for level) N=1 (set 4-20 for flow) N=2 (set 4-20 for volume) N=3 (set 4-20 for distance) M=0 (error is 3.6mA) M=1 (error is 22mA) M=2 (error is hold last value) M=3 (error is nearby 3.6mA or 22mA)	4-20 Communications
6.1.1.2	\$TWOW 0,0,Z,4,M \$	Configuring 4-20 output for fixed current.	4<Z<20 is fixed current. M=0..3 see above.	4-20 Communications
6.1.2	\$HART P,S,T,Q,N,M \$		P,S,T,Q are PV, SV,TV,QV: 0-Distance, 1-Level, 2-Volume, 3-Temperature, 4-%Distance, 5-%Level, 6-%Volume, 7-Flow, 8-%Flow. M=0..15 HART device N=1 HART enable, =0 HART disable	HART Communications
6.2 GaugerGSM only - communications				
6.2.1	\$SMST N \$	SMS/GPRS message periodicity in seconds.	0=no periodic messages. 60≤N≤3999999 (N=1800) (60 is version dependent)	GSM reporting interval
6.2.2	\$STEL N \$	Add time stamp to GPRS messages. N is	N=14 character word. Each character is a	

		the Gauger SIM cellular number.	digit or *or – or +.	
6.2.3	\$DATA N \$	Type of GSM message	0=SMS, 1=GPRS, 2=SMS with Vin/RSSI, 3=GPRS with Vin/RSSI. 4=GPRS with Vin/RSSI and Time Stamp. STEL must be defined for “4”.	GPRS Message Format
6.2.4	\$RSM N \$	Self-reset for cellular communication problems.	0=enabled. 1=disabled.	
6.2.5	\$CAL N \$	GPRS variations	N=1..15	
6.3 GaugerGSM only - alerts				
6.3.1	\$ARF X,Y,N \$	Alert for refill. X is threshold in level. Y is threshold in volume. Use only X or Y. N is duration threshold in minutes.	X=0, Y=0, Z=1 no alert. 4≤X≤99;US: 0.16≤X≤3.8 (mm or inch) 5≤Y≤500; US: 1.4≤X≤26.0 (liter or Gallon) N=1..3	Refill alerts
6.3.2	\$AFE N \$	Alerts for Full and Empty	0=no alerts. 1=alerts active.	Full and Empty alerts
6.3.3	\$ATF X,Y \$	Alert for high consumption (“theft”). X is threshold in level. Y is threshold in volume. Use only X or Y.	X=0, Y=0 no alert. 4≤X≤99;US: 0.16≤X≤3.8 (mm/minute or inch/minute) 5≤Y≤500; US: 1.4≤X≤26.0 (liter/minute or Gallon/minute)	Theft alerts
6.3.4	\$TRGR N,M,X,Y,Z \$	Level/volume crossing alerts. N is triggering type. M sets level or volume. X,Y,Z is activation percentage for first, second and third trigger.	N= 0 - Trigger upon upward crossing. 1 - Trigger upon downward crossing 2 - Trigger both ways. 3 - No triggers. For this case, if PTS and LPST are defined, status field will follow LPST definitions. M= 1 - Trigger is set for level. 2 - Trigger is set for volume. 3 - Trigger is set for distance. 0≤X≤100 percent for first trigger. Y and Z – same but for second and third trigger (optional).	Trigger alerts

6.3.5	\$ALRT S,T,V,W \$	Temperature and voltage alerts. Temperature crossing below S or above T will trigger an alert message. Voltage crossing below V or above W will trigger and alert message.	-30≤S≤T≤70. US: -20≤S≤T≤158 6≤V≤W≤35. T and S are in Celsius or Fahrenheit. V and W are in Volts.	
GaugerGSM only - SMS				
6.4	\$TEL1 N \$	SMS destination number.	N=14 character word. Each character is a digit or *or – or +.	Destination phone number
GaugerGSM only – GPRS				
6.5.1	\$NAME A \$	Unique name for Gauger identification by server.	A is up to 30 characters. No spaces, comma or \$ are allowed.	GPRS architecture
6.5.2	\$GPRS "U","W","N",A,P \$	Defining network and server	U=GPRS username. W= GPRS password. N=APN. A=Server IP address or http name (no spaces). P=Destination port (0-99999). U, W and N should be enclosed by double quotes. If username and/or password are blank use ""	GPRS architecture
GaugerGPS only - GPS				
6.6	\$GPS N \$	Activate or disable GPS read and transmit.	1=Activate. 0=Disable.	
Special modes of operation – PTS / Logger / BUS / Relay / RS485 / USB				
7.1	\$LPST N,X,M,Y,K,L \$	Set timer for low power mode	N=2..99999(long standby/minutes) X=Distance to lowest zone. M=2..99999(short standby/minutes) Y=Distance to high zone. K=0(disable), 1(enable), 2(no GSM). L=0(no messages in long standby), 1(one message in long standby), 2..N (log messages then burst up to 20 for SMS or 100 for GPRS)	PTS configuration
7.1.1	\$DLOG X,N,Y,M,X,K \$	Set logger depth (N, M and K) for each of the three zones defined in LPST command. Override LPST time intervals with X, Y and Z time intervals.	X, Y, Z - sleep interval in minutes at low, mid and high zones respectively. N, M, K - logger depth for low zone, mid zone and upper zone (≤100 for GPRS and ≤20 for SMS). Zero ("0") may be used to disable logger messages at a specific zone. One ("1") may be used to retain logger message format with one point only.	Logger Operation

7.2	\$PTS N \$	PTS sleeping options	0=Allow sleeping in all zones, 1=Always awake at upper zone, 2=Awake at all zones.	PTS configuration
7.3	\$MBS X,Y,Z \$	GaugerBUS settings	X=0(off), 1(Slave), 2(Master). Y (For slave - device index. For Master – slave count). Z=1 (distance), 2(level), 3(volume), 4(flow).	GaugerBUS
7.4	\$RLY N,X,M,Y \$	Defines relay A operation	N=0(off), 1(set by display VAL). 2(theft). X=Activation value. M=1(short above X), 0(open above X). Y=Hysteresis value (return at X-Y).	Relay Truth Table
7.4.1	\$ERLY R1, R2, R3, R4, R5, R6, R7, R8 \$	Defines external relay device operation.	Rk=-1: relay k is not active. Rk=X: relay will turn ON if Gauger VAL (display) value is above X.	Relay Device
7.5.1	\$ENDT \$	Enable serial monitoring		Serial data monitoring
7.5.2	\$DSDT \$	Disable serial monitoring		Serial data monitoring
Debugging				
8.1.1	\$STAT 0 \$	Reports internal settings via USB.		
8.2	\$TEST A,B,C,D,E \$	Initiate up to 5 quick SMS/GPRS messages at turn on.	A..E = 1..60 (minutes) are time intervals from turn-on to transmitted message.	Test mode during Installation
8.3	\$MLOG N \$	Report GSM operations via USB port.	0=Cancel reports. 1=Report GSM signal strength (2 is low, 32 is high). 2=Report internal modem responses.	
8.4	\$DBG	Report debugging information over GPRS direct to the manufacturer internet server.	0 = Disabled. 1=enabled.	
8.5	\$GMAN \$	Get manufacturing data (serial number and manufacturing date)		
8.6	\$IMEI \$	Get the "International Mobile Station Equipment Identity" (IMEI) of the internal modem.		
Reset				
9.1	\$RSC \$	Reset hour counter		Reset and operating hours
9.2	\$RST \$	Restart Gauger		Reset and operating hours

V.6 Useful examples

Command order should preferably follow the order presented in the table above.

V.6.1 Basic setup

\$RSD \$	Reset to factory defaults
\$UNT 1 \$	Unit system is Metric
\$FUL 0.15 \$	Distance to full is 0.15 m
\$EMP 7.2 \$	Distance to empty is 7.2 m
\$APP 0\$	High power
\$VAL 1 \$	Display LEVEL
\$RST \$	Reset the Gauger after setup

V.6.2 Advanced setup

\$RSD \$	Reset to factory defaults
\$UNT 1 \$	Unit system is metric
\$TMP 3 \$	Temperature unit is Celsius
\$SNS 0 \$	Temperature sensor is the internal
\$EMP 5.3 \$	Distance to empty is 5.3 m
\$CYLV 5.0, 2.0, 0.0 \$	Tank is vertical cylindrical, height 5m, diameter 2m, straight bottom.
\$NBD 0.4 \$	Near blocking distance is 0.4 m
\$FBD 5.4 \$	Far blocking distance is 5.4 m
\$RAT 3 \$	Fast tracking (10m/min)
\$VAL 3 \$	Display VOLUME
\$SMST 1800 \$	Interval between messages is 30 minutes
\$DATA 2 \$	SMS messages
\$ARF 8, 0, 2 \$	Refill alerts ON for minimum refill of 8 mm during 2 minutes
\$AFE 1\$	Empty and Full event alerts are on
\$ATF 4, 0 \$	Theft alerts ON and for rate above 4 l per minute
\$TEL1 +49-25-4678911- \$	Cell-phone destination is +49-25-4678911
\$LPST 60, 6, 10, 3, 1, 1 \$	Low power timer is ON: Low level sleep time of 60 minutes when the distance to target above empty-level but and longer than 6 meters. High level sleep time is 10 minutes and occurs when distance to target is more than 3 meters but still less than 6 meters. GaugerGSM will operate continuously when the distance to target is less than 3 meters and transmit a message once per SMST if PTS=1. GaugerGSM will sleep for SMST interval if PTS=1.
\$TRGR 1, 0, 25, 50 \$	Two triggers are defined. One for 25% level and another for 50% level. The alerts are only when level is decreasing.
\$RST \$	Reset the Gauger after setup

For an example on using LPST and DLOG see Reference Chapter IX section: Logger Operation.

V.6.3 GPRS setup example

\$RSD \$	Reset to factory defaults	
\$EMP 4.5 \$	Empty level is 4.5 meter	
\$VAL 2 \$	Value to display is distance	
\$SMST 7200 \$	Interval between messages is 2 hours	
\$DATA 3 \$	GPRS transmissions (including Vin and RSSI)	
\$NAME River_south \$	Gauger name is "river_south"	
\$GPRS "t-mobile", "tm", internet.t-mobile", 191.16.12.1, 19500 \$	(*) See below	
\$RST \$	Reset the Gauger after setup	

(*) This example is taken from t-mobile Germany: APN of the cellular network is internet.t-mobile, username for the network is t-mobile and password is tm. The destination server holds IP address of 191.16.12.1 and port number 19500.

Note that username and password of many cellular providers is blank. In this case the command should begin as follows: \$GPRS "", "", "apn" etc...

Also note that a URL may replace the IP address. This is not recommended if GPRS network is slow.

V.6.4 OCF – Flow Mapping Table example (American Units)

\$RSD \$	Reset to factory defaults	
\$UNT 2 \$	Unit system is American	
\$EMP 3.5 \$	Empty level is 3.5 feet	
\$TBL 1, 0, 0 \$	Four mapping points are defined for table. Zero (0) level is mapped to 0 flow, level of 10 is mapped to flow 110.8, level of 20 is mapped to flow 150. Level and Flow units are defined in the following OCF command.	
\$TBL 2, 10, 110.8 \$		
\$TBL 3, 20, 150 \$		
\$TBL 4, 25, 255.0 \$		
\$OCF 99, 1, 4, 3\$	Calculate flow using four entries of table. The table defines Level in inches and flow in Liter/Sec. In older firmware versions use OCF 11.	
\$RST \$	Reset the Gauger after setup	

Note: Always verify then re-verify that your basic settings are correct including distance to empty level, distance to full level, level or distance choice. Most wrong readings originate from incorrect setup.

V.7 Configuration Over-The-Air (OTA) by SMS

Configuration Over-The-Air is not supported by all GaugerGSM systems. Check with the manufacturer whether your version supports configuration Over-The-Air.

GaugerGSM may be configured over the air using SMS messages. Configuration SMS can be sent from any cellphone, PC application or similar. Destination number is the cellular number of the SIM card which is inserted within the Gauger.

The Gauger checks for incoming configuration SMS every few minutes. Once a legal configuration SMS is received, the Gauger will reconfigure itself and will then reset itself. The Gauger will send a standard data message after reset.

The text of a configuration SMS is: **\$command parameter/s\$** where command and parameters are same as in the USB commands (Section V.5.2).

Note: No blanks are allowed except for one blank between the command and the first parameter. In particular, the first \$ sign should be the first character in the message, to be followed by the command with no spaces. The closing \$sign should follow the last parameter with no blank in between.

Concatenation of commands is allowed with one \$ sign in between two commands.

Examples:

Legal	Not Legal
\$FUL 0.2\$	\$ FUL 0.2\$
\$FUL 0.2\$EMP 2.4\$	\$FUL 0.2\$ \$EMP 2.4\$
\$FUL 0.4\$EMP 6.5\$NBD 0.9\$	\$FUL 0.4\$EMP 6.5\$ NBD 0.9\$
\$TEL1 ----1234567890\$	\$TEL1 ----1234567890 \$

Due to the non-guaranteed characteristics of the SMS system, users are encouraged to check the messages arriving from the Gauger to ensure re-configuration was accomplished.

Configuration SMS may be sent to GaugerGSM which is “asleep” under PTS control. Typically, the SMS will be delivered to the Gauger 1-2 minutes after the Gauger is turned on. This type of cellular service (delayed SMS) may not be supported by all cellular operators.

V.8 Configuration Over RS485

Configuration over RS485 is not supported by all Gauger systems. Check with the manufacturer whether your version supports configuration over RS485.

Configuration over RS485 is a special mode of operation. In this configuration mode, the Gauger does not measure and does not report any measurement data either wired or wireless. Once in this configuration mode, the Gauger will automatically return to measurement mode after 30 seconds of inactivity. Entry to RS485 configuration mode is performed at turn-on of the Gauger and as described in the following procedure:

- (a) Connect the Gauger to a PC over RS485 interface. Use adapters as required on the PC side.
- (b) While the Gauger is off, turn on the PC and launch HyperTerminal over the RS485 interface.
- (c) Press the # key continuously on the PC keyboard and while pressing, turn the Gauger on.
- (d) The Gauger should enter the configuration mode and display "SEND USB 485 COMMAND".
- (e) Send configuration commands from the HyperTerminal over RS485.
- (f) When done, wait for 30 seconds for the Gauger to return to the standard measurement mode.

Depending on the characteristics of your RS485 interface, you may be required to add a parallel resistance (1700 Ω or 3300 Ω) on RS485 lines. Also, in some cases, it is advisable to connect a ground wire between pin 4 on the Gauger and the GND point of the RS485 adapter.

VI. Firmware upgrade tool

VI.1. Introduction

GaugerGSM/485 firmware can be upgraded in the field. The upgrade procedure takes less than 5 minutes but should be done carefully to avoid damage to the system. This feature is useful for adding new features to your GaugerGSM system and for fixing bugs.

- Perform firmware upgrade only when authorized to do so by the manufacturer or re-seller.
- While upgrading **GaugerGSM/485**, record your steps and also record any messages that appear on-screen. This will aid in troubleshooting a defective upgrade process.
- Most stored settings will usually not be lost when upgrading the firmware.
- Use only the updated firmware provided by the manufacturer or re-seller.

VI.2. You will need

(a) PC with minimum requirements: Windows XP Service Pack 2 or Windows7/16 bit, CD drive USB port and administrator rights. The firmware upgrade tool was also tested on Windows7/32 bit.

(b) Internet access to SolidAT site: <http://www.solidAT.com> (alternatively **GaugerGSM/485** Installation CD).

(c) New **GaugerGSM/485** firmware which is authorized for upgrading your **GaugerGSM/485** (the firmware is downloadable from the web site upon approval from the manufacturer).

VI.3. Installation of Firmware Upgrade Tool and USB driver

(a) Browse to <http://www.solidat.com/software-download.htm> and download “Firmware Upgrade Tool (Win 7)” for Windows 7, or download “Firmware Upgrade Tool” for other Windows operating systems. If you do not have Internet access and you do have an Installation CD, browse the CD to identify the “Firmware Upgrade Tool” and copy it to your PC.

(b) Unzip the downloaded file to a directory in your PC. For Windows 7 - click to execute the application. For other Windows operating systems click and execute Setup.exe and when finished, click on the icon which was created on your desktop.

(c) Install **GaugerGSM/485** USB driver by following instructions in chapter: “USB driver installation on a PC”.

VI.4. Upgrade procedure

- (a) Copy the new **GaugerGSM/485** firmware (e.g. xyz.bin) to a directory of your choice.
- (b) Run Gauger Firmware Upgrade Tool by clicking on the proper desktop icon.
- (c) Wait until the proper COM port is identified (the port connected with **GaugerGSM/485**) then press OK on the pop-up window.

Verify that current firmware version is displayed on the top line.

- (d) Click on the “...” button, browse and select the new firmware (e.g. xyz.bin). When the new name appears on the windows, you can press the “upgrade new firmware” button. Follow the progress and instructions on-screen. After some while, **GaugerGSM/485** display will be turned off – this is normal.

During the upgrade, you will see a progressive bar on the window as follows:

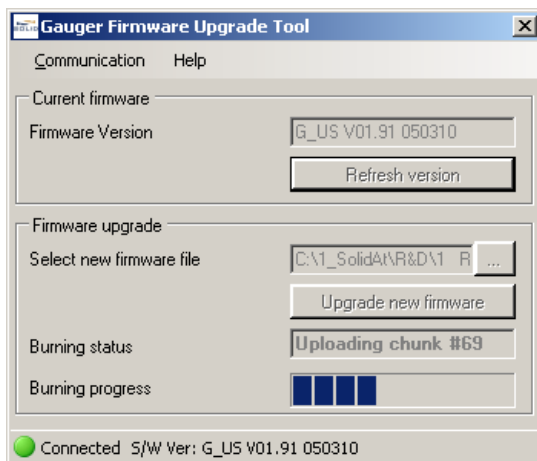

Be patient!

If you do not see the bar starting, or if the bar has stopped moving – just wait! If you disconnect the Gauger while in the middle of the upgrade process, the internal software may be impaired and may require returning to the factory. If the bar has not started or has stopped, wait for at least 10 minutes before reconnecting and restarting the process.

- (e) Wait for the upgrade process to complete.

The process is complete when you see the following window:

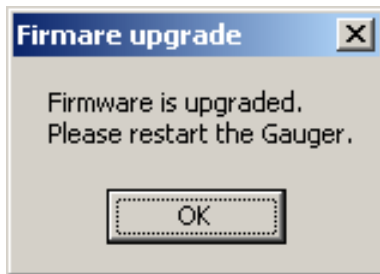

Now click OK and Restart **GaugerGSM/485**.

(f) Close the upgrade Tool by clicking the COMMUNICATION tab and then clicking EXIT.

(g) Reconnect the Gauger to the PC. Turn on HyperTerminal and perform the \$RSD \$ command.

VI.5. Troubleshooting the firmware upgrade process

Symptom	Recommendation
Installing Upgrade Tool	
Installation of the upgrade tool halts due to .NET Framework missing.	Install .NET Framework on you PC (2.0 or above). See http://www.microsoft.com/downloads/details.aspx?familyid=0856each-4362-4b0d-8edd-aab15c5e04f5&displaylang=en
Installation of the upgrade tool halts due to user permissions	Verify that you are a local administrator on the PC.
Upgrading the firmware	
COM port is not found Or current firmware version is not displayed	(1) Make sure GaugerGSM is turned on. Disconnect and then connect again the USB cable. (2) Select the Communication tab. Try automatic port selection then try manual port selection. (3) Shut off the Upgrade Tool then verify with the Windows Task Manager that a Gauger process is not running. Run the Upgrade Tool again.
Upgrade process has halted	Wait for 10 minutes. Restart the application. Restart you PC and try again.
GaugerGSM display stays blank after installation and restart	Restart your PC and try again.

VII. Serial data monitoring

Some variants of GaugerGSM, Gauger485 and Gauger420 may be wired monitored locally through USB and/or RS485 interfaces. This feature is useful for field monitoring and for debugging purposes.

Physical wire connections for USB and RS485 are described in chapter II. RS485 data monitoring settings are: Baud rate: 115200 BPS, 8 bit, no parity, 1 stop bit. Handshake is not supported. When monitoring over RS485 to a PC, a USB/RS485 adapter is required (e.g. VScom USB-COMi).

Data is transmitted as ASCII characters where each measurement is represented by comma separated set-of-fields and terminated with new-line character. Three major field formats are supported: debug message format (USB), long message format (RS485) and short message format (RS485). Details of each format may vary between different firmware versions. In the following message descriptions, NA represents debugging data for the manufacturer.

Typical debug message format (USB):

Index, NA, NA, Level, Distance, NA, NA, Temperature (int), Temperature (ext), NA, NA, NA, NA, Voltage

Typical long message format (RS485):

Index, NA, Distance, Level, Display Value, Temperature (intl), Temperature (ext)

Typical short message format (RS485):

Index, Distance, Level, Display Value, Temperature

In case of doubt, call the manufacturer with a sample of your message format.

Monitoring data over USB or RS485 is enabled with a HyperTerminal command \$ENDT \$ and may be stopped with command \$DSDT \$. For \$DSDT \$ command, it is recommended to use the configuration file method rather than manual commands.

Monitoring data over RS485 in Gauger485 models is enabled by default in some firmware versions. In this case, default message format is a short and \$ENDT \$ will enable the long message format.

If \$ENDT \$ or \$DSDT\$ commands are required, follow the configuration instructions of chapter V. Settings of HyperTerminal for configuring GaugerGSM/485 and for serial monitoring are identical except for the item "Append Line Feed". When monitoring, you should uncheck the "Append Line Feed" item in the ASCII setup to avoid extra lines.

VIII. USB Driver Installation on a PC

This chapter describes the installation of GaugerGSM USB drivers on a PC. The driver installation is required when using the PC / Laptop for:

- Configuration of GaugerGSM/485
- Serial monitoring
- Firmware upgrade

The drivers were tested on XP Windows and Windows 7/32 bit systems and Windows 7/64 bit. The following instructions are valid for Windows XP.

(a) Copy the directory “SolidAT Drivers” from the CD to your PC.

(b) Connect the PC to **GaugerGSM/485** using a USB cable. Keep cable length to less than two meters. Turn **GaugerGSM/485** on (if not already powered by the USB).

(c) Follow the standard driver installation instructions on the PC. Whenever prompted for a driver, select the location of “SolidAT Drivers”.

(d) The following set of windows may aid you when following with the installation.



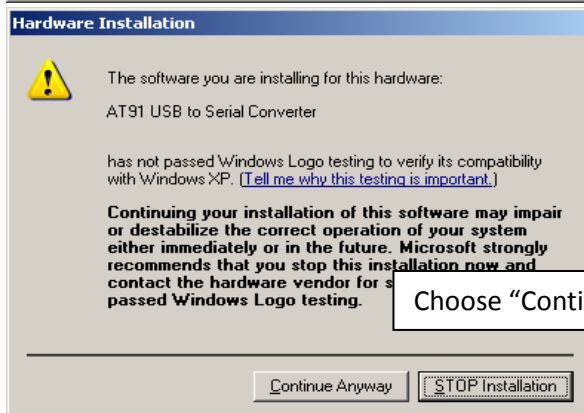
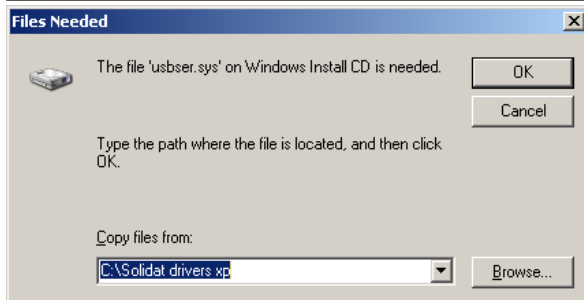
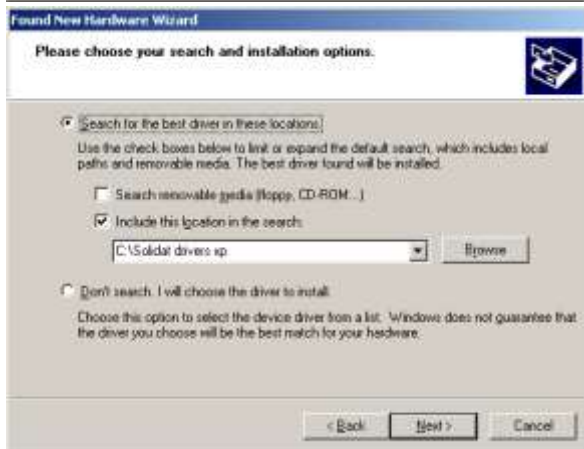



You should also check proper installation by viewing the device manager:

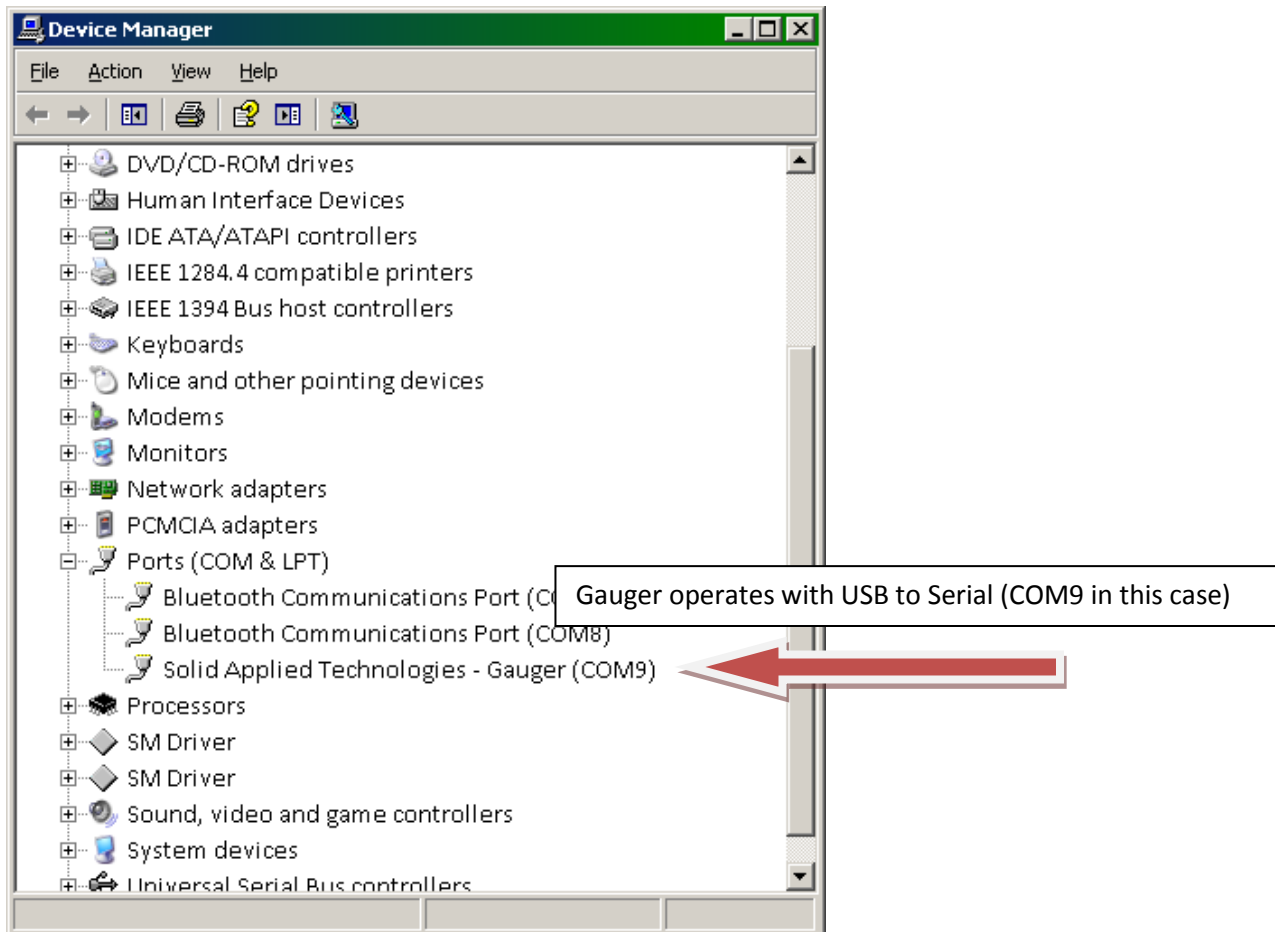

If the USB driver installation failed, a “?” sign may be listed at the “Ports” item. In other cases, the driver may be listed under “Other Devices” item. In both cases, uninstall the device and then re-install it again.

IX. Reference Guide

A

Application dimensions and constraints

(a) Basic dimensions

- Distance
- Level
- Dead zone
- Full level
- Empty level
- Distance to full level (FULL)
- Distance to empty level (EMPTY)
- Maximum range
- Near blocking distance (NBD)
- Far blocking distance (FBD)

These variables are shown on the following figure along with the “**fundamental interdependency equation**”.

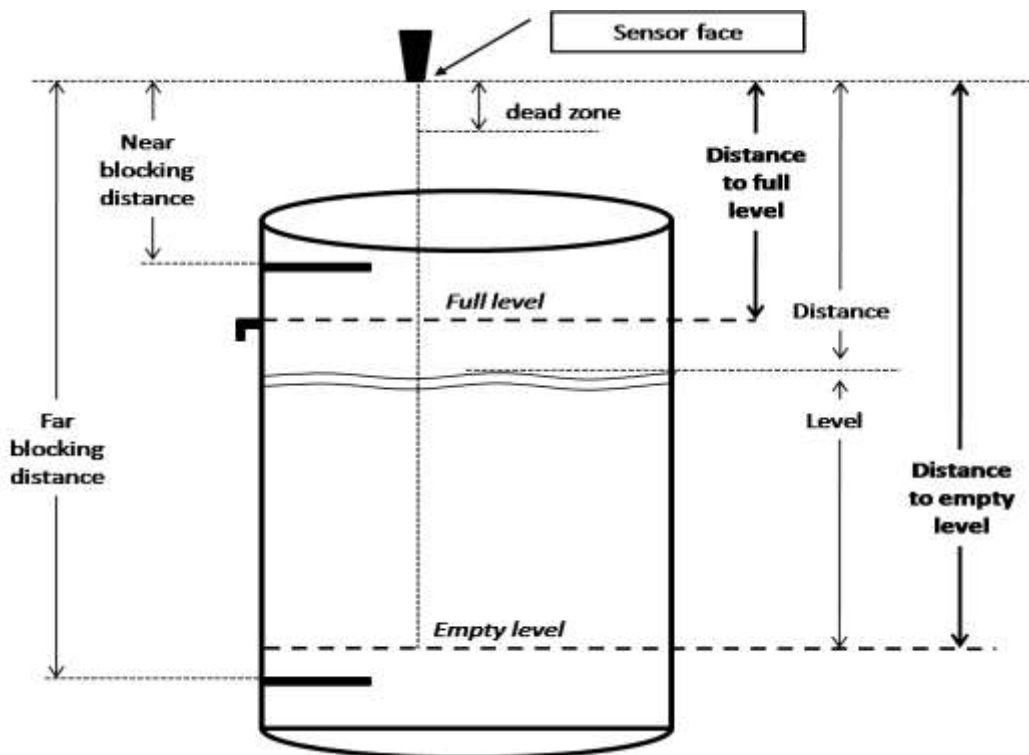

$$15 \text{ cm} = \text{Dead Zone} < \text{NBD} < \text{Full} < \text{Empty} < \text{FBD} < \text{Maximum range} = 8 \text{ meter}$$

Figure 21 - Application dimensions for sensor 75KHz

See also the section: Interdependencies in this chapter.

(b) Distance to empty level

Distance to empty level is defined as the distance from the face of the sensor to the bottom-most surface of the target ever to be measured. For typical installation in tanks, the bottom-most surface is usually the floor of the tank.

GaugerGSM/485-75 supports a maximum range of 8 meters and the default value for distance to empty level is therefore 8 meters. The user is cautioned however that the maximum practical range depends on target characteristics. Range of 8 meters may be achieved with quiet liquid surface targets. As a rule of thumb, use no more than 6 meters for solids, turbulent liquids, when the air medium is not clear or when interferences exist. You may verify proper operation by checking whether the equipment frequently enters a state of “echo search” at your maximum distance.

Similarly, GaugerGSM/485-50 supports a range of 0.35 – 9.50 for liquids and 7 meters for solids.

When GaugerGSM enters the empty level, it will present an empty status on the display. GaugerGSM will then exit this state when level rises at least 2cm above the empty level.

(c) Distance to full level

Distance to full level is defined as the distance from the face of the sensor to the top-most surface of the target to be measured. The default value for distance to full level is 15cm or 35cm. This is also “dead zone” of GaugerGSM/485 and cannot be reduced under any circumstances.

The user is cautioned to prevent targets from crossing this limit as this may result in unpredictable measurements. You can overcome this limitation by proper installation. For example, if the target can approach the tank roof, install GaugerGSM/485 on top of an extension pipe which is at least 15cm long.

When GaugerGSM enters the full level, it will present a full status on the display. GaugerGSM/485 will exit this state when level decreases by at least 2cm below the full level.

(d) Far blocking distance

GaugerGSM/485 normally measures distance to targets which are closer than the “Empty level”.

In some circumstances, GaugerGSM/485 might detect an echo which is further out than the “Empty level”. This echo may be the result of the actual target below the empty level or a strong interference below the empty level. In such cases, GaugerGSM/485 would report “Empty” and would transmit an SMS to report the event. If you expect echoes further out than the empty level, and you prefer to avoid these event reports, you can define a Far Blocking Distance (FBD). Once defined, GaugerGSM will completely disregard any echoes beyond the FBD. If no other echoes closer than FBD are detected, the Gauger will report loss of echo.

The default for “Far Blocking Distance” is identical to the maximum range of GaugerGSM/485.

(e) Near blocking distance

If distance between the sensor face and the topmost level of the target is larger than the specified “dead zone” by at least 5cm, you should consider defining a Near Blocking Distance (NBD). The NBD should be defined as 2-3 cm shorter than the distance to the topmost level. This will ensure that the Gauger will not measure obstructions slightly above the topmost level and mistakenly report them as full level.

Similarly, when an extension pipe is used, and the length of the extension pipe is larger than the “dead zone”, you should define NBD which is larger by 2-3 cm than the length of the extension pipe. This will ensure that you will not pick up echoes arising from the bottom end of the pipe and report them as full level.

If no other echoes further than the NBD are detected, the Gauger will report lost of echo. The default for “near blocking distance” is identical to the “Dead Zone”.

When using an extension pipe, a \$PIPE command may be used to improve results. The PIPE command reduces false echoes originating from multiple extension-pipe reflections.

Application type

Application type allows some tuning of the internal GaugerGSM/485 algorithm to be tuned to the application. The application may be selected as low power or High power. Always use low power for stable measurements unless your target appreciably attenuates the echo such as: powder solids, liquid with foam or long extension pipes.

C

Cellular communication (GaugerGSM only)

GaugerGSM is equipped with an integrated cellular modem allowing periodic reports of measured data and immediate alerts. Alerts include empty and full states and excessive level change rates. Excessive level change rates may indicate theft or tank refilling or an approaching flood. The user can configure the destination phone number, periodic reporting interval, normal level change rates and more. The user can activate or deactivate specific alerts.

The modem is of the quad-band GSM type and cannot be used with other cellular standards. An antenna is connected internally within the **GaugerGSM**. A SIM card must be inserted into **GaugerGSM**. The SIM card must adhere to the instructions provided in the installation chapter. Carefully read and comply with these instructions.

Contact alert (GaugerGSM only)

Contact alert identifies a change of an external On/Off state and transmits an SMS / GPRS alert to report the event. The Contact alert does not affect other SMS / GPRS message types which are initiated by **GaugerGSM**. This feature is applicable for firmware versions 1.94 and above. The On/Off states identified by **GaugerGSM** are OPEN/SHORT between pins 5 and pin 4 (Ground) on **GaugerGSM** connection board.

A change in state is reported only if the new state persists for more than 10 seconds. No SMS is transmitted if the state toggles for less than 10 seconds. A change to OPEN state is reported by a standard SMS message with status field "9" (last field in the SMS message). A change to SHORT state is reported by a standard SMS message with status field "8".

At **GaugerGSM** turn-on, a special message is transmitted to report the initial contact state with "9" designating an OPEN state and "8" designating a SHORT state.

Correction for time of day (GaugerGSM/485 only)

GaugerGSM may be set to correct distance measurement which are correlated to time of day. For example, tank shapes may slightly deform during mid-day when sun is high. This behavior may be corrected and pre-calibrated with the DCOR command. The DCOR command accepts up to four correction points. Each correction point defines an hour and the distance variance (positive or negative) in mm for a related time interval. Correction at other times is interpolated. Correction at a time beyond the 4th point is interpolated with the first point.

D

Default values

Gauger is preset by the manufacturer to a set of default values. The user may revert at any time to these default values by performing the reset-to-default operations as described in the configuration chapters under “Device states”.

Changes to the values made by the user will remain intact (survive equipment on/off) only after the user returns to the measurement screen.

The table below defines the default values. A default value may automatically change in response to a change in some other value. For example, default value of full is 0.15 meter. This value will automatically be changed to 0.5 meter if NBD is set to 0.5 meter. Example for Gauger420: 20mA default value after setup is 7.85 (+/-0.001) meters. This value assumes an empty level at 8.00 meters and a dead zone of 0.15 meter. If empty level is modified to 5 meters and NBD is modified to 1 meter, the 20mA value will automatically change to 4 meters.

Parameter	Default Value GaugerGSM-75	Default Value GaugerGSM-50
Distance Unit	meter	meter
Application	Low power	Low power
Empty level	8.000 meter	9.500 meter
Full level	0.150 meter	0.250 meter
Value to display	Distance	Distance
FBD	8.000 meter	9.500 meter
NBD	0.150 meter	0.250 meter
Filling rate	5 m/min	5 m/min
Temperature units	Celsius	Celsius
Temperature sensor	Internal	Internal
Target cellular number	SolidAT server	SolidAT server
Target cellular number (GaugerGSM)	1800 seconds	1800 seconds
GSM report interval (GaugerGSM)	1	1
Full / Empty activation (GaugerGSM)	0	0
Theft activation (GaugerGSM)	0	0
Refill activation (GaugerGSM)	Level	
4-20 representation (Gauger420)	0 meters	
4mA settings (Gauger420)	7.85 meters	
20mA setting (Gauger420)	15mA	
4-20 fixed current (Gauger420)	0	
HART address (Gauger420)		

Destination phone number (GaugerGSM only)

The SMS destination phone number is a 14 digit number which must be defined in full. Any hyphen signs (“-”) is ignored. Examples:

- A 10 digit phone number 0541234567 may be entered as any of the following:

1	2	3	4	5	6	7	8	9	10	11	12	13	14
-	-	0	5	4	-	1	2	3	4	5	6	7	-
0	5	4	1	2	3	4	5	6	7	-	-	-	-
-	-	-	-	0	5	4	1	2	3	4	5	6	7

- The number *2345 may be entered as any of the following:

1	2	3	4	5	6	7	8	9	10	11	12	13	14
*	2	3	4	5	-	-	-	-	-	-	-	-	-
-	-	-	-	*	-	2	-	3	-	4	-	5	-
-	-	-	-	-	-	*	2	3	4	5	-	-	-

Use country code and an operator prefix as appropriate in your network. It is your responsibility to insert the correct destination phone number as phone number schemes vary world-wide.

Distance units and value to display

Either meter or feet may be selected for the distance unit. This selection defines the complete unit system being used by the Gauger. Selecting meter as your distance unit implies the Metric unit system. Selecting feet as your distance unit implies the Imperial (US / American) unit system. Distance units can only be modified with the PC configuration tool with the command: UNT.

The Gauger built-in display may be configured to display different variables. Distance and level may always be selected as the variable to be displayed. When tank shape and dimensions are defined, the Gauger may also be set to display volume of the target. Volume display may be turned on with the PC configuration tool using the VAL command. Distance or level may be set from the keypad or from the PC configuration tool.

E

Equipment status report (GaugerGSM only)

S1 Value	Description
0	Good measurement and in range
1	Full level
2	Empty level
3	No signal found (performing echo search)
4	Theft indication
5	Tank filling identified
6	Tank filling ended
7	Reserved
8	Contact alert is short (version 1.94 or later)
9	Contact alert is open (version 1.94 or later)
10	Trigger 1 is crossed in upwards direction
11	Trigger 1 is crossed in downwards direction
12	Trigger 2 is crossed in upwards direction
13	Trigger 2 is crossed in downwards direction
14	Trigger 3 is crossed in upwards direction
15	Trigger 3 is crossed in downwards direction
16	Manufacturer use
17	Logger mode
18	Configuration settings (SMS)
19	Relay is set ON
20	Relay is set OFF
21	Temperature threshold crossed down
22	Temperature threshold crossed upwards
23	Voltage threshold crossed down
24	Voltage threshold crossed upwards
25	IO state for GaugerGSM multi IO
26-27-28	Same as above

When both trigger and PTS are enabled (TRGR and LPST commands), the following table applies:

Above...	And below...	S1 value at turn-on
Empty	Empty	2
Empty	Level Trigger 1	8 or 9
Level Trigger 1	Level Trigger 2	10
Level Trigger 2	Level Trigger 3	12
Level Trigger 3	Full	14
Full	Full	1

F

False echo scan by PC

False echo scan by PC is a procedure for identifying and extracting fixed obstructions that may mask proper measurement. Perform a false echo scan when obstructions are nearby the target or sensor. Preferably, false echo scan should be performed when the tank is empty.

Follow these steps:

- (1) Install the Gauger at its intended location. Perform command RSD (RSD does not erase existing FES results).
- (2) Perform command FES and wait for a few seconds. HyperTerminal should display a list of echoes. Each echo is presented by one line, displaying its distance and status. Status may be 0 or 1. "0" refers to a legitimate echo and "1" refers to a false echo.
- (3) Select an echo that represents an obstruction. Find the index of this echo by counting the list of echo lines. The index of the echo on the first line is 1, the index of the echo on the second line is 2 and so on. Perform the command FES X where X is the index.
- (4) Perform the USB command RST.
- (5) Repeat steps (2) through (4) if necessary to define false echoes.

By the end of this procedure, the Gauger should ignore echoes which were defined as false.

Filling Rate

Filling rate allows you to tune the tracking of Gauger to fast moving targets. You should increase the filling rate figure if your target fills up or drains down rapidly. Always use the lowest possible filling rate in order to preserve accuracy of the measurement. A high filling rate will allow better tracking before lost of echo when the target moves rapidly. Nearby full (empty) levels, the tracking rate is reduced to avoid erratic entry into full (empty) level.

Full and empty alerts (GaugerGSM only)

You may activate or deactivate Full / Empty alerts. These alerts co-exist with periodic alerts.

G

Gas Velocity Coefficient

Distance and level are derived by multiplying the delay of ultrasonic echo by the velocity of the ultrasonic pulse in air (close to speed-of-sound). In a gas environment which different than air, the velocity of the ultrasonic pulse is also different.

If velocity in the gas environment is twice as high as the velocity in air, a Gas Velocity Coefficient of 2.0 should be configured within the Gauger using the GCOF command. Similarly, if the velocity in the gas environment is half the velocity in air, the GCOF coefficient is 0.5. Speed of sound at different gasses and mixtures can easily be found in physical and engineering textbooks and internet sites.

GaugerBUS (GaugerGSM/485 only)

GaugerBUS is a physical interface and communication protocol between one Gauger system acting as a master and up to three Gauger systems acting as slaved units. GaugerBUS enables several Gauger485 systems to connect to one GaugerGSM system which acts as a transmitter for data collected from Gauger485 systems.

The USB command MBS defines which system is the master and which is a slaved unit. It further defines the total number of slaved units and the device number for each slaved unit. The command can also select the type of measured data to be transmitted by the master device (distance or level or volume or flow).

The master unit transmits slaved units data and also prints this data via the USB interface (every tenth record).

GPRS architecture (GaugerGSM only)

GaugerGSM can be configured to transmit GPRS messages or SMS messages. A PC configuration command (DATA) selects GPRS or SMS. If GPRS is selected, another command (GPRS) configures GaugerGSM to operate with the GPRS network. The GPRS communication architecture is described in the following figure which also defines the GPRS parameters.

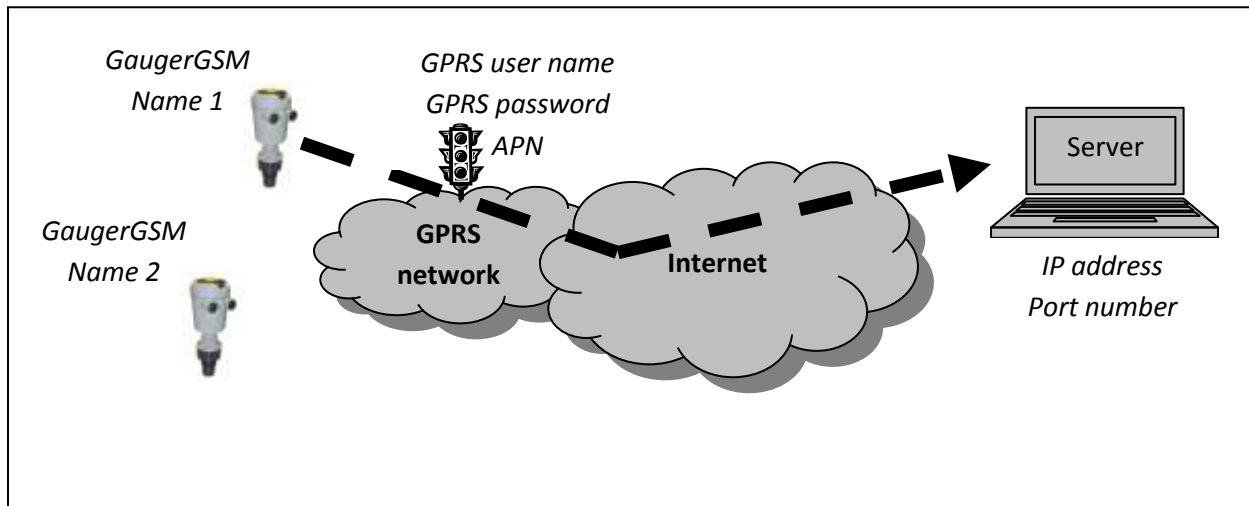

Figure 22 - GPRS communication architecture

GaugerGSM name is a friendly name selected by the users for each Gauger. The selection should be unique for each system unless these two systems communicate with different servers. The name is limited to 30 characters.

GPRS user name, password and APN are parameters provided by the cellular operator and required for any system communicating over GPRS network. “Server name / IP address” and “port number” are entities characterizing the server. The server may be a web server or some other application server provided by third parties. When using the manufacturer GaugerNET server, IP address and port number are provided by the manufacturer.

GaugerGSM transmits two message types:

- Periodic
- Alerts

For each message, GaugerGSM acts as a TCP client and opens a TCP socket session to the Server. The Gauger then sends a message and may or may not disconnect the socket session. Failed connections force retries. The number of retries depends on the importance of the message (e.g. periodic message is less important than an alert message).

Periodic and Alert messages are similar to SMS messages except that the GaugerGSM name is appended as the first field in the message. See section: “GPRS message format”.

GPRS Message Format (GaugerGSM only)

GPRS data is transmitted as textual ASCII messages. The message consists of several data fields separated by a comma. Several formats are available, depending on GaugerGSM configuration. For each format, the interpretation of the fields is fixed.

The following table defines fields which recur in all or most of the message formats:

Field	Description	Format	Units
N	Friendly name	<30 characters	
D	Measured distance	xx.xxx	Meter or feet
L	Measured Level	xx.xxx	Meter or feet
F if flow is set	Measured flow	xxxxxx.x	M ³ /hour
F if S1 = 5	Refill start	xx.xxx or xxxxxx.x	Distance or Volume
F if S1 = 6	Refill quantity	xx.xxx or xxxxxx.x	Distance or Volume
V	Measured Volume	xxxxxx.x	Liters or Gallons
T1	Internal temperature	xx.x	Celsius or Fahrenheit
T2	External temperature	xx.x	Celsius or Fahrenheit
Vin	Voltage In	xx.x	Volt
RSSI	Cellular signal strength	xx	From 2-Low to 32-High
S1	Equipment status(*)	xx	Digits

(*) For S1 options, see the section in this chapter: "Equipment status report".

(a) Format for DATA 1

GPRS messages format when \$DATA 1\$ is configured are in the form:

"N, D, L, F, V, T1, T2, S1"

(b) Format for DATA 3

GPRS messages format when \$DATA 3\$ is configured are in the form:

"N, D, L, F, V, T1, T2, Vin, RSSI, S1"

(c) Format for DATA 4

GPRS messages format when \$DATA 4\$ is configured are in the form:

"N, D, L, F, V, T1, T2, Vin, RSSI, S1, DAT, TIM"

In this message, DAT and TIM are as defined below:

Field	Description	Format	Units
DAT	Date timestamp	"yy/mm/dd	"Year/Month/Day
TIM	Time timestamp	hh:mm:ss"	Hour:Minute:Second"

Note that DATA 4 requires setting of the self SIM number using the STEL command.

(d) Format for GaugerGPS

“N, D, L, F, V, T1, T2, Vin, RSSI, S1, \$GPGLL, LAT, N/S, LON, E/W, NA, NA, NA”

In this message the following fields are included:

Field	Description	Format	Units
LAT	Geodesic Latitude	xxxx.xxxxxx	Deg*100+minutes
N/S	Latitude North or South		
LON	Geodesic Longitude	xxxx.xxxxxx	Deg*100+minutes
E/W	Longitude East or West		

(e) Format for GaugerGSM logger messages

Logger messages (low power mode with PTS) are in the form:

“N, TI, XID, <Tave>, I₁, X₁, I₂, X₂, I₃, X₃,...,RSSI, Vin, 98”

During logger operation, two elements of information are logged within the Gauger. One element is always Level and the second element is configurable and depends on the VAL settings. Logger messages transmit the series of logged elements along with some averaged data over all wakeups.

In this message the following fields are included:

Field	Description	Format	Units
TI	Time interval for logger	xxx	Minutes
XID	Identity of 2 nd logged data element	1: level 2: distance 3: volume 4-6: flow/refill 70-74: flow/refill 8: %flow 9: totalization	
<Tave>	Average temperature	xx.x	Celsius or Fahrenheit
I _k	Level during wakeup k	xx.xxx	Meter or feet
X _k	2 nd logged data during wakeup k	xx.xxx	As defined by XID

GSM display status reports (GaugerGSM only)

The following status reports may be displayed on the display:

Error indications	Proper operation
GSM REGISTRATION FAIL	GSM NOT ACTIVE (temporary)
GSM MODEM NOT READY	GSM INITIALIZING
GSM TRANSMISSION FAIL	GSM REGISTRATION SENT
GSM SIM FAIL	GSM PERIODIC ACTIVE (*)
GSM NOT ACTIVE (fixed)	GSM DESTINATION ASSIGNED
	GSM SMS SENT
	GSM EVENTS ONLY
	GSM_MSG_LOGGED #

In addition, when GPRS is active, the following messages may be displayed:

Error indications	Proper operation
UNKNOWN	GPRS INITIALIZING
OPERATION FAILED	GPRS MSG SENDING
OPERATION TEMPORARILY NOT ALLOWED	GPRS PERIODIC ACTIVE (*)
OPERATION NOT ALLOWED	GPRS RESTARTING
NETWORK IS DOWN	GSM_MSG_LOGGED #

(*) GSM/GPRS PERIODIC ACTIVE may also appear if GaugerGSM cannot transmit a message after one minute of repeated trials.

For SMS messages, the following sequence of status reports is as follows:

When GaugerGSM is turned ON, it first searches for a proper level target. Once found, GaugerGSM begins to seek for a GSM network. A status report GSM INITIALIZING will be displayed at this time. The search for GSM network may take between 10 seconds and up to a minute.

If GaugerGSM fails to locate a GSM network, one of the error indications will be displayed. When such an error is displayed, verify by using a cell-phone that the area is indeed covered by a GSM network and that the SIM card you inserted into GaugerGSM is good. Let GaugerGSM do some retries for 30 seconds and then turn GaugerGSM OFF and then ON again to try again.

If GaugerGSM successfully locates a GSM network, the status report GSM PERIODIC ACTIVE will be displayed. When an SMS is transmitted, a sequence of status reports will be displayed: GSM DESTINATION ASSIGNED, GSM SMS SENT and GSM PERIODIC ACTIVE. GSM PERIODIC ACTIVE may also appear if GaugerGSM fails to send a message after repeated trials for over one minute. GSM EVENTS ONLY report is displayed if the user disabled periodic SMS reports. Disabling the periodic SMS report is

performed by entering 0 (zero) at the report interval, either manually or by using the PC configuration command SMST. For GPRS messages, the following sequence of status reports is as follows:

When GaugerGSM is first turned on, a “GPRS INITIALIZING” report is displayed. If no GSM network is available or if the network is available but GPRS services are not supported, one of the error messages will be displayed. If the GPRS service is available, the report: “GPRS PERIODIC ACTIVE” will be displayed. GPRS PERIODIC ACTIVE may also appear if GaugerGSM does not succeed in sending messages for repeated trials lasting more than a minute. When a GPRS message is transmitted, the status report “GPRS MSG SENDING” is displayed. If the message transmission fails, one of the error messages will be displayed.

GSM/GPRS MESSAGE LOGGED # is presented when GaugerGSM operates in log mode and # presents the index number of the logged message.

GSM reporting interval (GaugerGSM only)

You can determine the periodic reporting interval using one of the configuration methods. The interval is defined in seconds. For example, for an SMS report once every hour, modify the interval to 3600. Report interval lower than 60 (older versions: 180) seconds are not accepted and will revert to 180 seconds. Maximum report interval is 3,999,999 seconds which comes up to about 45 days. A reporting interval of 0 (zero) disables the periodic reports.

H

HART communications (Gauger420 with HART option only)

HART is a standard digital communication protocol carried by the two power lines of **Gauger420**. When using HART communications make sure that the voltage on Gauger420 port is at least 14VDC. In addition, the loop current should not be lower than 7mA. The protocol can provide information on four different measurands which may be selected at setup. HART may be used as a bus protocol allowing up to 16 devices on the same bus, each identified by a unique address.

HART parameters may be set using the PC configuration option. The setup provides for:

- Determining the four measurands (PV, SV, QV and TV)
- Determining the **Gauger420** address

Some notes related to HART configuration.

- Support for HART depended on firmware version.
- PV is automatically mapped to the process defined by 4-20. If current is fixed, PV can be set by HART command.
- Guidelines related to the configuration of PV, SV, TV and QV using the PC:
 - (1) Value 3 is Temperature as defined in SNS and may not be used by PV.
 - (2) Values 2 and 6 may be selected only if VAL=3 or 6.
 - (3) Each of PV, SV, TV and QV must be unique.
- HART should be configured after configuring all other settings. IF EMP or FUL are modified then HART configuration will be reset to the default values. Default values are defined at the EMP and FUL levels.

Gauger420 with HART option supports HART Universal commands:

0,1,2,3,6,7,8,9,11,12,13,14,15,16,17,18,19,20,21,22.

Gauger420 with HART option also supports selected Practice commands:

36, 37, 38, 40, 42.

Gauger420 is compatible with HART Communicator Model 375 revision 6. The following parameters have been verified: PV (measurement and unit), Current (in mA), LRV (read and set), URV (read and set), Percentage-Current, TAG 8 (read and set), LSL and USL.

/

Interdependencies

For Metric units of GaugerGSM/485-75

	Applicable to items	Interdependencies
1	EMP, FUL, NBD, FBD	$0.15 \leq \text{NBD} \leq \text{FUL} \leq \text{EMP} \leq \text{FBD} \leq 8.000$
2	TWOW Gauger420 only	<p><i>When representing Level:</i> $0 \leq \text{Level represented by 4mA} \leq \text{Level represented by 20mA} \leq (\text{EMP-FUL})$</p> <p><i>When representing Distance (reverse Level):</i> $\text{FUL} \leq \text{Distance represented by 4mA} \leq \text{Distance represented by 20mA} \leq \text{EMP}$</p> <p><i>When representing Volume:</i> $0 \leq \text{Volume represented by 4mA} \leq \text{Volume represented by 20mA} \leq$ Volume at level of (EMP-FUL)</p>

For American units

	Applicable to items	Interdependencies
1	EMP, FUL, NBD, FBD	$0.50 \leq \text{NBD} \leq \text{FUL} \leq \text{EMP} \leq \text{FBD} \leq 26.00$
2	TWOW Gauger420 only	<p><i>When representing Level:</i> $0 \leq \text{Level represented by 4mA} \leq \text{Level represented by 20mA} \leq (\text{EMP-FUL})$</p> <p><i>When representing Distance (reverse Level):</i> $\text{FUL} \leq \text{Distance represented by 4mA} \leq \text{Distance represented by 20mA} \leq \text{EMP}$</p> <p><i>When representing Volume:</i> $0 \leq \text{Volume represented by 4mA} \leq \text{Volume represented by 20mA} \leq$ Volume at level of (EMP-FUL)</p>

Similar interdependencies apply to GaugerGSM in accordance with the specification limits.

L

Logger Operation (GaugerGSM only)

Logger operation can be activated if PTS is active at all zones (\$PTS 1\$) or in some zones (\$PTS 0\$). GaugerGSM logger operation allows limited storage of measurement points before transmission of a GSM burst. Logger operation requires use of PTS. Two measurements elements are logged at each wakeup and transmitted in a later burst. One element is level and the other element is the measurement variable as defined in the \$VAL command (value to display). See GPRS Message Format Section (or SMS Message Format Section) for message structure details.

Logger operation is defined by two commands: LPST and DLOG (see details of each command in chapter V section V.5.2). When logger operation is turned on, GaugerGSM is awakened by the PTS following a sleeping time as defined for each zone by the DLOG command. The Gauger takes a measurement, stores it locally and “goes-to-sleep” again. The DLOG command also defines a logger depth for each zone. Once the number of stored measurement points reaches logger depth, a message is transmitted (GPRS or SMS) with all stored data. A message is also transmitted at wake up time, if a zone is crossed. In the latter case, the last measurement (belonging to the new zone) is also transmitted.

If GaugerGSM burst transmission cannot be accomplished, the Gauger will re-attempt transmissions for some time. In this case, a new measurement will be added to the storage, while deleting the earliest measurement point if logger is full. Logger data may be lost if logger is disabled or RSD command is executed.

Example

\$EMP 2.5 \$

- Empty level is at a distance of 2.5 meters from sensor face

\$LPST 2, 1.5, 2, 1, 1, 2 \$

- Lower zone is defined from distance of 2.5 meter (EMP) to 1.5 meter from the sensor face
- Mid zone is defined from a distance of 1.5 meters up to a distance of 1 meter from sensor face
- Upper zone is defined from 1 meter up to FUL (or up to NBD or up to dead zone).
- Time intervals are ignored if last parameter is higher than 1, indicating DLOG command is in-effect.

\$DLOG 30, 15, 12, 45, 5, 1\$

- Sleep interval is 30 minutes at the lower zone and logger depth is 15 points
- Sleep interval is 12 minutes at the mid zone and logger depth is 45 points
- Sleep interval is 5 minutes at the upper zone and logger depth is 1 point

Assume measured level is at the lower zone (distance to sensor face between 2.5 meter and 1.5 meter). GaugerGSM will wake up after 30 minutes, measure distance, store it and go to sleep again. After 15

such cycles ($15 \times 30 = 450$ minutes), GaugerGSM will transmit a burst data with 15 level + 2nd element measurement points.

If, for example, after the 14th measurement level increases to 0.7 meter from sensor face, Gauger will send the partial logger data stored up to that time. Once transmission is successful, data will be deleted from the storage and logging will initiate at the next wakeup time which is 5 minute later.

Note: Configuration over the air (OTA) is possible when the Gauger is operating in a PTS mode (sleeping intervals) and also in a logger mode. The Gauger will read configuration commands during normal message transmission. For example, in a logger operation of one burst transmission per 8 hours, the command may be performed up to 8 hours after command was sent to the Gauger. This feature also depends on local cellular network support.

M

Mapping Table

A mapping table can be defined for mapping between:

- Level and corresponding flow in Open Channel Flow applications
- Level and corresponding volume in tank related applications

In both cases, a mapping table is defined using the TBL command. The table is interpreted as volume if TVOL command is performed or interpreted as flow if OCF 99 command is performed.

Up to 32 entries may be defined within the table. The Gauger measures level and calculates volume or flow by interpolation between two corresponding table entries. Level units are either cm or inches depending on the chosen unit system.

A typical series of commands to enable table based Open Channel Flow is as follows:

\$TBL 1, 4, 234.4 \$.....Define first entry in table (level = 4 corresponds to flow 234.4)

\$TBL 2, 25, 434.0 \$.....Define second entry in table

\$TBL 3, 90, 1057 \$.....Define third entry in table

...

\$TBL 15, 150, 2560.4 \$.....Define entry #15 in table

\$TBL 16, 155, 2600.0 \$.....Define entry #16 in table

\$STBL\$.....Show all table entries on the HyperTerminal

\$OCF 99, 0, 15, 3\$.....Enable Table based Open Channel Flow.

Level table entries are in metric units (cm).

Flow units are in Liter/sec.

Use only entries 1-15 (entry 16 is ignored).

\$VAL 7\$.....Show flow on display

0

Open Channel Flow

Open Channel Flow refers to the flow of water or wastewater in natural channels such as rivers or in artificial channels such as irrigation ditches. Under some conditions, fluid level in the channel (in units of meters or feet) can be mapped to flow (in units of cubic meter per hour, gallons per minute etc).

Typically, flumes or weirs are constructed in the channel to allow calculation of flow from level. Flumes and weirs are structures that introduce a well-designed obstacle to the fluid flow causing a measureable increase in the fluid level nearby the obstacle. This level increase can be measured to obtain flow using hydrological formulas or empirical equations.

Several different designs of flumes and weirs are applied world-wide. GaugerGSM implements flow equations for nine different designs:

- **Rectangular suppressed sharp crested weir**

This entry defines a rectangular, suppressed, sharp crested weir. The width of the opening should be defined. Limits are 20-300 cm or 12-96 inches. Sharp crest refers to the thickness of the weir as explained in the following figure.



Figure 23 - Side view of Sharp crest (left) and broad crest (right)

- **Rectangular contracted sharp crested weir**

This entry is similar to the suppressed weir but the opening is constrained in the width dimension. The width of the opening should be defined. Limits are 20-300 cm or 12-96 inches.

- **Trapezoidal (Cipolletti) sharp crested weir**

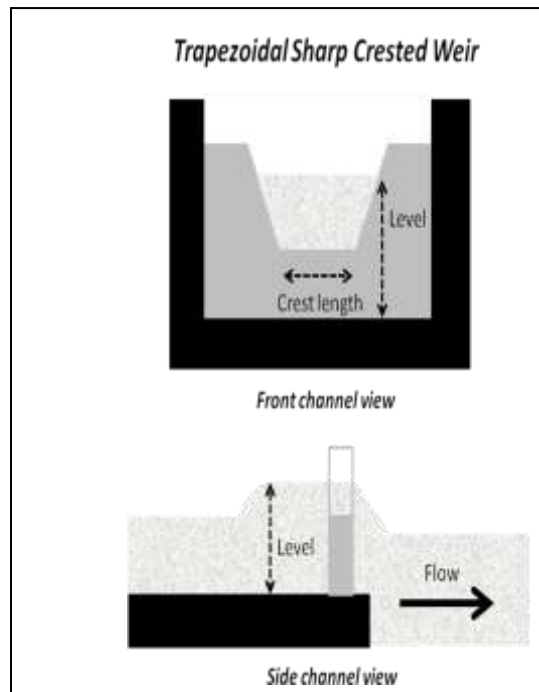

Figure 24 - Trapezoidal sharp crested weir

- **V-Notch (Triangular) sharp crested weir**

This entry defines a V-Notch (Triangular) sharp crested weir. The V-notch angle must be defined. Limits are between 22.5° and 90°.

- **Parshall Flume**

This entry defines a Parshall flume. Throat width must be defined. Limits are 15 - 360 cm or 6 - 144 inches.

- **Palmer-Bowlus Flume**

This entry defines a Palmar Bowlus flume. Conduit diameter must be defined. Limits are 15 - 75 cm or 6-72 inches.

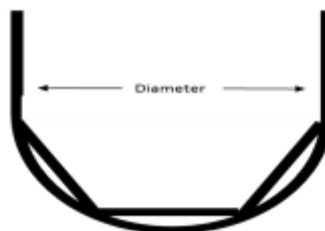

Figure 25 - Front view of Palmar Bowlus flume

- **H-Flume**

This entry defines an H-Flume structure. Width of the flume must be defined. Limits are 15 - 135 cm or 6-54 inches.

- **Khafagi-Venturi Flume**

This entry defines a Khafagi Venturi flume. Width of the throat must be defined. Limits are 12 - 160 cm.

- **Leopold-Lagco Flume**

This entry defines a Leopold Lagco flume. Diameter of the external pipe must be defined. Limits are 4-72 inches.

For each design GaugerGSM supports a range of sizes which usually represent the obstacle size within the structure (crest length in weirs or flume throats). These sizes can be defined in either cm or inches.

The calculated flow may be obtained in one of the flowing units:

1. Cubic meter per hour (M3H)
2. Cubic feet per second (CFS)
3. Gallons per minute (GPM)
4. Liter per second (LPS)
5. Million Gallons per day (MGD)

Additional flume and weirs as well as additional flow units may be added to GaugerGSM upon request.

When no flume or weirs are present within the channel, the Manning Formula may be applied: http://en.wikipedia.org/wiki/Manning_formula. With this formula, flow may be calculated if certain characteristics of the channel are known. Specifically, channel cross section shape and size, channel slope along the flow and roughness coefficient. GaugerGSM implements the Manning Formula for channels in the shape of pipes (e.g. semicircular cross section).

- **Circular Manning**

This entry defines the parameters of a generic pipe with circular cross section. Flow is calculated using Manning formula for gravitational flow. The diameter of the pipe, roughness coefficient of the pipe walls, and forward slope of the pipe must be defined. The diameter is set in cm or inch units and limits are 15 – 900 cm or 6-350 inches. Slope may be above 0.0 and up to 1.0 (45°). Typical sewer line slopes are 0.01. Roughness coefficient limits are above 0.0 and up to 0.2. Typical roughness coefficient for cement pipes is 0.013. Use on-line engineering tables to estimate roughness coefficient of other materials.

GaugerGSM is setup for a specific flume, weir or Manning circular pipe by using a USB command and in some cases configuration by menu. See chapter “Configuration with a PC”.

P

PTS configuration for battery operation (GaugerGSM only)

The Programmable Timer Switch (PTS) is an external device for enabling low power mode of GaugerGSM. This low power mode is required for battery based operations.

The PTS turns GaugerGSM/485 ON to take a measurement and, in some cases, to transmit the measured information. Then the PTS turns GaugerGSM/485 OFF for another sleeping period. GaugerGSM is then turned ON again and so on. With this method, a 20AH/12V battery can typically feed GaugerGSM for 1-3 years before replacement is needed.

Two different sleeping intervals may be programmed by the user: long interval and short interval. The sleeping interval in-effect depends on the level being measured. For example, assume that a river overflows at a level of 2.0 meters and calm waters are defined at a level of 1.0 meter. A very long sleeping interval (e.g. 6 hours) can be set for level measurement between 0 meters and 1.0 meters. A shorter interval of 30 minutes can be set for levels between 1.0 meters and 1.8 meters.

Finally, above 1.8 meters the PTS may be disabled and GaugerGSM/485 will operate continuously and transmit messages as defined for continuous operation. When operating continuously, the period between messages is defined by the GSM reporting interval parameter (SMST). In some firmware versions, the Gauger may be turned off also at the high level and turned on again after period of SMST. This mode is controlled by the command PTS=0. If PTS=1 or 2, The Gauger will measure continuously and transmit a message once per SMST.

This three phase concept is further described in the following figure.

Vessel	Predefined levels	Standby modes
	Full Level	Continuous measurement or sleep interval of SMST
	High Level	Short sleep intervals
	Low Level	Long sleep intervals
	Empty Level	

Figure 26 - Low power predefined levels

When the low-power mode is active (during short or long sleep intervals), message may be transmitted at each wake up. Alternatively, a burst message may be transmitted once in a few sleeping intervals. The

burst message will contain a set of data messages taken from each wakeup. This mode of operation allows logging of messages. Up to 20 messages may be logged (SMS) or 100 messages (GPRS).

PTS parameters are defined by the command LPST as described in the chapter “Configuration with a PC”. Both sleep intervals cannot be shorter than 2 minutes and preferably be longer than 10 minutes.

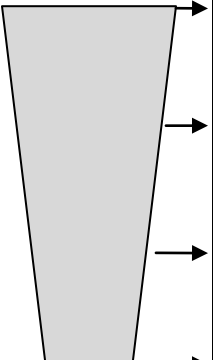
The last parameter in the LPST command may be “0” – disabling any messages during the long sleep interval. The parameter may be “1” allowing a message at each turn on. The parameter may also be a number between 2 and 20, allowing logging of several messages prior to transmission.

When this parameter is larger than 1, the message format (both SMS and GPRS) changes to accommodate for the data set. See section SMS format and section GPRS message format.

As a precaution, the PTS is set to shut down the Gauger by force if the Gauger is not communicating with the PTS. Shut down is inflicted after 2 minutes (SMS) or 4 minutes (GPRS).

Do not configure GaugerGSM/485 while the system is connected to a battery through the PTS. A shutdown may be forced by the PTS causing loss of data.

When using EX-rated PTS and battery pack the special instructions described in the Installation chapter must be closely followed.

R

Refill alerts (GaugerGSM/485 only)

When Refill alerts are activated, GaugerGSM/485 identifies a refilling process. GaugerGSM transmits an SMS soon after the refilling is identified and a second SMS soon after the refilling process has ended.

The first SMS provides distance information (distance between sensor and fuel surface). The second SMS provides information about the filling quantity. This procedure allows more accurate refilling information when compared with the information that can be extracted from periodic reports.

Relay Device

Gauger models which are equipped with RS485 output can control external devices including external relay sets. The ERLY command is tailored to control an external 8-channel relay device by KMTronic:

<http://sigma-shop.com/product/103/rs485-8-channel-relay-controller-12vdc.html>.

The command predefines a value for each of the eight relays. The relay will turn ON if measured value is above the predefined value. The value refers to whatever measurement is selected with VAL command (which is also the value displayed). A predefined value of “-1” will deactivate that relay. Both relay logics (NO/NC) are available on the KMTronic device.

Relay Truth Table (GaugerGSM/485 only)

Some Gauger models support relay operation. Relay A operation is defined by USB command RLY and Relay B operation is complementary to Relay A. When Relay A is Short, Relay B is Open and vice versa.

Electrical connections are described in the Physical and Electrical Installation Guideline Chapter.

The RLY command is defined in the list of commands for configuration from a PC section and consists of four configuration parameters:

- Mode (0,1,2)
- Value (numerical value)
- Direction (0,1)
- Hysteresis (numerical value)

The following truth table summarizes options.

Mode	Value	Direction	Hysteresis	Theft	Previous	New relay state
0	x	x	x	x	x	Open
1	v	1	h	x	x	IF(reading > v) then close
1	v	1	h	x	short	IF(reading > v-h) then open
1	v	0	h	x	x	IF(reading > v) then open
1	v	0	h	x	open	IF(reading < v-h) then close
2	x	1	x	No	x	open
2	x	1	x	Yes	x	close
2	x	0	x	No	x	close
2	x	0	x	Yes	x	Open

X designates “not important” in this table.

Reset and operating hours

GaugerGSM/485 may be reset to their factory defaults. This operation may be performed from the keypad or from the PC configuration tool (command RSD). Once executed, the Gauger will return to the state as delivered from the factory. GaugerGSM/485 may also be reset to restart without any change in the pre-configured parameters (command RST).

GaugerGSM/485 keeps track of two counters for measuring operating hours.

- Non resettable counter (Odometer principle)
- Resettable counter (Trip-meter principle)

The non-resettable counter displays the total hours of operation since the system is out of the factory. This counter aids both manufacturer and user in keeping track of specific GaugerGSM/485 history. The resettable counter displays the total hours of operation since last reset of this counter. This counter aids the user in keeping track of the equipment for maintenance and other operations. The resettable counter may be activated from the built-in display or using the PC command RSC.

S

SMS format (GaugerGSM only)

See section GPRS Format (for GaugerGSM). The NAME (“N”) is not included in SMS messages. Not all GPRS options are implemented with SMS. Check with the manufacturer.

T

Temperature Coefficient of Expansion

Liquids expand when temperature rises. Measured volume will therefore increase when heated. Gauger systems can compensate for this effect by re-calculating volume to a fixed reference temperature. Example: Assume the fixed reference temperature is set to 23°C and measurement takes place at 35°C showing volume of 900 L. Also assume that temperature coefficient of volume expansion for this liquid is 750ppm/°C. The recalculated volume for 23°C will be: $900 / [1 + (35-23)*0.00075] = 892 \text{ L}$.

Activating the USB command TCOF enables re-calculation of volume to a reference temperature. Two parameters are defined by the user: reference temperature and temperature coefficient of volume expansion for the liquid. Re-calculation affects volume measurement but not level or distance.

Temperature sensors, units and temperature display

Gauger systems implement automatic compensation of deviations due to temperature variations in the air temperature of the ultrasonic media. The temperature is sensed by a temperature sensor which is embedded within the acoustic sensor. In installations where temperature varies very rapidly in time and location, it may be preferable to install an external temperature sensor (GaugerGSM) which will follow more closely the varying temperature.

For these installations you can select the internal embedded temperature sensor or the external temperature sensor (if one is connected) or average both readings. Physical connection and installation of the external temperature sensor is described in the chapter physical installation guidelines. Temperature units may either be selected as Celsius or Fahrenheit. Temperature may be viewed on the built-in display. Temperature readings on the display present the following table:

Sens:	Cur	High	Low
Int	29.5	31.0	26
Ext	29.4	32	23.3

Reset Done

Figure 27 - Temperature readings

The second line displays temperature measured by the internal temperature sensor. The third line displays temperature measured by the external temperature sensor. The column “Cur” displays the current temperature while “High” and “Low” columns display the highest and lowest temperature ever recorded by the temperature sensors since the last reset was performed.

Test Mode during installation (GaugerGSM/485 only)

GaugerGSM functionality can be monitored by cable (USB / RS485) during installation. See chapter “Serial Data Monitoring” for additional details. In sites where cable monitoring is not practical, the installer must rely on SMS / GPRS messages. These messages include important information such as RSSI (cellular Received Signal Strength Indication). When message interval is set to long duration such as several hours, it may not be practical to wait at the site for this long period of time. In these cases, the installer can use the TEST command to quickly send up to five messages from equipment turn-on. Additional information about TEST command can be found in the chapter “Configuration By PC”.

Theft alerts (GaugerGSM/485 only)

GaugerGSM/485 supports theft detection alerts by examining rate of liquid consumption. Determine the rate which would be considered as inappropriate in units of level per minute (e.g. mm/min) or volume per minute (e.g. liter/min) and modify the deviation number accordingly. Limits are defined in the chapter: “Configuration with PC”. Rates lower than 4mm/min may cause excessive false alerts. Entries lower than 4mm/min will automatically be converted to 4mm/min. It is recommended to experiment with the specific tank and environment with this figure until no false alarms are transmitted.

Alert SMS or GPRS will be transmitted within a minute following detection of an inappropriate consumption rate. Alert SMS / GPRS will be sent once a minute as long as the excessive consumption rate is detected. This may aid the user in determining the duration and persistence of the implied theft.

Theft alerts co-exist with periodic alerts and with Full and Empty alerts.

Trigger alerts (GaugerGSM/485 only)

GaugerGSM/485 supports up to three distance-triggered alerts. Each alert is characterized by two parameters:

- (a) The percentage of distance that will trigger the alert. For example, 25% will trigger an alert when target distance from the sensor is $\frac{1}{4}$ distance to empty level.
- (b) The direction, when crossing the predefined distance, which will initiate an alert. The direction may downwards (tank is being filled) or upwards (tank is being emptied) or both directions.

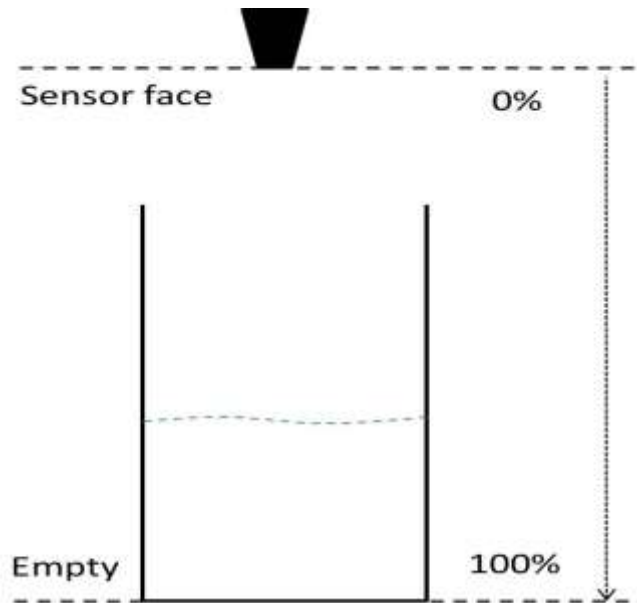

Figure 28 - Trigger definition in percentage

When more than one trigger point is defined, a gap of at least 2 percent points must be kept between any two triggers. GaugerGSM/485 automatically spreads trigger points that are too close to each other. For example, trigger points defined as 30%, 31% and 32% will be spread out as 30%, 32% and 34%. In this case, a warning is sent to the configuring PC.

GaugerGSM/485 avoids excess messages in the event of large target ripples in the vicinity of the trigger point by implementing a hysteresis algorithm. In addition, messages of any type may only be transmitted if three minutes have passed since the previous message. If two trigger levels are crossed in less than three minutes, an alert will not be sent from the first trigger level.

When the Gauger is just turned on and if trigger alerts are defined, the downward alert will be sent. When operating with the PTS which enforces a Gauger ON/OFF operation, only downwards alerts are sent. Trigger alerts co-exist with periodic alerts and with Full and Empty alerts. When using PTS with

LPST and TRGR, the status field is defined by the TRGR command. If triggers are disabled in the TRGR command, LPST defines status field.

V

Volume measurement

(a) General

Based on measured Level, tank shape and tank dimensions, GaugerGSM/485 can calculate and report Volume rather than Distance or Level. Configuration of Volume elements can only be executed using the PC configuration method.

Currently, three tank shapes are supported:

- Box shaped
- Horizontal cylindrical tanks with curved or non-curved sides
- Vertical cylindrical tank with curved or non-curved bottom-side

(b) Box shaped

This section defines a rectangular shaped tank. Only the two horizontal lengths are required (X and Y). The height of the tank is not required and assumes identical with EMP (distance to empty level).

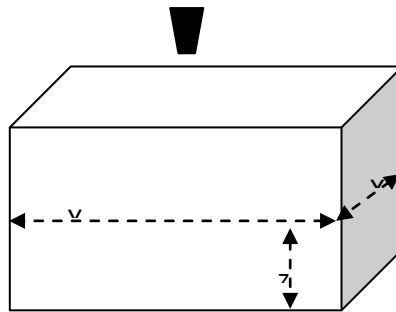

Figure 29 - Box shaped tank

For advanced users: The box shaped tank may also represent any other tank if Volume (V) and Level (L) are linearly related in that tank. Mathematically stated, if $V = k * L$ where k is a constant. For such a tank, enter X=1 and Y=k.

(c) Horizontal cylindrical tanks

Horizontal cylindrical tank with circular cross section and curved or straight sides:

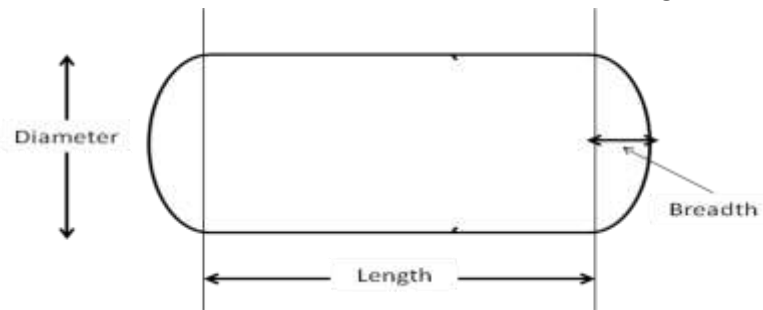

Figure 30 - Cylindrical horizontal tank

The length (horizontal dimension), diameter (vertical dimension) and breadth (thickness of the concave side) should be defined. With this tank shape, empty level must be referenced from the actual bottom of the tank. Otherwise, measurements will be incorrect. Typically, empty level will be several tens of cm or inches larger than diameter, reflecting the fact that the sensor is installed on a raised manhole, extension pipe or flange. Setting an empty level which is smaller than the diameter implies that the sensor is inside the tank.

(d) Vertical cylindrical tanks

This case defines a vertical cylindrical tank with flat or curved bottom and circular cross section.

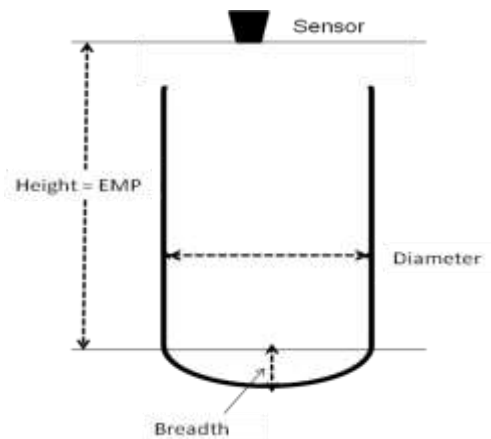

Figure 31 - Cylindrical vertical tank

The diameter (horizontal dimension) and breadth (or zero) should be defined. The height is assumed same as EMP (distance to empty level).

See also the section: "Interdependencies" in this chapter.

0-9

4-20 communications – Applicable to Gauger420 ONLY

(a) 4-20 Setup

Gauger420 is powered by two-wires which also carry measurement information. Measurement related information is conveyed by current magnitude which may take any value between 4mA and 20mA.

During setup, the user determines:

- Which process variable is represented by the electrical current
- The measurement value of the process variable which represented by 4mA
- The measurement value of the process variable which represented by 20mA
- The current value representing an error

Measured values are represented by an interpolated electrical current in-between 4mA and 20mA. The electrical current is interpreted as follows:

$$\text{Measurement..value} = \dots\{\text{value..represented..by..4mA}\} + \dots\{\text{value..represented..by..20mA} - \text{value..represented..by..4mA}\} * \dots(\text{current[mA]} - 4) / 16$$

It is recommended that values that represent a target far from the sensor will be set to 20mA while the close targets will be set to 4mA. For example, zero level represents a far target and is recommended, but not mandatory, to be mapped to 20mA rather than 4mA.

Fixed current is applicable to applications where HART is being used to convey measurement data and there is no need for electrical current variances. Fixed current is also applicable to applications where data is read directly from the display. It is recommended to set fixed current at 16mA. When set to a fixed current, the current does not carrying any measurement information.

The current may represent one of the following process variables:

- Level
- Distance
- Volume
- Flow
- Fixed current

An error state (for example, echo is lost for at least 3 minutes) may be represented by one of the following electrical currents:

- 22mA
- 3.6mA (or 3.8mA in some models)
- Holding the most recent good value
- 3.6mA or 22mA, the one nearest to the most recent legal value

Pressing any keypad button will cause the current to jump 22mA regardless of the 4-20 error settings. The current will return to represent measurement as soon as the device resumes normal measurement

Setup may be performed using the keypad or by PC configuration. Each is described in the appropriate chapter of this user manual.

The reader is further advised to review the interdependencies section in the PC configuration chapter.

(b) 4-20 Performance

When **Gauger420** is fed by low current, the performance of the system is modified to accommodate for the available electrical power. In particular, the rate of ultrasonic pulse transmissions is decreased. This decrease means that **Gauger420** response to rapidly moving targets is reduced. At low current and low voltage the pulse rate may be four times lower than the maximum rate.

(c) 4-20 constraints

4-20 settings must be configured after settings of Full and Empty levels. Once Full and Empty levels are configured, 4-20 settings are modified to their default values. For other constraints related to 4-20 setting please refer to the Interdependencies section.

(d) 4-20 default settings

Default settings when measuring level

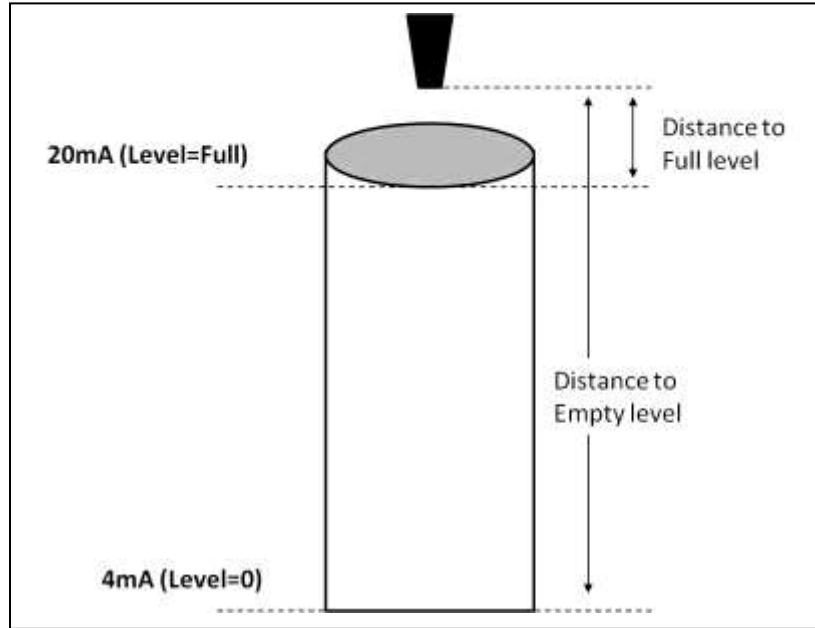

Figure 32 - Default 4-20 values for Level

Default settings when measuring Volume

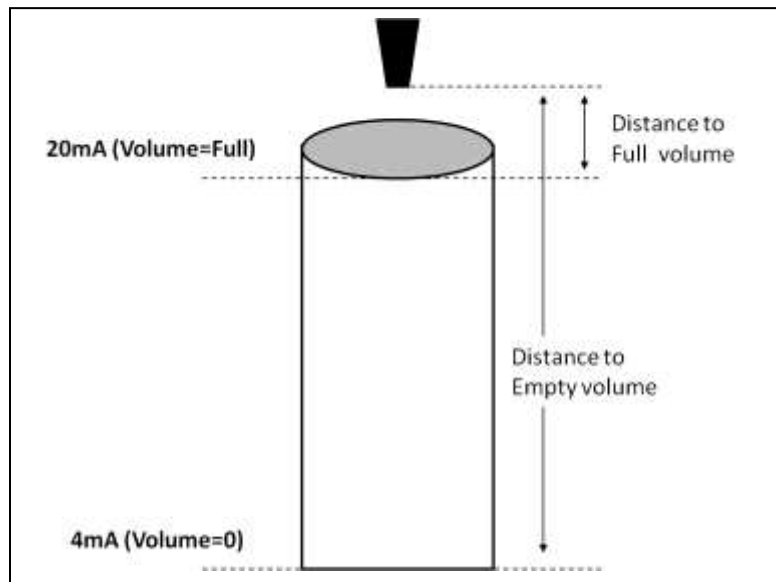

Figure 33 - Default 4-20 values for Volume

Default settings when measuring Distance

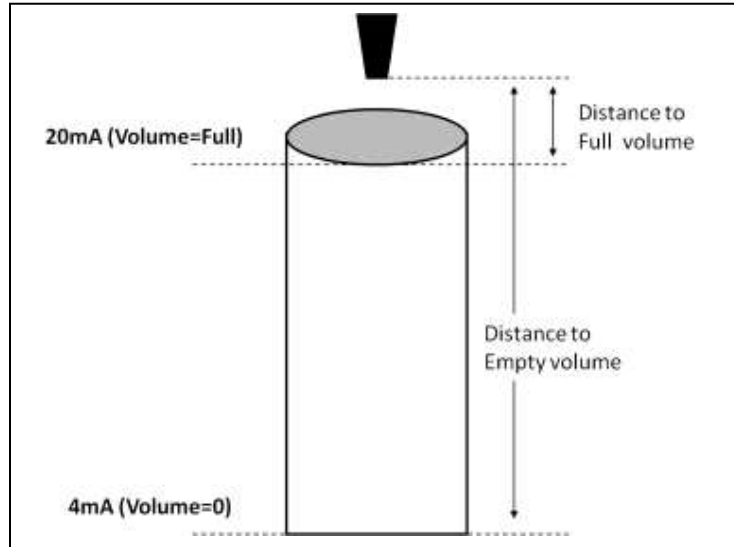

Figure 34 - Default 4-20 values for Distance

X. Troubleshooting

Symptom	Recommendation
Power On faults	
Gauger does not power on	<ol style="list-style-type: none"> 1. Check the rating of your power supply and verify these ratings are within the specifications of the GaugerGSM. 2. Check the electrical cables between the power supply and the Gauger. In particular, check the connections on the GaugerGSM.
Gauger powers on but does not measure	<ol style="list-style-type: none"> 1. Check the rating of your power supply and verify these ratings are within the specifications of the GaugerGSM. 2. Check if a USB connection powers up the GaugerGSM – do not use a USB connection to power up the GaugerGSM.
Gauger resets itself	<ol style="list-style-type: none"> 1. For GaugerGSM and for some firmware versions, GaugerGSM will reset itself periodically every two minutes or so if SIM card is not inserted. 2. If level measurement is absolutely fixed for 20 minutes, Gauger will reset itself.
Ultrasonic related faults	
Status line 1 reports constant ECHO SEARCH	<ol style="list-style-type: none"> 1. Check your target is between 15 cm and 8 meters (6 meters for solids). 2. Verify that the sensor is precisely directed towards the target. 3. Check the sensor face and make sure the face is clear of dust or dirt. 4. If you use an extension pipe, recheck all the recommendations stated in the extension pipe section in this manual.
Level measurement is incorrect	<ol style="list-style-type: none"> 1. Check that distance measurement is correct. Verify the settings of Full level and of Far Blocking Distance.
Level measurement displays Full level continuously	<ol style="list-style-type: none"> 1. Check and clear out physical disturbances above the empty level. 2. If you are using an extension pipe, increase NBD to a distance which is 2-3 cm beyond the edge of the pipe.
Cellular related faults	
Line status 2 displays error messages such as registration fail or GSM SIM fail	<ol style="list-style-type: none"> 1. Verify you have properly inserted a SIM card into GaugerGSM. 2. Carefully walk through the SIM instructions in the installation chapter. 3. Reposition your cellular antenna, the cellular coverage may be weak in your area.
Line status 2 displays SMS or GPRS SENT but no SMS or GPRS message is received	<p>SMS: 1. Verify the correctness of the destination phone number that you entered into GaugerGSM. Review the rules for entering a phone number as described in this manual. Remember, it is your responsibility to enter a valid phone number.</p> <p>GPRS: 1. Verify the correctness of the IP address and port number that you configured with the aid of a PC. Check that the server is up and running.</p>
Line status 2 reports GSM is OK but no SMS / GPRS	<ol style="list-style-type: none"> 1. Check if the reporting interval you entered in the GaugerGSM is correct. Notice that reporting interval is entered in seconds so that half an hour

messages are sent	would be entered as 1800 and five minutes would be entered as 300. 2. Check if the reporting deviation is set to zero.
GaugerGSM powers on but does not send a GPRS message after 1 minute	<ol style="list-style-type: none"> 1. Check if the SIM used supports GPRS 2. Check if GPRS network is online 3. Check if remote server is online 4. Activate the \$MLOG 1\$ USB command. Verify that the first responded value is no less than 10, if not relocate the Gauger while observing this value. 5. Check Gauger configuration using \$STAT 0\$ command : <ol style="list-style-type: none"> a. DATA command should show 1, 3 or 4. b. User, password and APN in GPRS command should be configured according to GPRS cellular provider information. c. IP address and port number should match the ones defined on the remote server. d. Gauger name configured via the NAME command should match the one defined on the remote server (required in the Site Monitoring Center (SMC) software.
GaugerGSM powers on but does not send a GPRS message after 1 minute even though all GPRS parameters viewed via STAT command are correct and network is OK	<ol style="list-style-type: none"> 1. reconfigure GPRS command manually , verify no white characters are entered , verify Gauger responds with OK message and the correct parameter value 2. Reconfigure NAME command manually , verify no white characters are entered , verify Gauger responds with OK message and the correct parameter value 3. Verify using \$STAT 0\$ command , GPRS parameters are correct
GaugerGSM powers on but does not send a GPRS message after 1 minute even though all GPRS parameters manually reconfigured are correct	<ol style="list-style-type: none"> 1. Reset the Gauger 2. Activate the USB \$MLOG 2\$ command 3. Record HT display for at least the time defined in SMST command and send to the manufacturer SolidAT.
GaugerGSM sends GPRS messages not accordingly to interval defined in SMST command	<ol style="list-style-type: none"> 1. Reset the Gauger 2. Activate the USB \$MLOG 2\$ command 3. Activate the \$ENDT\$ command 4. Record HT display for at least the time defined in SMST command and send to the manufacturer SolidAT.