

Autonics RusAutomation

TEMPERATURE CONTROLLER

T4L/T4LA/T4LP SERIES

MANUAL



Thank you very much for selecting Autonics products.
For your safety, please read the following before using.

Caution for your safety

- ※Please keep these instructions and review them before using this unit.
- ※Please observe the cautions that follow:
- Warning** Serious injury may result if instructions are not followed.
- Caution** Product may be damaged, or injury may result if instructions are not followed.
- ※The following is an explanation of the symbols used in the operation manual.
- Caution:**Injury or danger may occur under special conditions.

Warning

- In case of using this unit with machineries(Nuclear power control, medical equipment, vehicle, train, airplane, combustion apparatus, entertainment or safety device etc), it requires installing fail-safe device, or contact us for information on type required.
It may result in serious damage, fire or human injury.
- This unit must be mounted on panel.
It may give an electric shock.
- Do not repair or checkup when power on.
It may give an electric shock.
- Do not disassemble and modify this unit, when it requires.
If needs, please contact us.
It may give an electric shock and cause a fire.
- This product is a combined use of 110/220VAC, please check the terminal whe connect.
It may cause a fire.

Caution

- This unit shall not be used outdoors.
It might shorten the life cycle of the product or give an electric shock.
- When wire connection, No.20AWG(0.50mm²) should be used and screw bolt on terminal block with 0.74N·m to 0.90N·m strength.
It may result in malfunction or fire due to contact failure.
- Please observe specification rating.
It might shorten the life cycle of the product and cause a fire.
- Do not use the load beyond rated switching capacity of Relay contact.
It may cause insulation failure, contact melt, contact failure, relay broken, fire etc.
- In cleaning the unit, do not use water or an oil-based detergent.
It might cause an electric shock or fire that will result in damage to this product.
- Do not use this unit at place where there are flammable or explosive gas, humidity, direct ray of the sun, radiant heat, vibration, impact etc.
It may cause a fire or explosion.
- Do not inflow dust or wire dregs into inside of this unit.
It may cause a fire or mechanical trouble.
- Please wire properly after checking the polarity of terminals when connect thermocouples.
It may cause a fire or explosion.

Dimensions

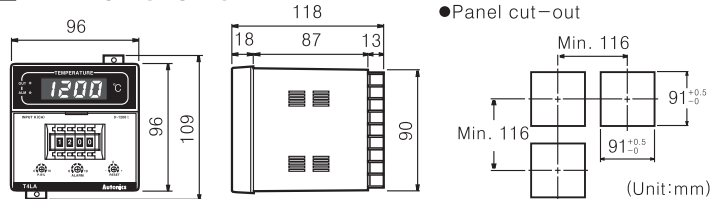

Connections

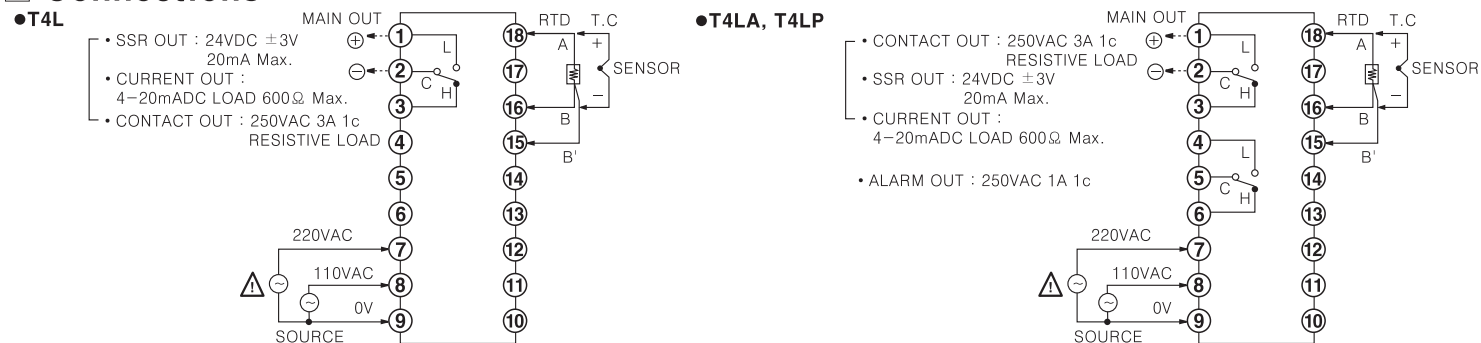

※ The above specifications are subject to change and some models may be discontinued without notice.

Ordering information

T 4 L — B 3 R K 4 C

① Item	T	Temperature
② Digit	4	4 Digit
③ Size	L	DIN W96 × H96mm
④ Alarm/Sub output mode	A	Alarm output(High + Low)
	P	Double output
⑤ Control mode	B	ON/OFF, Proportional control
⑥ Power supply	3	110/220VAC 50/60Hz
⑦ Output mode	R	Relay output
	S	SSR output
	C	Current output(4-20mADC)
	K	K(CA) Type
	J	J(IC) Type
	R	R(PR) Type
	P	Pt100Ω
⑧ Sensor input type	0	-99.9 to 199.9
	1	0 to 99.9
	2	0 to 199.9
	4	0 to 399
	8	0 to 799
	C	0 to 1200
	F	600 to 1600
⑩ Unit	C	℃

Specifications

Model	T4L	T4LA	T4LP
Power supply	110/220VAC 50/60Hz		
Allowable voltage range	90 to 110% of rated voltage		
Power consumption	3VA		
Display method	7 Segment LED Display		
Display accuracy	F · S ± 0.5% rdg ± 1digit		
Setting method	Digital setting		
Setting accuracy	F · S ± 0.5%		
Sensor input	Thermocouples:K(CA), J(IC), R(PR)/RTD:Pt100Ω		
Input line resistance	Thermocouples:Max. 100Ω, RTD:Max. 5Ω per a wire		
Control	ON/OFF	Hysteresis:F · S 0.2 to 3% variable	
	Proportional	Proportional band:F · S 1 to 10% variable, Period:20sec. fixed	
	Alarm	F · S 0 to 10% variable	
Reset VR range	F · S ± 3% variable(Correction of control deviation)		
Control output	<ul style="list-style-type: none"> Relay contact output:250VAC 3A 1c SSR output:24VDC ± 3V 20mA max. Current output:4-20mADC(Load 600Ω max.) Alarm contact output:250VAC 1A 1c(T4LA) Double contact output:250VAC 2A 1c(T4LP) 		
Self-diagnosis	Built-in burn out function		
Insulation resistance	Min. 100MΩ (at 500VDC)		
Dielectric strength	2000VAC 50/60Hz for 1 minute		
Noise strength	± 2kV the square wave noise(pulse width:1μs) by the noise simulator		
Vibration	Mechanical	0.75mm amplitude at frequency of 10 to 55Hz in each of X, Y, Z directions for 1 hour	
	Malfunction	0.5mm amplitude at frequency of 10 to 55Hz in each of X, Y, Z directions for 10 minutes	
Shock	Mechanical	300m/s ² (Approx. 30G) 3 times at X, Y, Z direction	
	Malfunction	100m/s ² (Approx. 10G) 3 times at X, Y, Z direction	
Relay life cycle	Mechanical	Min.10,000,000 times	
	Electrical	Min.100,000 times(250VAC 3A resistive load)	
Ambient temperature	-10 to 50℃ (at non-freezing status)		
Storage temperature	-25 to 65℃ (at non-freezing status)		
Ambient humidity	35 to 85%RH		
Weight	Approx. 468g	Approx. 484g	Approx. 487g

Temperature range for each sensor

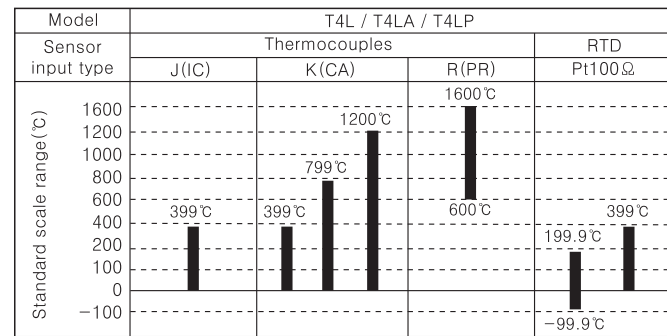

ON/OFF control

The drawing shows that the output turns on when the temperature is lower than the set value.(Heater ON) The output turns off when temperature is equal or higher than the set value.(Heater OFF)

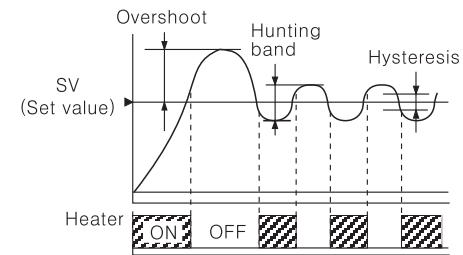

As like above picture, the control value is up and down by set value, it is called Hunting. And Overshoot is occurred at initial point when just power on. If the Hunting and Overshoot is less, it will be a good control.

Double set temperature controller(T4LP)

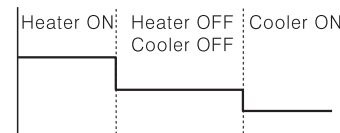

It is able to control a heater and a cooler with 1 piece of double set temperature controller. The 1st(Low set) output is for a heater control and 2nd(Hi set) output is for a cooler control.

Hysteresis

The ON/OFF control has hysteresis due to reduce the chattering or noise affection. Generally make hysteresis bigger for compressor or cooler due to this reason.

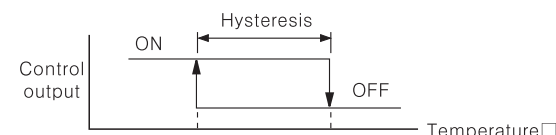

Ex)If temperature range is 0 to 400℃ and hysteresis is 0.5%(2℃), therefore when the set value is 300℃, 301℃:OFF and 299℃:ON.

Proportional control

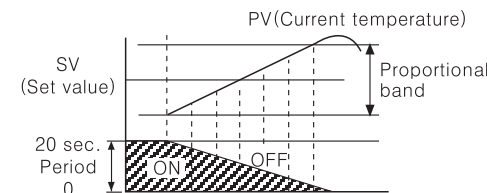

※If the temperature is getting higher, ON time will be shorter.

Pulse output type of ON/OFF such as Relay output or SSR output(Voltage output) are ON/OFF repeatedly with constant cycle. When the PV and SV is the same, the output value will be 50% and ON/OFF time rate is 1:1.

How to select ON/OFF or proportional by plug pin

- Control mode selection by plug pin

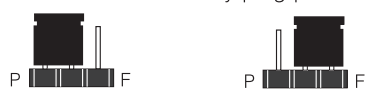

* P : Proportional control * F : ON/OFF control

Function

- BURN OUT detection function :
Make the output OFF when the thermocouple is broken.
- Voltage output :
The output is 24VDC ± 3V 20mA max for driving external SSR.
- Direct/Reverse operation : Reverse operation is the output ON when the display value is lower than set value, Direct operation is for cooler.
- ※This product operates as reverse operation.

Load connection

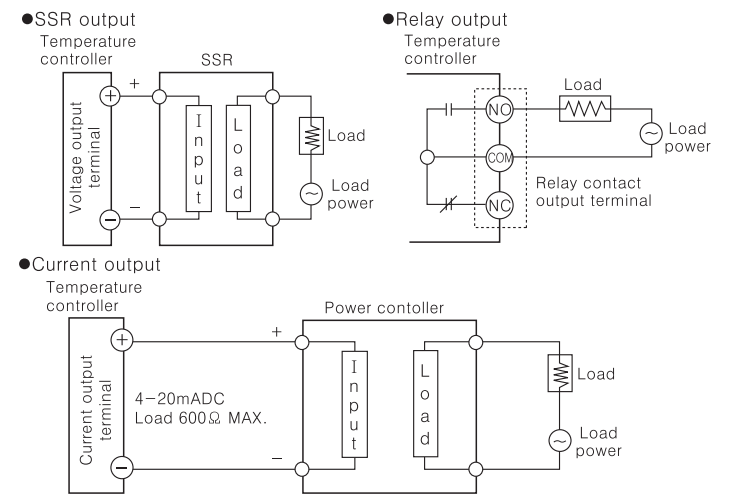

Applications

Food	Packaging machinery, Banding machinery
Plastic	Plastic machinery, Film making system, etc.
Industry	Electric furnace, Auto soldering machine, Drying machine, etc.
Textile	Body press, Textile machine, Sizing machine
Etc.	Cement making machinery

Caution for using

- Installation environment
 - ①It shall be used indoor
 - ②Altitude Max. 2000m
 - ③Pollution Degree 2
 - ④Installation Category II.
- Please use the terminal(M3.5, Max.7.2mm) when connect the AC power source.
- Please use separated line from high voltage line or power line in order to avoid inductive noise.
- Please install power switch or circuit-breaker in order to cut power supply off.
- The switch or circuit-breaker should be installed near by users.
- Do not use this product as Volt-meter or Ampere-meter, this is a temperature controller.
- Be sure to use compensating wire when extends wire from controller, otherwise the temperature deviation will be occurred at the part where wires are connected each other.
- In case of using RTD sensor, 3wire type must be used.
If it needs to extend the line, 3wires must be used with the same thickness as the line. It might cause the deviation of temperature if the resistance of line is different.
- In case of making power line and input signal line close, line filter for noise protection should be installed at power line and input signal line should be shielded.
- Keep away from the high frequency instruments. (High frequency welding machine & sewing machine, big capacitive SCR controller)
- When change the control mode, please apply power after change the mode switch.
- Do not connect power line on No.15, 16, 18 of terminal block for the sensor.

※It may cause malfunction if above instructions are not followed.

Main products

- Photoelectric sensors
- Fiber optic sensors
- Door sensors
- Door side sensors
- Area sensors
- Proximity sensors
- Pressure sensors
- Rotary encoders
- Connector/Sockets
- Switching mode power supplies
- Control switches/Lamps/Buzzers
- I/O Terminal Blocks & Cables
- Stepper motors/drivers/motion controllers
- Graphic/Logic panels
- Field network devices
- Laser marking system(Fiber, CO₂, Nd:YAG)
- Laser welding/soldering system
- Temperature controllers
- Temperature/Humidity transducers
- SSR/Power controllers
- Counters
- Timers
- Panel meters
- Tachometer/Pulse(Rate) meters
- Display units
- Sensor controllers

ООО "РусАвтоматизация"
454010 г. Челябинск, ул. Гагарина 5, оф. 507
тел. 8-800-775-09-57 (звонок бесплатный),
тел.: (351)799-54-26, тел./факс (351)211-64-57
info@rusautomation.ru; www.rusautomation.ru
русавтоматизация.рф

EP-KE-03-0065B