



Operating instructions
Combined pressure sensor

efectorsoo

PY2209

UK

11450571 / 00 05 / 2014

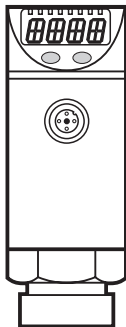

Contents

1 Preliminary note.....	3
1.1 Symbols used.....	3
2 Safety instructions.....	3
3 Function and features.....	4
4 Function.....	4
4.1 Parameter setting, evaluation.....	4
4.2 Switching function.....	5
4.3 Analogue function.....	5
5 Installation.....	7
6 Electrical connection.....	7
7 Operating and display elements.....	9
8 Menu.....	10
8.1 Menu structure.....	10
8.2 Explanation of the menu.....	11
9 Parameter setting.....	12
9.1 Parameter setting general.....	12
9.2 Setting the output signal.....	13
9.2.1 Setting the output function.....	13
9.2.2 Setting the switching limits.....	14
9.2.3 Scaling the analogue value.....	14
9.3 User settings (optional).....	14
9.3.1 Setting the unit of measurement for the system pressure.....	14
9.3.2 Configuring the display.....	15
9.3.3 Zero-point calibration.....	15
9.3.4 Setting the delay time for the switching outputs.....	15
9.3.5 Setting the output polarity.....	15
9.3.6 Setting the damping for the switching outputs.....	15
9.3.7 Setting the damping for the analogue output.....	16
9.4 Service functions.....	16
9.4.1 Reading the min./max. values for the system pressure.....	16
10 Operation.....	17
10.1 Read the set parameter values.....	17
10.2 Fault indication.....	17

11	Setting ranges.....	17
12	Factory setting.....	18

1 Preliminary note

1.1 Symbols used

- ▶ Instruction
- > Reaction, result
- [...] Designation of buttons, switches or indications
- Cross-reference



Important note

Non-compliance can result in malfunctions or interference.

UK

2 Safety instructions

- Read this document before installing the unit. Ensure that the product is suitable for your application without any restrictions.
- Non-adherence to the operating instructions or technical data can lead to personal injury and/or damage to property.
- Improper or non-intended use may lead to malfunctions of the unit or to unwanted effects in your application. That is why installation, electrical connection, set-up, operation and maintenance of the unit must only be carried out by qualified personnel authorised by the machine operator.
- In order to guarantee the correct condition of the device for the operating time, the device must only be used in media with which the wetted parts are compatible (→ Technical data).
- The responsibility whether the measurement devices are suitable for the respective application lies with the operator. The manufacturer assumes no liability for consequences of misuse by the operator. Improper installation and use of the devices result in a loss of the warranty claims.

3 Function and features

The pressure sensor detects the system pressure of machines and installations.

Applications

Type of pressure: relative pressure

Order no.	Measuring range		Permissible overload pressure		Bursting pressure	
	PSI	mbar	PSI	bar	PSI	bar
PY2209	-15...15	-1036...1036	290	20	725	50

$$\text{MPa} = \text{bar} \div 10 \quad / \quad \text{kPa} = \text{bar} \times 100$$



Static and dynamic overpressures exceeding the indicated overload pressure are to be avoided by taking appropriate measures.

The indicated bursting pressure must not be exceeded. Even if the bursting pressure is exceeded only for a short time, the unit can be destroyed. NOTE: Risk of injury!



Pressure Equipment Directive (PED):

The units comply with section 3, article (3) of the Directive 97/23/EC and are designed and manufactured for “non-superheated liquids” of group 2 fluids in accordance with the sound engineering practice.

4 Function

4.1 Parameter setting, evaluation

- The unit shows the current system pressure on its display.
- It generates 2 output signals according to the parameter setting.

OUT1	• switching signal for pressure limit values.
OUT2	• switching signal for pressure limit values. • analogue signal for pressure (4...20 mA or 0...10V).

4.2 Switching function

OUTx changes its switching state if it is above or below the set switching limits (SPx, rPx). The following switching functions can be selected:

- Hysteresis function / normally open: [OUx] = [Hno] (→ fig. 1).
- Hysteresis function / normally closed: [OUx] = [Hnc] (→ fig. 1).

First the set point (SPx) is set, then the reset point (rPx) at the requested distance.

- Window function / normally open: [OUx] = [Fno] (→ fig. 2).
- Window function / normally closed: [OUx] = [Fnc] (→ fig. 2).

The width of the window can be set by means of the distance between SPx and rPx. SPx = maximum value, rPx = minimum value.

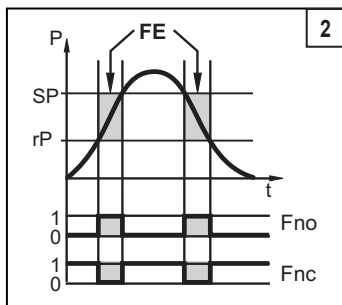
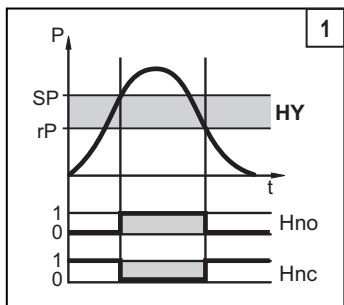

P = system pressure; HY = hysteresis; FE = window

4.3 Analogue function

- [OU2] defines whether the set measuring range is provided as a 4...20 mA signal ([OU2] = [I]) or a 0...10 V signal ([OU2] = [U]).
- The analogue start point [ASP] determines at which measured value the output signal is 4 mA or 0 V.
- The analogue end point [AEP] determines at which measured value the output signal is 20 mA or 10 V.

Minimum distance between [ASP] and [AEP] = 25 % of the span.

Voltage output 0 ... 10 V

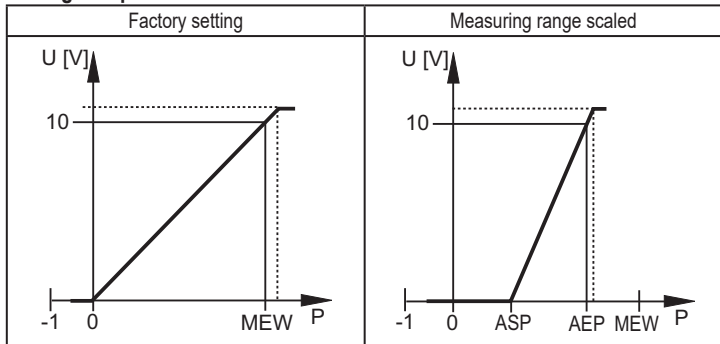

P = system pressure, MEW = final value of the measuring range

In the set measuring range the output signal is between 0 and 10 V.

It is also indicated:

System pressure above the measuring range: output signal > 10 V.

Current output 4 ... 20 mA

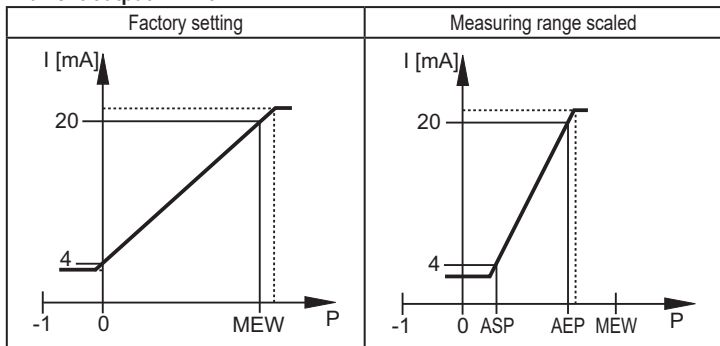

P = system pressure, MEW = final value of the measuring range

In the set measuring range the output signal is between 4 and 20 mA.

Also signalled:

- System pressure above the measuring range: output signal > 20 mA.
- System pressure below the measuring range: output signal 4...3.8 mA.

5 Installation



Before mounting and removing the sensor, make sure that no pressure is applied to the system.

- ▶ Insert the unit in a 1/4" NPT process connection.
- ▶ Tighten firmly.

6 Electrical connection



The unit must be connected by a qualified electrician.

The national and international regulations for the installation of electrical equipment must be adhered to.

Voltage supply to SELV, PELV.

- ▶ Disconnect power.
- ▶ Connect the unit as follows:

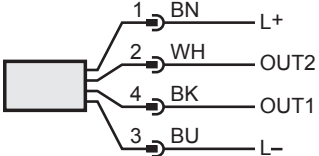
Core colours			
BK	black		
BN	brown		
BU	blue		
WH	white		

OUT1: Switching output

OUT2: Switching output / analogue output

Colours to DIN EN 60947-5-6

Example circuits

2 x p-switching

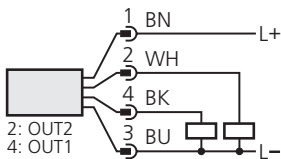

2 x n-switching

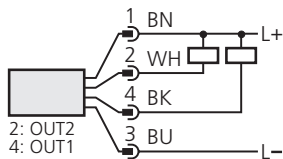

1 x p-switching / 1 x analogue

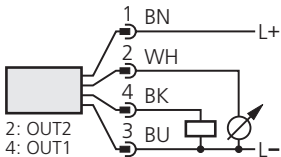

1 x n-switching / 1 x analogue

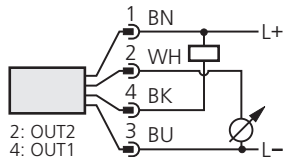

7 Operating and display elements

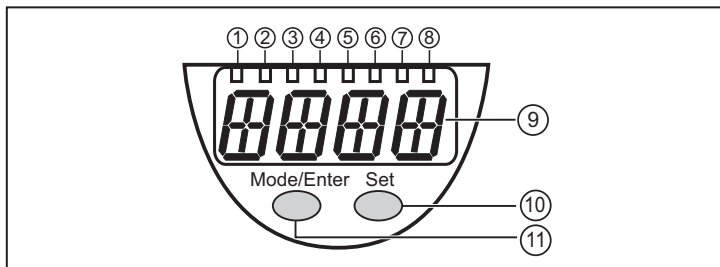

1 to 8: Indicator LEDs

- LED 1 to LED 6 = system pressure in unit of measurement as indicated on the label.
- LEDs 4 to 6 not used for units with 3 adjustable units of measurement.
- LEDs 5 and 6 not used for units with 4 adjustable units of measurement.
- LED 7, LED 8 = switching state of the respective output.

9: Alphanumeric display, 4 digits

- Indication of the current system pressure.
- Indication of the parameters and parameter values.

10: Set pushbutton

- Setting of the parameter values (scrolling by holding pressed, incremental by pressing briefly).

11: Mode/Enter pushbutton

- Selection of the parameters and acknowledgement of the parameter values.

8 Menu

8.1 Menu structure

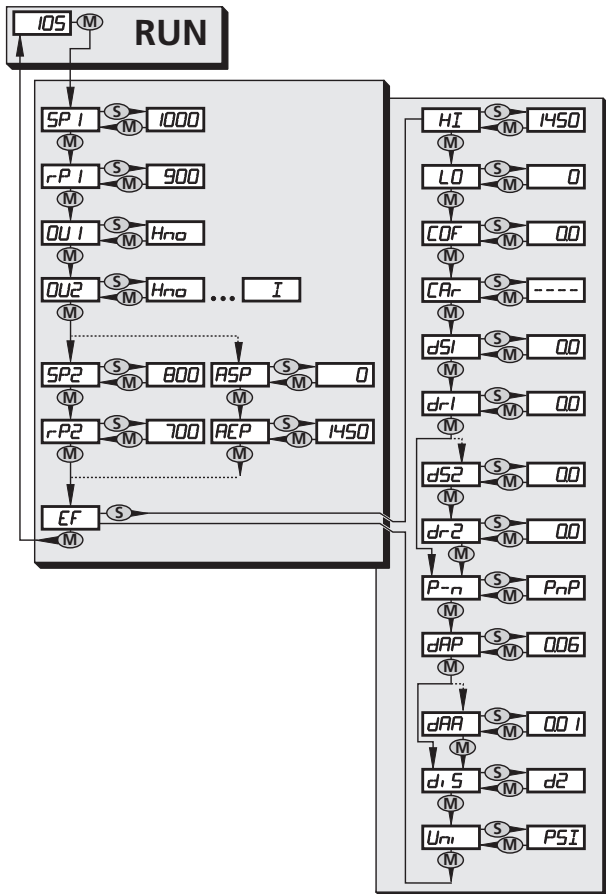

8.2 Explanation of the menu



SP1/rP1	Maximum / minimum value for system pressure, at which output 1 changes its switching status.
SP2/rP2	Maximum / minimum value for system pressure, at which output 2 changes its switching status.
OU1	Output function for OUT1: <ul style="list-style-type: none"> Switching signal for the limit values: hysteresis function [H ..] or window function [F ..], normally open [. no] or normally closed [. nc] each.
OU2	Output function for OUT2: <ul style="list-style-type: none"> Switching signal for the limit values: hysteresis function [H ..] or window function [F ..], normally open [. no] or normally closed [. nc] each. Analogue signal for the current system pressure: 4...20 mA [I] or 0...10 V [U].
ASP	Analogue start point for the system pressure: measured value at which 4 mA / or 0 V are output.
AEP	Analogue end point for the system pressure: measured value at which 20 mA / or 10 V are output.
EF	Extended functions / Opening menu level 2.
HI	Maximum value memory for the system pressure.
LO	Minimum value memory for the system pressure.
COF	Zero point calibration.
CAr	Calibration reset.
dS1/dS2	Switch-on delay for für OUT1 / OUT2.
dr1/dr2	Reset delay für OUT1 / OUT2.
P-n	Output polarity: pnp / npn
dAP	Damping for the switching outputs
dAA	Damping for the analogue output
diS	Update rate and orientation of the display.
Uni	Standard unit of measurement for the system pressure.

9 Parameter setting

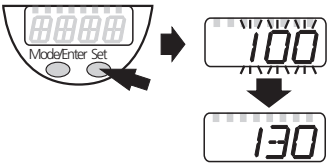

During the parameter setting process the unit remains in the operating mode. It continues its monitoring function with the existing parameters until parameter setting has been terminated.

9.1 Parameter setting general

Each parameter setting requires 3 steps:

1 Parameter selection ▶ Press [Mode/Enter] until the requested parameter is displayed.	
2 Setting of the parameter value ▶ Press [Set] and keep it pressed. > Current setting value of the parameter flashes for 5 s. > After 5 s: The setting value is changed: incremental by pressing briefly or scrolling by holding pressed.	
The numerical values are incremented continuously. If the value is to be reduced: Let the display move to the maximum setting value. Then the cycle starts again at the minimum setting value.	
3 Acknowledgement of the parameter value ▶ Press [Mode/Enter] briefly. > The parameter is displayed again. The new setting value is stored.	
Setting of other parameters: ▶ Start again with step 1.	
Finishing the parameter setting: ▶ Press [Mode/Enter] several times until the current measured value is displayed or wait for 15 s. > The unit returns to the operating mode.	

- Changing from menu level 1 to menu level 2:

<ul style="list-style-type: none"> Press [Mode/Enter] until [EF] is displayed. 	
<ul style="list-style-type: none"> Press [Set] briefly. > The first parameter of the sub-menu is displayed (here: [HI]). 	

- Locking / unlocking

UK

The unit can be locked electronically to prevent unintentional wrong settings.

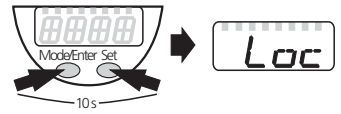
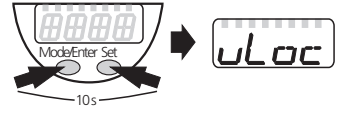
<ul style="list-style-type: none"> Make sure that the unit is in the normal operating mode. Press [Mode/Enter] + [Set] for 10 s. > [Loc] is displayed. 	
<p>During operation: [Loc] is briefly displayed if you try to change parameter values.</p>	
<ul style="list-style-type: none"> Press [Mode/Enter] + [Set] for 10 s. > [uLoc] is displayed. 	

On delivery: Unlocked.

- Timeout:

If no button is pressed for 15 s while the parameters are being set, the unit returns to the operating mode with unchanged values.

9.2 Setting the output signal

9.2.1 Setting the output function

<ul style="list-style-type: none"> Select [OU1] and set the switching function: [Hno] = hysteresis function / normally open, [Hnc] = hysteresis function / normally closed, [Fno] = window function / normally open, [Fnc] = window function / normally closed. 	
--	---

<ul style="list-style-type: none"> ▶ Select [OU2] and set the function: [Hno] = hysteresis function / normally open, [Hnc] = hysteresis function / normally closed, [Fno] = window function / normally open, [Fnc] = window function / normally closed, [I] = current signal proportional to the pressure 4...20 mA, [U] = voltage signal proportional to the pressure 0...10 V. 	<i>OU2</i>
---	------------

9.2.2 Setting the switching limits

<ul style="list-style-type: none"> ▶ Select [SP1] / [SP2] and set the value at which the output switches. 	<i>SP 1</i> <i>SP 2</i>
<ul style="list-style-type: none"> ▶ Select [rP1] / [rP2] and set the value at which the output switches back. rPx is always lower than SPx. The unit only accepts values which are lower than SPx. 	<i>r-P 1</i> <i>r-P 2</i>

9.2.3 Scaling the analogue value

<ul style="list-style-type: none"> ▶ Select [ASP] and set value at which 4 mA / 0 V are output. 	<i>ASP</i>
<ul style="list-style-type: none"> ▶ Select [AEP] and set value at which 20 mA / 10 V are output. Minimum distance between ASP and AEP = 25 % of the span (scaling factor 1:4). 	<i>AEP</i>

9.3 User settings (optional)

9.3.1 Setting the unit of measurement for the system pressure

<ul style="list-style-type: none"> ▶ Select [Uni] and set the unit of measurement: [mbAr] [kPA] [PSI] [IH2O] [inHG] 	<i>Uni</i>
---	------------

9.3.2 Configuring the display

<ul style="list-style-type: none">▶ Select [diS] and set update rate and orientation of the display: [d1]: Update of the measured value every 50 ms. [d2]: Update of the measured value every 200 ms. [d3]: Update of the measured value every 600 ms. [Ph]: Display of the measured peak value remains for a short time (peak hold). [rd1], [rd2], [rd3], [rPh]: Display like d1, d2, d3, Ph; rotated by 180°. [OFF]: The display is deactivated in the operating mode.	<i>d1 S</i>
--	-------------

9.3.3 Zero-point calibration

UK

<ul style="list-style-type: none">▶ Select [COF] and set a value between -5 % and 5 % of the measuring span. The internal measured value "0" is shifted by this value.	<i>COF</i>
Resets the calibration set by COF to the value set at the factory. <ul style="list-style-type: none">▶ Press [Mode/Enter] until [CAr] is displayed.▶ Press [Set] and keep it pressed until [----] is displayed.▶ Press [Mode/Enter] briefly.	<i>CAr</i>

9.3.4 Setting the delay time for the switching outputs

[dS1] / [dS2] = switch-on delay for OUT1 / OUT2. [dr1] / [dr2] = switch-off delay for OUT1 / OUT2. <ul style="list-style-type: none">▶ Select [dS1], [dS2], [dr1] or [dr2], set value between 0.1 und 50 s (at 0.0 the delay time is not active).	<i>dS1</i> <i>dS2</i> <i>dr1</i> <i>dr2</i>
--	--

9.3.5 Setting the output polarity

<ul style="list-style-type: none">▶ Select [P-n], set [PnP] or [nPn].	<i>P-n</i>
---	------------

9.3.6 Setting the damping for the switching outputs

<ul style="list-style-type: none">▶ Select [dAP], set value between 0.01 ... 4.00 s; (at 0.00 [dAP] time is not active). dAP-value = response time between pressure change and change of the switching status in seconds (s). Correlation between switching frequency and [dAP]: $f_{\max} = 1 \div 2dAP..$	<i>dAP</i>
--	------------

9.3.7 Setting the damping for the analogue output

- ▶ Select [dAA], set value between 0.01 ... 4.00 s; (at 0.00 [dAA] time is not active).

dAA-value = response time between pressure change and change of the switching status in seconds (s).

dAA

9.4 Service functions

9.4.1 Reading the min./max. values for the system pressure

- ▶ Select [HI] or [LO], press [Set] briefly.
[HI] = maximum value, [LO] = minimum value.

Delete memory:

- ▶ Select [HI] or [LO].
- ▶ Press [Set] until [----] is displayed.
- ▶ Press [Mode/Enter] briefly.

HI
LO

10 Operation

After power on of the supply voltage the unit is in the Run mode (= normal operation). It carries out its measurement and evaluation functions and generates output signals according to the set parameters.

Operating indicators → chapter 7 Operating and display elements.

10.1 Read the set parameter values

- ▶ Press [Mode/Enter] briefly to scroll the parameters.
- ▶ Press [Set] briefly to indicate the corresponding parameter value for 15 s. After another 15 s the unit returns to the Run mode.

UK

10.2 Fault indication

[OL]	overload pressure (measuring range exceeded)
[UL]	underpressure range (measuring range below the minimum value)
[SC1]	short circuit in OUT1*
[SC2]	short circuit in OUT2*
[SC]	short circuit in both switching outputs*
*The output concerned is switched off as long as the short circuit exists. This faults are indicated even if the display is deactivated.	

11 Setting ranges

		SP1 / SP2		rP1 / rP2		ASP		AEP		ΔP
		min	max	min	max	min	max	min	max	
PY2209	PSI	-14,8	15	-14,9	14,9	-15	7,5	-7,5	15	0,1
	inH2O	-411	415	-414	412	-415	208	-208	415	1
	inHg	-30,2	30,5	-30,4	30,3	-30,5	15,3	-15,2	30,5	0,1
	mbar	1024	1036	-1032	1028	-1036	516	-516	1036	4
	kPa	-102,4	103,6	-103,2	102,8	-103,6	51,6	-51,6	103,6	0,4

ΔP = increments

12 Factory setting

	Factory setting	User setting
SP1	25 % MS*	
rP1	23 % MS*	
OU1	Hno	
OU2	I	
SP2	75 % MS*	
rP2	73 % MS*	
ASP	0 % MS*	
AEP	100 % MS*	
COF	0	
dS1	0.0	
dr1	0.0	
dS2	0.0	
dr2	0.0	
P-n	PnP	
dAP	0.06	
dAA	0.10	
diS	d2	
Uni	PSI	

* the indicated percentage of the measuring span of the respective sensor is set in PSI.
MS = measuring span