

T4LP

Dual setting type, High accuracy

■ Features

- Dual setting type
- High accuracy measuring function: $\pm 0.5\%$
- Control heater and cooler at once
- Use dual setting type of temperature when executing low temperature or precision control. In dual setting control type, the single output is operated as reverse, it is used for heater control. The dual output is used to control the operation of cooler normally. The dual output is also used for an alarm.



Please read "Caution for your safety" in operation manual before using.

■ Ordering information

T	4	L	P	-	B	3	R	P	4	C	
											Unit
											C
											°C
											Temperature range
										2	0 to 199.9
										4	0 to 399
										8	0 to 799
										C	0 to 1200
										F	600 to 1600
										Sensor input type	
										P	DPT100Ω
										J	J(IC)
										K	K(CA)
										R	R(PR)
										Control output	
										R	Relay output
										S	SSR drive voltage output
										C	Current output(DC4-20mA)
										Power supply	
										3	110/220VAC 50/60Hz
										Control method	
										B	ON/OFF, P control
										Sub output mode	
										P	Dual output
										Size	
										L	DIN W96×H96mm
										Digit	
										4	9999(4digit)
										Item	
										T	Temperature Controller

※Refer to the H-99 about sensor temperature range for selection.

■ Temperature range for each sensor

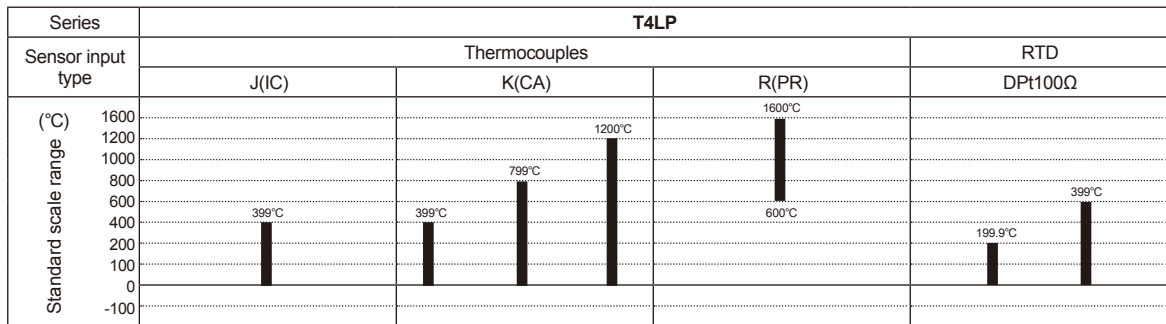

※In case, the sensor is R(PR) type, it is not available to indicate the temperature and control correctly.

■ Specifications

Series		T4LP
Power supply		110/220VAC 50/60Hz
Allowable voltage range		90 to 110% of rated voltage
Power consumption		Max. 3VA
Display method		7 Segment(red) LED method
Character size(W×H)		9.5×14.2mm
Display accuracy		F.S. ±0.5% rdg ±1digit
Setting type		Digital setting
Setting accuracy		F.S. ±0.5%
Sensor input		Thermocouples: K(CA), J(IC), R(PR) / RTD: DPT100Ω
Input line resistance		Thermocouples: Max. 100Ω, RTD: Allowable line resistance max. 5Ω per a wire
Control method	ON/OFF control	Hysteresis: F.S. 0.2 to 3% variable
	P control	Proportional band: F.S. 1 to 10%, Period: 20sec. fixed
RESET adjuster range		F.S. ±3% variable (revision of control deviation / only for P control)
Control output		<ul style="list-style-type: none"> Relay contact output: 1st out: 250VAC 3A 1c, 2nd out: 250VAC 2A 1c SSR drive voltage output: 24VDC ±3V 20mA Max. Current output: DC4-20mA (load 600Ω Max.)
Self-diagnosis		Built-in burn out function (cut off output when sensor is disconnected)
Insulation resistance		Min. 100MΩ(at 500VDC megger)
Dielectric strength		2,000VAC 50/60Hz for 1 min.
Noise resistance		±2kV the square wave noise(pulse width:1μs) by the noise simulator
Vibration	Mechanical	0.75mm amplitude at frequency of 10 to 55Hz(for 1 min.) in each of X, Y, Z directions for 1 hour
	Malfunction	0.5mm amplitude at frequency of 10 to 55Hz(for 1 min.) in each of X, Y, Z directions for 10 min.
Shock	Mechanical	300m/s ² (approx. 30G) in each of X, Y, Z directions for 3 times
	Malfunction	100m/s ² (approx. 10G) in each of X, Y, Z directions for 3 times
Relay life cycle	Mechanical	Min. 10,000,000 operations
	Electrical	Min. 100,000 operations(250VAC 3A at resistive load)
Environment	Ambient temperature	-10 to 50°C, storage: -25 to 65°C
	Ambient humidity	35 to 85%RH, storage: 35 to 85%RH
Unit weight		Approx. 487g

※F.S. is same with sensor measuring temperature range.

Ex) In case of using temperature is from 600 to 1600°C, Full scale is 1000.

※Environment resistance is rated at no freezing or condensation.

Autonics

■ Connections

※RTD: DPT100Ω(3-wire type) ※Thermocouple: K, J, R

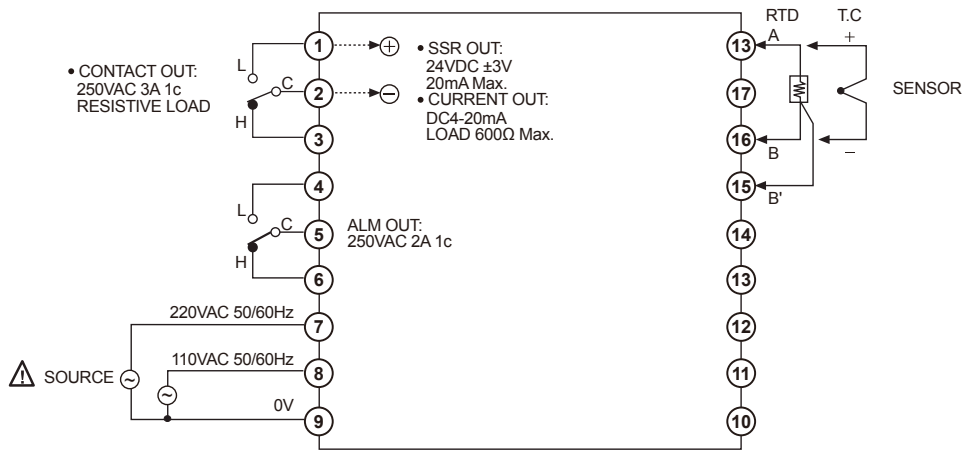

■ Dimensions

(unit: mm)

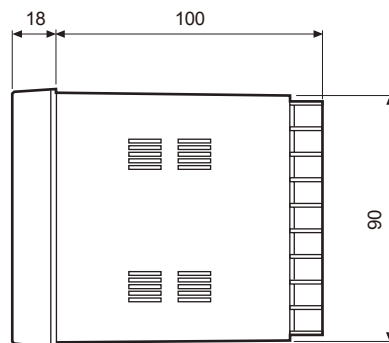
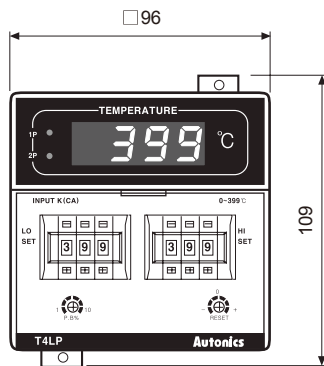

•Panel cut-out

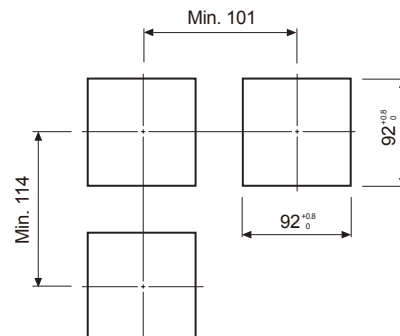

Autonics

■ Proper usage

◎ Operation

This controller has two outputs operated separately. In other words, it is able to set the values separately. Front LOW set runs with reverse operation as other common controllers and HIGH set runs by normal operation. It is able to control heater and cooler.



※ Terminal ①, ②, ③ are Low Set output terminals and terminal ④, ⑤, ⑥ are Hi Set output terminals.

◎ Using front adjuster

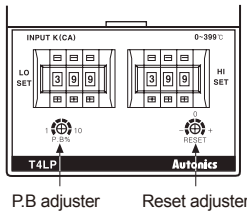

● P.B. adjuster

In case of ON/OFF control, set variable F.S. 0.2 to 3% of hysteresis and in case of P control, set variable F.S. 1 to 10% of hysteresis.

● Reset adjuster

It corrects offset can be occurred by P control and has F.S. $\pm 3\%$ of adjustable range. Do not operate the adjuster when it is used as ON/OFF control.

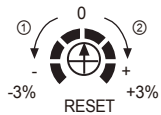

- ① Turn left when offset value is higher than setting value. (Direction ①)
- ② Turn right when offset value is lower than setting value. (Direction ②)

◎ Case detachment

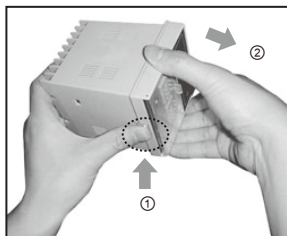

Pressing the front guide of Lock toward ① and squeeze and pull toward ②, it is detached.

◎ How to select control mode

Factory specification is P control. When using ON/OFF control, transfer the switch of control method from P to F after detaching the case from its body. When control output is current output, P control is fixed, there is no switch Pin of control method.

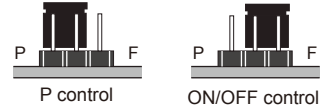

◎ Normal/Reverse operation

Reverse operation executes to output ON when process value is lower than setting value and it is used for heating. Normal operation runs conversely and is executed for cooling.

◎ Application of temperature controller and load connection

● SSR drive voltage output connection

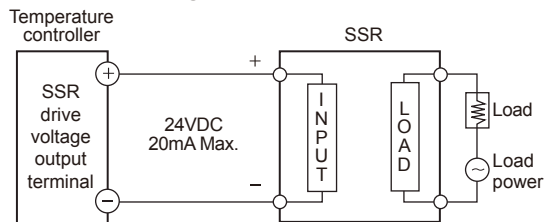

※ When using voltage (for driving SSR) in the other purposes, do not over the range of the rated current.

● Relay output connection

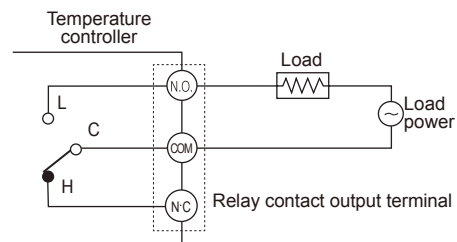

● Current output connection

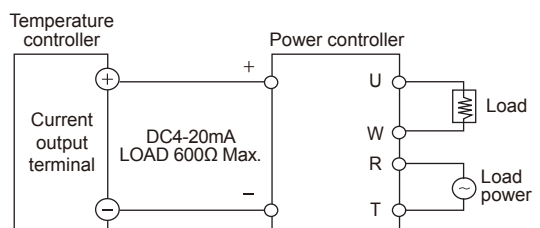

※ The current value of DC4-20mA is available at lower than 600Ω of resistive load.

※ Refer to the H-141 page for caution for using and simple error diagnosis.

Autonics