

# Paperless Recorder

## User's Manual



---

## **Preface**

Thank you for purchasing paperless recorder. Please read this manual carefully before operating and using it correctly to avoid unnecessary losses caused by false operation.

### **Note**

- Modification of this manual's contents will not be notified as a result of some factors, such as function upgrading.
- We try our best to guarantee that the manual content is accurate, if you find something wrong or incorrect, please contact us.
- This product is forbidden to use in explosion-proof occasions.

### **Version**

U-R1-MYEN4

---

## **Safety Precautions**

In order to use this product safely, be sure to follow the safety precautions described.

### **About this manual**

- Please submit this manual to the operator for reading.
- Please read the operation manual carefully before applying the instrument. On the precondition of full understanding.
- This manual only describes the functions of the product. The company does not guarantee that the product will be suitable for a particular use by the user.

### **Precautions for protection, safety and modification of this product**

- To ensure safe use of this product and the systems it controls, Please read carefully the operation manual and understand the correct application methods before putting into operation, to avoid unnecessary losses due to operation mistakes. If the instrument is operated in other ways not described in the manual, the protections that the instrument give may be destroyed, and the failures and accidents incurred due to violation of precautions shall not be borne by our company.
- When installing lightning protection devices for this product and its control system, or designing and installing separate safety protection circuits for this product and its control system, it needs to be implemented by other devices.
- If you need to replace parts of the product, please use the model specifications specified by the company.
- This product is not intended for use in systems that are directly related to personal safety. Such as nuclear power equipment, equipment using radioactivity, railway systems, aviation equipment, marine equipment, aviation equipment and medical equipment. If applied, it is the responsibility of the user to use additional equipment or systems to ensure personal safety.
- Do not modify this product.

- 
- The following safety signs are used in this manual:



Hazard, if not taken with appropriate precautions, will result in serious personal injury, product damage or major property damage.



Warning: Pay special attention to the important information linked to product or particular part in the operation manual.



- Confirm if the supply voltage is in consistent with the rated voltage before operation.
- Don't use the instrument in a flammable and combustible or steam area.
- To prevent from electric shock, operation mistake, a good grounding protection must be made.
- Thunder prevention engineering facilities must be well managed: the shared grounding network shall be grounded at is-electric level, shielded, wires shall be located rationally, SPD surge protector shall be applied properly.
- Some inner parts may carry high voltage. Do not open the square panel in the front except our company personnel or maintenance personnel acknowledged by our company, to avoid electric shock.
- Cut off electric powers before making any checks, to avoid electric shock.
- Check the condition of the terminal screws regularly. If it is loose, please tighten it before use.
- It is not allowed to disassemble, process, modify or repair the product without authorization, otherwise it may cause abnormal operation, electric shock or fire accident.
- Wipe the product with a dry cotton cloth. Do not use alcohol, benzine or other organic solvents. Prevent all kinds of liquid from splashing on the

---

product. If the product falls into the water, please cut off the power immediately, otherwise there will be leakage, electric shock or even a fire accident.

- Please check the grounding protection status regularly. Do not operate if you think that the protection measures such as grounding protection and fuses are not perfect.
- Ventilation holes on the product housing must be kept clear to avoid malfunctions due to high temperatures, abnormal operation, shortened life and fire.
- Please strictly follow the instructions in this manual, otherwise the product's protective device may be damaged.



- Don't use the instrument if it is found damaged or deformed at opening of package.
- Prevent dust, wire end, iron fines or other objects from entering the instrument during installation, otherwise, it will cause abnormal movement or failure.
- During operation, to modify configuration, signal output, startup, stop, operation safety shall be fully considered. Operation mistakes may lead to failure and even destruction of the instrument and controlled equipment.
- Each part of the instrument has a certain lifetime, which must be maintained and repaired on a regular basis for long-time use.
- The product shall be scrapped as industrial wastes, to prevent environment pollution.
- When not using this product, be sure to turn off the power switch.
- If you find smoke from the product, smell odor, abnormal noise, etc., please turn off the power switch immediately and contact the company in time.

---

## Disclaimer

- The company does not make any guarantees for the terms outside the scope of this product warranty.
- This company is not responsible for damage to the instrument or loss of parts or unpredictable damage caused directly or indirectly by improper operation of the user.

No.	Name	Quantity	Note
1	Paperless recorder	1	
2	Manual	1	
3	Certificate	1	
4	U disk	1	

After opening the box, please confirm the package contents before starting the operation. If you find that the model and quantity are incorrect or there is physical damage in appearance, please contact us.

---

# Contents

Chapter 1 Introduction.....	1
1.1. Main parameters.....	2
1.2. Input signal.....	3
1.3. Output signal.....	4
1.4. Other parameters.....	4
Chapter 2 Installation & Wiring.....	6
2.1 Unpacking.....	6
2.2 Installation.....	6
2.3 Wiring.....	8
2.3.1 Terminal introduction.....	8
2.3.2 Wiring diagram.....	12
Chapter 3 Basic Operation.....	13
3.1 Panel component.....	13
3.2 Navigation keys.....	13
3.2.1 Screen Operation.....	13
3.2.1 Configuration login.....	24
3.2.2 Enable configuration.....	25
3.2.3 Parameters & setting.....	26
Chapter 4 Configuration.....	32
4.1. Input Settings.....	32
4.1.1 Configuration Item: .....	32
4.1.2 Alarm setting screen.....	32
4.2. AO output.....	34
4.3. Flow setting.....	34
4.4. Accumulation setting.....	37
4.5. Control setting.....	38
4.6. Function setting.....	39
4.6.1 Zero clearing.....	39
4.6.2 U disk operation.....	39
4.6.3 Communication setting.....	40
4.6.4 Remote setting.....	41
4.6.5 Userdefined screen.....	43
4.7. System Settings.....	44
Appendix 1: Address and Examples of Modbus.....	45
Appendix 2: Calculation of flow coefficient K.....	48

## Chapter 1 Introduction



### Overview

The paperless recorder set various industrial, measurement data in civil applications, display, processing, computing, alarming, and recording a variety of reports and other functions in it. It has a 18-channel analog signal input channel, 4-channel relay alarm output channel, 150mA distribution output channel (which can be accessed 6-way two-wire transmitter, or 2-way four-wire transmitter), an RS-485 communication interface it has a USB data dump interface.

In hardware, the updated SUP-R9600 Paperless Recorder replaces the channel analog quantity input function with 4-channel analog quantity output and one RS-485 input function. In software, it adds 4-channel flow, 4-channel accumulation and 4-channel PID calculation function. Also, it includes a user-defined interface, which allows the user to arrange the channels in the interface at will.



---

**Comparison of function between updated recorder and basic recorder:**

Function	Basic type	Updated type
Analog quantity input	18 channels	1—12 channels
Analog quantity output	N/A	4 channels
Relay output	4 channels	4 channels
RS-485 output	Yes	Yes
RS-485 input	N/A	Yes
Power distribution	Yes	Yes
Flow (temperature and pressure compensation)	N/A	Yes
Accumulation	N/A	Yes
PID calculation	N/A	Yes
User-defined interface	N/A	Yes

The paperless recorder uses high-speed, high-performance 32-bit cortex-M4 microprocessor in its internal. Circuit board is handled through three anti-coating processes-----"anti-corrosion, anti-moisture, anti-dust". High-performance power meter has a strong anti-jamming capability and can effectively suppress external harmonic interference to improve the overall stability greatly.

The paperless recorder can be used in metallurgy, petroleum, chemicals, building materials, paper, electricity, food, pharmaceutical, industrial water treatment and other industries.

## 1.1. Main parameters

Table1-1 The main parameters

Screen size	3.5-inch TFT true color LCD screen. resolution is 320 * 240
Dimension	Dimension: 96mm×96mm×100mm Cutout dimension: 92mm×92mm
Panel thickness	1.5mm~6.0mm
Weight	0.37kg
Power supply	(176~264)VAC, 47~63Hz (24VDC can be customized)
Internal storage	48M bytes Flash
External storage	U disk support (standard USB2.0 communication interface)
Maximum power consumption	20VA
Relative humidity	(10~85)%RH (No condensation)
Operating temperature	(0~50)°C
Storage conditions	Temperature (-20~60)°C, Relative humidity (5~95)%RH (No condensation)

## 1.2. Input signal

Table1-2 DC voltage / current input

Type	The maximum allowed error (%FS)
(1~5) V	±0.1
(0~10) V	
(0~5) V	
(0~100) mV	
(4~20) mA	±0.2
(0~20) mA	
(0~10) mA	
(-20~20) mV	±0.25
(0~20) mV	

Table1-3 thermocouple input (not include cold junction error)

Type	Measure range (°C)	The maximum allowed error (°C)
B	600 ~ 1800	±2.4

E	-200 ~ 1000	±2.4
J	-200 ~ 1200	±2.4
K	-200 ~ -100	±3.3
	-100 ~ 1300	±2.0
S	-50 ~ 100	±3.7
	100 ~ 300	±2.0
	300 ~ 1600	±1.5
T	-200 ~ -100	±1.9
	-100 ~ 380	±1.6
R	-50 ~ 100	±3.7
	100 ~ 300	±2.0
	300 ~ 1600	±1.5
N	-200 ~ 1300	±3.0

Table1-4 RTD input

Type	Measure range (°C)	The maximum permissible error (°C)
Cu50	-50 ~ 140	±1.0
Pt100	-200 ~ 800	±1.0

NOTE: special RTD can be customized, like Pt1000 etc

### 1.3.Output signal

Table 1-5 The alarm output

Type	Scale range	Contact types	Contact capacity	Response cycle
The alarm output	0/1	Normally open contacts	2A /250VAC	1 second

Table 1-6 Current output

Type	Range (mA)	Maximum permissible error
Current output	4 ~ 20	±0.2

#### 1.4. Other parameters

Table 1-8 Other parameters

Fuse Specifications	3.15A/250VAC, Hard-fusing type
Power distribution specifications	150mA, 24 VDC.
Power failure protection	All data is stored in Flash storage to make sure that all historical data and configuration parameters are not lost due to power failure. The real-time clock powered by a lithium battery after power failure.
Alarm output	It has up to 4 channels. Relays are normally open contacts and the contact capacity is 2A / 250VAC (resistive load).
Communication Interface	1channel RS485 communication interface.one RS-485 input ( optional )
Communication protocol	Using Modbus communication protocol
Sampling period	1s

## Chapter 2 Installation & Wiring

This chapter describes the installation and wiring methods of this instrument. It is necessary for technicians to learn when they use the instrument for the first time.

This is a procedure which enables the instrument to normal operation, as the table

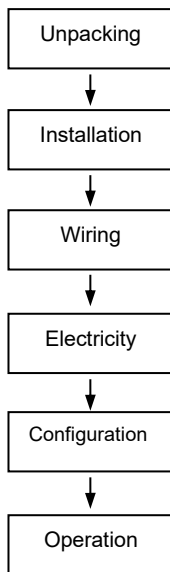

Figure 2-1 Flow diagram from unpacking to operation

### 2.1 Unpacking

Upon receipt of the instrument, Please check the packaging whether intact or not. Do not put excessive force to the box when unpacking the box. The box should be facing up opened from the seal. Remove the instrument from the box carefully to make sure the housing is not deformed, broken or cracked. You can check the packing list of the machine equipment and other items.

### 2.2 Installation

Instrument operating environment will not only affect the normal use of the instrument, but also affect the maintenance and calibration work. Instrumentation

environment should meet the following requirements:

- Indoor installation
- Operating temperature: (0~50)°C
- Relative humidity: (10~85)%RH (No condensation)
- Ventilation requirements: ventilated to prevent the internal meter temperature is too high
- Vibration disturbance: Less mechanical vibration
- Air ingredients: NOT easy to produce condensate, non-corrosive gas or flammable gas
- Inductive interference: no strong inductive interference, not easy to produce static electricity, magnetic fields or noise
- Meter position: When installing the instrument, try to maintain the level and do not tilt left and right

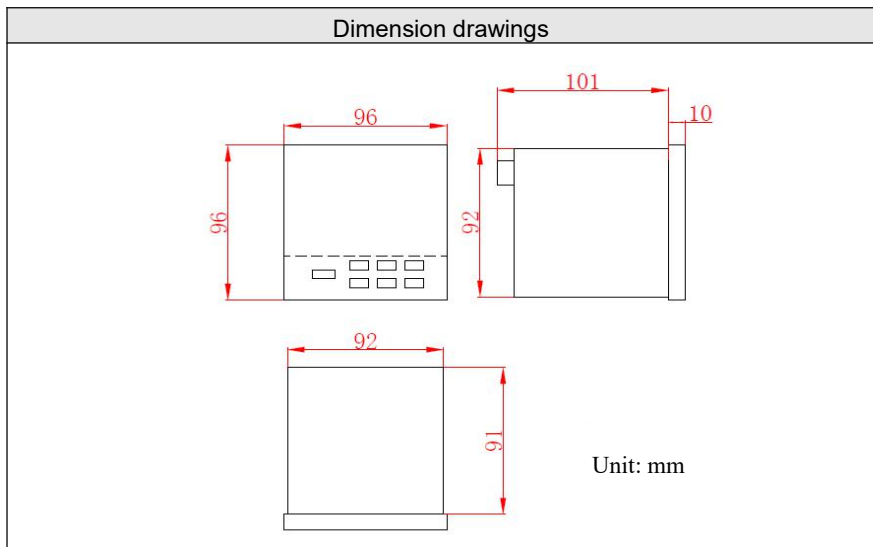

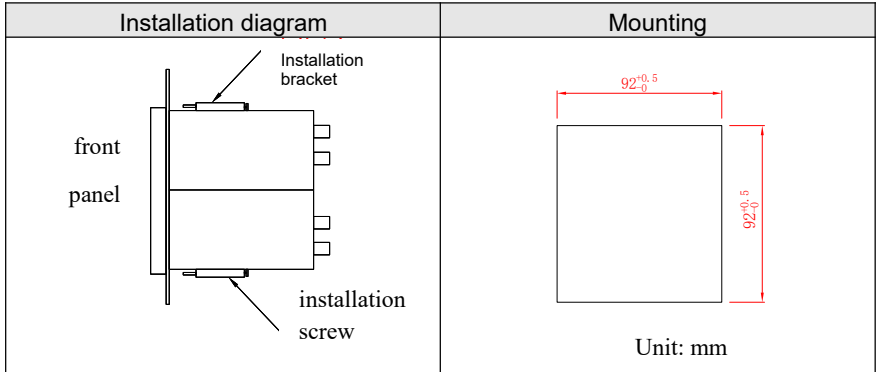

Figure 2-2 Product dimension and installation drawing

### 2.3 Wiring

In order to improve the stability and accuracy of the signals, it is recommended that you use the cold terminal signal cable to wire.

#### 2.3.1 Terminal introduction

Terminal arrangement is shown in figure 2-3、figure 2-4. Specific definition of terminal symbols and Explanation are described in figure 2-1.

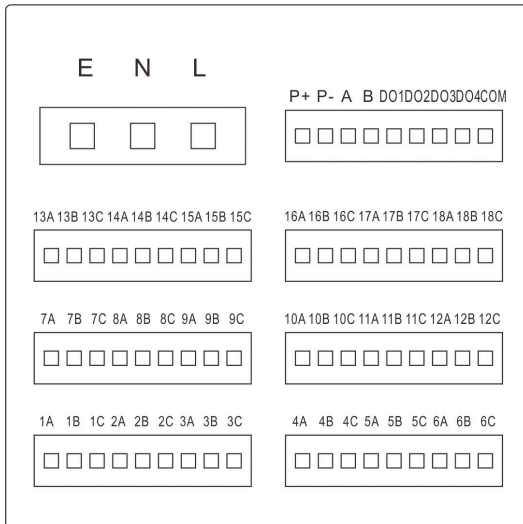

Figure 2-3 Terminal view of basic type

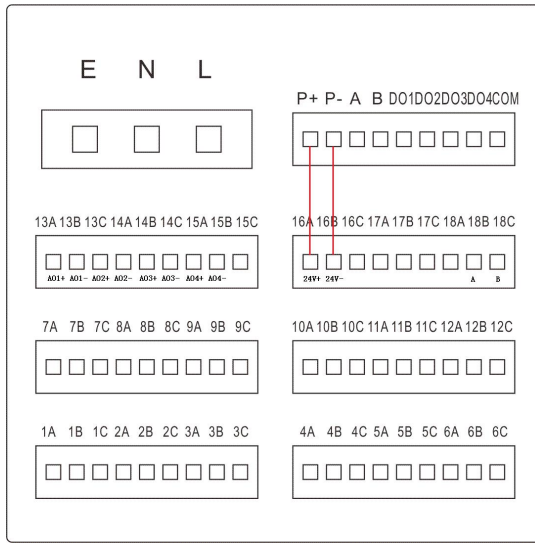

Figure 2-4 Terminal view of updated type

**NOTE:**

The analog quantity output board needs an external 24V power supply, which can be provided by the power adapter accompanied with the product. As the power is large, please do not power any other transmitter at this time.



Table2-1 Specific instructions of each terminal

Terminal No.	Signal type	Description
E、N、L	E、N、L	24VDC power supply: L is 24V+; N is 24V-; E is undefined. AC Power (single-phase three wire system) terminal block: L is Phase line terminals, N is Zero line terminals, E is Ground terminal.

**Signal input Terminal Description**

1A, 1B, 1C	universal input	analog input channel 1
2A, 2B, 2C	universal input	analog input channel2
3A, 3B, 3C	universal input	analog input channel 3
4A, 4B, 4C	universal input	analog input channel 4
5A, 5B, 5C	universal input	analog input channel 5
6A, 6B, 6C	universal input	analog input channel 6
7A, 7B, 7C	universal input	analog input channel 7
8A, 8B, 8C	universal input	analog input channel 8
9A, 9B, 9C	universal input	analog input channel 9
10A, 10B, 10C	universal input	analog input channel 10
11A, 11B, 11C	universal input	analog input channel 11
12A, 12B, 12C	universal input	analog input channel 12
13A, 13B, 13C	universal input	analog input channel 13
14A, 14B, 14C	universal input	analog input channel 14
15A, 15B, 15C	universal input	analog input channel 15
16A, 16B, 16C	universal input	analog input channel 16
17A, 17B, 17C	universal input	analog input channel 17
18A, 18B, 18C	universal input	analog input channel 18

**Signal output Terminal Description**

A	485+	communication port RS-485
---	------	---------------------------

Table2-1 Specific instructions of each terminal

Terminal No.	Signal type	Description
B	485-	communication port RS-485
Distribution output Terminal Description		

Table2-2 Specific instructions of each terminal

Terminal No.	Signal type	Description
P+	/	24V+
P-	/	24V-
Alarm output Terminal Description		
DO1	Relays	Alarm output Channel 1
DO2	Relays	Alarm output Channel 2
DO3	Relays	Alarm output Channel 3
DO4	Relays	Alarm output Channel 4
COM		Alarm Commons

Instructions for updated type terminal:

Terminal No.	Signal type	Description
13A, 13B	Current output	Analog quantity output of the first channel
13C, 14A	Current output	Analog quantity output of the second channel
14B, 14C	Current output	Analog quantity output of the third channel
15A, 15B	Current output	Analog quantity output of the fourth channel
16A, 16B	Power distribution input of the board	16A: 24V+, 16B: 24V-
18B, 18C	RS-485 input	18B: A, 18C: B

2.3.2 Wiring diagram

mA input (without power distribution)	mA input (with power distribution)
	
V/mV input	TC input
	
RTD input	
	

Figure 2-5 Schematic diagram of signal cable

## Chapter 3 Basic Operation





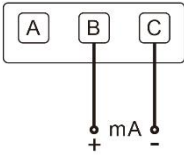
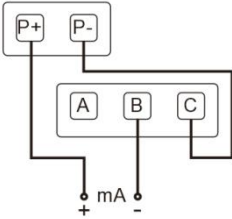
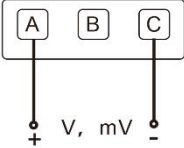
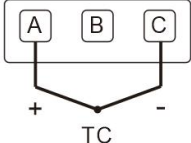
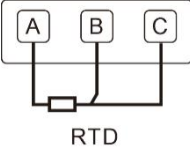



Figure 3-1 Panel component distribution

Panel component distribution of paperless recorder is shown in figure 3-1.



### 3.1 Panel component

- LCD Screen: Display monitor and configuration.
- key:

key	Name of key	key	Name of key
	Up		Right
	Down		Enter
	Left		Cancel

### 3.2 Navigation keys

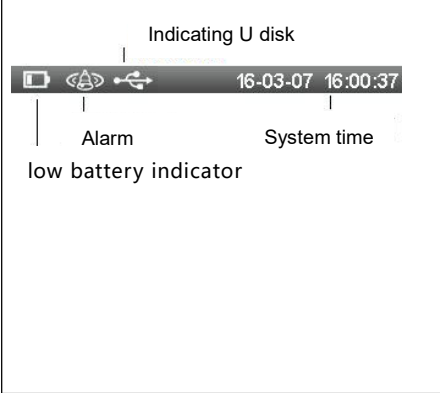
#### 3.2.1 Screen Operation

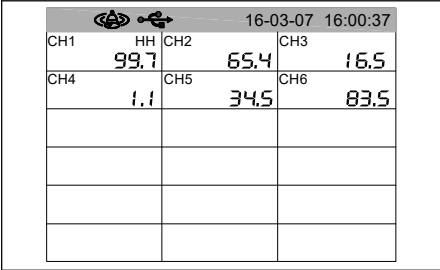
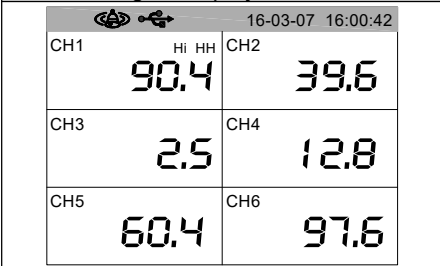
Information bar	Screen Description																												
 <p>low battery indicator</p> <p>Alarm</p> <p>System time</p> <p>Indicating U disk</p>	<ul style="list-style-type: none"> <li>● Battery Capacity:  Replace the batteries when there is such a sign, Pay attention to backup data before replacement</li> <li>● Alarm: When there is an alarm message appears, please enter the alarm screen to check it and then it will disappear.</li> <li>● U disk Tip: When insert U disk ,this sign will appear.</li> <li>● System time: Time of present system</li> </ul>																												
Front Panel	Screen Description																												
 <table border="1" data-bbox="168 750 520 1005"> <thead> <tr> <th>CH1</th> <th>HH</th> <th>CH2</th> <th>CH3</th> </tr> </thead> <tbody> <tr> <td>99.7</td> <td></td> <td>65.4</td> <td>16.5</td> </tr> <tr> <td>CH4</td> <td>1.1</td> <td>CH5</td> <td>34.5</td> </tr> <tr> <td></td> <td></td> <td></td> <td>83.5</td> </tr> <tr> <td></td> <td></td> <td></td> <td></td> </tr> <tr> <td></td> <td></td> <td></td> <td></td> </tr> <tr> <td></td> <td></td> <td></td> <td></td> </tr> </tbody> </table>	CH1	HH	CH2	CH3	99.7		65.4	16.5	CH4	1.1	CH5	34.5				83.5													<ul style="list-style-type: none"> <li>● Show all bit of analog input resolution, instantaneous value, units and alarm status</li> <li>● "XXXXX" represents the channel disconnection</li> <li>● You can switch the former and later picture through left key and right key.</li> </ul>
CH1	HH	CH2	CH3																										
99.7		65.4	16.5																										
CH4	1.1	CH5	34.5																										
			83.5																										
Digital display screen	Screen Description																												
 <table border="1" data-bbox="168 1053 520 1308"> <thead> <tr> <th>CH1</th> <th>Hi HH</th> <th>CH2</th> </tr> </thead> <tbody> <tr> <td>90.4</td> <td></td> <td>39.6</td> </tr> <tr> <td>CH3</td> <td>2.5</td> <td>CH4</td> </tr> <tr> <td></td> <td></td> <td>12.8</td> </tr> <tr> <td>CH5</td> <td>60.4</td> <td>CH6</td> </tr> <tr> <td></td> <td></td> <td>97.6</td> </tr> </tbody> </table>	CH1	Hi HH	CH2	90.4		39.6	CH3	2.5	CH4			12.8	CH5	60.4	CH6			97.6	<ul style="list-style-type: none"> <li>● Display channel bit number, the instantaneous value, units and alarm status.</li> <li>● Pressing up-key can switch channel.</li> <li>● You can switch the former and later picture through left key and right key.</li> </ul>										
CH1	Hi HH	CH2																											
90.4		39.6																											
CH3	2.5	CH4																											
		12.8																											
CH5	60.4	CH6																											
		97.6																											

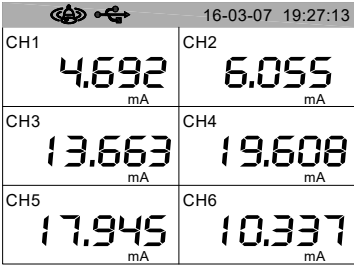
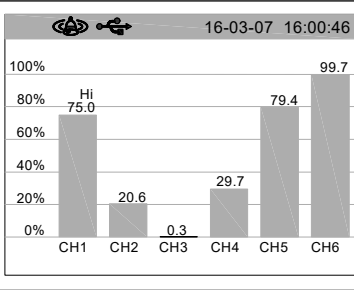
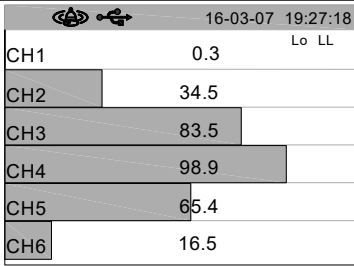
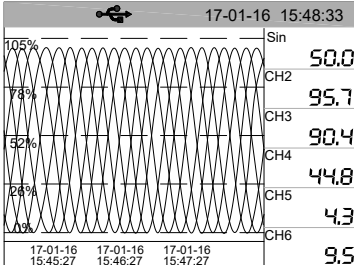
Digital display screen ( original signal )	Screen Description
	<ul style="list-style-type: none"> <li>● Display channel bit number, the instantaneous value of the original signal and the signal type.</li> <li>● Pressing up-key can switch channel.</li> <li>● You can switch the former and later picture through left key and right key.</li> </ul>
Bar graph screen ( vertical )	Screen Description
	<ul style="list-style-type: none"> <li>● Display channel bit number, the instantaneous value, units and alarm status.</li> <li>● Pressing up-key can switch channel.</li> <li>● You can switch the former and later picture through left key and right key.</li> </ul>
Bar graph screen ( horizontal )	Screen Description
	<ul style="list-style-type: none"> <li>● Display channel bit number, the instantaneous value, units and alarm status.</li> <li>● Pressing up-key can switch channel.</li> <li>● You can switch the former and later picture through left key and right key.</li> </ul>
Real-time curve interface	Screen Description
	<ul style="list-style-type: none"> <li>● Real-time curve display: Channel number, instantaneous value</li> <li>● Press Addition key can switch channels.</li> <li>● Press Left/Right key can switch the previous and the current interfaces.</li> </ul>

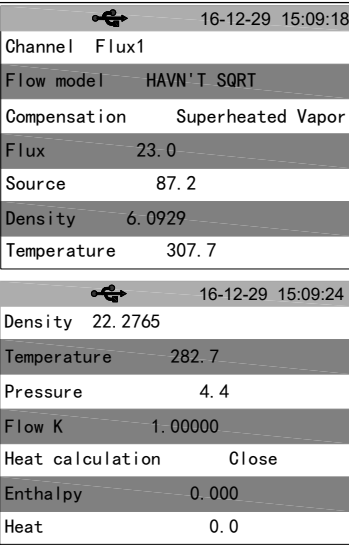
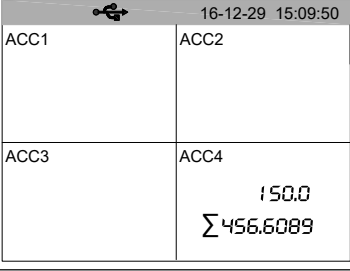
Flow interface	Screen Description																												
 <p>16-12-29 15:09:11</p> <table border="1"> <tr> <td>Flux1</td> <td>Flux2</td> </tr> <tr> <td>106.6</td> <td></td> </tr> <tr> <td>Flux3</td> <td>Flux4</td> </tr> <tr> <td></td> <td>0.0</td> </tr> </table>	Flux1	Flux2	106.6		Flux3	Flux4		0.0	<ul style="list-style-type: none"> <li>● Display items of flow channel: channel number, instantaneous value, unit and alarm state.</li> <li>● Press Left/Right key can switch the previous and the current interfaces.</li> </ul>																				
Flux1	Flux2																												
106.6																													
Flux3	Flux4																												
	0.0																												
 <p>16-12-29 15:09:18</p> <table border="1"> <tr><td>Channel</td><td>Flux1</td></tr> <tr><td>Flow model</td><td>HAVN'T SQRT</td></tr> <tr><td>Compensation</td><td>Superheated Vapor</td></tr> <tr><td>Flux</td><td>23.0</td></tr> <tr><td>Source</td><td>87.2</td></tr> <tr><td>Density</td><td>6.0929</td></tr> <tr><td>Temperature</td><td>307.7</td></tr> </table> <p>16-12-29 15:09:24</p> <table border="1"> <tr><td>Density</td><td>22.2765</td></tr> <tr><td>Temperature</td><td>282.7</td></tr> <tr><td>Pressure</td><td>4.4</td></tr> <tr><td>Flow K</td><td>1.00000</td></tr> <tr><td>Heat calculation</td><td>Close</td></tr> <tr><td>Enthalpy</td><td>0.000</td></tr> <tr><td>Heat</td><td>0.0</td></tr> </table>	Channel	Flux1	Flow model	HAVN'T SQRT	Compensation	Superheated Vapor	Flux	23.0	Source	87.2	Density	6.0929	Temperature	307.7	Density	22.2765	Temperature	282.7	Pressure	4.4	Flow K	1.00000	Heat calculation	Close	Enthalpy	0.000	Heat	0.0	<ul style="list-style-type: none"> <li>● Press Addition key can switch and check detailed information of the channel.</li> <li>● Allow check of more parameters: temperature, pressure and density ,etc.</li> <li>● Continue to press Addition key to return to the initial state.</li> </ul>
Channel	Flux1																												
Flow model	HAVN'T SQRT																												
Compensation	Superheated Vapor																												
Flux	23.0																												
Source	87.2																												
Density	6.0929																												
Temperature	307.7																												
Density	22.2765																												
Temperature	282.7																												
Pressure	4.4																												
Flow K	1.00000																												
Heat calculation	Close																												
Enthalpy	0.000																												
Heat	0.0																												
Accumulation interface	Screen Description																												
 <p>16-12-29 15:09:50</p> <table border="1"> <tr> <td>ACC1</td> <td>ACC2</td> </tr> <tr> <td></td> <td></td> </tr> <tr> <td>ACC3</td> <td>ACC4</td> </tr> <tr> <td></td> <td>150.0</td> </tr> <tr> <td></td> <td>Σ 456.6089</td> </tr> </table>	ACC1	ACC2			ACC3	ACC4		150.0		Σ 456.6089	<ul style="list-style-type: none"> <li>● Display instantaneous value and total accumulation value at the same time.</li> <li>● Press Left/Right key can switch the previous and the current interfaces.</li> </ul>																		
ACC1	ACC2																												
ACC3	ACC4																												
	150.0																												
	Σ 456.6089																												

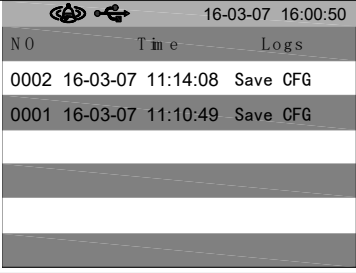
Log screen	Screen Description
	<ul style="list-style-type: none"> <li>● Display the log information.</li> <li>● Pressing up-key can switch channel.</li> <li>● You can switch the former and later picture through left key and right key.</li> </ul>

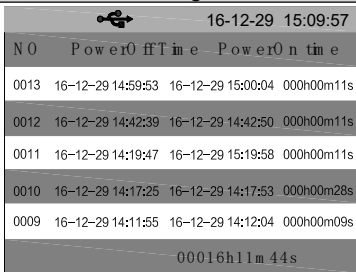

Power off safeguard screen	Screen Description
	<ul style="list-style-type: none"> <li>● Display power off time and power on time and cumulative time of power off.</li> <li>● Pressing up-key can switch channel.</li> <li>● You can switch the former and later picture through left key and right key.</li> </ul>

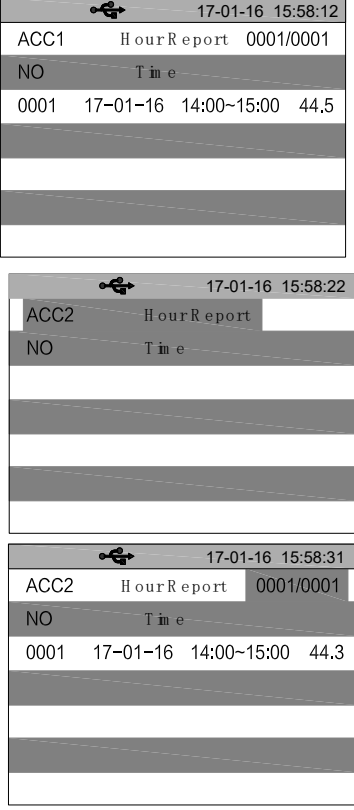
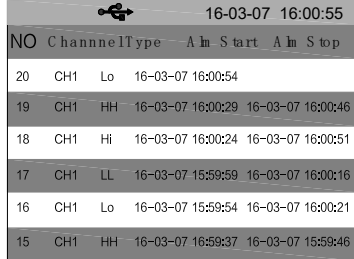

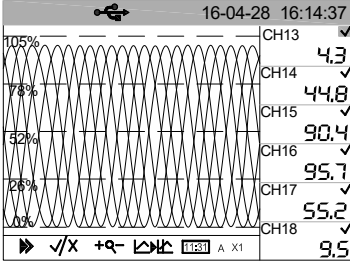
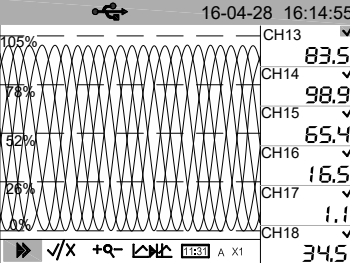
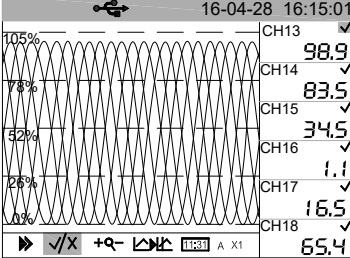
Report interface	Screen Description																																			
 <p>The screenshots show the Report interface for three different channels: ACC1, ACC2, and ACC2. Each screen displays the channel name, report type (Hour Report), and a summary of data including a 'NO Time' field and a numerical value.</p>	<ul style="list-style-type: none"> <li>● Display accumulation time report.</li> <li>● Press Addition key can switch the location of blue cursor.</li> <li>● Allow switch of previous and the current interface and channel.</li> </ul>																																			
Alarm screen	Screen Description																																			
 <p>The Alarm screen displays a table of alarm events. The columns are: NO, Channel, Type, Alarm Start, and Alarm Stop. The data rows are as follows:</p> <table border="1" data-bbox="171 1082 519 1302"> <thead> <tr> <th>NO</th> <th>Channel</th> <th>Type</th> <th>Alm Start</th> <th>Alm Stop</th> </tr> </thead> <tbody> <tr> <td>20</td> <td>CH1</td> <td>Lo</td> <td>16-03-07 16:00:54</td> <td></td> </tr> <tr> <td>19</td> <td>CH1</td> <td>HH</td> <td>16-03-07 16:00:29</td> <td>16-03-07 16:00:46</td> </tr> <tr> <td>18</td> <td>CH1</td> <td>Hi</td> <td>16-03-07 16:00:24</td> <td>16-03-07 16:00:51</td> </tr> <tr> <td>17</td> <td>CH1</td> <td>LL</td> <td>16-03-07 15:59:59</td> <td>16-03-07 16:00:16</td> </tr> <tr> <td>16</td> <td>CH1</td> <td>Lo</td> <td>16-03-07 15:59:54</td> <td>16-03-07 16:00:21</td> </tr> <tr> <td>15</td> <td>CH1</td> <td>HH</td> <td>16-03-07 16:59:37</td> <td>16-03-07 16:59:46</td> </tr> </tbody> </table>	NO	Channel	Type	Alm Start	Alm Stop	20	CH1	Lo	16-03-07 16:00:54		19	CH1	HH	16-03-07 16:00:29	16-03-07 16:00:46	18	CH1	Hi	16-03-07 16:00:24	16-03-07 16:00:51	17	CH1	LL	16-03-07 15:59:59	16-03-07 16:00:16	16	CH1	Lo	16-03-07 15:59:54	16-03-07 16:00:21	15	CH1	HH	16-03-07 16:59:37	16-03-07 16:59:46	<ul style="list-style-type: none"> <li>● Display alarm channel, type, beginning and ending time of alarm.</li> <li>● Pressing up-key can switch channel.</li> <li>● You can switch the former and later picture through left key and right key.</li> </ul>
NO	Channel	Type	Alm Start	Alm Stop																																
20	CH1	Lo	16-03-07 16:00:54																																	
19	CH1	HH	16-03-07 16:00:29	16-03-07 16:00:46																																
18	CH1	Hi	16-03-07 16:00:24	16-03-07 16:00:51																																
17	CH1	LL	16-03-07 15:59:59	16-03-07 16:00:16																																
16	CH1	Lo	16-03-07 15:59:54	16-03-07 16:00:21																																
15	CH1	HH	16-03-07 16:59:37	16-03-07 16:59:46																																

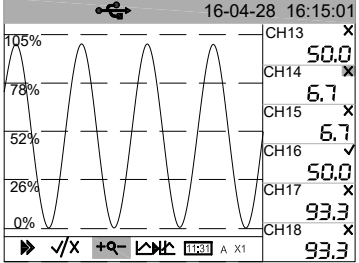
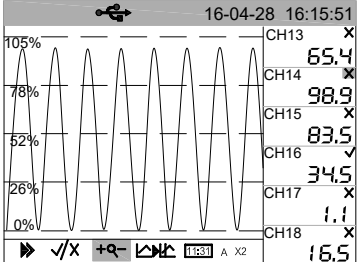
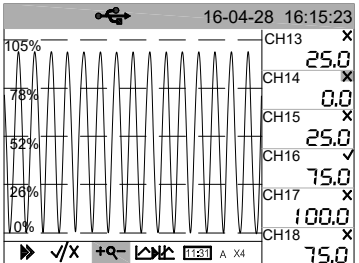
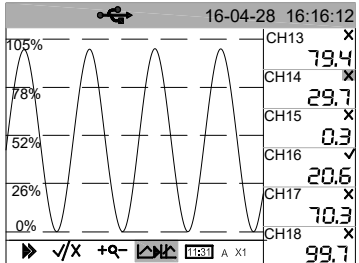
History screen	Screen Description
	<ul style="list-style-type: none"> <li>● The historic interface includes two modes: real-time mode and historic mode.</li> <li>● Under real-time mode, the data will be refreshed according to record intervals. Historic mode is a query mode under which relevant historic data will be displayed according to the input time.</li> <li>● Press Addition key can switch of status.</li> <li>● You can switch the former and later picture through left key and right key.</li> </ul>
History screen-1	Screen Description
	<ul style="list-style-type: none"> <li>● Pressing Addition key reaches channel switch status first.</li> <li>● Press Left/Right key can switch channels, continue to press Addition key to switch to the next state.</li> </ul>
History screen-2	Screen Description
	<ul style="list-style-type: none"> <li>● Press Addition key again to switch to blanking state.</li> <li>● At this time, press Left/Right key to select channels to be blanked.</li> <li>● Press Confirmation key to blank or display the selected curve.</li> </ul>

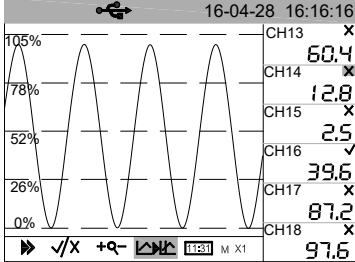
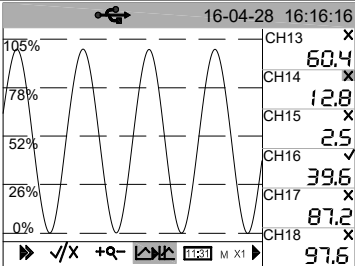
History screen-3	Screen Description
 <p style="text-align: center;">One time</p>  <p style="text-align: center;">Two times</p>  <p style="text-align: center;">Four times</p>	<ul style="list-style-type: none"> <li>● Press Addition key again to switch to the zoom state.</li> <li>● Press Left/Right key can change the displayed times. There are three choices of 1,2,4 times. Continue to press Addition key to switch to the next state.</li> </ul>
History screen-4	Screen Description
 <p style="text-align: center;">Auto mode state: A</p>	<ul style="list-style-type: none"> <li>● Press Addition key again to switch to real-time/historic mode switch state.</li> <li>● At this time, Left/Right key can change the real-time mode and historic mode state, continue to press Addition key to switch to the next state.</li> </ul>

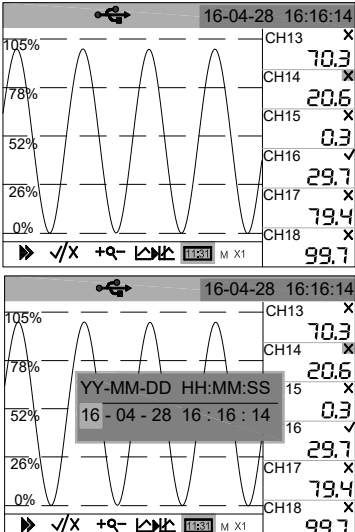
 <p>Historic mode state: M</p>	
 <p>History screen-5</p>	<p>Screen Description</p> <ul style="list-style-type: none"> <li>● Under historic mode, press Addition key to switch to manual query mode (An arrow  occurs).</li> <li>● At this time, Left/Right key enable check of previous and current historic data value. Press and hold this key can move quickly.</li> <li>● Continue to press Addition key to switch to the next state.</li> </ul>
 <p>History screen-6</p>	<p>Screen Description</p> <ul style="list-style-type: none"> <li>● Press Addition key again to switch to query mode of fixed point.</li> <li>● At this time, if pressing Confirmation key, time setting will pop up.</li> <li>● Set the time and press Confirmation key, then you can perform query.</li> <li>● Press Addition key again to exit operation state in historic state.</li> </ul>

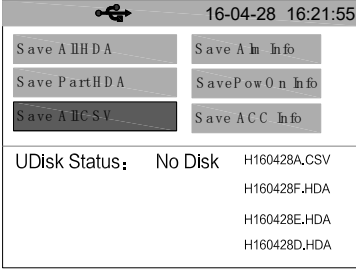
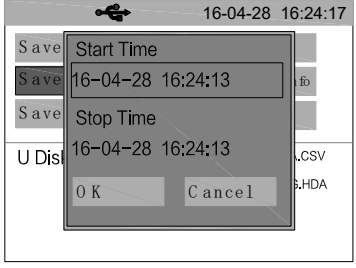
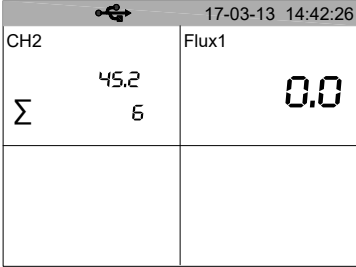
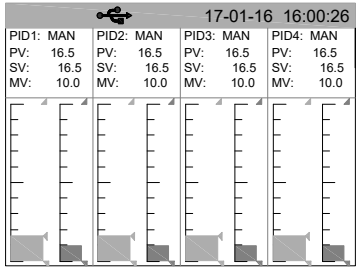
Data save interface	Screen Description
	<ul style="list-style-type: none"> <li>● Can save historic data. With HDA and CSV format available (You can check it at a host computer). Records pertaining to alarms, power loss, logs, can be saved in CSV format. (NOTE 1)</li> <li>● The saved data is displayed on the lower right part for ease of check.</li> </ul>
Data save interface-1	Screen Description
	<ul style="list-style-type: none"> <li>● Setting start time and end time can save part of historic data in HDA format.</li> </ul>
user-defined interface	Screen Description
	<ul style="list-style-type: none"> <li>● Channel of user-defined interface is customized. If not, then it's unavailable.</li> <li>● You can switch the former and later picture through left key and right key.</li> </ul>
PID overview	Screen Description
	<ul style="list-style-type: none"> <li>● The bar graph displays 4-channel PID measurement value, setting value, output value and manual/auto state.</li> </ul>

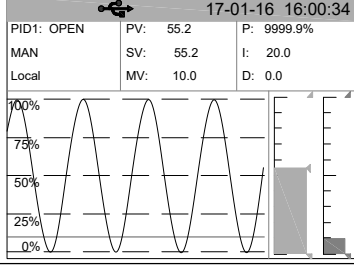
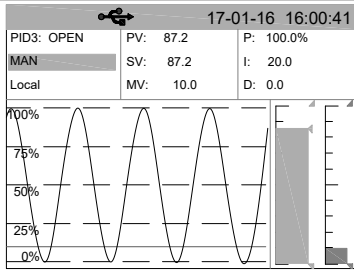
PID debugging	Screen Description
 <p>PID1: OPEN PV: 55.2 P: 9999.9%  MAN SV: 55.2 I: 20.0  Local MV: 10.0 D: 0.0</p>	<ul style="list-style-type: none"> <li>● Show PID loop information in detail, including PID parameters to facilitate debugging.</li> </ul>
 <p>PID3: OPEN PV: 87.2 P: 100.0%  MAN SV: 87.2 I: 20.0  Local MV: 10.0 D: 0.0</p>	<ul style="list-style-type: none"> <li>● Press Addition key can switch the location of gray cursor, Left/Right key modifies the channel, manual/auto state, setting value/output value and given internal and external state. PID parameter cannot be modified.</li> </ul>

**【Note 1】 : File saving path**

Files of this recorder are all saved in relevant folders corresponding to the root directory (recorder name). The recorder name can be modified in “system setting” configuration.

**File name:**

Document	Subdirectory	File name
Historic record	/History	H160109A.csv/ H160109A.hda
Accumulation record	/Info	A160109A.csv
Alarm information	/Info	B160109A.csv
Power off record	/Info	P160109A.csv
Log record	/Info	L160109A.csv



**Where:**

The initial letter H、A、B、P、L denotes file type. The six numbers that follow represent the saved date. The last letter can be A~Z, indicating that a type can be saved for 26 times a day. If it's full, then the no files can be saved.

**Tips:**

After inserting a U disk, it the system identifies such disk, it will automatically transfer and save the data into the U disk at exactly 2 o'clock every day.

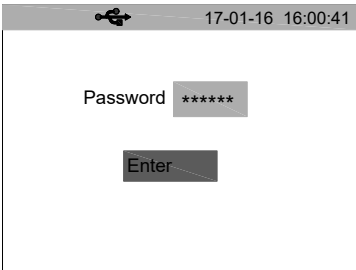
### 3.2.1 Configuration login

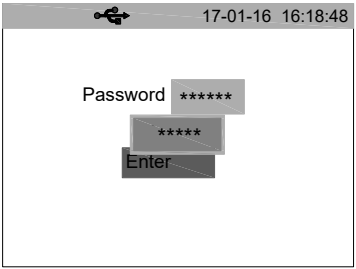
Step	Interface	Operation
1	 <p>The screenshot shows a terminal window with a title bar containing a mouse cursor icon and the date/time '17-01-16 16:00:41'. The main content area displays 'Password *****' followed by a cursor. Below it is an 'Enter' key graphic.</p>	<ul style="list-style-type: none"> <li>● Under the left interface, press and hold  and  key to enter login interface.</li> </ul>
2	 <p>The screenshot shows a terminal window with a title bar containing a mouse cursor icon and the date/time '17-01-16 16:18:48'. The main content area displays 'Password *****' followed by a cursor. Below it is another 'Password *****' field with a cursor, and an 'Enter' key graphic.</p>	<ul style="list-style-type: none"> <li>● Press Left/Right key to switch the location of the cursor, and press Confirmation key to enter configuration or input password.</li> <li>● When entering the password, pressing Addition/deletion key to modify the password. Left/Right key can modify the location of numbers. Pressure Confirmation key for confirmation of the input.</li> </ul>
3		<ul style="list-style-type: none"> <li>● Confirm the correct password, select enter configuration and press Confirmation key to login.</li> </ul>

## 3.2.2 Enable configuration

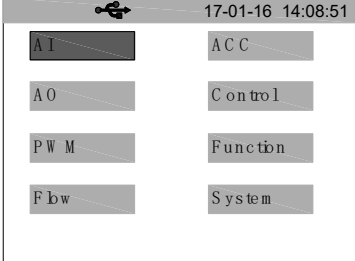
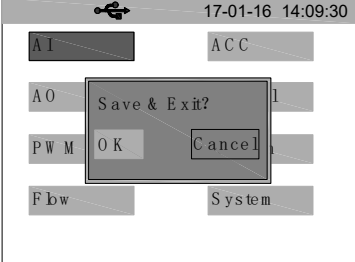
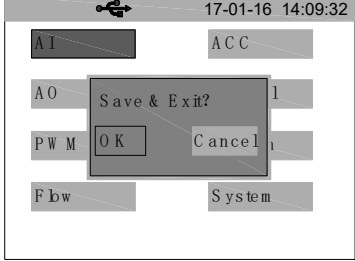
Step	Interface	Operation
1		<ul style="list-style-type: none"> <li>● After completing modification, press Cancel key until the configuration interface appears.</li> </ul>
2		<ul style="list-style-type: none"> <li>● Press Cancel key again. If the configuration is modified, a confirmation dialog box will appear. If not, enter the monitoring interface directly.</li> </ul>
3		<ul style="list-style-type: none"> <li>● Select "OK" and press Confirmation key. NOTE: The cursor selects "Cancel" by default.</li> </ul>



### 3.2.3 Parameters & setting

#### Digital input

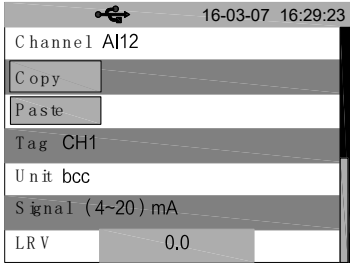
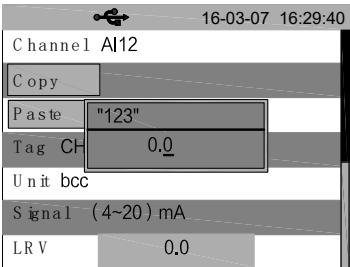
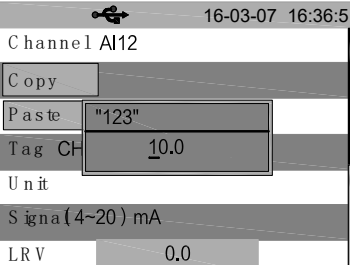
Step	Interface	Operation
1		<ul style="list-style-type: none"> <li>● Select the parameter to be modified, and press Confirmation key.</li> </ul>
2		<ul style="list-style-type: none"> <li>● Left/Right key can select the parameter location to be modified.</li> </ul>
3		<ul style="list-style-type: none"> <li>● Addition/Deletion key can modify the numbers at the selected location.</li> </ul>

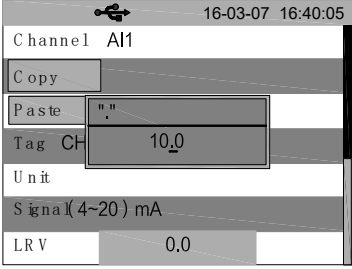
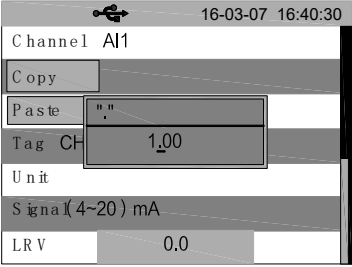
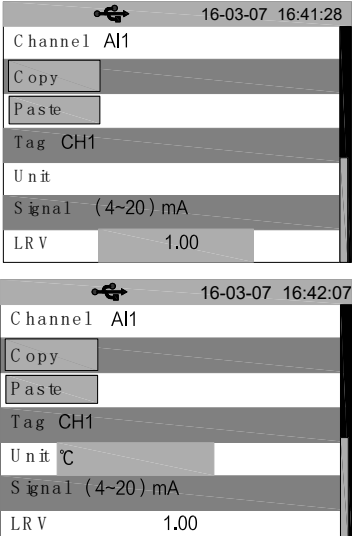
Step	Interface	Operation
4		<ul style="list-style-type: none"> <li>● After entering, press Confirmation key to adjust the decimal point.</li> </ul>
5		<ul style="list-style-type: none"> <li>● Left/Right key can modify the location of decimal point.</li> </ul>
6		<ul style="list-style-type: none"> <li>● Press Confirmation key again to complete numerical entering.</li> <li>● Press Cancel key to cancel the modification.</li> </ul>

**Input of bit channel No. and unit**

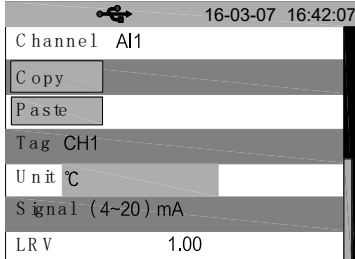
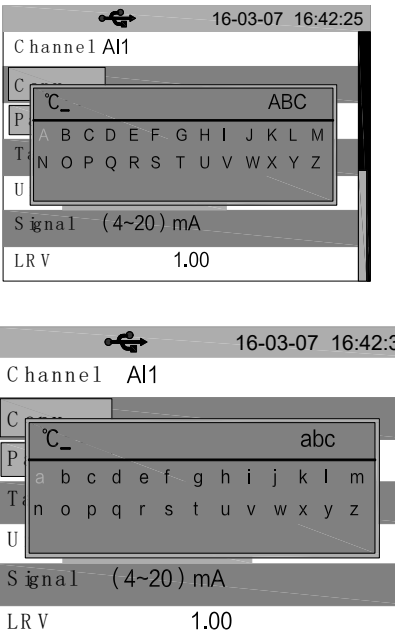
Step	Interface	Operation
1		<ul style="list-style-type: none"> <li>● Select the parameter to be modified, and press Confirmation key.</li> </ul>
2		<ul style="list-style-type: none"> <li>● Press Addition key can switch the type of input character.</li> </ul>

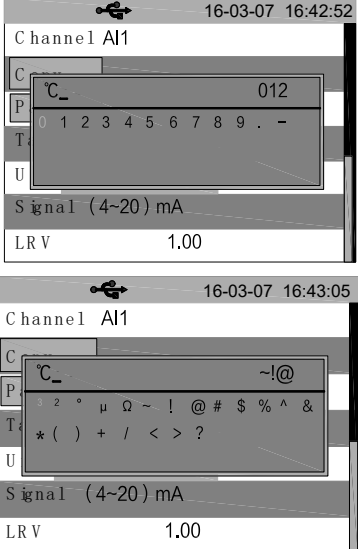
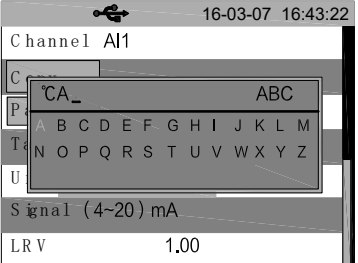
Step	Interface	Operation
	 <p>The first screenshot shows the 'Channel A1' screen with a numeric keypad overlay. The keypad has digits 0-9, a decimal point, and a minus sign. The display shows '°C_' and '012'. Below the keypad, it says 'Signal (4~20) mA' and 'LRV 1.00'. The timestamp is '16-03-07 16:42:52'.</p> <p>The second screenshot shows the same 'Channel A1' screen with a special character keypad overlay. The keypad includes symbols like °, μ, Ω, ~, !, @, #, \$, %, ^, &amp;, *, (, +, /, &lt;, &gt;, ?. The display shows '°C_' and '~!@'. Below the keypad, it says 'Signal (4~20) mA' and 'LRV 1.00'. The timestamp is '16-03-07 16:43:05'.</p>	
<p>3</p>	 <p>The screenshot shows the 'Channel A1' screen with a full alphanumeric keypad overlay. The keypad has letters A-Z and numbers 0-9. The display shows '°CA_' and 'ABC'. Below the keypad, it says 'Signal (4~20) mA' and 'LRV 1.00'. The timestamp is '16-03-07 16:43:22'.</p>	<ul style="list-style-type: none"> <li>● Press Left/Right key can select the input character.</li> <li>● Press Confirmation key for confirmation.</li> <li>● Press Deletion key to delete input.</li> <li>● Press Cancel key to exit.</li> </ul>

**Choice box**

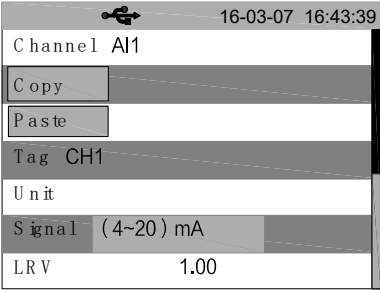
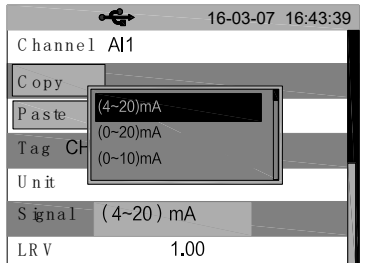
Step	Interface	Operation
1		<ul style="list-style-type: none"> <li>● Select the parameter to be modified, and press Confirmation key.</li> </ul>
2		<ul style="list-style-type: none"> <li>● Left/Right key can select items.</li> <li>● Confirmation key saves the items and exits.</li> <li>● Cancel key cancels and exits.</li> </ul>

**System time**

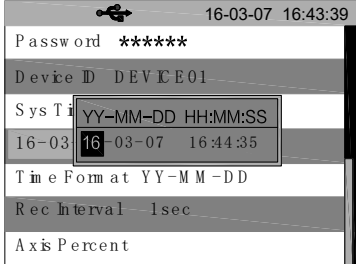
Step	Interface	Operation
1		<ul style="list-style-type: none"> <li>● Select the parameter to be modified, and press Confirmation key.</li> <li>● Left/Right key can select location.</li> <li>● Addition/Deletion key can modify numbers (letters).</li> <li>● Confirmation key saves the items and exits, cancel key cancels and exits.</li> </ul>

**Recorder name**

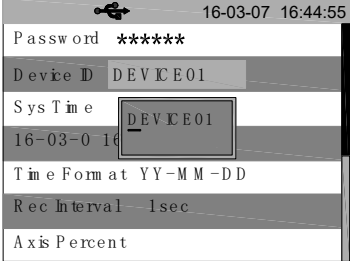
Step	Interface	Operation
1		<ul style="list-style-type: none"> <li>● Select the parameter to be modified, and press Confirmation key.</li> <li>● Left/Right key can select location.</li> <li>● Addition/Deletion key can modify numbers (letters).</li> <li>● Confirmation key saves the items and exits, cancel key cancels and exits.</li> </ul>

Tips: Under Input setting mode, the channel can be switched by Addition/Deletion key

## Chapter 4 Configuration

This chapter introduces the individual configuration parameters of instrument.

### 4.1. Input Settings

#### 4.1.1 Configuration Item:

configuration Item	Function Description	Parameter range
Channel	Select set analog channel	AI1~AI18(The real display shall prevail.)
Copy	Copy the configuration	
Paste	Paste the copied configuration information	
Bit	Set bit of the analog channel	Custom string's length is 8
Unit	Set the unit for analog channel	Custom string's length is 8
Signal	Setting Signal Types	(4~20) mA、(0~20) mA、(0~10) mA、PT100、Cu50、(1~5) V、(0~10) V、(0~5) V、B、E、J、K、S、T、R、N、(0~20) mV、(-20~20) mV、(0~100) mV
Lower Range limit	Set lower Range limit	-99999~99999
Upper Range limit	Set upper range limit	-99999~99999
Correction factor A	A in $Y=A*X+B$	-99999~99999
Correction factor B	B in $Y=A*X+B$	-99999~99999
First-order filter	First-order filter parameter	0s, 1s, 2s, 5s, 10s, 15s, 30s
Disconnection display	Displays the value of channel disconnection	-99999~99999
Alarm setting	Enter to alarm setting screen.	

### 4.1.2 Alarm setting screen

configuration Item	Function Description	Parameter range
Higher alarm HH	Higher alarm value	-99999~99999
Higher alarm output	Higher alarm output terminal	None、DO1、DO2、DO3、DO4 (The real display shall prevail.)
High alarm Hi	High alarm value	-99999~99999
High alarm output	High alarm output terminal	None、DO1、DO2、DO3、DO4 (The real display shall prevail.)
Low alarm Lo	Low alarm value	-99999~99999
Low alarm output	Low alarm output terminal	None、DO1、DO2、DO3、DO4 (The real display shall prevail.)
Lower alarm LL	Lower alarm value	-99999~99999
Lower alarm output	Lower alarm output terminal	None、DO1、DO2、DO3、DO4 (The real display shall prevail.)
Hysteresis	Alarm Hysteresis	-99999~99999

Note: Hysteresis prevents repeated alarm when the measures date fluctuates from the alarm point. The high- or low-level alarm and Hysteresis figure is showed in Figure 4-1 below. At high level alarm, when the actual engineering value is larger than or equal to the alarm value, the recorder enters into the alarm state. When the input is reduced, the actual engineering value is less than the alarm value, but the recorder will not exit the alarm state immediately. Until the actual engineering value is less than the alarm value and Hysteresis value, will the recorder exit the alarm state. The same is for low level alarm.



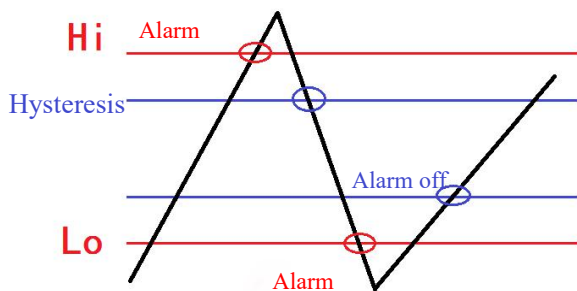

Figure 4-1: High- or low-level alarm and Hysteresis

## 4.2. AO output

The current output module provides 4 independent 4~20 mA current output. It can output measurement value, flow value and PID calculation value. It can also achieve transferring output and PID control function.

Configuration Item Description:

configuration Item	Function Description	Parameter range
Channel	Select AO channel	AO1~AO4
State	Enable/Disenable this channel	Enable/Disenable
Signal source	Channel to be output	AI1~AI12、FLOW1~FLOW4、PID1~PID4、VA1~VA4 【Note 1】
Signal type	Output analog quantity type	(4~20) mA 【Note 2】
Lower limit of range	Lower limit of channel	-99999~99999
Upper limit of range	Upper limit of channel	-99999~99999
Zero-mark calibration mA	Can be slightly adjusted in mA.	-5mA~5mA

【Note 1】 :

VA is the special channel defined by the user. If you have not defined this channel, please ignore it.

【Note 2】 :

$$\text{Current output} = \frac{\text{Signal source} - \text{Lower limit of range}}{\text{Upper limit of range} - \text{Lower limit of range}} * 16\text{mA} + 4\text{mA} + \text{Zero mark calibration}$$

### 4.3. Flow setting

The flow function can be used to measure such medium as superheated steam, saturated steam, general gas, mixed gas, natural gas, coal gas, water, hot water, chemical liquidness. It's applicable to be used with the vortex flowmeter, turbine flowmeter, V-cone flowmeter, elbow flowmeter, electromagnetic flowmeter, mass flowmeter, orifice flowmeter, nozzle flowmeter, classic venturi and other flow products.

Configuration Item Description:

configuration Item	Function Description	Parameter range
Channel	Select flow channel	FLOW1~FLOW4
State	Enable/Disenable this channel	Enable/Disenable
Unit	The display unit in flow interface	User-defined 8-bit character string
Signal source	Channel of flow signal	AI1~AI18 【Note1】
Lower limit of range	Lower limit of range after flow compensation	-99999~99999
Upper limit of range	Upper limit of range after flow compensation	-99999~99999
Flow model	Select formula suitable for restriction choke	No extraction of a root、 No extraction of a root for differential pressure、 Extraction of a root for differential pressure 【Note 2】
Signal removal	Removal of small flow	-99999~99999
Flow coefficient	K in the formula 【Note 2】	-100000000~100000000
Compensation mode	Select algorithm of density compensation	Given density, superheated steam, saturated steam P, saturated steam T, general gas, without compensation, temperature linear compensation, pressure

		linear compensation 【Note 3】
Pressure signal	P in density compensation in MPa	None、A11~A118 【Note 1】
Emergency pressure	Emergency value in case of abnormal pressure	-100000000~100000000
Temperature signal	T in density compensation in °C	None、A11~A118 【Note 1】
Emergency temperature	Emergency value in case of abnormal temperature	-100000000~100000000
Linear compensation A	Use in Note 3	-100000000~100000000
Linear compensation B	Use in Note 3	-100000000~100000000
Heat calculation	Select the model for heat calculation	Close, give enthalpy, auto calculation 【Note 4】
Given enthalpy	Used when selecting a given enthalpy	-100000000~100000000
Alarm setting	Enter alarm setting interface	

【Note 1】 :When mode A or remote Modbus input is selected, only A11~A112 is available.

【Note 2】 : Methods for calculating flow are various, such as throttling model, speed model, pulse frequency model, volumetric model, mass model, and so on.

In this recorder, three types of methods are concluded:

Flow model	Formula
No extraction of a root	$Q = K * I_f * \rho$
No extraction of a root for differential pressure	$Q = K * \sqrt{\Delta P} * \rho$
Extraction of a root for differential pressure	$Q = K * \Delta P * \sqrt{\rho}$

#### Where:

Q: Mass flow rate

K: Flow coefficient

$\rho$  : Fluid density

$\Delta P$ : Differential pressure signal

If : Flow value of restriction choke. It may be a current signal or a frequency signal.

【Note 3】 : It can be seen from the flow model that the calculation of mass flow is directly related with the fluid density. As the gas density varies greatly with the operating conditions, the calculation of the working density is required. The table below is the calculation method for setting different gas densities.

【Note 4】 :

$$Q_{\text{heat}} = K_{\text{heat}} * Q * H$$

**Where:**

Q<sub>heat</sub>: Heat flow rate

K<sub>heat</sub>: Heat flow rate coefficient (The coefficient of enthalpy of this recorder is 1)

Q: Mass flow rate

H: Enthalpy

#### 4.4. Accumulation setting

The accumulation function accumulates selected signal sources in terms of hour, day, and month, which forms a time report, a daily report, and a monthly report.

Compensation mode	Calculation method	Applicable fluid
Given density	$\rho$ Calculate as per given density	Liquid
Superheated steam	$\rho$ Calculate as per IAPWS-IF97	Superheated steam
Saturated steam P	$\rho$ Calculate through pressure as per IAPWS-IF97	Saturated steam
Saturated steam T	$\rho$ Calculate through temperature as per IAPWS-IF97	Saturated steam
General gas	$\rho$ Calculate as per ideal equation, a standard density is required.	Oxygen, nitrogen, hydrogen, etc
Without compensation	$\rho$ Calculate as per constant 1	Measure volume flow rate
Temperature linear compensation	$\rho = A + B * t$ , A, B are linear compensation coefficients	
Pressure linear compensation	$\rho = A + B * P$ , A, B are linear compensation coefficients	

Configuration Item Description:

configuration Item	Function Description	Parameter range
Channel	Select the accumulated channel	ACC1~ACC4
Status	Enable/Disenable this channel	Enable/Disenable
Unit	Unit displayed in accumulation interface	User-defined 8-bit character string
Signal source	Channel to be accumulated	AI1~AI18、 FLOW1~FLOW4 【Note 1】
Accumulation multiplying power	Multiply by multiplying power	0~99999
Accumulated initial value	Initial value at restoration	0~999999
Eliminate accumulated value	Reset this channel according to accumulated initial value	【Note 2】

【Note 1】 : When mode AO or remote Modbus input is selected, only AI1~AI12 is available.

【Note 2】 :After modifying the accumulated initial value, it requires to enable the configuration again to make it effective.

#### 4.5. Control setting

4 PID single loops are provided under PID control mode.

Configuration Item Description:

configuration Item	Function Description	Parameter range
Channel	Select PID channel to be set	PID1~PID4
Status	Enable/Disenable this channel	Enable/Disenable
Measurement value	Measurement value of PID calculation	AI1~AI12
Setting value	Setting value of PID calculation	None, AI1~AI12
P (%)	P in PDI calculation	0.0~9999.9
I (s)	I in PDI calculation	0.0~9999.9
D (s)	D in PDI calculation	0.0~9999.9
Control cycle	PDI calculation cycle	1s、2s、5s...60min
positive and negative effect	Positive and negative effect of PDI	Positive effect/ negative effect

configuration Item	Function Description	Parameter range
SVH (%)	Upper limit of setting value	0.00~100.00
SVL (%)	lower limit of setting value	0.00~100.00
MVH (%)	Output upper limit	0.0~100.0
MVL (%)	Output lower limit	0.0~100.0
DMV (%)	Max. value of output variation at a single cycle	0.0~100.0
A/M initial value	Auto/manual initial value	Manual/Auto
L/R initial value	Internal/external given initial value	Internal/external given value
SV (%) initial value	Setting value and initial value percent	0.00~100.00
MV (%) initial value	Percent of output initial value	0.0~100.0
A/M undisturbed switch	Undisturbed Manual/Auto switch	Enable/Disenable
Fault output	Output action in case of abnormal input signal	MVH、MVL、MV initial value

## 4.6. Function setting

### 4.6.1 Zero clearing

Configuration Item Description:

configuration Item	Function Description
Clear log record	Clear all log records
Clear accumulated report	Clear all accumulated reports
Clear power loss record	Clear all power loss records
Clear alarm information	Clear all alarm information

### 4.6.2 U disk operation

The instrument supports saving the current configuration to a USB disk or reading the configuration file therein.

Configuration Item Description:

configuration Item	Function Description	File format
Save recorder configuration	Save current recorder configuration	CFG (.cfg)
Read recorder configuration	Read recorder configuration in U disk NOTE: The recorder configuration is scanned when the U disk is inserted. The newly saved configuration can merely be displayed when U disk is inserted and plugged for once.	
Save log records	Save log records	

### 4.6.3 Communication setting

This product supports communication operation with a host computer (the matched host computer can be obtained in our WeChat official account/official website), thereby realizing real-time monitoring of the instrument. This product only supports Modbus protocol.

Configuration Item Description:

configuration Item	Function Description	Parameter range
Instrument address	Modbus Device Address	1~254
Baud Rate	Communication speed	1200,9600,57600,115200
Parity bit	Communication verify	No parity, odd parity, even parity
Floating-point format	Floating point format	1234,2143,3412,4321

#### 4.6.4 Remote setting

The remote input module can read the Modbus channel through the RS-485 terminal on the current board. It supports a maximum of 6 channels.

Configuration Item Description:

configuration Item	Function Description	Parameter range
Status	Functional switch for remote input	Enable/Disenable
Baud rate	Baud rate of serial port data	1200、9600、57600、115200
Check bit	Check bit of serial port data	No parity check, odd parity check, even-parity check
Channel 1		
Device address	Device address for the first remote channel	0-254, 0 indicates a close channel
Register address	Register address for the first remote channel	1~65535
Floating point format	Data format	F1234、F2143、F3412、F4321、L1234、L4321 【Note1】
Smoothing time	Average value smoothing	0s、1s、2s...30s
Correction factor A	A in $Y=A*X+B$	-99999~99999
Correction factor B	B in $Y=A*X+B$	-99999~99999
Channel 2		
Device address	Device address for the second remote channel	0-254, 0 indicates a close channel
Register address	Device address for the second remote channel	1~65535
Floating point format	Data format	F1234、F2143、F3412、F4321、L1234、L4321【Note 1】
Smoothing time	Average value smoothing	0s、1s、2s...30s
Correction factor A	A in $Y=A*X+B$	-99999~99999
Correction factor B	B in $Y=A*X+B$	-99999~99999
Channel 3		



configuration Item	Function Description	Parameter range
Device address	Device address for the third remote channel	0-254, 0 indicates a close channel
Register address	Device address for the third remote channel	1~65535
Floating point format	Data format	F1234、F2143、F3412、F4321、L1234、L4321【Note 1】
Smoothing time	Average value smoothing	0s、1s、2s...30s
Correction factor A	A in $Y=A*X+B$	-99999~99999
Correction factor B	B in $Y=A*X+B$	-99999~99999
Channel 4		
Device address	Device address for the fourth remote channel	0-254, 0 indicates a close channel
Register address	Device address for the fourth remote channel	1~65535
Floating point format	Data format	F1234、F2143、F3412、F4321、L1234、L4321【Note 1】
Smoothing time	Average value smoothing	0s、1s、2s...30s
Correction factor A	A in $Y=A*X+B$	-99999~99999
Correction factor B	B in $Y=A*X+B$	-99999~99999
Channel 5		
Device address	Device address for the fifth remote channel	0-254, 0 indicates a close channel
Register address	Device address for the fifth remote channel	1~65535
Floating point format	Data format	F1234、F2143、F3412、F4321、L1234、L4321【Note 1】
Smoothing time	Average value smoothing	0s、1s、2s...30s
Correction factor A	A in $Y=A*X+B$	-99999~99999
Correction factor B	B in $Y=A*X+B$	-99999~99999
Channel 6		

configuration Item	Function Description	Parameter range
Device address	Device address for the sixth remote channel	0-254, 0 indicates a close channel
Register address	Device address for the sixth remote channel	1~65535
Floating point format	Data format	F1234、F2143、F3412、F4321、L1234、L4321【Note 1】
Smoothing time	Average value smoothing	0s、1s、2s...30s
Correction factor A	A in $Y=A*X+B$	-99999~99999
Correction factor B	B in $Y=A*X+B$	-99999~99999

【Note 1】:F1234、F2143、F3412、F4321 is a single precision floating-point number of 4 bytes.L1234、L4321 is the 4-byte integer

#### Use of remote channel

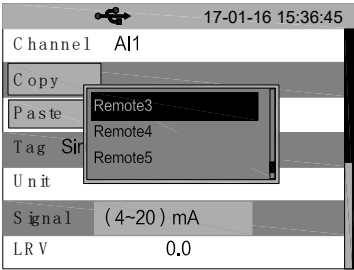
Step	Interface	Operation
1		<ul style="list-style-type: none"> <li>Select Remote1~Remote6 in the Signal configuration under Input Setting, which corresponds to remote channel 1-6, namely allowing display, alarm and record signal of same analog quantity.</li> </ul>

#### 4.6.5 User-defined screen

configuration Item	Function Description	Parameter range
Channel 1	Define the first channel	AI、FLOW
Channel 2	Define the second channel	AI、FLOW
Channel 3	Define the third channel	AI、FLOW
Channel 4	Define the fourth channel	AI、FLOW
Channel 5	Define the fifth channel	AI、FLOW
Channel 6	Define the sixth channel	AI、FLOW

#### 4.7. System Settings

Configuration Item Description:

configuration Item	Function Description	Parameter range
Password	Set password	000000~999999
recorder name	Set recorder name	8-bit character string
System time	Set recorder time	
Time format	Set time display format.	YY-MM-DD、DD-MM-YY、 MM-DD-YY
record interval	Set record interval	1s、2s、5s...60min(One second can be recorded for 10 days)
Curve coordinate	Set curve coordinate	Percent and engineering quantity
Language	Select system language	Chinese/English
Starting up interface	Set the default starting up interface	General interface, digital display interface, historical interface, flow interface, cumulative flow, real-time curve.
Cycling time	Display cycling time by group	0s、5s、10s、30s
Atmospheric pressure MPa	Set the atmospheric	-100000000~100000000
Reset default configuration	pressure of the recorder	

**Appendix 1: Address and Examples of Modbus**

Number	Parameter	Types of parameter	Starting address of register (decimal)	The number of register
1	No.1 channel analog input	Floating point type	1	2 registers
2	No.2 channel analog input	Floating point type	3	2 registers
3	No.3 channel analog input	Floating point type	5	2 registers
4	No.4 channel analog input	Floating point type	7	2 registers
5	No.5 channel analog input	Floating point type	9	2 registers
6	No.6 channel analog input	Floating point type	11	2 registers
7	No.7 channel analog input	Floating point type	13	2 registers
8	No.8 channel analog input	Floating point type	15	2 registers
9	No.9 channel analog input	Floating point type	17	2 registers
10	No.10 channel analog input	Floating point type	19	2 registers
11	No.11 channel analog input	Floating point type	21	2 registers
12	No.12 channel analog input	Floating point type	23	2 registers
13	No.13 channel analog input	Floating point type	25	2 registers
14	No.14 channel analog input	Floating point type	27	2 registers
15	No.15 channel analog input	Floating point type	29	2 registers
16	No.16 channel analog input	Floating point type	31	2 registers
17	No.17 channel analog input	Floating point type	33	2 registers

18	No.18 channel analog input	Floating point type	35	2 registers
----	----------------------------	---------------------	----	-------------

**Address table of Modbus:**

No.	Parameter	Parameter type	Initial address of register (Decimalist)	Register number
1	Flow of the first channel	Parameter type	2001	2 registers
2	Flow of the second channel	Parameter type	2003	2 registers
3	Flow of the third channel	Parameter type	2005	2 registers
4	Flow of the fourth channel	Parameter type	2007	2 registers
No.	Parameter	Parameter type	Initial address of register (Decimalist)	Register number
1	Accumulated Flow of the first channel	Integer	4001	2 registers
2	Accumulated Flow of the second channel	Integer	4003	2 registers
3	Accumulated Flow of the third channel	Integer	4005	2 registers
4	Accumulated Flow of the fourth channel	Integer	4007	2 registers

No.	Parameter	Parameter type	Initial address of register (Decimalist)	Register number
1	Accumulated Flow of the first channel	Parameter type	5001	2 registers
2	Accumulated Flow of the second channel	Parameter type	5003	2 registers
3	Accumulated Flow of the third channel	Parameter type	5005	2 registers
4	Accumulated Flow of the fourth channel	Parameter type	5007	2 registers

**Communication Example:**

Example 1: Real-time value of analog input 2

State :

Explanations : 06 03 00 03 00 02 35 BC

06: instruments address (Configuration can be changed)

03: 03 order to Modbus

00 03: Address 3 of register

00 02: The number of registers is 2

35 BC: CRC Verify

Returned data: 01 03 04 42 C8 00 00 6F B5

Explanations:

01: Instruments address

03: 03 order to Modbus

04: Four bytes of returned date

42 C8 00 00: Floating point(F4321 , configuration can be modified) , It represents 100.0

6F B5: CRC Verify

## Appendix 2: Calculation of flow coefficient K

Case 1: Orifice (no extraction of a root for differential pressure), measure the flow of oxygen in Nm<sup>3</sup>/h.

### Calculation sheet

<u>process data:</u>	design	max	norm	min	Einheit
absolute pressure	950.000				kPa
temperature	20.0				°C
Flow	40000.00 000	36000.000 00	21500.000 00	10800.00 000	Nm <sup>3</sup> /h
expansion coefficient	0.9994	1.0000	0.9998	0.9995	-
reynolds	278E+04	25,009E+0 2	14,936E+0 2	75,026E+ 01	-
fluid velocity	12.3963	11.1567	6.6630	3.3470	m/s
pressure loss	0.1066	0.0863	0.0308	0.0078	kPa
differential pressure	1.8400	1.4901	0.5312	0.1340	kPa

### Obtain the following information based on the calculation sheet:

parameter	Value
Design pressure	0.95MPa
Design temperature	20°C
Design flow	40000Nm <sup>3</sup> /h
Design differential pressure	1.84kPa

**Calculation method:**

The oxygen density under standard conditions and design temperature pressure are calculated.

According to the ideal state equation:

$$PV = (mRT / M) = nRT$$

$$PV = mRT / M$$

$$PM / RT = m / V = \rho$$

$$\rho = PM / RT$$

The density under standard conditions is 1.429Kg/m<sup>3</sup>.

The density under design temperature pressure is 12.485Kg/m<sup>3</sup>.

Calculate according to the formula  $Q = K * \sqrt{\Delta P * \rho}$ , which is substituted by design parameters.

$$40000 * 1.429 = K * \sqrt{1.84 * 12.485}$$

$$K=11926.1$$

**Note:**

Since the designed flow unit is Nm<sup>3</sup>/h, first, convert the designed flow unit into standard unit. The flow unit obtained at this time is Kg/h. If you want to acquire t/h, you need to reduce K by 1000 times to 11.9261. If you want to acquire Nm<sup>3</sup>/h, you need to use K to divide by the density under standard conditions 1.429 to obtain 8345.7.