

QT50L/ QT50ML
QT70L/ QT70ML

New Model Concept which Allows for Significant Customization to Your Specific Needs Using Special Modular Components



- QT Series tower light is a multifunctional product that allows for significant customization to your specific needs using our special modular components such as the lens, buzzer, ethernet cord, USB cord and mounting brackets. Additional tools are not required for assembly
- All modular components can be arranged freely to the user desired position (upper/ lower) except for the dial tone lever



• Buzzer modules position can be chosen freely

The buzzer module is designed to be compatible with the light modules by using a novel architecture developed by Qlight. Therefore, users can reposition the module to the location they desire. In the photo to the left, the buzzer module is located at the top, center and bottom positions.

• Can select from a variety of LED light functions

The LED indicator can provide varying signals/actions by using different independent light modules; flashing, strobe, rotating. For example, green would indicate normal operation, a red module would indicate risk which can be highlighted further by selecting a strobe flashing or rotating module.



1 Buzzer Tone Type
1 Buzzer Tone Type



5 Warning Sounds Type
5 Melodies Type
5 Alarms Type

• Select from 15 kinds of buzzer tones

There are 4 audible modules available which includes one buzzer type module and 3 alarm modules. Each alarm module comes with 5 sound patterns that can be selected for your specific application environment. The Buzzer module is customizable with two options- the 1 tone buzzer and high volume buzzer. Detailed specifications of the alarm sounds and buzzer sounds are included in page 91-93.

• Can select from a variety of pole selections to fit your application needs

You can chose from 8 different kinds of pole options for mounting. The pole materials vary from steel, aluminum, and polycarbonate. Please refer to page 190-195 for more detailed information about the pole specifications and dimensions.



• Module Selections

Users can directly purchase the necessary modules for assembly. Detailed specifications and features for each Individual module are introduced in page 95-98(QT50), page 105-108(QT70). For information about module combination procedure can be found in the assembly Instructions page.

• Assembled Product

We are able to provide the consumer with an assembled product with module specifications provided by the customer. Specifications and products assembled in a variety of formats are detailed in page 99-104(QT50), page 109-114(QT70).

QT series

Modular Multi-Functional LED Tower Lights

Module

Multi-functional module can be assemble to user requirements

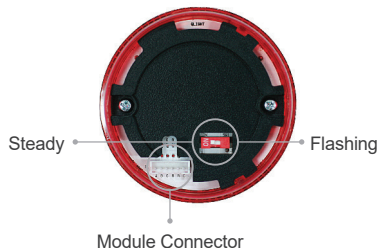

Please use the switch for Steady and Flashing which is on top of Q50L-F and Q70L-F, LED steady/flashing module.

LED Module

- 4 kinds of LED modules; Steady, steady/flashing, strobe, revolving flashing
- Good visibility with high brightness.
- Module position can be chosen based on signal importance.



LED Steady Module

- Output LED Steady signal
- High brightness LED
- Voltage : DC12V, DC24V, AC110V, AC220V



LED Steady/Flashing Module

- Output LED Steady/Flashing signal
- High brightness LED
- Voltage : DC12V, DC24V, AC110V, AC220V



LED Strobe Module

- LED flashing light
- Excellent notice compare to flashing type
- Voltage : DC12V, DC24V



LED Revolving Flashing Module

- LED light revolve and flash
- Dynamic Signal
- Voltage : DC12V, DC24V

Buzzer Module

- Buzzer module has Siren and Bip sound, Bip sound is adjustable.
- Buzzer module position can be chosen freely and has a good air tight seal.



Siren Sound Buzzer Module

- Siren buzzer volume : Max 90dB
- Sound fixed
- Voltage : DC12V, DC24V, AC110V, AC220V



Bip Sound Buzzer Module

- Bip sound(Pi-Pi) volume : Max 90dB
- Sound adjustable
- Voltage : DC12V, DC24V, AC110V, AC220V



- Sound adjustable by lever on module side
- Buzzer module position can be chosen freely

QT series

Modular Multi-Functional LED Tower Lights

Basic Signal Sound Module

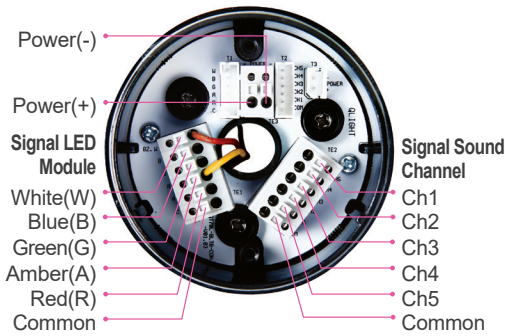

Please follow wiring instruction for power and signal line on page 114.



Lever for sound adjustment
Channel switch

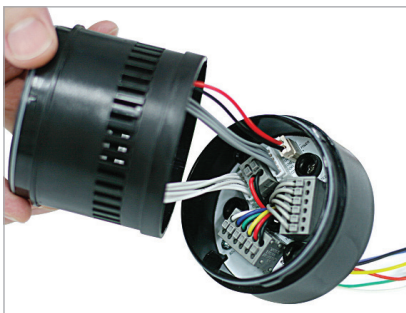

Example for Signal Sound Module

Signal Sound Module

- Warning sound, melody, and alarm sound selection can be chosen by dip switch or external contact on top of module.
- For sound selection by dip switch the module can be in any position. However, for sound selection by external contact the module should be located at the base/ bottom.
- Excellent air tight seal.

	<p>Warning Sound Module</p> <ul style="list-style-type: none"> • 5 Warning sounds : Max 85dB - fire, emergency , Ambulance, PI.PI.PI Short, Machinery Fault , Beep Intermittent • Voltage : USB DC5V
	<p>Melody Module</p> <ul style="list-style-type: none"> • 5 Melodies : Max 85dB - Sweet home, For Elise, Cuckoo's Waltz, Piano sonata, Turkish March • Voltage : USB DC5V
	<p>Alarm Module</p> <ul style="list-style-type: none"> • 5 Alarms : Max 85dB - Beep Intermittent, Door Chime, Phone Ring, PI.PI.PI Short, Triple Beat • Voltage : USB DC5V

Signal Sound Selection and Sound Adjust

- Signal module built-in 3 signal sounds, warning sound(WA), melody(WM) and alarm(WA) (User can select sound patten when ordering).
- Warning sound, melody, and alarm and sound selection can be chosen by dip switch or external contact on top of module.
- Sound can be adjusted by lever on module.
- Please refer to below list for sound and specification.

Article	Built-in sounds	Channel	Sound
WS	5 Warning Sounds	Ch1 Ch2 Ch3 Ch4 Ch5	Fire, emergency Ambulance PI.PI.PI Short Machinery Fault Beep Intermittent
WM	5 Melodies	Ch1 Ch2 Ch3 Ch4 Ch5	Sweet home For Elise Cuckoo's Waltz Piano sonata Turkish March
WA	5 Alarms	Ch1 Ch2 Ch3 Ch4 Ch5	Beep Intermittent Door Chime Phone Ring PI.PI.PI Short Triple Beat

- For sound selection by external contact, please refer to the following picture for an example of easy wiring of the sound module using the enclosed signal lines for the module.

USB Module(Built-in Signal Sound)

- LED tower light system with built-in sound connected and controlled by a PC application program.
- Sound module should be positioned at the base of the tower light.
- Sound can be adjusted with the lever on the module.

<p>Q70L-USB-WS Q50L-USB-WS</p>	<p>Built-in Warning USB Sound Module</p> <ul style="list-style-type: none"> • 5 Warning sounds : Max 85dB - fire, emergency , Ambulance, PI.PI.PI Short, Machinery Fault , Beep Intermittent • Voltage : DC12V, DC24V
<p>Q70L-USB-WM Q50L-USB-WM</p>	<p>Built-in Melody USB Module</p> <ul style="list-style-type: none"> • 5 Melodies : Max 85dB - Sweet home, For Elise, Cuckoo's Waltz, Piano sonata, Turkish March • Voltage : DC12V, DC24V
<p>Q70L-USB-WA Q50L-USB-WA</p>	<p>Built-in Alarm USB Module</p> <ul style="list-style-type: none"> • 5 Alarms : Max 85dB - Beep Intermittent, Door Chime, Phone Ring, PI.PI.PI Short, Triple Beat • Voltage : DC12V, DC24V

Module Connection



1 Connect wire between module



2 Match the edge of module



3 To assemble turn right

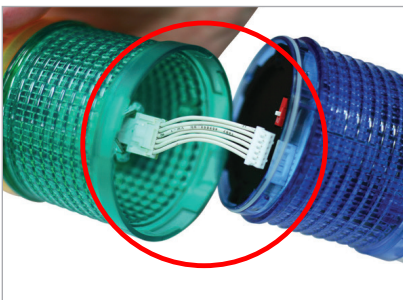

Uses a connector for easy assembly.

Ethernet Module(Built-in Signal Sound)

- Ethernet tower light system that can be controlled by internet or LAN from a remote place.
- Sound module should be positioned at the base of the tower light.
- Sound can be adjust with the lever on the module.
- Excellent air tight seal.

<p>Q70L-ETN-WS Q50L-ETN-WS</p>	<p>Built-in Warning Ethernet Sound Module</p> <ul style="list-style-type: none"> • 5 Warning sounds : Max 85dB - fire, emergency , Ambulance, PI.PI.PI Short, Machinery Fault , Beep Intermittent • Voltage : DC12V, DC24V
<p>Q70L-ETN-WM Q50L-ETN-WM</p>	<p>Built-in Melody Ethernet Module</p> <ul style="list-style-type: none"> • 5 Melodies : Max 85dB - Sweet home, For Elise, Cuckoo's Waltz, Piano sonata, Turkish March • Voltage : DC12V, DC24V
<p>Q70L-ETN-WA Q50L-ETN-WA</p>	<p>Built-in Alarm Ethernet Module</p> <ul style="list-style-type: none"> • 5 Alarms : Max 85dB - Beep Intermittent, Door Chime, Phone Ring, PI.PI.PI Short, Triple Beat • Voltage : DC12V, DC24V

Module Connection

- Adopts a convenient connector for easy assemble.
- Simple connection structure makes assembly straightforward and effortless when compared to other manufacturer's products.

QT series

Modular Multi-Functional LED Tower Lights



Base Module is composed of the control line and threaded to the mounting bracket for improved product mounting efficiency. Please refer to below instruction and choose the mount type.

Base Module

- 6P terminal plate equipped on basic module. Please refer to page 115 for wiring of power line and signal line.

Direct Mount		3 Bolts on base module
Wall Mount		Wall mount bracket on base module
Pole Mount		Pole module and pole assemble on base module

Module Color

- Housing color of the QT series modular tower lights is black
- Customizable in beige color



Wiring Instructions

- QT series can be wired to external contact and transistor
 - In case of wiring with transistor, please select the proper transistor type either NPN or PNP based on the source voltage setting
 - DC Steady type : External power/External signal line : UL1007 AWG22(0.3sq) 400mm
 - AC Steady, AC/DC steady/flashing type :
External power line : UL1015 AWG18(0.75sq)×2C 400mm
 - External signal line : UL1007 AWG22(0.3sq)400mm
- ※ Please refer to page 115 for detailed wiring instructions.

Power Line Wiring Instructions

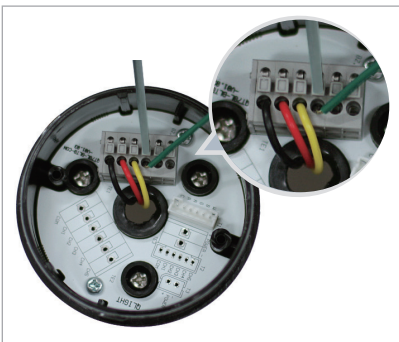

Terminal box can be wired without a special tool by using the push and release locking mechanism.



Mounting Bracket

- Pole Mounting Bracket

Standard	LB18 LB24	LW18 LW24	QZ18 QZ24	SZ18 SZ24	QL18 QL24	SL18 SL24	QLA18 QLA24
Steel	Steel	PC	PC	Al	PC	Al	PC

※ Please refer to page 190-195 for detailed information about the pole specifications and dimensions.

QT70 series

Modular Multi-Functional LED Tower Lights



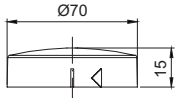

Module Specifications QT70L/QT70ML

(Units : mm)

Shape	Parts Name	Model No.	Common Specifications	
	QT70L cover	Q70L-CV	<ul style="list-style-type: none"> Material : PC Protection ratings with assemble : IP 65 Product size : $\varnothing 70 \times 15$ 	

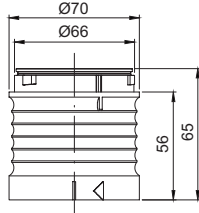

LED Steady Module

(Units : mm)

Shape	Parts Name	Model No.	Specification		Common Specifications
			Voltage	Current	
	Q70L-NR Red LED Steady Module	Q70L-NR-12 Q70L-NR-24 Q70L-NR-110 Q70L-NR-220	DC12V DC24V AC110V AC220V	0.100A 0.050A 0.020A 0.020A	<ul style="list-style-type: none"> Material : PC Protection ratings with assemble : IP 65 Product size : $\varnothing 70 \times 65$ 
	Q70L-NA Amber LED Steady Module	Q70L-NA-12 Q70L-NA-24 Q70L-NA-110 Q70L-NA-220	DC12V DC24V AC110V AC220V	0.100A 0.050A 0.020A 0.020A	
	Q70L-NG Green LED Steady Module	Q70L-NG-12 Q70L-NG-24 Q70L-NG-110 Q70L-NG-220	DC12V DC24V AC110V AC220V	0.100A 0.050A 0.020A 0.020A	
	Q70L-NB Blue LED Steady Module	Q70L-NB-12 Q70L-NB-24 Q70L-NB-110 Q70L-NB-220	DC12V DC24V AC110V AC220V	0.100A 0.050A 0.020A 0.020A	
	Q70L-NC White LED Steady Module	Q70L-NC-12 Q70L-NC-24 Q70L-NC-110 Q70L-NC-220	DC12V DC24V AC110V AC220V	0.100A 0.050A 0.020A 0.020A	

LED Flashing Module

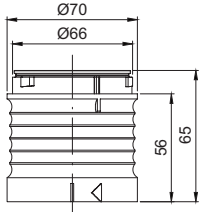
(Units : mm)



Shape	Parts Name	Model No.	Specification		Common Specifications
			Voltage	Current	
	Q70L-FR Red LED Flashing Module	Q70L-FR-12 Q70L-FR-24 Q70L-FR-110 Q70L-FR-220	DC12V DC24V AC110V AC220V	0.100A 0.050A 0.020A 0.020A	<ul style="list-style-type: none"> Material : PC Protection ratings with assemble : IP 65 Product size : $\varnothing 70 \times 65$ 
	Q70L-FA Amber LED Flashing Module	Q70L-FA-12 Q70L-FA-24 Q70L-FA-110 Q70L-FA-220	DC12V DC24V AC110V AC220V	0.100A 0.050A 0.020A 0.020A	
	Q70L-FG Green LED Flashing Module	Q70L-FG-12 Q70L-FG-24 Q70L-FG-110 Q70L-FG-220	DC12V DC24V AC110V AC220V	0.100A 0.050A 0.020A 0.020A	

QT70 series





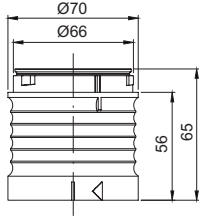

Modular Multi-Functional LED Tower Lights

(Units : mm)

Shape	Parts Name	Model No.	Specification		Common Specifications
			Voltage	Current	
	Q70L-FB Blue LED Flashing Module	Q70L-FB-12 Q70L-FB-24 Q70L-FB-110 Q70L-FB-220	DC12V DC24V AC110V AC220V	0.100A 0.050A 0.020A 0.020A	<ul style="list-style-type: none"> Material : PC Protection rating : IP65 Dimension : Ø70×65 
	Q70L-FC White LED Flashing Module	Q70L-FC-12 Q70L-FC-24 Q70L-FC-110 Q70L-FC-220	DC12V DC24V AC110V AC220V	0.100A 0.050A 0.020A 0.020A	

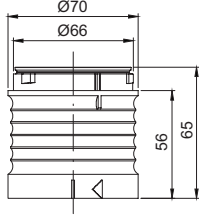

LED Strobe Module

(Units : mm)

Shape	Parts Name	Model No.	Specification		Common Specifications
			Voltage	Current	
	Q70L-SR Red LED Strobe Module	Q70L-SR-12 Q70L-SR-24	DC12V DC24V	0.120A 0.120A	<ul style="list-style-type: none"> Material : PC Protection rating : IP65 Dimension : Ø70×65 
	Q70L-SA Amber LED Strobe Module	Q70L-SA-12 Q70L-SA-24	DC12V DC24V	0.120A 0.120A	
	Q70L-SG Green LED Strobe Module	Q70L-SG-12 Q70L-SG-24	DC12V DC24V	0.120A 0.120A	
	Q70L-SB Blue LED Strobe Module	Q70L-SB-12 Q70L-SB-24	DC12V DC24V	0.120A 0.120A	
	Q70L-SC White LED Strobe Module	Q70L-SC-12 Q70L-SC-24	DC12V DC24V	0.120A 0.120A	

LED Revolving Flashing module

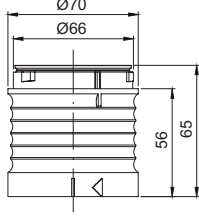

(Units : mm)

Shape	Parts Name	Model No.	Specification		Common Specifications
			Voltage	Current	
	Q70L-RR Red LED Revolving Flashing Module	Q70L-RR-12 Q70L-RR-24	DC12V DC24V	0.080A 0.080A	<ul style="list-style-type: none"> Material : PC Protection rating : IP65 Dimension : Ø70x65 
	Q70L-RA Amber LED Revolving Flashing Module	Q70L-RA-12 Q70L-RA-24	DC12V DC24V	0.080A 0.080A	

QT70 series

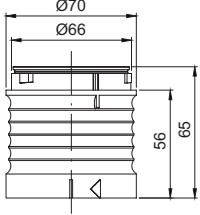

Modular Multi-Functional LED Tower Lights

(Units : mm)

Shape	Parts Name	Model No.	Specification		Common Specifications
			Voltage	Current	
	Q70L-RG Green LED Revolving Flashing Module	Q70L-RG-12 Q70L-RG-24	DC12V DC24V	0.080A 0.080A	<ul style="list-style-type: none"> Material : PC Protection rating : IP65 Dimension : Ø70×65 
	Q70L-RB Blue LED Revolving Flashing Module	Q70L-RB-12 Q70L-RB-24	DC12V DC24V	0.080A 0.080A	
	Q70L-RC White LED Revolving Flashing Module	Q70L-RC-12 Q70L-RC-24	DC12V DC24V	0.080A 0.080A	

Buzzer Module

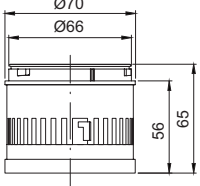
(Units : mm)

Shape	Parts Name	Model No.	Specification		Common Specifications
			Voltage	Current	
	Q70L-BZ Buzzer Module	Q70L-BZ-12 Q70L-BZ-24 Q70L-BZ-110 Q70L-BZ-220	DC12V DC24V AC110V AC220V	0.015A 0.030A 0.090A 0.090A	<ul style="list-style-type: none"> Material : PC Protection rating : IP54 Dimension : Ø70×65 Volume : Max 90dB 
	Q70L-BZS Siren Buzzer Module	Q70L-BZS-12 Q70L-BZS-24 Q70L-BZS-110 Q70L-BZS-220	DC12V DC24V AC110V AC220V	0.240A 0.150A 0.010A 0.020A	

Signal Sound Module

(Units : mm)

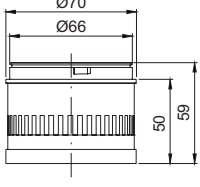
Shape	Parts Name	Model No.	Specification		Common Specifications
			Voltage	Current	
	Q70L-WS Warning Sound Module	Q70L-WS-12 Q70L-WS-24	DC12V DC24V	0.220A 0.130A	<ul style="list-style-type: none"> Material : PC Protection rating : IP54 Dimension : Ø70×59 Volume : Max 85dB 
	Q70L-WM Melody Module	Q70L-WM-12 Q70L-WM-24	DC12V DC24V	0.220A 0.130A	
	Q70L-WA Alarm Module	Q70L-WA-12 Q70L-WA-24	DC12V DC24V	0.220A 0.130A	

QT70 series

Modular Multi-Functional LED Tower Lights

USB Module(Built-in Signal Sound)

(Units : mm)

Shape	Parts Name	Model No.	Specification		Common Specifications
			Voltage	Current	
	Q70L-USB-WS Warning Sound Module (USB Type)	Q70L-USB-WS-12 Q70L-USB-WS-24	USB DC5V	0.500A	<ul style="list-style-type: none"> Material : PC Protection rating : IP54 Dimension : Ø70×59 Volume : Max 85dB
	Q70L-USB-WM Melody Module (USB Type)	Q70L-USB-WM-12 Q70L-USB-WM-24	USB DC5V	0.500A	
	Q70L-USB-WA Alarm Module (USB Type)	Q70L-USB-WA-12 Q70L-USB-WA-24	USB DC5V	0.500A	

Ethernet Module(Built-in Signal Sound)

(Units : mm)

Shape	Parts Name	Model No.	Specification		Common Specifications
			Voltage	Current	
	Q70L-ETN-WS Warning Sound Module (Ethernet Type)	Q70L-ETN-WS-12 Q70L-ETN-WS-24	DC12V DC24V	0.220A 0.120A	<ul style="list-style-type: none"> Material : PC Protection rating : IP54 Dimension : Ø70×59 Volume : Max 85dB
	Q70L-ETN-WM Melody Module (Ethernet Type)	Q70L-ETN-WM-12 Q70L-ETN-WM-24	DC12V DC24V	0.220A 0.120A	
	Q70L-ETN-WA Alarm Module (Ethernet Type)	Q70L-ETN-WA-12 Q70L-ETN-WA-24	DC12V DC24V	0.220A 0.120A	

Base Module

(Units : mm)

Shape	Parts Name	Model No.	Common Specifications
	Pole Mount Base Module Direct Mount Base Module	Q70L-BS	<ul style="list-style-type: none"> Material : PC Protection rating : IP65 Dimension : Ø70×36
	Built-in Signal Sound Base Module	Q70L-W-BS	
	PC Control Base Module	Q70L-Special-BS	

Mount Bracket Module(Built-in Sounder)

(Units : mm)

Shape	Parts Name	Model No.	Material	Technical Diagram
	Wall Mount Bracket	TWS80	Steel	
	Wall Mount Bracket	TWA80	PC	
	Pole Module	Q70L-PB	PC	

QT70L

Ø70mm Multi-Functional Modular LED Tower Lights

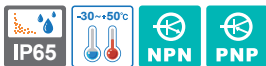

QT70L

Color Options:

Beige color is available



QT70L Ø70mm Pole Mount Modular LED Tower Lights

Product consist of cover, LED modules, base module, and pole module

Specifications

Model number	Layer	Voltage	Current	Certificates	Weight	Color
QT70L QT70LF	1	DC12V	0.100A	CE DC only	0.41kg	● R-Red
		DC24V	0.050A		0.41kg	
		AC110V	0.020A		0.42kg	
		AC220V	0.020A		0.42kg	
	2	DC12V	0.200A		● R-Red ● G-Green	0.48kg
		DC24V	0.100A			0.48kg
		AC110V	0.040A			0.49kg
		AC220V	0.040A			0.49kg
	3	DC12V	0.300A		● R-Red ● A-Amber ● G-Green	0.55kg
		DC24V	0.150A			0.55kg
		AC110V	0.060A			0.56kg
		AC220V	0.060A			0.56kg
	4	DC12V	0.400A		● R-Red ● A-Amber ● G-Green ● B-Blue	0.63kg
		DC24V	0.200A			0.63kg
		AC110V	0.080A			0.64kg
		AC220V	0.080A			0.64kg
	5	DC12V	0.500A		● R-Red ● A-Amber ● G-Green ● B-Blue ● W-White	0.71kg
		DC24V	0.250A			0.71kg
		AC110V	0.100A			0.72kg
		AC220V	0.100A			0.72kg

QT70L Steady Module + Base Module(BS)
 QT70LF Flashing Module + Pole Module(PB)

※ Please refer to page 105-108 for detailed specification of module.

Technical Diagram (Units : mm)

QT70L

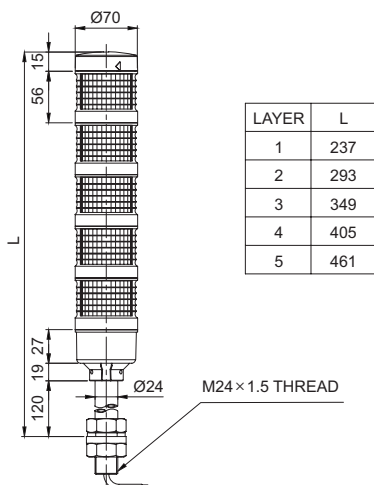

Customization

- Customized pole length available
- Beige color
- LED strobe (Model number : QT70LS)
- LED simulated revolving (Model number : QT70LR)

Wiring Instructions

• LED tower light can be wired with external contact and transistor

※ Please refer to page 115 for detailed information about the wiring instructions.

Mounting Bracket

Standard	LB24	LW24	QZ24	SZ24	QL24	SL24	QLA24
Steel	Steel	PC	PC	Al	PC	Al	PC

※ Please refer to page 190-195 for detailed dimension of mount brackets.

Ordering Specification

QT70L	-	3	-	24	-	RAG	-	QZ24
[Model number]		[Layer]		[Voltage]		[Color]		[Mounting bracket]
• QT70L • QT70LF		• 1-1Layer • 2-2Layers • 3-3Layers • 4-4Layers • 5-5Layers		• 12-DC12V • 24-DC24V • 110-AC110V • 220-AC220V		• R-Red • A-Amber • G-Green • B-Blue • W-White		• None • -Standard • Bracket • -LB24 -LW24 • -QZ24 -SZ24 • -QL24 -SL24 • -QLA24

QT70L-BZ

Ø70mm Multi-Functional Modular LED Tower Lights with Buzzer

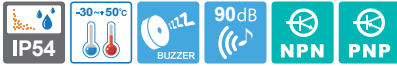

QT70L-BZ

Color Options:

Beige color is available



Technical Diagram (Units : mm)

QT70L-BZ

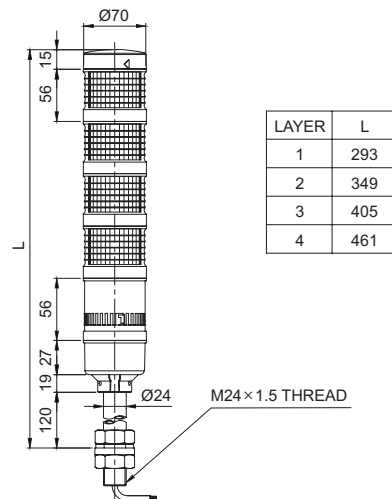

Customization

- Customized pole length available
- Beige color
- LED strobe (Model number : QT70LS-BZ)
- LED simulated revolving (Model number : QT70LR-BZ)



QT70L-BZ Ø70mm Pole Mount Modular LED Tower Lights with Buzzer

Product consist of cover, LED modules, buzzer module, base module, and pole module



Specifications

Model number	Layer	Voltage	Current	Certificates	Weight	Color
QT70L-BZ QT70LF-BZ (Max 90dB)	1	DC12V	0.115A	CE DC24V only	0.50kg	• R-Red
		DC24V	0.080A		0.50kg	
		AC110V	0.110A		0.51kg	
		AC220V	0.110A		0.51kg	
	2	DC12V	0.215A		0.58kg	• R-Red • G-Green
		DC24V	0.130A		0.88kg	
		AC110V	0.130A		0.59kg	
		AC220V	0.130A		0.59kg	
	3	DC12V	0.315A		0.65kg	• R-Red • A-Amber • G-Green
		DC24V	0.180A		0.65kg	
		AC110V	0.150A		0.66kg	
		AC220V	0.150A		0.66kg	
	4	DC12V	0.415A		0.73kg	• R-Red • A-Amber • G-Green • B-Blue
		DC24V	0.230A		0.73kg	
		AC110V	0.170A		0.74kg	
		AC220V	0.170A		0.74kg	

QT70L Steady Module + Base Module(BS) + Buzzer Module(BZ)
 QT70LF Flashing Module + Pole Module(PB)

※ Please refer to page 105-108 for detailed specification of module.



Wiring Instructions

- LED tower light can be wired with external contact and transistor
- ※ Please refer to page 115 for detailed information about the wiring instructions.



Mounting Bracket

Standard	LB24	LW24	QZ24	SZ24	QL24	SL24	QLA24
Steel	Steel	PC	PC	Al	PC	Al	PC

※ Please refer to page 190-195 for detailed dimension of mount brackets.



Ordering Specification

QT70L-BZ	-	3	-	24	-	RAG	-	QZ24
[Model number]		[Layer]		[Voltage]		[Color]		[Mounting bracket]
• QT70L-BZ • QT70LF-BZ		• 1-1Layer • 2-2Layers • 3-3Layers • 4-4Layers		• 12-DC12V • 24-DC24V • 110-AC110V • 220-AC220V		• R-Red • A-Amber • G-Green • B-Blue		• None • -Standard • Bracket • -LB24 • -LW24 • -QZ24 • -SZ24 • -QL24 • -SL24 • -QLA24

QT70L-W

Ø70mm Multi-Functional Modular LED Tower Lights with Signal Sound



QT70L-W

Color Options:

Beige color is available



Technical Diagram (Units : mm)

QT70L-W

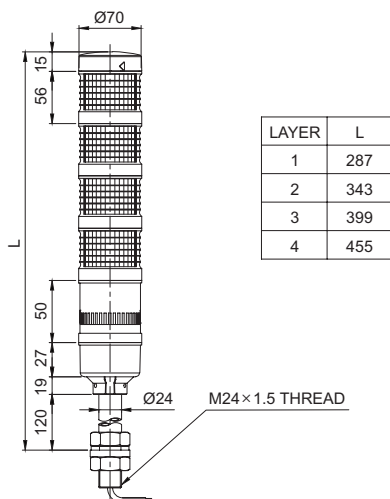

Customization

- Customized pole length available
- Beige color
- LED strobe (Model number : QT70LS-W)
- LED simulated revolving (Model number : QT70LR-W)



QT70L-W Ø70mm Pole Mount Modular LED Tower Lights with Signal Sound

Product consist of cover, LED modules, signal sound module, base module, and pole module



Specifications

Model number	Layer	Built-in Sound	Voltage	Current	Certificates	Weight	Color
QT70L-WS QT70L-WM QT70L-WA QT70LF-WS QT70LF-WM QT70LF-WA	1	WS-5 Warning sounds WM-5 Melodies WA-Alarms (Max 85dB)	DC12V	0.320A	CE DC24V only	0.62kg	• R-Red
			DC24V	0.180A		0.62kg	
	2		DC12V	0.420A		0.69kg	• R-Red • G-Green
			DC24V	0.230A		0.69kg	
	3		DC12V	0.520A		0.76kg	• R-Red • A-Amber • G-Green
			DC24V	0.280A		0.76kg	
	4		DC12V	0.620A		0.84kg	• R-Red • A-Amber • G-Green • B-Blue
			DC24V	0.330A		0.84kg	

QT70L Steady Module + Base Module(BS) + Signal Sound Module
 QT70LF Flashing Module + Pole Module(PB) + WS Warning sounds
 WM Melodies
 WA Alarms

※ Please refer to page 104-107 for detailed specification of module.

※ Please refer to page 186 for detailed sound specification.



Wiring Instructions

• LED tower light can be wired with external contact and transistor

※ Please refer to page 115 for detailed information about the wiring instructions.



Mounting Bracket

Standard	LB24	LW24	QZ24	SZ24	QL24	SL24	QLA24
Steel	Steel	PC	PC	Al	PC	Al	PC

※ Please refer to page 190-195 for detailed dimension of mount brackets.



Ordering Specification

QT70L-WA	-	3	-	24	-	RAG	-	QZ24
[Model number]		[Layer]		[Voltage]		[Color]		[Mounting bracket]
<ul style="list-style-type: none"> • QT70L-WS • QT70L-WM • QT70L-WA • QT70LF-WS • QT70LF-WM • QT70LF-WA 		<ul style="list-style-type: none"> • 1-1Layer • 2-2Layers • 3-3Layers • 4-4Layers 		<ul style="list-style-type: none"> • 12-DC12V • 24-DC24V 		<ul style="list-style-type: none"> • R-Red • A-Amber • G-Green • B-Blue 		<ul style="list-style-type: none"> • None -Standard • Bracket -LB24 -LW24 -QZ24 -SZ24 -QL24 -SL24 -QLA24

QT70ML

Ø70mm Multi-Functional Modular LED Tower Lights

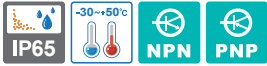

QT70ML

Color Options:

Beige color is available



QT70ML Ø70mm Direct Mount Modular LED Tower Lights

Product consist of cover, LED modules, signal sound module, base module



Specifications

Model number	Layer	Voltage	Current	Certificates	Weight	Color
QT70ML QT70MLF	1	DC12V DC24V AC110V AC220V	0.100A 0.050A 0.020A 0.020A	CE DC24V only	0.17kg 0.17kg 0.18kg 0.18kg	● R-Red
	2	DC12V DC24V AC110V AC220V	0.200A 0.100A 0.040A 0.040A		0.25kg 0.25kg 0.26kg 0.26kg	● R-Red ● G-Green
	3	DC12V DC24V AC110V AC220V	0.300A 0.150A 0.060A 0.060A		0.32kg 0.32kg 0.33kg 0.33kg	● R-Red ● A-Amber ● G-Green
	4	DC12V DC24V AC110V AC220V	0.400A 0.200A 0.080A 0.080A		0.40kg 0.40kg 0.41kg 0.41kg	● R-Red ● A-Amber ● G-Green ● B-Blue
	5	DC12V DC24V AC110V AC220V	0.500A 0.250A 0.100A 0.100A		0.47kg 0.47kg 0.48kg 0.48kg	● R-Red ● A-Amber ● G-Green ● B-Blue ● W-White

QT70L Steady Module + Base Module(MBS)
QT70LF Flashing Module

※ Please refer to page 104-107 for detailed specification of module.



Technical Diagram (Units : mm)

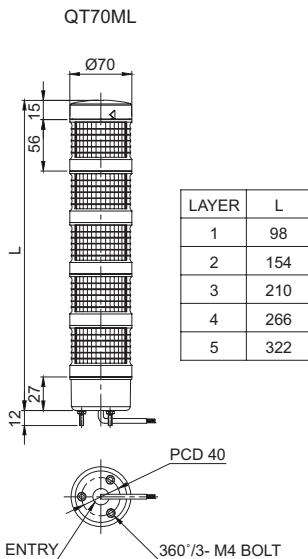

Wiring Instructions

- LED tower light can be wired with external contact and transistor
- ※ Please refer to page 115 for detailed information about the wiring instructions.



Customization

- Beige color
- LED strobe (Model number : QT70MLS)
- LED simulated revolving (Model number : QT70MLR)
- Wall mount bracket :
Bracket structure allows for threading through the bracket hole or into the wall mount



Ordering Specification

QT70ML	-	3	-	220	-	RAG
[Model number]		[Layer]		[Voltage]		[Color]
<ul style="list-style-type: none"> • QT70ML • QT70MLF 		<ul style="list-style-type: none"> • 1-1Layer • 2-2Layers • 3-3Layers • 4-4Layers • 5-5Layers 		<ul style="list-style-type: none"> • 12-DC12V • 24-DC24V • 110-AC110V • 220-AC220V 		<ul style="list-style-type: none"> ● R-Red ● A-Amber ● G-Green ● B-Blue ● W-White

QT70ML-BZ

Ø70mm Multi-Functional Modular LED Tower Lights with Buzzer

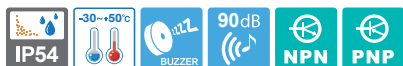

QT70ML-BZ

Color Options:

Beige color is available



Technical Diagram

(Units : mm)

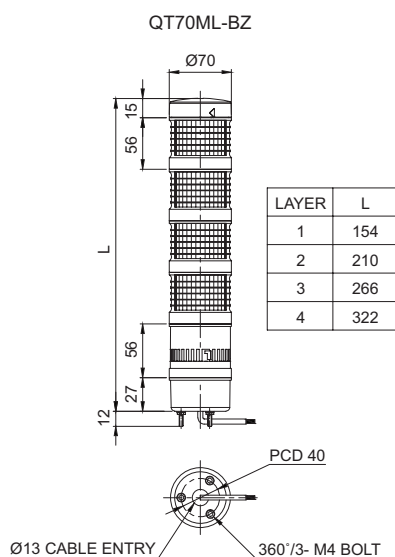

QT70ML-BZ Ø70mm Direct Mount Modular LED Tower Lights with Buzzer

Product consist of cover, LED modules, buzzer module, base module



Specifications

Model number	Layer	Voltage	Current	Certificates	Weight	Color
QT70ML-BZ QT70MLF-BZ (Max 90dB)	1	DC12V	0.115A	CE DC24V only	0.26kg	● R-Red
		DC24V	0.080A		0.26kg	
		AC110V	0.110A		0.27kg	
		AC220V	0.110A		0.27kg	
	2	DC12V	0.215A		0.34kg	● R-Red ● G-Green
		DC24V	0.130A		0.34kg	
		AC110V	0.130A		0.35kg	
		AC220V	0.130A		0.35kg	
	3	DC12V	0.315A		0.42kg	● R-Red ● A-Amber ● G-Green
		DC24V	0.180A		0.42kg	
		AC110V	0.150A		0.43kg	
		AC220V	0.150A		0.43kg	
	4	DC12V	0.415A		0.49kg	● R-Red ● A-Amber ● G-Green ● B-Blue
		DC24V	0.230A		0.49kg	
		AC110V	0.170A		0.50kg	
		AC220V	0.170A		0.50kg	

QT70L Steady Module + Base Module(MBS) + Buzzer(BZ)
 QT70LF Flashing Module

※ Please refer to page 105-108 for detailed specification of module.



Wiring Instructions

• LED tower light can be wired with external contact and transistor

※ Please refer to page 115 for detailed information about the wiring instructions.



Customization

- Beige color
- LED strobe (Model number : QT70MLS-BZ)
- LED simulated revolving (Model number : QT70MLR-BZ)
- Wall mount bracket :

Bracket structure allows for threading through the bracket hole or into the wall mount



Ordering Specification

QT70ML-BZ	-	3	-	220	-	RAG
[Model number]		[Layer]		[Voltage]		[Color]
<ul style="list-style-type: none"> • QT70ML-BZ • QT70MLF-BZ 		<ul style="list-style-type: none"> • 1-1Layer • 2-2Layers • 3-3Layers • 4-4Layers 		<ul style="list-style-type: none"> • 12-DC12V • 24-DC24V • 110-AC110V • 220-AC220V 		<ul style="list-style-type: none"> ● R-Red ● A-Amber ● G-Green ● B-Blue

QT70ML-W

Ø70mm Multi-Functional Modular LED Tower Lights with Signal Sound



QT70ML-W

Color Options:

Beige color is available



QT70ML-W Ø70mm Pole Mount Modular LED Tower Lights with Signal Sound

Product consist of cover, LED modules, signal sound module, base module

Specifications

Model number	Layer	Built-in Sound	Voltage	Current	Certificates	Weight	Color
QT70ML-WS QT70ML-WM QT70ML-WA QT70MLF-WS QT70MLF-WM QT70MLF-WA	1	WS-5 Warning sounds WM-5 Melodies WA-Alarms (Max 85dB)	DC12V	0.320A	CE DC24V only	0.37kg	● R-Red
			DC24V	0.180A		0.37kg	
	2		DC12V	0.420A		0.44kg	● R-Red ● G-Green
			DC24V	0.230A		0.44kg	
	3		DC12V	0.520A		0.54kg	● R-Red ● A-Amber ● G-Green
			DC24V	0.280A		0.54kg	
	4		DC12V	0.620A		0.59kg	● R-Red ● A-Amber ● G-Green ● B-Blue
			DC24V	0.330A		0.59kg	

QT70L Steady Module + Signal Sound Module
QT70LF Flashing Module + WS Warning sounds + Base Module(MBS)
 + WM Melodies
 + WA Alarms

* Please refer to page 105-108 for detailed specification of module.

* Please refer to page 186 for detailed sound specification.

Technical Diagram (Units : mm)

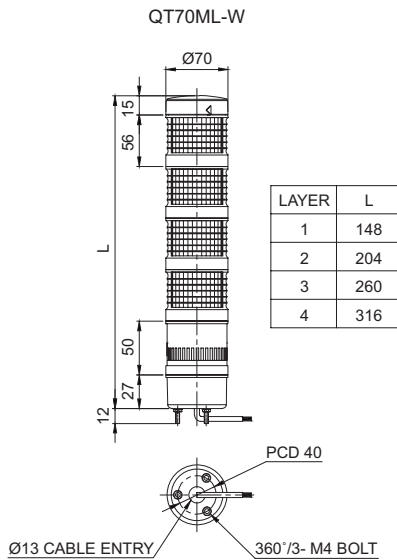

Wiring Instructions

• LED tower light can be wired with external contact and transistor

* Please refer to page 115 for detailed information about the wiring instructions.

Customization

- Beige color
- LED strobe (Model number : QT70MLS-W)
- LED simulated revolving (Model number : QT70MLR-W)
- Wall mount bracket :

Bracket structure allows for threading through the bracket hole or into the wall mount



Ordering Specification

QT70ML-WA	-	3	-	24	-	RAG
[Model number]		[Layer]		[Voltage]		[Color]
<ul style="list-style-type: none"> • QT70ML-WS • QT70ML-WM • QT70ML-WA • QT70MLF-WS • QT70MLF-WM • QT70MLF-WA 		<ul style="list-style-type: none"> • 1-1Layer • 2-2Layers • 3-3Layers • 4-4Layers 		<ul style="list-style-type: none"> • 12-DC12V • 24-DC24V 		<ul style="list-style-type: none"> ● R-Red ● A-Amber ● G-Green ● B-Blue

QT series

Multi-Functional Modular LED Tower Lights



Wiring Instructions

- QT series modular LED tower lights can be wired by external contact and transistor.
- Please follow below wiring instructions carefully.

Type	External Contact	Type	Transistor
DC/AC Standard QT50ML QT50MLF QT50MLS QT50MLR QT50L QT50LF QT50LS QT50LR QT70ML QT70MLF QT70MLS QT70MLR QT70L QT70LF QT70LS QT70LR	<p>EXTERNAL CONTACT</p> <p>Red(R) Layer 1 Amber(A) Layer 2 Green(G) Layer 3 Blue(B) Layer 4 White(W) Layer 5</p> <p>Black(BK) Fuse Power</p>	DC Standard QT50ML QT50MLF QT50MLS QT50MLR QT50L QT50LF QT50LS QT50LR QT70ML QT70MLF QT70MLS QT70MLR QT70L QT70LF QT70LS QT70LR	<p>EXTERNAL TRANSISTOR-NPN</p> <p>EXTERNAL TRANSISTOR-PNP</p> <p>Red(R) Layer 1 Amber(A) Layer 2 Green(G) Layer 3 Blue(B) Layer 4 White(W) Layer 5</p> <p>Black(BK) Fuse Power</p>
DC/AC Buzzer QT50ML-BZ QT50MLF-BZ QT50MLS-BZ QT50MLR-BZ QT50L-BZ QT50LF-BZ QT50LS-BZ QT50LR-BZ QT70ML-BZ QT70MLF-BZ QT70MLS-BZ QT70MLR-BZ QT70L-BZ QT70LF-BZ QT70LS-BZ QT70LR-BZ	<p>EXTERNAL CONTACT</p> <p>Red(R) Layer 1 Amber(A) Layer 2 Green(G) Layer 3 Blue(B) Layer 4 Brown(BN) Buzzer</p> <p>Black(BK) Fuse Power</p>	DC Buzzer QT50ML-BZ QT50MLF-BZ QT50MLS-BZ QT50MLR-BZ QT50L-BZ QT50LF-BZ QT50LS-BZ QT50LR-BZ QT70ML-BZ QT70MLF-BZ QT70MLS-BZ QT70MLR-BZ QT70L-BZ QT70LF-BZ QT70LS-BZ QT70LR-BZ	<p>EXTERNAL TRANSISTOR-NPN</p> <p>EXTERNAL TRANSISTOR-PNP</p> <p>Red(R) Layer 1 Amber(A) Layer 2 Green(G) Layer 3 Blue(B) Layer 4 Brown(BN) Buzzer</p> <p>Black(BK) Fuse Power</p>
DC/AC Built-in Sounder QT50ML QT50MLF QT50MLS QT50MLR QT50L QT50LF QT50LS QT50LR QT70ML QT70MLF QT70MLS QT70MLR QT70L QT70LF QT70LS QT70LR	<p>EXTERNAL CONTACT</p> <p>Red(R) Layer 1 Amber(A) Layer 2 Green(G) Layer 3 Blue(B) Layer 4 Gray(GR1) Ch 1 Sound Pattern Gray(GR2) Ch 2 Sound Pattern Gray(GR3) Ch 3 Sound Pattern Gray(GR4) Ch 4 Sound Pattern Gray(GR5) Ch 5 Sound Pattern Black(BK) Common White(W) Fuse Power</p> <p>• QTXX(M)L - Including WS/WM/WA type • QTXX(M)LF - Including WS/WM/WA type • QTXX(M)LS - Including WS/WM/WA type • QTXX(M)LR - Including WS/WM/WA type • QTXXL Lens Diameter 50(50mm) : QT50(M)L 70(70mm) : QT70(M)L</p>	DC Built-in Sounder QT50ML QT50MLF QT50MLS QT50MLR QT50L QT50LF QT50LS QT50LR QT70ML QT70MLF QT70MLS QT70MLR QT70L QT70LF QT70LS QT70LR	<p>EXTERNAL TRANSISTOR-NPN</p> <p>Gray(GR1) Ch 1 Sound Pattern Gray(GR2) Ch 2 Sound Pattern Gray(GR3) Ch 3 Sound Pattern Gray(GR4) Ch 4 Sound Pattern Gray(GR5) Ch 5 Sound Pattern Red(R) Layer 1 Amber(A) Layer 2 Green(G) Layer 3 Blue(B) Layer 4 Black(BK) Common White(W) Fuse Power</p> <p>• QTXX(M)L - Including WS/WM/WA type • QTXX(M)LF - Including WS/WM/WA type • QTXX(M)LS - Including WS/WM/WA type • QTXX(M)LR - Including WS/WM/WA type • QTXXL Lens Diameter 50(50mm) : QT50(M)L 70(70mm) : QT70(M)L</p>
DC/AC Built-in Sounder Internal Switch QT50ML QT50MLF QT50MLS QT50MLR QT50L QT50LF QT50LS QT50LR QT70ML QT70MLF QT70MLS QT70MLR QT70L QT70LF QT70LS QT70LR	<p>EXTERNAL CONTACT</p> <p>Red(R) Layer 1 Amber(A) Layer 2 Green(G) Layer 3 Blue(B) Layer 4 Brown(BN) Sound Pattern</p> <p>Black(BK) Fuse Power</p> <p>• QTXX(M)L - Including WS/WM/WA type • QTXX(M)LF - Including WS/WM/WA type • QTXX(M)LS - Including WS/WM/WA type • QTXX(M)LR - Including WS/WM/WA type • QTXXL Lens Diameter 50(50mm) : QT50(M)L 70(70mm) : QT70(M)L</p>	DC Built-in Sounder Internal Switch QT50ML QT50MLF QT50MLS QT50MLR QT50L QT50LF QT50LS QT50LR QT70ML QT70MLF QT70MLS QT70MLR QT70L QT70LF QT70LS QT70LR	<p>EXTERNAL TRANSISTOR-NPN</p> <p>Red(R) Layer 1 Amber(A) Layer 2 Green(G) Layer 3 Blue(B) Layer 4 Brown(BN) Sound Pattern</p> <p>Black(BK) Fuse Power</p> <p>• QTXX(M)L - Including WS/WM/WA type • QTXX(M)LF - Including WS/WM/WA type • QTXX(M)LS - Including WS/WM/WA type • QTXX(M)LR - Including WS/WM/WA type • QTXXL Lens Diameter 50(50mm) : QT50(M)L 70(70mm) : QT70(M)L</p>

ООО "РусАвтоматизация"

454010 г. Челябинск, ул. Гагарина 5, оф. 507

тел. 8-800-775-09-57 (звонок бесплатный), +7(351)799-54-26, тел./факс +7(351)211-64-57

info@rusautomation.ru; rusautomation.ru; www.rusautomation.ru