

**Both built-in sounds and option for external sound input via SDcard (MP3) have 30 built-in sounds**  
**Able to avoid signal confusion with a variety of tone options**

- Bit Input offers 5 channels with 6 sound outputs
- Binary Input offers 30 sound outputs
- SDcard (MP3) combination



### QMPS QMPS Panel Embedded Multifunctional Speaker (SDcard/ MP3 Type)

- Can prevent cross talk of different voice environments by selecting an audio signal fit for the specific environment and condition
- Offers both Binary and Bit input mode options with 30 pre-recorded sounds
- Binary input mode has built-in 30 messages that can be played with switch for sound selection
- Bit input mode is organized into 6 groups of 5 sound tones for a total of 30 sound tone options. Playback can be selected from one of the 5 tones in each group (MP3 file with bit input mode)
- Volume adjustment and sound selection switches located inside the unit
- SDcard type can play MP3 voice messages, user can select and change the sound message after record it
- Sound volume : Max 98dB at 1m
- Materials : Housing-ABS, Cover-ABS
- Ambient operating temperature : -25°C to +50°C
- Protection rating : IP54
- Certificates : CE Compliant, UL Listed
- Compliant with RoHS directive

#### • Features

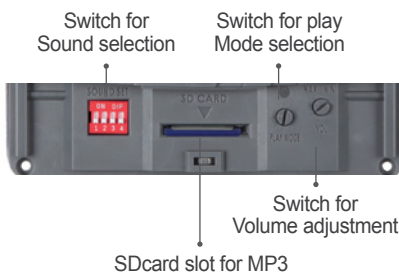

#### Sound Selection Instruction for SDcard Type

You can select between pre-recorded sound mode and SDcard sound (MP3) mode with the SOUND selection switch

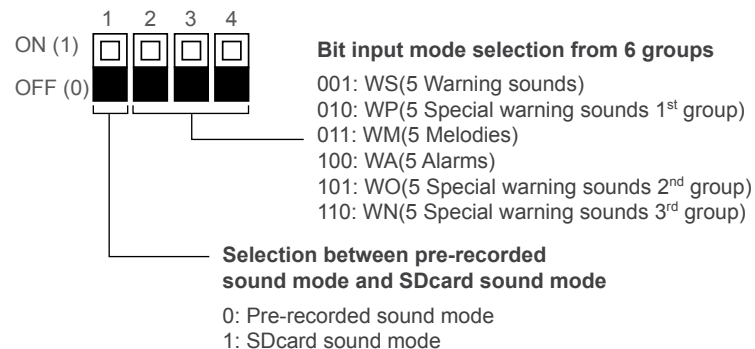

#### SDcard(MP3) Type



You can easily rearrange the sound playback and group arrangement with PC.  
 Capacity is 32Gbyte.  
 \* SDcard sold separately.

- 30 pre-recorded sounds offered (5 warning sounds, 5 special warning sounds 1<sup>st</sup> group, 5 melodies, 5 alarms, 5 special warning sounds 2<sup>nd</sup> group, 5 special warning sounds 3<sup>rd</sup> group)
- External MP3 sound support (SDcard)
- Binary input : 30 channels
- Bit input : 5 channels (6 sound groups)
- A multi-functional product that can use an SDcard for MP3 playback
- Details on how to setup the multi-functional speakerphone are on page 26

# QMPS

## Panel Mounted Multifunctional Speaker



### QMPS Max. 98dB, Panel Mounted Multifunctional Speaker

Model number	Voltage	Current	dB	Input Method/ No. of Ch	Certificate	Weight
QMPS	DC12V-24V	Max 0.750A	• Warning : 98dB • MP3 : 95dB	Bit Input : 5Ch Binary Input : 30Ch	CE	0.35kg
	AC110V-220V	Max 0.100A			UL	0.53kg

※ DC type model has a free-voltage range of DC10V-30V.  
 ※ AC type model has a free-voltage range of AC100V-240V.



#### Technical Diagram

(Units : mm)



QMPS

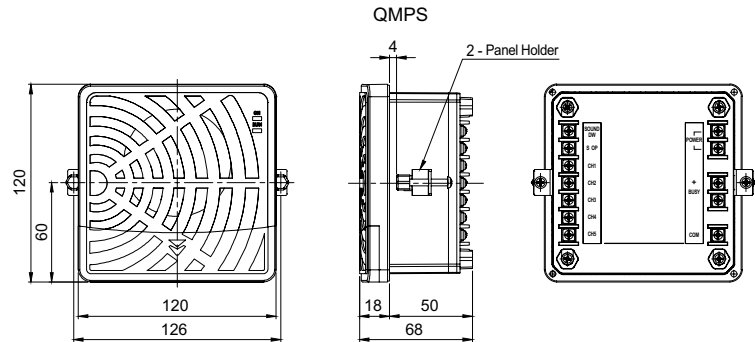

#### Wiring Instructions

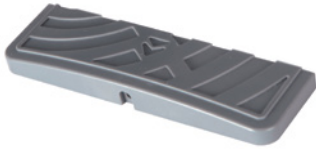

Terminal box for wiring both power and sound pattern(Rear)

#### QMPS DC

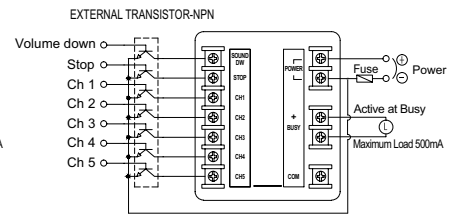
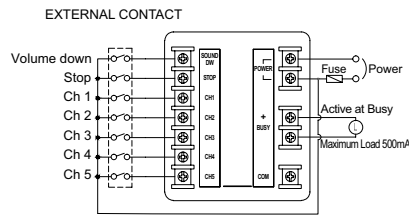

#### QMPS AC

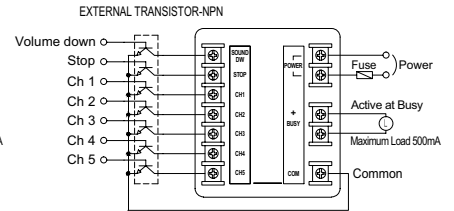
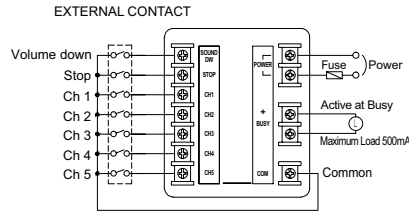

• In case of bits input, 5 sound tones can be played. For Binary input, 30 sound tones can be played.

※ Please refer to page 26 for detailed channel input instructions.  
 (Wiring instruction is substituted for channel selection switch)



#### Ordering Specification

<b>QMPS</b>	-	<b>12/24</b>
[Model number]		[Voltage]
• QMPS		• 12/24-DC12V-24V • 110/220-AC110V-220V