

# NIVOROTA

ROTARY PADDLE LEVEL SWITCH



3 YEARS WARRANTY

# NIVELCO

LEVEL SWITCHES

## DESCRIPTION

**NIVOROTA** rotary paddle level switches detect the level of lumpy substances, powders, grains, or granules. Mounted onto tanks, silos, or hoppers, it monitors and controls the filling and dumping of stored materials, such as stone, ash, sand, coal, feed, beet slices, etc.

A small electric motor drives the paddle, which rotates freely in the absence of material. When the material reaches the paddle, the motor is switched off, and the output switch is triggered. When the material level drops, the paddle is free to spin again, the motor is reactivated, and the switch returns to its original state. The NIVOROTA E-700 & E-800 series Rotary Paddle Level Switches provide all the advantageous features of the previous series in one unit. Dust Ex versions are available for use in hazardous environments.

## FEATURES

- Level switching of free-flowing solids
- Extension cable or rod up to 3 m (10 feet)
- Automatic motor shutdown
- High-temperature version
- IP67
- Dust-Ex certified version
- Rotary force independent of the supply voltage
- Low supply voltage is indicated by a blinking LED

## CERTIFICATES

- ATEX (Ex ta/tb D)
- EAC Ex (Ex tb D)

## VARIANTS

To select the appropriate model, follow these considerations:

- **Insertion length:** the application (low or high level switching) and the position of the device determine the insertion length.
- **Number of blades:** specific gravity and particle size of the material help determine the number of blades necessary. Most commonly used is the stainless steel, single-blade paddle. It can be passed through a threaded process connection. For lighter materials, the use of a 3-blade paddle is recommended. The available devices have 1- or 3-blades, but they can be ordered with either paddle variant, and the paddles can be ordered separately as well.
- **Flexible coupling:** use if the shaft of the instrument has to be protected against falling materials (rocks, larger lumpy materials).

## APPLICATIONS

- **Food industry:**  
sunflower seeds, sunflower hulls, coffee and, cocoa powder, flour, sugar, etc.
- **Chemical industry:**  
plastic powders, granules, pellets
- **Building industry:**  
cement, sand, calcium powder, gypsum
- **Energy industry:**  
active soot, coal powder, fly ash

## TYPE SELECTION

	E-700	E-800
Metal housing	■	-
Plastic housing	-	■
Single-blade paddle	■	■
Multi-blade paddle	■	■
Flexible coupling	■	■
Cable length	■	■
DC power supply	■	■
Dust Ex version	■	-
High-temperature version	■	-
1" process connection	■	■
1½" process connection	■	■
Torque adjustment	■	■

Material	Density (kg/dm <sup>3</sup> ) <sup>(1)</sup>
Wheat	0.4-0.5
Flour	0.6-0.8
Wood chip	0.3-0.4
Sawdust	0.3-0.35
Lime dust	0.8-1
Lime hydrate dust	0.4-0.5
PVC dust	0.3-0.6
PVC granule	0.3-0.6
Sunflower seeds	0.3-0.5
Sunflower hulls	0.1-0.2
Feed	0.2-0.6
Ground paprika	0.8-1

(1) Informational data



EL-700  
Single-blade paddle  
with flexible coupling

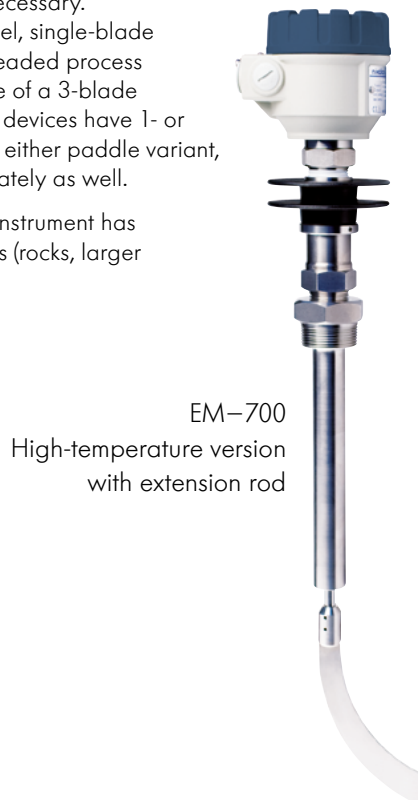

EM-700  
High-temperature version  
with extension rod



EL-700  
3-blade paddle  
version









## TECHNICAL DATA

	Standard version		High-temperature version
	EL□-7□□	EL□-8□□	EM□-7□□
Insertion length	Standard: 200 mm (7.85 inches); probe extension rod: 0.3–3 m (0.98–10 feet); cable extended probe: 1–3 m (3.3–10 feet)		
Paddle material, number of blades	1.4571 (316Ti) stainless steel / 1, 2, 3; as per order code		
Rotation speed	~1 rpm (@50 Hz)		
Material of wetted parts	1.4571 (316Ti) stainless steel, Material of the seal: NBR		1.4571 (316Ti) stainless steel, Material of the seal: FPM
Medium density (guideline value)	Minimum 0.1 kg / dm <sup>3</sup>		
Medium temperature	-20°C...+120°C (-4°F...+248°F)	-20°C...+80°C (-4°F...+176°F)	-20°C...+200°C (-4°F...+392°F)
	Ex variant: see Ex Information		
Ambient temperature / relative humidity	-30°C...+60°C (-22°F...+140°F) / maximum 90%		
Process pressure	Maximum 3 bar (0.3 MPa [43.5 psig])		
Output	SPDT 250 VAC, 6A, AC1		
Paddle-rotation / shutdown indication	Two-toned (green/red) LED		
Process connection	1" BSPT; 1½" BSPT; mounting plate (BSPT thread can also be screwed into BSP or NPT thread)		
Power supply	230 VAC, 120 VAC, 24 VAC, 24 VDC (18–28 VDC)		
Power consumption	Maximum 4 VA (4 W)		
Electrical connection	2× M20x1.5 plastic cable glands, for 6–12 mm cable (0.25–0.5 inches) + Two internally threaded ½" NPT connection for protective pipes 2× terminal blocks for 0.5–1.5 mm <sup>2</sup> (AWG20–AWG15) wire cross section		
Electrical protection	Class I		
Ingress protection	IP67		
Housing material	Powder-coated aluminum or plastic (PBT)		Powder-coated aluminum
Weight	Standard: 1.6 kg (3.52 lb); with extension rod: 1.6 kg + extension 1.6 kg/m (1 lb/ft); with extension cable: 2.6 kg (5.73 lb) + extension 1.4 kg/m (0.94 lb/ft), counterweight: 1 kg (2.2 lb)		

## Ex INFORMATION

	E□□-7□□-□Ex							
Protection type	Dust Ex							
Ex marking	Ⓔ II 1/2 D Ex tb IIIC IP67							
Electrical connection	2× M20x1.5 metal cable glands for Ø6–12 mm (0.31–0.51 inches) cable							
Temperature data	Standard version			High-temperature version				
Temperature class	T85°C	T100°C	T135°C	T85°C	T100°C	T135°C	T200°C	
Highest surface temperature	85°C	100°C	120°C	85°C	100°C	120°C	200°C	
Medium temperature	85°C	100°C	120°C	85°C	100°C	120°C	200°C	
Waiting time for opening the cover	30 min.	20 min.	5 min.	30 min.	20 min.	5 min.	0 min.	

## OPERATING MODES

Power supply	Status LED	Output microswitch	Paddle
ON		 De-Energized	Rotates
		 Energized	Does not rotate
OFF		 De-Energized	Does not rotate

## MOUNTING

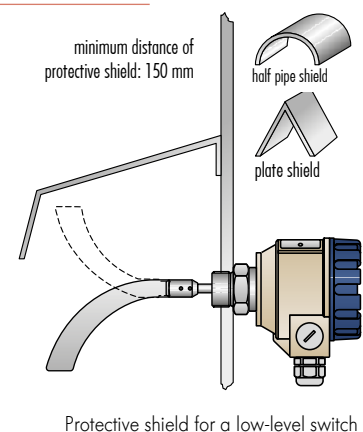

## PADDLES, ACCESSORIES

### Single-blade, curved paddle (168 mm [6.6"]), EAL-701-1

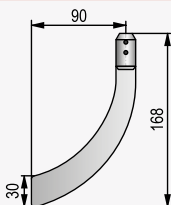

- Inserted through a 1", 45 mm (1.75 inches) long process connection.
- Default blade, for most applications.

### Single-blade, curved paddle (120 mm [4.7"]), EAL-702-1

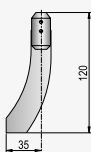

- Inserted through a 1", 45 mm (1.75 inches) long process connection.
- For coarse or sticky materials. The material stuck to the blade tends to affect the operation of the unit less.
- More robust due to the blade's small area and insertion length.

### Single-blade, 90° paddle (130 mm [5.1"]), EAL-707-1

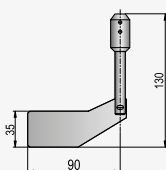

- Inserted through a 1½", 50 mm (2 inches) long process connection.
- For light materials due to its large blade.

### Single-blade, straight paddle (170 mm [6.7"]), EAL-705-1

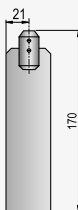

- Inserted through a 1½" process connection.
- For coarse or sticky materials. The material stuck to the blade tends to affect the operation of the unit less.

### Single-blade, straight paddle (70 mm [2.75"]), EAL-706-1

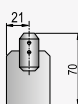

- For dense materials.
- More robust due to the blade's small area and insertion length.
- Inserted through a 1½" process connection.

### Flexible Coupling, EAS-701-0

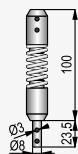

- To protect the paddle from strong dynamical effects that may occur during operation.

### Pipe extension (Ø10x1), EAR-70□-1<sup>(2)</sup>

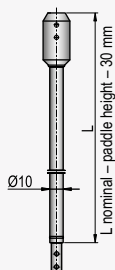

### Rigid pipe for cable extended version, EAK-70□□-1<sup>(2)</sup>

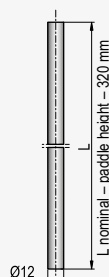

<sup>(2)</sup> Coding of length in accordance with the "Insertion Length" column of the Order Code table

## PADDLES, ACCESSORIES

### 3-blade, standard paddle (120 mm [4.7"]), EAL-709-1<sup>(1)</sup>

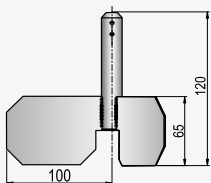

- Primarily for light materials due to its large blade.
- Use a mounting plate to insert paddle into the tank!

### 3-blade, extended paddle (268 mm [10.5"]), EAL-708-1<sup>(1)</sup>

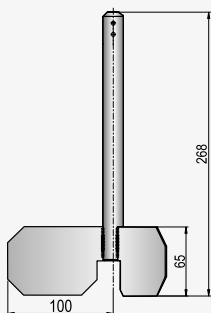

- Primarily for light materials due to its large blade.
- Extended variant.
- Use a mounting plate to insert paddle into the tank!

### 2-blade, flexible paddle (172 mm [6.8"]), EAL-703-1

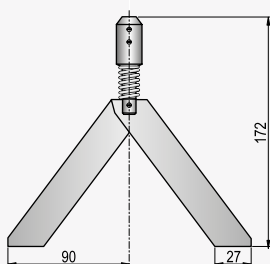

- Can be inserted even through a 1", 90 mm (3.5 inches) long process connection.
- Paddle cannot be used with sticky materials, as they may prevent the blades from closing when removing.
- The blades must be closed by pressing the blade tips together when the unit is installed.

### 2-blade, flexible paddle (120 mm [4.7"]), EAL-704-1

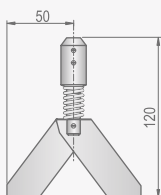

- For materials with a larger specific weight.
- Can be inserted even through a 1", 90 mm (3.5 inches) long process connection.
- Paddle cannot be used with sticky materials, as they may prevent the blades from closing when removing.
- The blades must be closed by pressing the blade tips together when the unit is installed.

### Mounting plate, EAM-70□-0

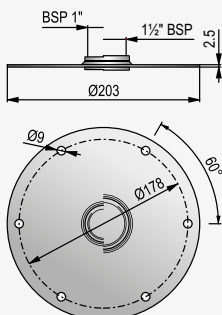

- Stainless steel and carbon steel variant available. The latter is electrostatic powder-coated to prevent rusting.

<sup>(1)</sup> With a mounting plate

## DIMENSIONS

Standard version		Rod extended version	
Single-blade paddle EL□-, EK□-□02-□	3-blade paddle ELF-, EK□-□02-□	Single-blade paddle ELR-, EKR-	
Cable extended version with counterweight		High-temperature version	
Single-blade paddle EKK-, ELK-	3-blade paddle EKL-, ELL-	EM□-, EH□-7□□-□	
			Standard 1 or 3-blade paddle, rod or cable version

## ORDER CODES (NOT ALL COMBINATIONS AVAILABLE)

NIVOROTA E ■ ■ ■ - ■ ■ ■ - ■ (1)

Version	Code	Ház anyaga	Code	Code	Insertion length	Code	Power supply / Certificate	Code
Standard bidirectional	L	Aluminum	7	0	0 m	0	230 VAC	1
High-temperature, bidirectional	M	Plastic <sup>(2)(3)</sup>	8	1	1 m	0.1 m	120 VAC	2
				2	2 m	0.2 m	24 VAC	3
				3	3 m	0.3 m	24 VDC	4
						0.4 m	230 VAC / Ex tb IIIC (ATEX)	5
						0.5 m	120 VAC / Ex tb IIIC (ATEX)	6
						0.6 m	24 VAC / Ex tb IIIC (ATEX)	7
						0.7 m	24 VDC / Ex tb IIIC (ATEX)	8
						0.8 m		
						0.9 m		

## AVAILABLE PARTS & ACCESSORIES

The properties of most accessories can be found in the brochure, but the full list of available parts and accessories is in the NIVELCO Selector and the user manual of the devices.

## ООО “РусАвтоматизация”

454010 г. Челябинск, ул. Гагарина 5, оф. 507  
 тел. 8-800-775-09-57 (звонок бесплатный), +7(351)799-54-26, тел./факс +7(351)211-64-57  
[info@rusautomation.ru](mailto:info@rusautomation.ru); [rusavtomatizatsiya.pф](http://rusavtomatizatsiya.pф); [www.rusautomation.ru](http://www.rusautomation.ru)