

PULSE METER MP5W SERIES

M A N U A L



Thank you very much for selecting Autonics products.
For your safety, please read the following before using.

Caution for your safety

※Please keep these instructions and review them before using this unit.

※Please observe the cautions that follow;

Warning Serious injury may result if instructions are not followed.

Caution Product may be damaged, or injury may result if instructions are not followed.

※The following is an explanation of the symbols used in the operation manual.

⚠caution: Injury or danger may occur under special conditions.

Warning

1. In case of using this unit with machinery(Ex: nuclear power control, medical equipment, ship, vehicle, train, airplane, combustion apparatus, safety device, crime/disaster prevention equipment, etc) which may cause damages to human life or property, it is required to install fail-safe device.

It may cause a fire, human injury or damage to property.

2. It must be mounted on panel.

It may give an electric shock.

3. Do not repair or check up when power on.

It may give an electric shock.

4. Do not disassemble and modify this unit, when it requires.

If needs, please contact us.

It may give an electric shock and cause a fire.

5. Please check the number of terminal when connect power line or measuring input.

It may cause a fire.

Caution

1. This unit shall not be used outdoors.

It might shorten the life cycle of the product or give an electric shock.

2. When wire connection for power input and measuring input, the tightening strength for screw bolt on terminal block should be over than 0.74N.m~0.90N. m.

It may result in malfunction or fire due to contact failure.

3. Please observe specification rating.

It might shorten the life cycle of the product and cause a fire.

4. Do not use the load beyond rated switching capacity of Relay contact.

It may cause insulation failure, contact melt, contact failure, relay broken, fire etc.

5. In cleaning the unit, do not use water or an oil-based detergent.

It might cause an electric shock or fire that will result in damage to this product.

6. Do not use this unit at place where there are flammable or explosive gas, humidity, direct ray the sun, radiant heat, vibration, impact etc.

It may cause a fire or explosion.

7. Do not inflow dust or wire dregs into inside of this unit.

It may cause a fire or mechanical trouble.

8. Please connect properly after checking the polarity of measuring terminals.

It may cause a fire or explosion.

※The above specification are changeable without notice anytime.

Ordering information

MP	5	W	-	4	N
Item	Size	Digit	Output	Power supply	
					2 24VDC
					4 100~240VAC 50/60Hz
					W DIN W96 X H48mm
					5 99999(5 Digit)
					MP Pulse meter

	Main output (Comparative value output)	Sub output (Display value output)
N	Indicator	-
A	Relay five-stage(HH, H, GO, L, LL)	-
1	Relay three-stage(H, GO, L)	-
2	NPN open collector quintuple output	BCD Dynamic
3	PNP open collector quintuple output	BCD Dynamic
4	NPN open collector quintuple output	PV transmission output (DC4-50mA)
5	PNP open collector quintuple output	PV transmission output (DC4-50mA)
6	NPN open collector quintuple output	Low speed serial output
7	PNP open collector quintuple output	Low speed serial output
8	NPN open collector quintuple output	RS485 communication
9	PNP open collector quintuple output	RS485 communication

※PNP open collector output: Option

Specifications

Series	MP5W-2□	MP5W-4□
Display method	7 Segment LED(Zero Blanking)	
Character size	W7 X H14mm	
Max. indication	5digit(-19999 to 99999)	
Power supply	24VDC	100-240VAC 50/60Hz
Allowable operation voltage	90 to 110% of rated voltage	
Power consumption	Max. 7W	Max. 6VA
Power for external sensor	12VDC ± 10%, 80mA	
Input frequency	<ul style="list-style-type: none"> Solid state input : Max. 50kHz(Pulse width:Min. 10μs) Contact input : Max. 45Hz(Pulse width:Min. 11ms) 	
Input level	[Voltage input] High: 4.5-24VDC, Low: 0-1VDC, [No-voltage input] Residual voltage: Max. 1V	
Measuring range	<ul style="list-style-type: none"> Mode F1, F2, F7, F8, F9, F10 : 0.0005Hz to 50kHz Mode F3: 0.02s to 3,200s Mode F4, F5, F6: 0.01s to 3,200s Mode F11, F12, F13: 0 to 4 X10⁹ Count 	
Measuring accuracy (23 ± 5°C)	<ul style="list-style-type: none"> Mode F1, F2, F7, F8, F9, F10: F.S. ± 0.05% rdg ± 1Digit Mode F3, F4, F5, F6: F.S. ± 0.01% rdg ± 1Digit 	
Display accuracy	0.05 / 0.5 / 1 / 2 / 4 / 8sec.(The same as update output cycle)	
Operation mode	Number of revolution/Speed/Frequency(F1), Passing speed(F2), Cycle(F3), Passing time(F4), Time width(F5), Time difference(F6), Absolute rate(F7), Error ratio(F8), Density(F9), Error(F10), Length measurement(F11), Interval(F12), Integration(F13)	
Prescale function	Direct input method(0.0001X10 ⁹ to 9.9999X10 ⁹)	
Hysteresis	0 to 9999※1	
Other functions	<ul style="list-style-type: none"> Lock setting function Auto-Zero time setting function Current output range selection(Current output type only) Comparative output function(HH, H, GO, L, LL) Deviation memory function(F output mode applied only) Peak value monitoring value Remote/Local switching function(Communication output type only) Data Bank switching function Memory protection function(Mode F13 applied only) Monitoring delay function Time unit selection function 	
Main output	Triple/Quintuple relay	250VAC 3A resistive load 3a
	NPN open collector quintuple output	12-24VDC 30mA Max.
	PNP open collector quintuple output	
Sub output	BCD Dynamic	NPN open collector 12-24VDC 20mA Max.
	Low speed serial output	NPN open collector 12-24VDC 20mA Max.
	PV transmission	DC4-20mA Load 600Ω Max.(Response time: Max. 800ms)
	RS485 com.	32 channels, Mutual direction communication function
Memory	Non-volatile memory(Input times: 100,000 times)	
Insulation resistance	Min. 100MΩ (at 500VDC megger) between terminal and case	
Dielectric strength	2000VAC 60Hz 1minute(Between terminals of AC power and case, Between terminals of AC power and measuring terminals)	
Impulse noise strength	± 2000V the square wave noise(pulse width:1μs) by the noise simulator	
Vibration	Mechanical	0.75mm amplitude at frequency of 10 to 55Hz in each of X, Y, Z directions for 2 hour
	Malfunction	0.5mm amplitude at frequency of 10 to 55Hz in each of X, Y, Z directions for 10 minutes
Shock	Mechanical	300m/s ² (Approx. 30G) 3 times at X, Y, Z direction
	Malfunction	100m/s ² (Approx. 10G) 3 times at X, Y, Z direction
Relay life cycle	Mechanical	Min. 10,000,000 operations
	Electrical	Min. 100,000 times at 250VAC 3A(resistive load)
Environment	Ambient temperature	-10 to 50°C, Storage temperature: -20 to 60°C
	Ambient humidity	35 to 85%RH, Storage humidity: 35 to 85%RH
Approval	CE, RUUS	
Unit weight	Approx. 230g	

※Condition for use in environment is no freezing or condensation.
※1: The hysteresis setting range is changed by the setting position of decimal point.

Connections

<Main terminal block>

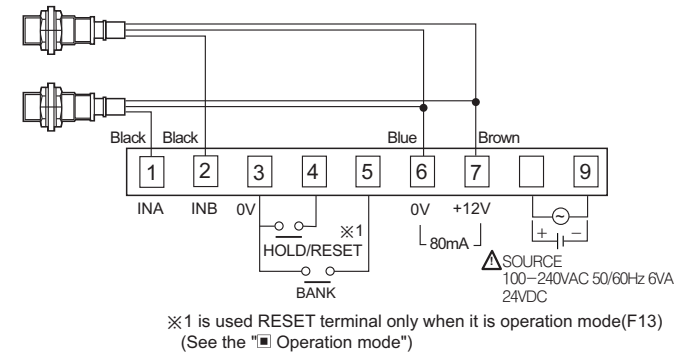

<Sub(Optional) terminal block>

•RELAY(Five-stage) output [MP5W-4A]

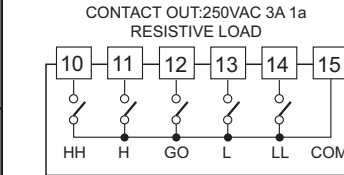

•RELAY(Three-stage) output [MP5W-41]

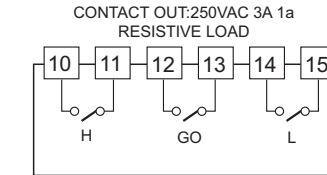

<Sub(Optional) output connector>

•NPN/PNP open collector output + BCD output [MP5W-42/MP5W-43]

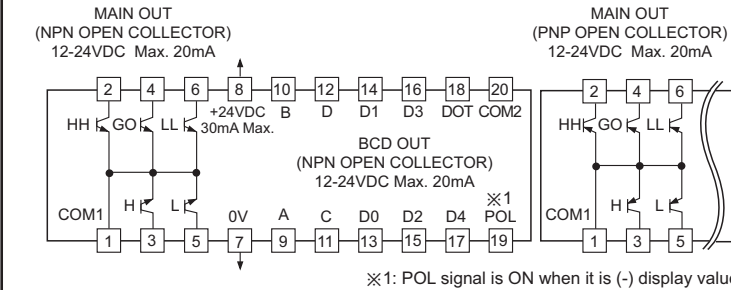

•NPN/PNP open collector output + PV transmission(4-20mADC) output[MP5W-44/MP5W-45]

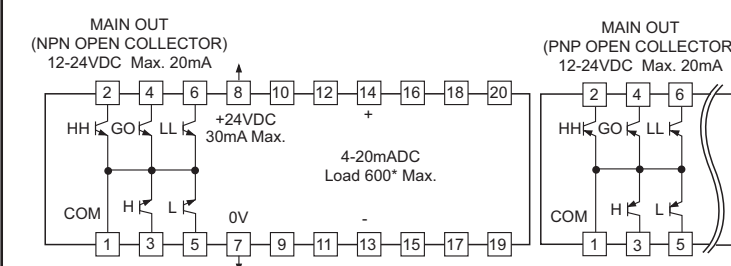

Dimensions

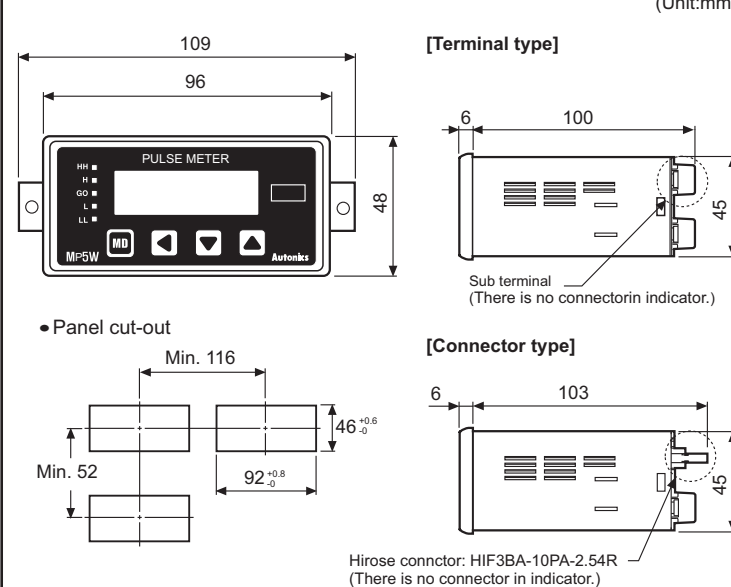

•NPN/PNP open collector output + Low speed serial output[MP5W-46/MP5W-47]

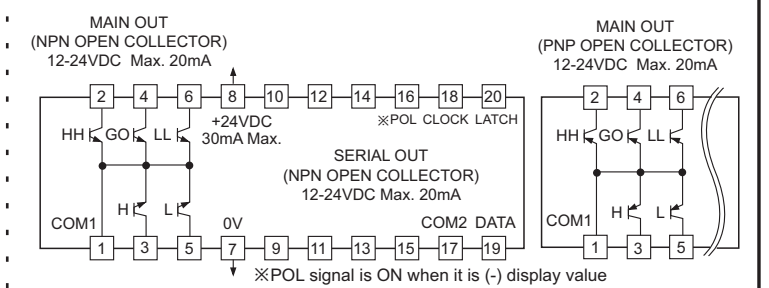

•NPN /PNP open collector output + RS485 communication output [MP5W-48/MP5W-49]

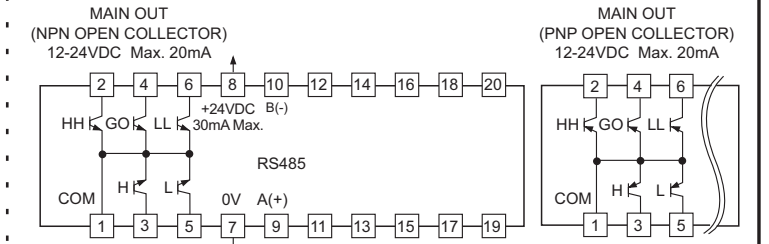

Input/Output

1. Input specification

1. Input signal

(1)Solid state input

①Input frequency: 50kHz(Max.)

But, standard duty rate of input signal is 1:1, ON/OFF pulse width should be each over 10μs.

②Input voltage Level : ON voltage → 4.5-24V, OFF voltage → 0-1.0V

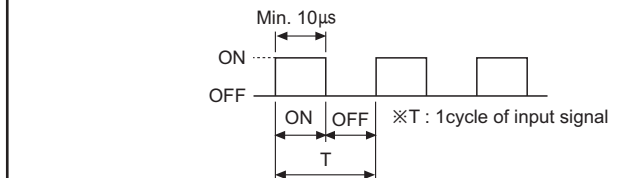

(2)Relay contact input

①Input frequency: 45Hz(Max.)

But, ON/OFF pulse width should be each over 11ms. ②Relay contact specification: Please use a contact that can switch reliably at 12VDC, 2mA min. of load current.

2. Input type

MP5W has NPN input and PNP input and it is able to select it in Parameter 1 group.

(1)NPN input type

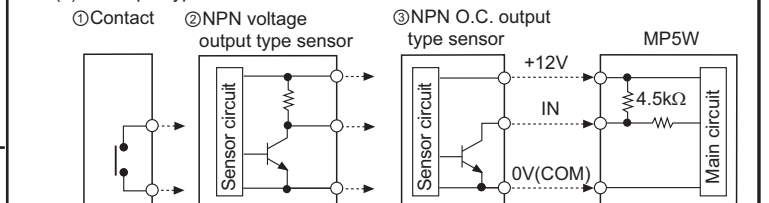

(2)PNP input type

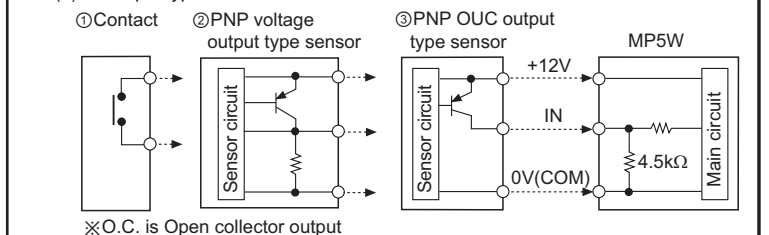

•Output specification

1. Relay output

①Output : Comparative or alarm output(See the "Output mode")

②Output method : Relay

③Contact capacity : 250VAC 3A resistive load

④Life cycle : Mechanical-20million times(Switch times 180 times/min.) Electrical-Min.100,000 times(3A 250VAC at resistive load) (Switch times : 20 times/min.)

2. TR output

①Output : Comparative or alarm output(See the "Output mode")

②Output method : NPN / PNP Open collector

③Rated load voltage : 12-24VDC

④Max. load current : 20mA

3. BCD Dynamic output

- Output: Display value
 - Output signal: BCD Data(A, B, C, D, DOT) ← A: Lowest bit, Dot: Highest bit
Digit Data(D0, D1, D2, D3, D4) ← D0: Lowest digit, D4: Highest digit
 - Output type: NPN Open Collector
 - Rated load voltage: 12-24VDC
 - Max. load current: 20mA
- Ex) When display value is 125.89

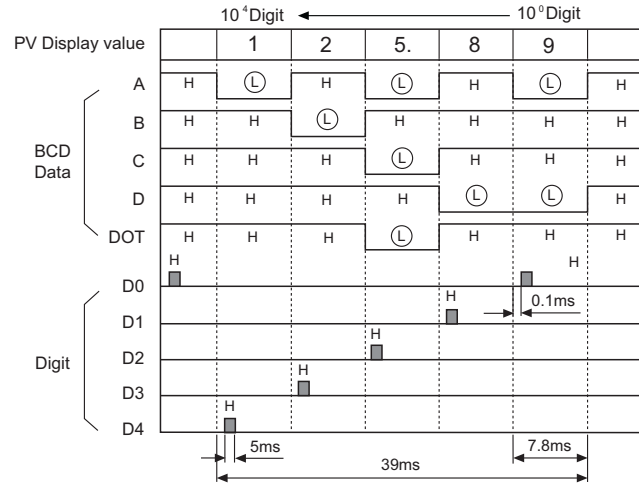

4. Low speed serial output

- Output: Display value
- Output signal: Clock, Data, Latch
- Clock cycle: 50Hz
- Output Clock bit: 25 bit
- Output Data bit: 25 bit
- Output form: NPN Open Collector
- Rated load voltage: 12-24VDC
- Max. load current: 20mA

Serial transmission time diagram

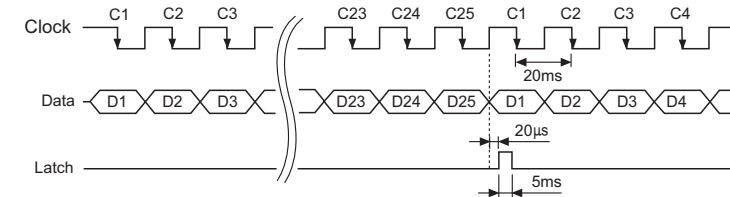

Data output sequence when it is serial transmission

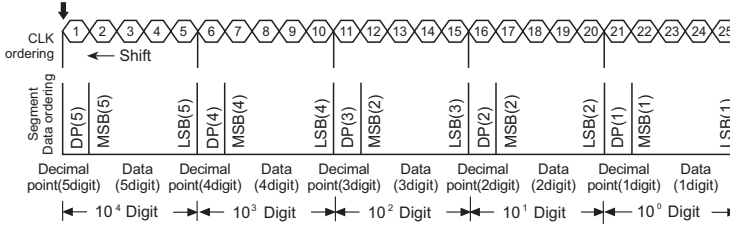

5. PV transmission output(4-20mAADC)

- Application : To transmit the measured value
- Function : This function is to transmit 4-20mAADC converted from measured display value between High limit output(FS-H) and Low limit(FS-L).
- Range of High/Low limit output setting
-High limit setting range(FS-H):From min. to max within range of measurement
-Low limit setting range(FS-L):From min. to max within range of measurement (FS-H should be over "1" bigger than FS-L)
- Resistive load : Max. 600Ω
- Resolution : 8000 division

If set FS-L and FS-H in certain section, the output will be 4-20mAADC.

Revolution between FS-L and FS-H is 8000, therefore if display value is narrower than 8,000 the resolution will be low.

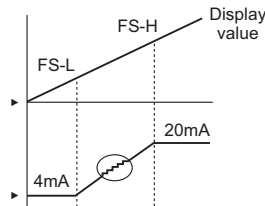

6. RS485 communication output

- Address: 0 ~ 99 address(32 channel)
- Transmission speed(Baud rate): 2400/4800/9600 bps
- Transmission code: ASCII
- Parity Bit: No
- Data Bit: 8 Bit
- Stop Bit: 1 Bit
- Communication items
-MP5W ← PC: Comparative value of each bank data, Prescale value and Peak value, RESET control
-MP5W → PC: Comparative value of each bank data, Prescale value and Peak value, Display value

Operation mode

- Select operation mode from **mode**(mode) of Parameter 1 group.
- There are 13 kinds of operation mode in this unit.

Mode F1(Frequency/Number of revolution/Speed)

This mode is to display calculated frequency or number of revolution, speed by measuring frequency of Input A.

- Frequency(Hz) = $f \times \alpha$ ($\alpha = 1[\text{sec}]$)
 - Number of revolution(rpm) = $f \times \alpha$ ($\alpha = 60[\text{sec}]$)
 - Speed(m/min) = $f \times \alpha$ ($\alpha = 60L[\text{sec}]$)
- ※L = The length of conveyor moved for 1 pulse cycle[m]

Display value and display unit

Display value	Display unit	α (Prescale value)
Frequency	Hz	1
	kHz	0.001
Number of revolution	rps	1
	rpm	60
Speed	mm / sec	1,000L
	cm / sec	100L
	m / sec	L
	m / min	60L
	km / hour	3.6L

Time chart

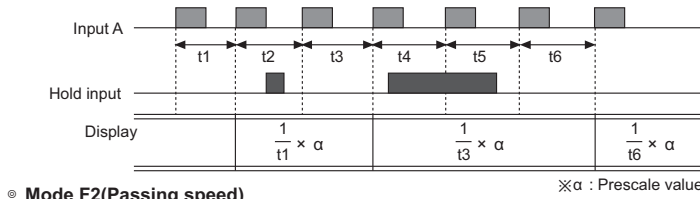

Mode F2(Passing speed)

It displays the passing speed between ON of input A and ON of input B.
Passing speed(V) = $f \times \alpha$ ($\alpha = L[\text{m}]$)
※f : This is reciprocal number of the time between ON of input A and ON of input B
L : The distance between input A and input B[m]

Display value and display unit

Display value	Display unit	α (Prescale value)
Passing speed	mm / sec	1,000L
	cm / sec	100L
	m / sec	L
	m / min	60L
	km / hour	3.6L

※Display unit of factory default : m/sec

Time chart

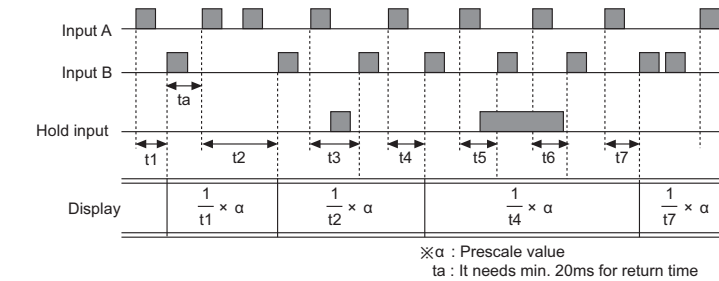

Mode F3(Cycle)

It displays the time from when input A is ON to the next ON of input A.
Cycle(T) = t
※t: Measurement time[sec]

Display value and display unit

Display value	Display unit	MIN
Cycle	SEC	999.99min.
	999.99sec.	9999.9min.
	99min.	99hour 99min.
	59.9sec.	59.9min.
	9hour 59min. 59sec.	999hour 59min. 59sec.
	99999sec.	99999min.

※Set the display unit at the **Unit**(Time unit) of Parameter 2.
※Display unit of factory default : 999.99sec.

Time chart

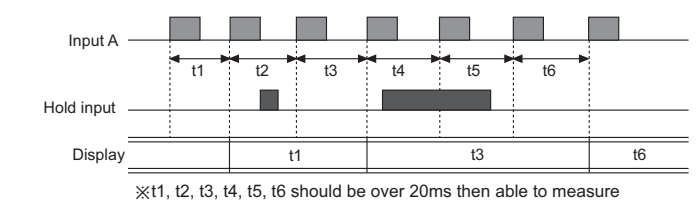

※t1, t2, t3, t4, t5, t6 should be over 20ms then able to measure

Mode F4(Passing time)

It displays the passing time of certain distance as measuring the time between ON and the next ON of Input A.

$$\text{Passing time[sec]} = t \times \alpha \quad (\alpha = \frac{L[\text{m}]}{\text{Moving distance within 1 pulse cycle[m]}})$$

Display value and display unit

Display value	Display unit	MIN
Passing time	SEC	999.99min.
	999.99sec.	9999.9min.
	99hour 59.9sec.	99hour 59.9min.
	9hour 59min. 59sec.	999hour 59min. 59sec.
	99999sec.	99999min.

※Display unit of factory default : 999.99sec.
※Set the display unit at the **Unit**(Time unit) of Parameter 2.

Time chart

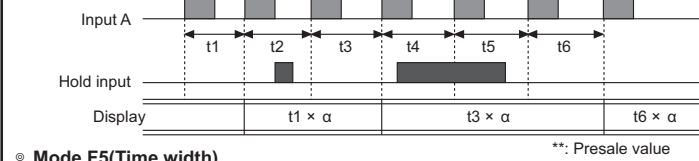

Mode F5(Time width)

It displays the ON time of input A.
Time width(T) = t
※t : ON measurement time of input A[sec]

Display value and display unit

Display value	Display unit	MIN
Time width	SEC	999.99min.
	999.99sec.	9999.9min.
	99hour 59.9sec.	99hour 59.9min.
	9hour 59min. 59sec.	999hour 59min. 59sec.
	99999sec.	99999min.

※Set the display unit at the **Unit**(Time unit) of parameter 2.
※Display unit of factory default : 999.99sec.

Time chart

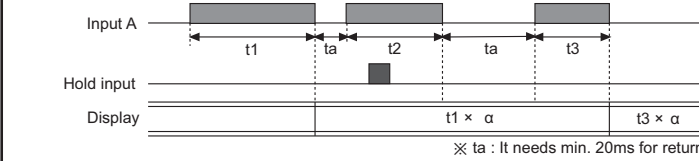

Mode F6(Time interval)

It displays the time from input A is ON to input B is ON.
Time difference(T) = t(ta to tb)
※t(ta to tb):The measurement time from input A is ON to input B is ON[sec]

Display value and display unit

Display value	Display unit	MIN
Time interval	SEC	999.99min.
	999.99sec.	9999.9min.
	99hour 59.9sec.	99hour 59.9min.
	9hour 59min. 59sec.	999hour 59min. 59sec.
	99999sec.	99999min.

※Display unit of factory default : 999.99sec.
※Display unit can be set at **Unit**(Time unit) of Parameter 2.

Time chart

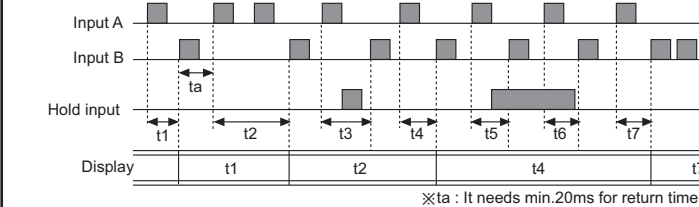

Mode F7(Absolute rate)

It displays how many percentage(%) faster or late, speed, volume etc. of Input B against input A)
Absolute rate = $(\text{Input B} / \text{Input A}) \times 100\%$

$$\text{Absolute rate} = \frac{\text{Frequency of input B[Hz]} \times \text{Ba}}{\text{Frequency of input A[Hz]} \times \text{Aa}} \times 100\%$$

Display value and display unit

Display value	Display unit
Absolute rate	%

※Aa : Prescale value of input A
Ba : Prescale value of input B

Time chart

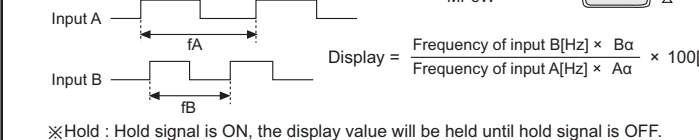

※Hold : Hold signal is ON, the display value will be held until hold signal is OFF.

Mode F8(Error ratio)

It displays how many percentage(%) faster or late of Input B against Input A.

$$\text{Absolute rate} = \frac{\text{Input B} - \text{Input A}}{\text{Input A}} \times 100\%$$

$$\text{Error rate} = \frac{(\text{Frequency of input B[Hz]} \times \text{Ba}) - (\text{Frequency of input A[Hz]} \times \text{Aa})}{\text{Frequency of input A[Hz]} \times \text{Aa}} \times 100\%$$

Display value and display unit

Display value	Display unit
Error rate	%

※Aa : Prescale value of input A
Ba : Prescale value of input B

Time chart

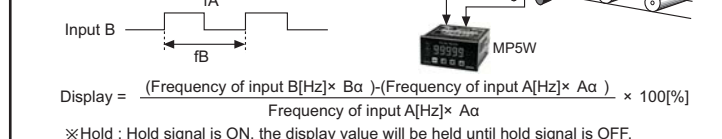

$$\text{Display} = \frac{(\text{Frequency of input B[Hz]} \times \text{Ba}) - (\text{Frequency of input A[Hz]} \times \text{Aa})}{\text{Frequency of input A[Hz]} \times \text{Aa}} \times 100\%$$

※Hold : Hold signal is ON, the display value will be held until hold signal is OFF.

Mode F9(Density)

It displays the density rate of input B against total sum of input A and input B.

$$\text{Density} = \frac{\text{Input B}}{\text{Input A} + \text{Input B}} \times 100\%$$

Display value and display unit

Display value	Display unit
Density	%

※Aa : Prescale value of input A
Ba : Prescale value of input B

Time chart

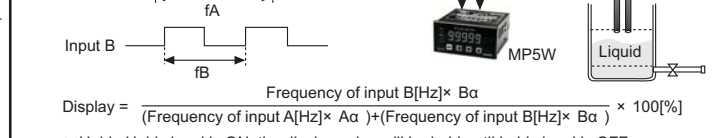

$$\text{Display} = \frac{\text{Frequency of input B[Hz]} \times \text{Ba}}{(\text{Frequency of input A[Hz]} \times \text{Aa}) + (\text{Frequency of input B[Hz]} \times \text{Ba})} \times 100\%$$

※Hold : Hold signal is ON, the display value will be held until hold signal is OFF.

Mode F10(Error)

It displays the error between standard Input A and comparing Input B.
Error = Input B - Input A
Error = $(\text{Frequency of input B[Hz]} \times \text{Ba}) - (\text{Frequency of input A[Hz]} \times \text{Aa})$

Display value and display unit

Display value	Display unit
Error	END User setting unit

※Aa : Prescale of input A
Ba : Prescale of input B

Time chart

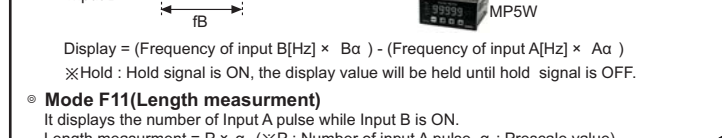

$$\text{Display} = (\text{Frequency of input B[Hz]} \times \text{Ba}) - (\text{Frequency of input A[Hz]} \times \text{Aa})$$

※Hold : Hold signal is ON, the display value will be held until hold signal is OFF.

Mode F11(Length measurement)

It displays the number of Input A pulse while Input B is ON.
Length measurement = $P \times \alpha$ (※P : Number of input A pulse, α : Prescale value)

Display value and display unit

Display value	Display unit
Length measurement	Quantity[EA]

※Factory default(Unit) : Quantity[EA]

Time chart

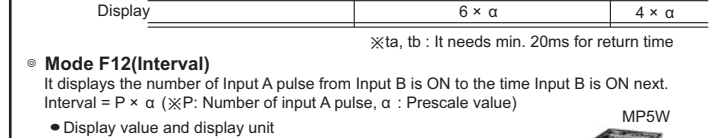

$$\text{Display} = (\text{Frequency of input B[Hz]} \times \text{Ba}) - (\text{Frequency of input A[Hz]} \times \text{Aa})$$

※ta, tb : It needs min. 20ms for return time

Mode F12(Interval)

It displays the number of Input A pulse from Input B is ON to the time Input B is ON next.
Interval = $P \times \alpha$ (※P : Number of input A pulse, α : Prescale value)

Display value and display unit

Display value	Display unit
Interval	Quantity[EA]

※Factory default(Unit) : Quantity[EA]

Time chart



※ta : It needs min. 20ms for return time. P-2

Mode F13(Integration)

It displays the counting value against pulses of Input A.
Integration = P × α
※P: Pulse number of input A, α: Prescale value

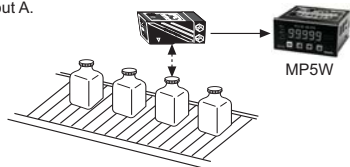

Display value and display unit

Display value	Display unit
Integration	Quantity[EA]

Operation and Time chart

- ① It counts the number of input A pulse.
- ② As input B is an enable input signal it stops the counting and display value of input A when it is ON and then it counts input A continuously when it is OFF.

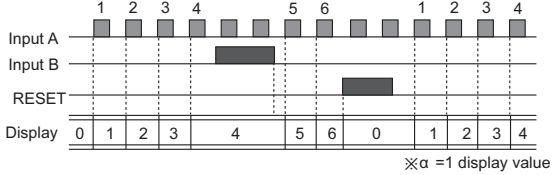

Output mode

- Select output mode in **out-t** (output type) of Parameter 1 group.
- There are 5 stages output (HH, H, GO, L, LL) and 3 stage output (H, GO, L).
- There are 6 kinds of output mode such as S(Standard) output mode, H(High) output mode, L(Low) output mode, B(Block) output mode, I(One shot) output mode, F(Deviation) output mode.
- Comparative value(HH, H, L, LL) can be set as LL<L<H<HH in B output mode and the other outputs can be operated separately in output (S, H, L, I) mode regardless of comparative(HH, H, L, LL) set value.

S(Standard) output mode[5t-R-d]

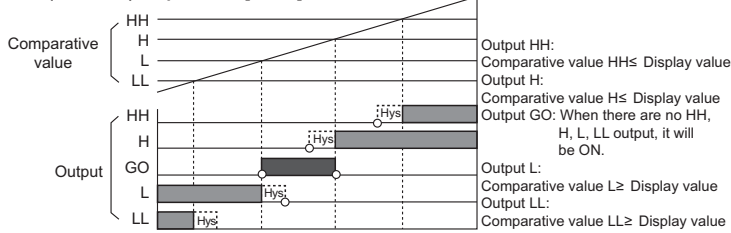

H(High) output mode[out-h]

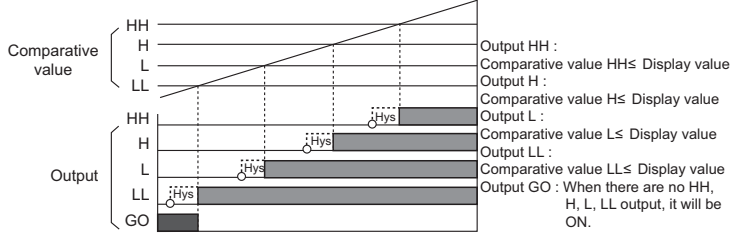

L(Low) output mode[out-L]

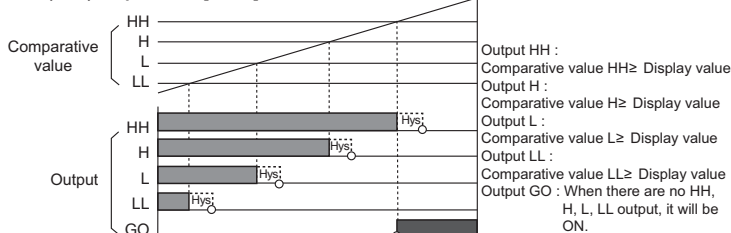

B(Block) output mode[out-b]

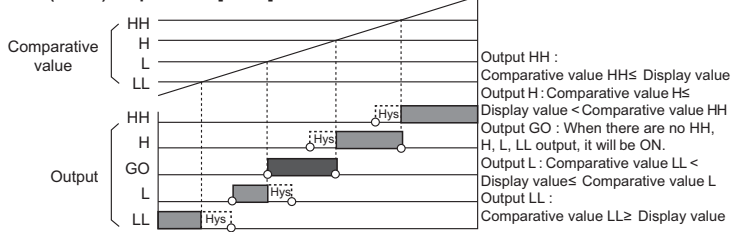

I(One Shot) output mode[out-I]

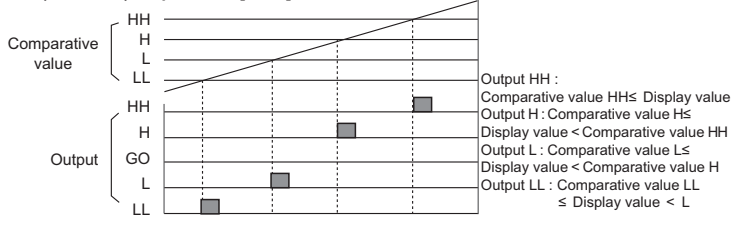

- ※There is no GO output in output I mode.
- ※One Shot (I) output time has been fixed 0.3sec.
- ※There is no Hysteresis in I(One shot) comparative output mode.

F(Deflection) output mode[out-F]

This function is to memorize the setting value and provide outputs when it exceeds the deviation of H, L.

- The setting value memory: Memorize the current display value as the setting value by pressing [MD]+[▲] key in front.
- Display the setting value: Check the memorized setting value by [▲] key. (Display the memorized setting value for pressing [▲] key continuously.)
- Deviation setting: Set H, L deviation by setting value. (The set deviation will be memorized until set the next deviation again when power off.)
- Setting range: 0.0001 to 99999 (The setting range will be changed by decimal point setting parameter. If set decimal point as 0000.0, the setting range will be 0.1 to 9999.9.)
- Operation

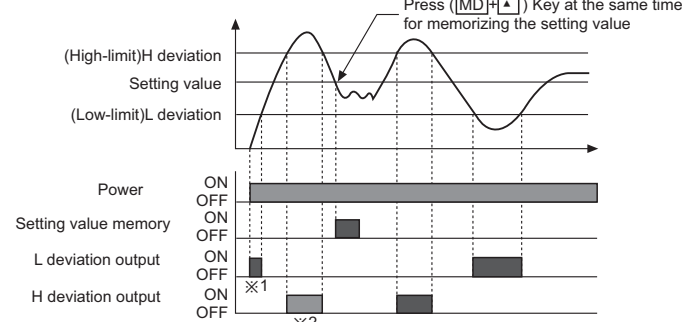

- ※1: When select the comparative output limit function, output will not come.
- ※2: Output position may different from above graph as output coming under assuming the setting value memory is before the setting value memory point on above graph.
- ※There are no HH, GO, LL outputs in F output mode.
- ※Even though you set the deviation as "0(Zero)", it will actually work as setting "1".

Operation chart by each Parameter group

- The display parameter are different by each operation mode, please see "Parameter".
- : When select the operation mode, the parameter will be displayed.
- ×: When select the operation mode, the parameter will not be displayed.

Parameter 0 group

Parameter 0	Sub mode	F1	F2	F3	F4	F5	F6	F7	F8	F9	F10	F11	F12	F13
PSt.hh		●	●	●	●	●	●	●	●	●	●	●	●	●
PSt.h		●	●	●	●	●	●	●	●	●	●	●	●	●
PSt.L		●	●	●	●	●	●	●	●	●	●	●	●	●
PSt.LL		●	●	●	●	●	●	●	●	●	●	●	●	●
h.PEY		●	●	●	●	●	●	●	●	●	●	●	●	×
L.PEY		●	●	●	●	●	●	●	●	●	●	●	●	×

Parameter 1 group

Parameter 1	Sub mode	F1	F2	F3	F4	F5	F6	F7	F8	F9	F10	F11	F12	F13
nodE		●	●	●	●	●	●	●	●	●	●	●	●	●
in-A		●	●	●	●	●	●	●	●	●	●	●	●	●
in-b		×	●	×	×	×	×	●	●	●	●	●	●	●
out-t		●	●	●	●	●	●	●	●	●	●	●	●	×
hys		●	×	×	×	×	×	●	●	●	●	×	×	×
GuAr.d	F.dEFY	●	●	●	●	●	●	●	●	●	●	●	●	×
	StAr.t	●	●	●	●	●	●	●	●	●	●	●	●	×
Aut.oA		●	×	×	×	×	×	●	●	●	●	×	×	×
Aut.oB		×	×	×	×	×	×	●	●	●	●	×	×	×
nE.nO		×	×	×	×	×	×	×	×	×	×	×	×	●

※"×": in-b sensor will be set as nPn.h.F or PnPh.F in mode F11, F12, F13.

Parameter 2 group

Parameter 2	Sub mode	F1	F2	F3	F4	F5	F6	F7	F8	F9	F10	F11	F12	F13
PbAn.t		●	●	●	●	●	●	●	●	●	●	●	●	●
dat		●	●	×	×	×	×	●	●	●	●	●	●	●
Aut.t		×	×	●	●	●	●	×	×	×	×	×	×	×
PSt.hh		●	●	●	●	●	●	●	●	●	●	●	●	●
PSt.h		●	●	●	●	●	●	●	●	●	●	●	●	●
PSt.L		●	●	●	●	●	●	●	●	●	●	●	●	●
PSt.LL		●	●	●	●	●	●	●	●	●	●	●	●	●
PSt.RH		●	×	×	×	×	×	●	●	●	●	●	●	●
PSt.RY		●	×	×	×	×	×	●	●	●	●	●	●	●
PSt.bH		×	×	×	×	×	×	●	●	●	●	×	×	×
PSt.bY		×	×	×	×	×	×	●	●	●	●	×	×	×
dI.SP.t		●	×	×	×	×	×	×	×	×	×	×	×	×

※1: PSt.H, PSt.Y are displayed in mode F1, F2, F4, F11, F12, F13.

Parameter 3 group

Parameter 3	Sub mode	F1	F2	F3	F4	F5	F6	F7	F8	F9	F10	F11	F12	F13	
F5-h		※When it is PV transmission output, it operates in all mode.													
F5-L		※When it is PV transmission output, it operates in all mode.													
Ad.dr		※When it is RS485 communication output, it operates in all modes.													
bP5		●	●	●	●	●	●	●	●	●	●	●	●	●	
rE.nO.t		●	●	●	●	●	●	●	●	●	●	●	●	●	
LoC		●	●	●	●	●	●	●	●	●	●	●	●	●	

Monitoring delay function operation chart by each output mode

out-t	StAr.d	out-h	out-L	out-b	out-I	out-F
Comparative output adjustment function.	●	×	×	●	×	●
Starting correction timer function	●	●	●	●	●	●

Parameter

Parameter 0 group

Menu and Parameter display	Parameter	Setting range	Setting key
	Set HH comparative value	● F1, F2, F7, F9, F11, F12, F13 : 0 to 99999	◀ : Move the setting digit ◻, ▲ : Change the setting value MD : Fix and move to the next parameter
	Set H comparative value		
	Set L comparative value	● F3 to F6 : 0 to Setting time range	
	Set LL comparative value	● F8, F10 : -19999 to 99999	
	Display high peak value among measuring values		● Reset If you press ◻ key for 2sec. while h.PEY or L.PEY is flickering, the Peak value display will be reset to the current measuring value and it will keep flickering. MD If you touch once again, it will return to L.PEY or RUN.
	Display low peak value among measuring values		

- ※1: If you press MD key in RUN mode, it will enter into PSt.hh(F output mode:PSt.h) at comparative output mode and h.PEY at indication type.
- ※When entering into parameter 0, the parameter and data will be flickering by 1 sec. then moving the setting digit and changing the setting value are available.
- ※It will show the set data to flicker by 1sec., then move to next Parameter with touching MD key once.

Parameter 1 group

Menu and Parameter display	Parameter	Setting range	Setting key
	This is parameter 1 group.		
Select operation mode.	F1 to F13	◻, ▲ : Change the setting mode → F1 → F2 to F13 MD : Fix and move to the next parameter	
Set the sensor type of input A.	● PNP transistor output type : PnPh.F ● Contact output type(L output) : PnP.L.F ● NPN transistor output type : nPn.h.F ● Contact output type(H output) : nPn.L.F	◻, ▲ : Change the sensor type MD : Fix and move to the next parameter	
Set the sensor type of input B.			
Select the output mode. ※1	StAr.d / out-h / out-L / out-b / out-I / out-F	◻, ▲ : Change the setting mode → StAr.d → out-h → out-L out-F ← out-I ← out-b MD : Fix and move to the next parameter	
Set the hysteresis for the output. ※2	0 to 9999 (If decimal point is set in 0000.0, the range will be 0 to 9999.)	◻ : Move the setting digit ◻, ▲ : Change the setting value MD : Fix and move to the next parameter	
Select the start compensating timer function or comparative output(L, LL) limit function. ※3	① F.dEFY / StAr.t ② When select StAr.t 999 by 1sec. cycle, set the starting correction time 0.0 to 99.9	① ◻, ▲ : Change the setting mode → F.dEFY → StAr.t MD : Fix and move to the next parameter ② ◻ : Move the setting digit ◻, ▲ : Change the setting value MD : Fix and move to the next parameter	
Set the Auto-zero time of INA input.	0.1 to 9999.9	◻ : Move the setting digit ◻, ▲ : Change the setting value MD : Fix and move to the next parameter	
Set the Auto-zero of INB input.	0.1 to 9999.9	◻ : Move the setting digit ◻, ▲ : Change the setting value MD : Fix and move to the next parameter	
It sets the memory retention. The measuring value will be memorized when the power off. (Mode F13 only)	on : Memory retention off : No memory retention	◻, ▲ : Change the setting mode → on → off MD : Fix and move to the next parameter nodE.	

- ※If press MD key for 3 sec. in RUN, it will enter into parameter 1 group.
- ※1: It will not be displayed in indication type.
- The output mode is fixed as out-h type in F13 operation mode.
- ※2: Hysteresis operation mode is able to be set in F1, F7 to F10 operation mode.
- ※3: You are able to select the comparative output[F.dEFY] limit function or starting correction[StAr.t] timer in monitoring delay function mode.
- When selecting the comparative output limit[F.dEFY] function, it will move to the next parameter[Auto.A] and when selecting the starting correction timer[StAr.t] you need to be set the starting correction time[0.0 ~ 99.9] so that it moves to the next parameter[Auto.A].
- ※If press MD key for over 2 sec. in every setting mode, data will be set and return to RUN.
- ※When entering into parameter 1 group, the parameter name and data will be flickering by 1 sec. then move setting digit by ◻ key or change the setting value by ◻, ▲ key.
- ※All data set by users will be shown[displayed] to 1sec. cycle then move to the next parameter by pressing MD key.

