

LGM Series

Measuring Automation Light Grid

Brief Instructions

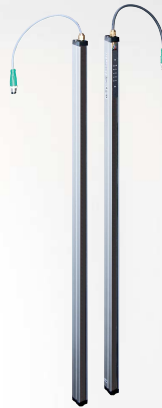

IO-Link



Your automation, our passion.

 **PEPPERL+FUCHS**

With regard to the supply of products, the current issue of the following document is applicable: The General Terms of Delivery for Products and Services of the Electrical Industry, published by the Central Association of the Electrical Industry (Zentralverband Elektrotechnik und Elektroindustrie (ZVEI) e.V.) in its most recent version as well as the supplementary clause: "Expanded reservation of proprietorship"

Worldwide

Pepperl+Fuchs Group

Lilienthalstr. 200

68307 Mannheim

Germany

Phone: +49 621 776 - 0

North American Headquarters

Pepperl+Fuchs Inc.

1600 Enterprise Parkway

Twinsburg, Ohio 44087

USA

Phone: +1 330 425-3555

Asia Headquarters

Pepperl+Fuchs Pte. Ltd.

P+F Building

18 Ayer Rajah Crescent

Singapore 139942

Phone: +65 6779-9091

ООО "РусАвтоматизация"

454010 г. Челябинск, ул. Гагарина 5, оф. 507

тел. 8-800-775-09-57 (звонок бесплатный), +7(351)799-54-26, тел./факс +7(351)211-64-57

info@rusautomation.ru; русавтоматизация.рф; www.rusautomation.ru

- 1 Introduction 4**
 - 1.1 Purpose of These Brief Instructions 4**
 - 1.2 Product documentation on the internet 4**
 - 1.3 Intended Use 4**

- 2 Product Description 6**
 - 2.1 Indicators and Control elements 6**
 - 2.2 Interfaces and Connections 8**
 - 2.3 Scope of Delivery 9**

- 3 Installation 10**
 - 3.1 Mounting 10**
 - 3.2 Connecting the Sensor Units 12**

- 4 Commissioning the Light Grid 16**

- 5 Operation 17**
 - 5.1 Operating the Light Grid Using the Programming Interface 17**
 - 5.2 Commissioning and Operating the Light Grid with IO-Link 22**
 - 5.2.1 Process Data 23**
 - 5.2.2 Programmable Functions of the Light Grid 24**

- 6 Appendix 28**
 - 6.1 Technical Data 28**

1 Introduction

1.1 Purpose of These Brief Instructions

These brief instructions contains basic instructions for operating the device. However, the manual takes priority over the brief instructions.

1.2 Product documentation on the internet

You can view all the relevant documentation and additional information on your product at <http://www.pepperl-fuchs.com>. Simply enter the product name or model number in the **Product/Key word search** box and click **Search**.

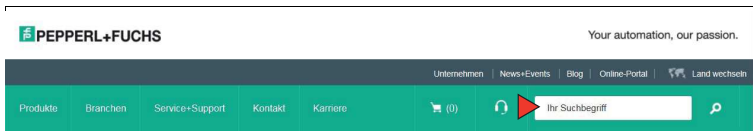

Select your product from the list of search results. Click on the information you require in the product information list, e.g., **Technical documents**.



A list of all available documents is displayed.

1.3 Intended Use

The measuring LGM light grid consists of an emitter and receiver strip. Located between the strips is the measuring range consisting of infrared light beams. When an object enters the measurement field, one of several selectable measuring methods sends out data on the interrupted beams via I/O-Link. The reading is in mm.

Application areas

- Warehousing and material handling, packaging industry



Caution!

Not a safety component

The light grid is not a certified safety light grid in accordance with EN 61496. It is also not a safety component under the terms of the EU Machinery Directive 2006/42/EC. The light grid must therefore not be used for the purpose of preventing risk to individuals or parts of the body.

Always operate the device as described in these instructions to ensure that the device and connected systems function correctly. The protection of operating personnel and plant is guaranteed only if the device is operated in accordance with its intended use.

The device and its input and output circuits must be operated from a power supply that fulfills the requirements of PELV/SELV systems.

Only use recommended original accessories.

The operating company bears responsibility for observing locally applicable safety regulations.

Installation and commissioning of all devices may be performed only by trained and qualified personnel.

It is dangerous for the user to make changes and/or repairs. Additionally, doing so voids the warranty and excludes the manufacturer from any liability. In the event of any serious errors, stop using the device. Secure the device against unintended operation. To have the device repaired, return it to your local Pepperl+Fuchs representative or your sales center.



Note

Repairs

If the light grid requires repair, please send the emitter **and** receiver together to Pepperl+Fuchs.

2 Product Description

2.1 Indicators and Control elements

Emitter unit

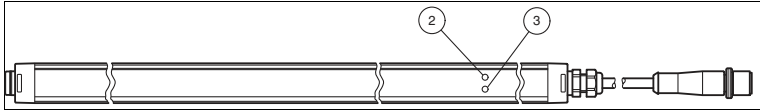

Figure 2.1 Function indicator on the emitter unit

- ② Operation indicator: indicates power-on or power-save mode
- ③ Status indicator: indicates transmission power, fault state, or active test mode

Operation indicator and status indicator on the emitter

Function	Diagnostic description
Operation indicator (green LED)	
Green LED on	Power-on
Green LED off Yellow LED flashing	Power-save mode
Status indicator (yellow LED)	
Yellow LED off	Power of emitter is low
Yellow LED is on	Power of emitter is high
Yellow LED flashing	Fault state
Yellow LED changes state	Test mode is active

Receiver unit

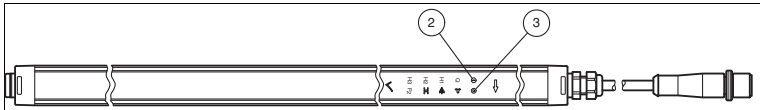

Figure 2.2 Function indicator on the receiver unit

- ② Operation indicator: indicates power-on, power-save mode, IO-Link mode active, or fault state
- ③ Status indicator: indicates detection field status, functional reserve, or fault state

Operation indicator and status indicator on the receiver

Function	Diagnostic Description
Operation indicator (green LED)	
Green LED permanently on	Power-on
Green LED permanently off	Power-save mode
Green LED flashes with short interruption	Active IO-Link mode, receiver's operating panel locked
Green LED flashes with 4 Hz	Fault status: short circuit at the outputs
Status indicator (yellow LED)	
Yellow LED permanently on	Detection field interrupted
Yellow LED permanently off	Detection field vacant
Yellow LED flashes (approx. 4 Hz)	Insufficient functional reserve
Yellow LED flashes (approx. 8 Hz)	Fault state: fault during signal measurement

The control panel on the receiver unit consists of 12 indicator elements. The two outer two symbols act as control elements (touch buttons). The receiver unit can be parametrized via menu selection on the control panel (see chapter 5.1).

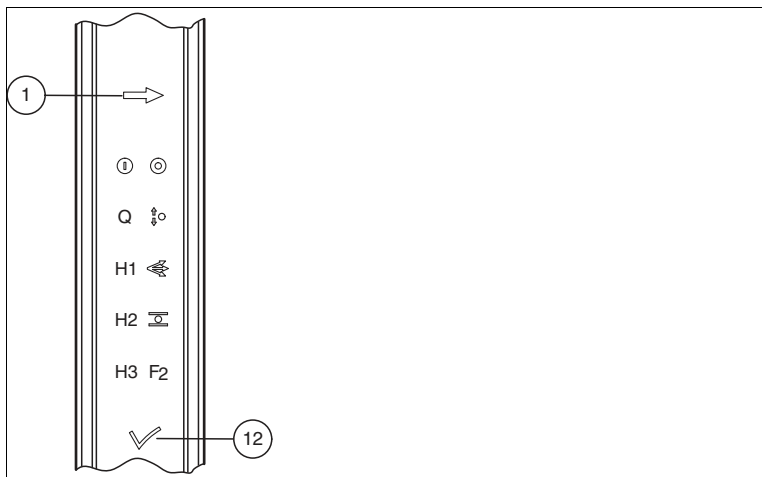



Figure 2.3 Controls on the Receiver unit

Control elements

Number	Symbol	Parameter	Description
1		Menu button	Function selection
12		OK button	Function confirmation

For a detailed description of the function status indicators, please see see chapter 5.1.

2.2 Interfaces and Connections

Use two M12 plugs for the electrical connection. The emitter unit has a cable with a 4-pin plug and the receiver unit a cable with an 8-pin plug.

Emitter unit

Figure 2.4 Emitter unit connection layout

- 1 24 V DC
- 2 Range (In)
- 3 0 V DC
- 4 Test (In)

Receiver unit

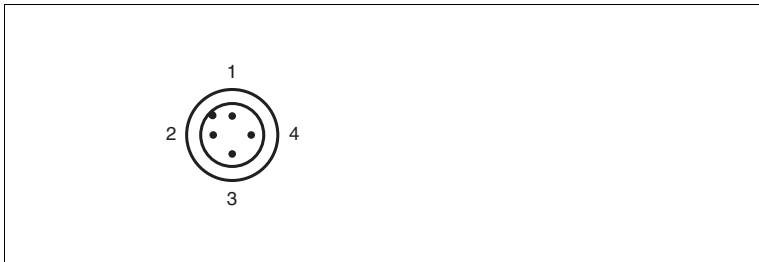
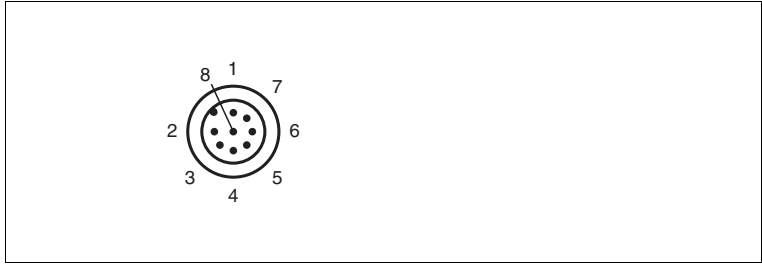

Figure 2.5 Receiver unit connection layout

- 1 + UB
- 2 SC (Stability Control, Out)
- 3 0 V DC
- 4 C/Q (IO-Link / Out)
- 5 Q (Out)
- 6 not connected
- 7 not connected
- 8 Teach-In (In)

IO-Link communication is established via the C/Q (Pin 4) connection.

2.3 Scope of Delivery

The scope of delivery includes:

- Emitter unit and receiver unit
- Quick start guide
- Cable lug and housing screw as spare part

Brackets and cables are not included in the scope of delivery. See the appendix or visit <http://www.pepperl-fuchs.com> for a selection of compatible mounting brackets and recommended cables.

3 Installation

3.1 Mounting

Make sure the detection field is free from obstacles. The first and last beams within the detection field are used for optical synchronization of emitter and receiver units. If both beams are blocked, synchronization is lost and the measurement is inhibited. The system is preconfigured for operation with cable outlet upwards. For installation with cable outlet downwards, the receiver unit can be configured via IO-Link for the zero-point reference on the cable side.

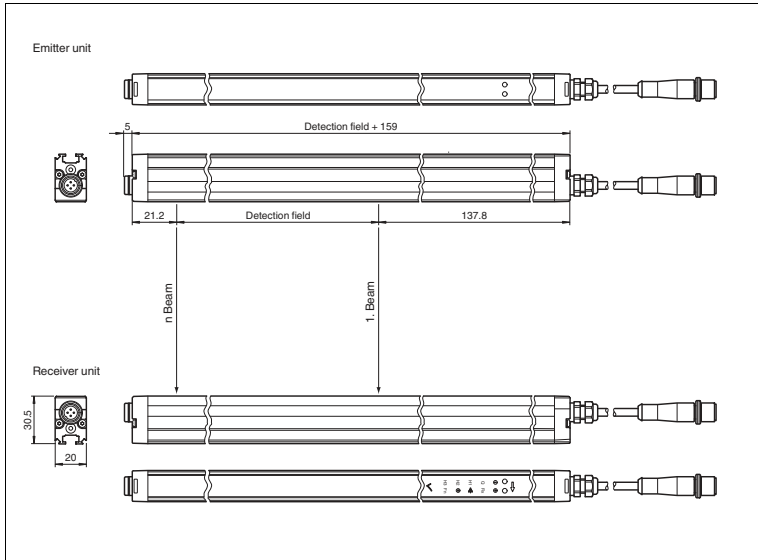

Figure 3.1 Light Grid Dimension Drawing

To mount the slim panels, use customized bore holes ($d = 4.5$ mm for M4 screws) or a rear, continuous groove (for flat M6 nuts in accordance with ISO 4035).

Various brackets are available for mounting the light grid .

Mounting Using the Rear Groove

There is a continuous groove located on the rear of the strip on the light grid. Standard flat M6 nuts (in accordance with DIN 4035) fit into this groove. You can mount the light grid using these inserted nuts.

Mounting Using Customized Bore Holes

You can mount the light grid using user-defined holes. The maximum screw size is M4. Make sure to follow the instructions when positioning the hole. Improper handling can damage internal electronics.



Preparation

1. Mark the position of the holes. Focus on the lateral continuous line on the light grid.
2. Mark the position of the holes.
3. Using a 4.5 diameter drill, drill right through the housing.
4. Deburr the hole.
5. Repeat the first steps to drill all the holes.
6. Make sure that the aluminum chippings do not scratch the optical surface.

↳ Secure the light grid in its final position with the holes you made.

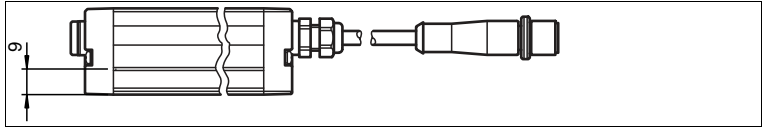

Figure 3.2 Position the center point of the installation holes.

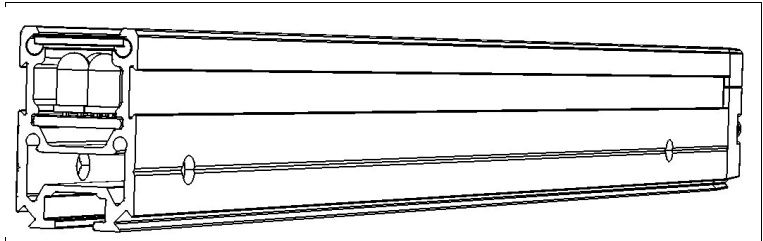

Figure 3.3 Installation holes



Installation

1. Align the emitter and receiver units so they are parallel to one another and at the same height.
2. The units must be aligned with an accuracy of approximately $\pm 5^\circ$.
3. During installation, ensure that the two units are the same way up. (Both units with the cable outlet either up or down).
4. Do not exceed the maximum range.

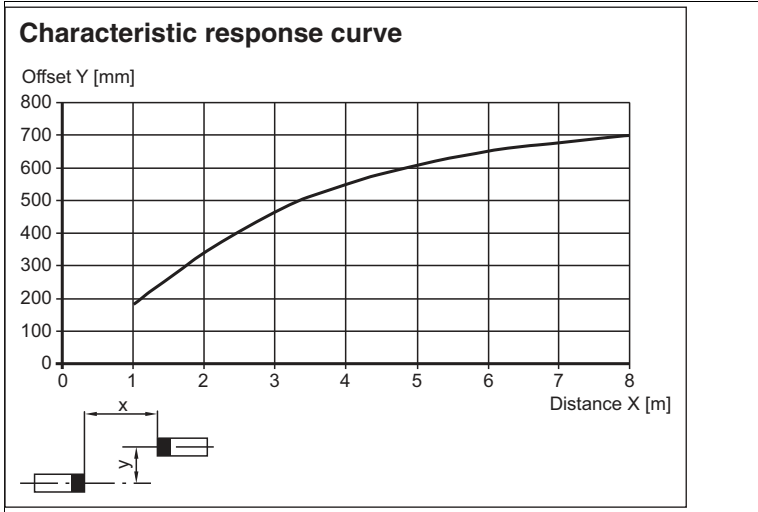

Figure 3.4 Maximum offset between emitter and receiver

3.2 Connecting the Sensor Units



Caution!

Electrical connection

Wiring work that requires the opening and closing of electrical connections must always be performed with the power disconnected.

Use a Class 2 power supply to supply the power (certified according to UL 1310).

Connecting the Emitter unit

Connect the emitter unit as described in the section Interfaces and Connections (see chapter 2.2). Insulate unused wires. See circuit example on the following page.

Connection	Description	
Range input Pin 2	The emitter power can be adjusted for specific sensing ranges according to application requirements. Reducing emitter power is useful for avoiding optical interference with other sensors.	
	Input open	Max. 1.6 m
	+U _B	Max. 6 m
	0 V	Max. 6 m

Connection	Description	
Test input Pin 4	The emitter unit features a test input with two functionalities: <ul style="list-style-type: none"> • test mode • power safe mode These functionalities can be activated by connection of the test input to either $+U_B$ or 0 V. The functions are inactive if the test pin is left open (high impedance).	
	Test mode:	Activate the test input for max. 1.2 seconds. The emitter beams are turned off. The receiver unit will detect this the same way as a beam interruption by an object.
	Power save mode:	Test input is active for more than 1.2 seconds: The emitter unit enters the power save mode. The receiver unit will change to power save mode if optically synchronized with the emitter. The measurement is inhibited in this mode and power consumption is reduced to minimum. Test input set to inactive: Emitter and receiver units resume to normal operation. Note: The receiver unit as well resumes to normal operation if the optical synchronization is lost.

Connecting the Receiver unit

Connect the receiver unit as described in the section Interfaces and Connections (see chapter 2.2). All outputs are short-circuit proof. Insulate unused wires. See circuit example shown below.

Connection	Description
Stability control (SC) output Pin 2	The SC output gets active with a delay of 5 seconds, if the receiver unit detects signals below stability control threshold (functional reserve). The status indicator flashes at 4 Hz. The SC output returns immediately to normal operation (inactive state) with receiver signals above the stability control threshold.
Switching output (C/Q) Pin 4	This connection has 2 functions. (By default, the switching output is active once the device is powered on; SIO mode) Switching output: This signal output is active (active with dark ON, inactive with light ON) if an object is detected or identified according to parameter settings. This means that the output is always active when status indicator 4 (Q) is on. IO-Link interface: When the light grid is running in IO-Link mode, it communicates with the master via this connection.
Remote control (Teach-in input) Pin 8	The receiver unit features a Teach-in input. This input can be used to remotely stimulate the functions of the two control buttons: <ul style="list-style-type: none"> • Menu button (input connected to +U_B) • OK button (input connected to 0 V) (see circuit example below) Note: The Teach-in input functionality can be inhibited by connecting this terminal permanently to +U _B .

Circuit Example

The LEDs on the outputs are optional.

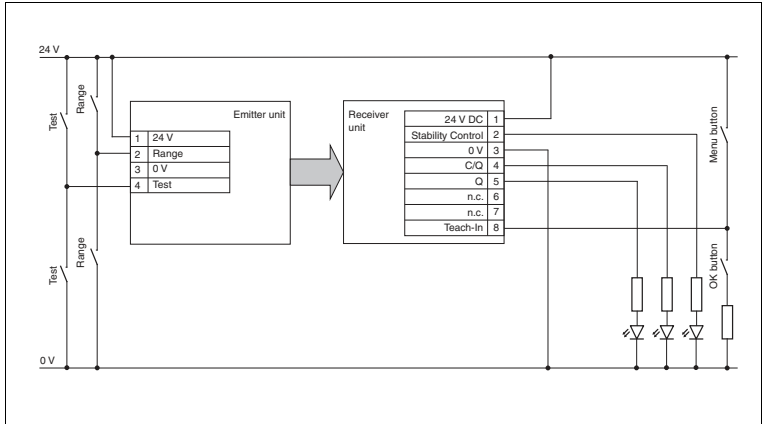

Figure 3.5 Circuit example LGM

4 Commissioning the Light Grid



1. Check that the power supply and signal lines to the light grid are connected correctly. When using an IO-Link Master, make sure that the C/Q communication line is connected to the corresponding port on the IO-Link master.
2. Check that the light grid is in the correct position and orientation.
3. Turn on the power supply. The green operation indicators on emitter and receiver units are on.
4. If the emitter and receiver units are aligned, the status indicator is off. The status indicator lights up when the device is misaligned or an object is detected.

↳ The two units are perfectly aligned and can now be configured .

For commissioning and operation of the light grid in IO-Link mode, please refer see chapter 5.2.

5 Operation

5.1 Operating the Light Grid Using the Programming Interface

The Receiver Strip Can Be Manually Configured and Parameterized Using the Programming Interface

- Standard operation in accordance with configuration and parameterized values
- Functions of first parameterization level
- Functions of second parameterization level

Displays and Operating Elements

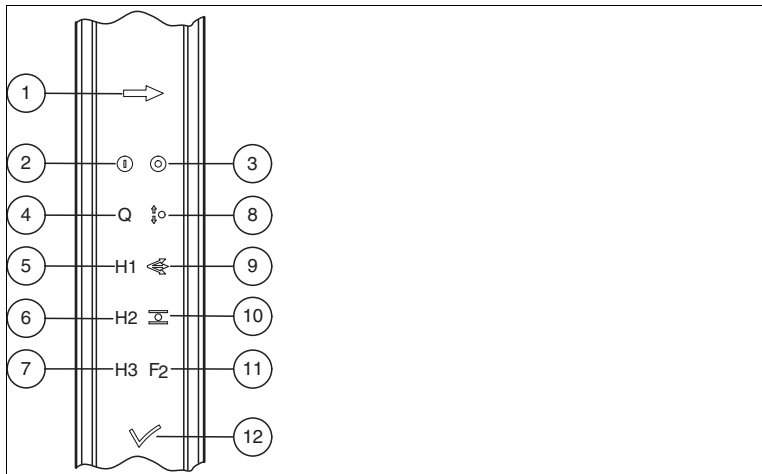

Figure 5.1 Function indicators on the receiver strip

Number	Symbol	Function	Description
1	→	Menu key	Press the Menu key once to switch the device to parameterization mode.
2	⏏	Operating indicator	Indicator for operating state and power save mode
3	⦿	Status indicator	Indicator for detection field status, operating reserve status, and fault status
4	Q	Q display	Display for object identification status and, in general, for detection field status













Number	Symbol	Function	Description
		OK key	Press OK once to display the parameterization status. (First-level functions)
The other indicators have no function in standard operation			

Table 5.1 Display and function in standard operation

When you select a function, the current status of this function is displayed within parameterization mode. The indicator flashes at approx. 1 Hz according to the following pattern:

Display mode	Display pattern
Active	Long on, short off
Inactive	Long off, short on

The following table shows the indicators and functions of the programming interface in parameterization mode.

Number	Symbol	Parameter	Display mode	Description
		Menu key		Repeatedly press the Menu key to select the required parameterization function
		OK key		Press OK to modify a value or to initiate the selected function
		Q display		Object identification function selected
		Inactive	Inactive	Reset parameters for object identification
		Active	Active	Teach-in parameters for object identification
		Object identification type		Object identification type function selected
		Stationary	Inactive	Identification of stationary objects selected
		Moving	Active	Identification of moving objects selected
		Beam mode		Beam mode function selected
		Single-beam scanning	Inactive	Simple resolution Corresponds to the beam spacing
		Three-way beam crossover	Active	Double resolution

25.1720 2021-03

Number	Sym- bol	Parameter	Display mode	Description
10		Tolerance field		Tolerance field function selected (applies to object field, gaps, and suppression area)
		Off	Inactive	No tolerance applied
		Simple resolution	Active	Tolerance corresponds to resolution set
11	F2	2. Level (Skip/Select)		Second-level functions selected In the second level, the F2 indicator lights up in combination with the selected function
11 4	F2Q	Suppression area		Suppression areas function selected
		Inactive	Inactive	Suppression areas are deactivated
		Active	Active	Suppression area corresponds to taught-in values
11 5	F2H1	Object identifica- tion mode		Object identification function selected
		Object detection	Inactive	Object identification in accordance with taught-in parameters
		Gap detection	Active	Gap detection in accordance with taught-in parameters
11 6	F2H2	Switching signal polarity		Switching signal polarity function selected
		Not inverted – dark- on	Inactive	Output Q is activated if an object/gap is detected
		Inverted – light-on	Active	Output Q is activated if no object/gap is detected
11 7	F2H3	Default settings		Default settings function selected
		Skip	Inactive	The function is not executed
		Restore	Active	The default settings are restored

Number	Symbol	Parameter	Display mode	Description
<p>(11)</p> <p>(8)</p>		Signal tracking		<p>Signal tracking function selected. In non-stable ambient conditions, e.g., soiling and temperature changes, signal tracking ensures that the response threshold remains constant. Reflective objects that are occasionally present along the detection field can distort signal tracking and cause switching faults. In the worst-case scenario, permanent detection is signaled even though there is no object in the monitoring field. In this case, the function must be disabled. Signal tracking is inactive in the factory setting.</p> <p>Parameterization via IO-Link: Parameterization via IO-Link allows the response threshold and signal tracking to be defined independently of each other.</p> <p>=> Without tracking: The response threshold can be selected in 10 % increments between 0 = minimum threshold, 1 = 10 %, and 9 = 90 %.</p> <ul style="list-style-type: none"> 0 = minimum threshold, no tracking, maximum gain, default value 1 = 10 % of value of response threshold, no tracking 2 = 20 % of value of response threshold, no tracking 9 = 90 % of value of response threshold, no tracking <p>=> With tracking: The response threshold value for response threshold that can be freely selected, with tracking can be freely selected between 10 % ... 90 %. This allows customized configuration between fine resolution (high threshold) and high immunity to reflective objects (low threshold).</p> <ul style="list-style-type: none"> 10 % ... 90 % = value for response threshold that can be freely selected, with tracking
		Inactive	Inactive	Pressing the OK button again disables signal tracking. When signal tracking is disabled, the lowest switching threshold is configured. The optical resolution is increased by ≤ 4 mm.
		Active	Active	Pressing the OK button enables signal tracking. When signal tracking is enabled, the specified resolution is reached. The value of the switching threshold is set to ≥ 60 %.

Number	Sym- bol	Parameter	Display mode	Description
--------	-------------	-----------	-----------------	-------------

Table 5.2 Parameterization and displays for first-level and second-level functions

Operating Sequence

Press the  menu key to activate parameterization. The Q object symbol flashes to signal active parameterization.

Press the  menu key repeatedly to select the required function according to the previous table. The corresponding indicator begins to flash.



Press the OK key  to switch between permitted values or to start the selected function, e.g., to teach in parameters or to reset to default settings.

Before object or suppression area teach-in, the corresponding object must be located in the detection field. Without locating an object, the parameters of the selected function are reset. On selecting the object identification function, the device switches to LGM mode (light grid mode) see chapter 5.2.2.

If the subsequent function is selected or parameterization mode is exited, the parameters and values are saved permanently.

If the  menu key is pressed with ^{F2} display selected, parameterization mode is exited. The indicator stops flashing. If no operating buttons are pressed within a period of 30 seconds, parameterization automatically ends. Modified parameters are retained.

The current parameterized status can be displayed by briefly pressing the OK key . The activated functions of the first parameterization level are displayed for five seconds.





-  Symbol dimly lit: function is not configured or has been disabled
-  Symbol brightly lit: function is parameterized or activated

For information on operating via an external connection, see see chapter 3.2.



Factory Settings

To restore the factory settings, proceed as follows:

1. Press the Menu button  to enter parameterization mode.
2. Press the Menu button  repeatedly until the "F2" icon starts flashing.
3. Press the Menu button . This will take you to the 2nd parameterization level.
4. Press the Menu button  repeatedly until the "H3" icon starts flashing.

↳ If you now press the OK button , the light grid will be restored to its factory settings..

There are no parameterized objects or functions on delivery.

Default settings





Number	Symbol	Parameter	Status
8		Object identification type	Moving
9		Beam mode	Three-way beam crossover
10		Tolerance field	Simple resolution
4	F2Q	Suppression area	Inactive
5	F2H1	Object identification mode	Object detection
6	F2H2	Switching signal polarity	Not inverted (dark-on)
8		Signal tracking	Inactive

Table 5.3 Default settings

5.2 Commissioning and Operating the Light Grid with IO-Link



Commissioning with IO-Link

To activate the sensor via the IO-Link, proceed with the following steps:

1. Set the corresponding port on the IO-Link master to which the sensor is connected to IO-Link status.
2. When communication is successfully established, the green operating indicator flashes with short interruptions every second.

↳ The sensor now transmits process data and can be parametrized or diagnosis can be run.

Use preset parameters to configure, parameterize, and diagnose the sensors. To parameterize the sensors with an engineering tool, use the device description (IODD), which can be loaded into all system environments with IO-Link support. To operate the sensor in an FDT environment, you can also use a DTM.

See the device description and software, e.g., the IODD, DTM, and the FDT master application within the product at www.pepperl-fuchs.com/io-link.

5.2.1 Process Data

The process data is transmitted as a 16-bit word.

The following illustration shows the data structure using bit offsets:

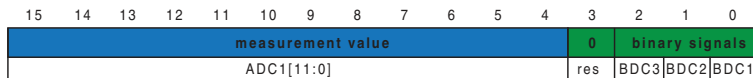

Assignment of process data:

BDC1 - binary data channel 1: switching signal

The switching signal bit indicates if an object is in the beam path, or if an object has been detected	
Data type: bool Bit offset: 0	
BDC1 = 0	No object in the beam path or no object detected
BDC1 = 1	One or more objects in the beam path, or an object has been detected

BDC2 - binary data channel 2: synchronization

The synchronization bit indicates if either of the two synchronization beams was detected by the receiver	
Data type: bool Bit offset: 1	
BDC2 = 0	Light grid not synchronized
BDC2 = 1	Light grid synchronized

BDC3 - binary data channel 3: functional reserve

The functional reserve bit indicates if the light grid is running in the stable operating range, or if it is already in the functional reserve (above or below the functional reserve threshold)	
Data type: bool Bit offset: 2	
BDC3 = 0	Stability control inactive (stable operation range)
BDC3 = 1	Stability control active (signal below functional reserve threshold)

res: reserved

This bit is not used. The value is always "0".
Bit offset: 2

ADC1 - analog data channel 1: measurement value

Output of measurement value (in mm)	
Data type: unsigned integer Length: 12 bits Bit offset: 4	
ADC1 = 0 ... 3200	Measured value depends on the selected measurement value mode (the value range depends on the length of the detection field)
ADC1 = 3201 ... 4094	Not permitted
ADC1 = 4095	Invalid measurement value, no synchronization

5.2.2

Programmable Functions of the Light Grid

Measurement Value Mode

The light grid can be parametrized to different measurement value modes via IO-Link.

The followings diagram shows an overview of all measurement value modes.

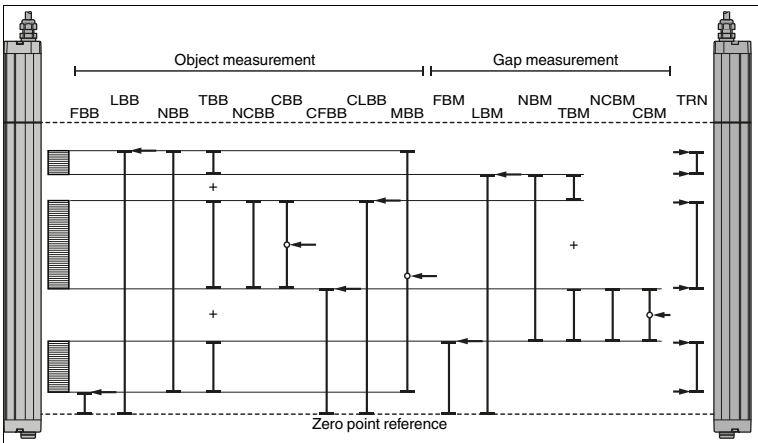

Figure 5.2 Overview of all the Light Grid's Measurement Value Modes

The measured values are based on the zero point reference in unit of millimetres (mm). For operation with cable outlet downwards, the receiver unit can be configured via IO-Link for the zero-point reference on the cable side.

List of Abbreviations

Abbreviation		Description
Object measurement		
FBB	First beam blocked	Lowest object position (based on the zero point reference)
LBB	Last beam blocked	Highest object position (based on the zero point reference)
NBB	Number of beams blocked	Object height from lowest to highest position, $NBB = LBB - FBB$
TBB	Total beams blocked	Total object height of all partial objects
NCBB	Number of consecutive beams blocked	Height of the largest partial object
CBB	Central beam blocked	Middle object position of the largest partial object (based on the zero point)
CFBB	Contiguous first beam blocked	Lowest position of the largest contiguous partial object
CLBB	Contiguous last beam blocked	Highest position of the largest contiguous partial object
MBB	Middle beam blocked	Middle object position across all partial objects (based on the zero point)
Gap measurement		
FBM	First beam made	Lowest gap position, across all partial objects, on the upper edge of the lowest partial object
LBM	Last beam made	Highest gap position, across all partial objects, on the lowest edge of the highest partial object
NBM	Number of beams made	Gap height within all partial objects, across all partial objects, $NBM = LBM - FBM$
TBM	Total beams made	Gap height as the sum of all gap areas within the upper object limits
NCBM	Number of consecutive beams made	Gap height of the largest contiguous gap area, within the outer object limits
CBM	Central beam made	Middle gap position of the largest contiguous gap area, within the outer object limits
Additional functions		
TRN	Number of TRraNsitions	Number of status transitions from "interrupted beam" to "uninterrupted beam" and vice versa. If the number is odd, one of the two synchronous beams has been interrupted by an object. The value is a unitless number.

Object identification

The light grid can identify solid objects or object with gaps by evaluation of interrupted beams. The switching signal Q is active if a object is detected or identified.

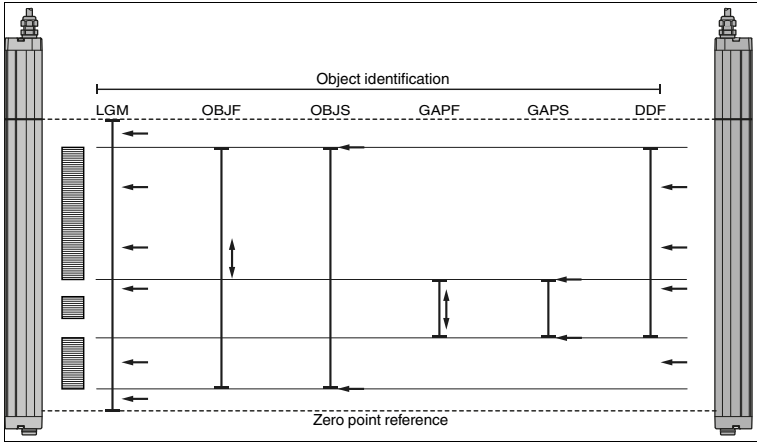

Figure 5.3 Overview of all object identification modes

List of Abbreviations

Abbreviation		Description
LGM	Light grid mode	Any object is detected if at least one beam is interrupted within the detection field and outside the blanking fields.
OBJF	Floating object identification	A floating object is detected if the height corresponds to the distance of the parametrized positions of the object field.
OBJS	Static object identification	An object is detected if the upper and lower limits match the parametrized positions of the object field.
GAPF	Floating gap identification	An object is detected if the gap height matches the distance of the parametrized positions of the gap field.
GAPS	Static gap identification	An object is detected if the upper and lower limits of a gap match the parametrized positions of the gap field.
DDF	Defined detection field	Any object is detected if at least one beam is interrupted within the parametrized positions of the object field and outside of the blanking fields.

Blanking fields

You can parametrize up to 2 blanking fields in the light grid. These fields are parameterized and activated independently. The object identification and evaluation of measurement values functions are not possible within blanking fields.

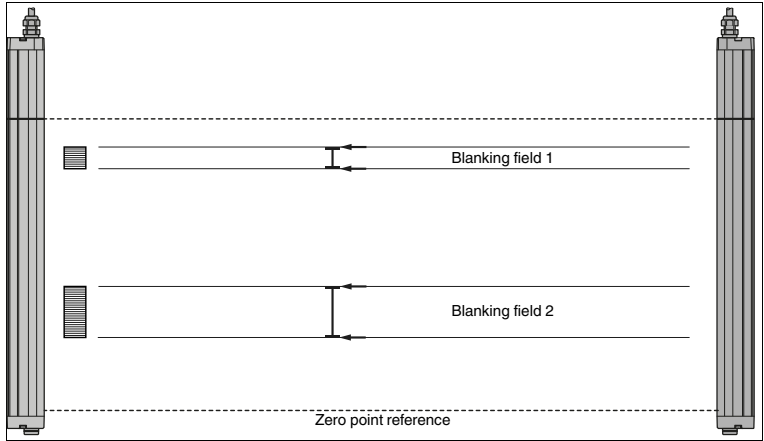

Figure 5.4 Overview of the blanking fields

6 Appendix

6.1 Technical Data

General specifications

Effective detection range	Standard : 0.3 ... 6 m
Threshold detection range	7.5 m
Light source	IREC
Light type	modulated infrared light , 850 nm
Detection field	
Beam mode	Factory setting: three beam crossing, deactivateable
Blanking fields	max. 2 blanking fields, adjustable
Beam spacing	LGM8 = 8.33 mm; LGM17 = 16.67 mm; LGM25 = 25 mm; LGM50 = 50 mm
Number of beams	
Operation mode	Emitter: Emitter power adjustable in two ranges
Optical resolution	With single beam scan: see beam spacing With three beam crossing: 4/8.5/12.5/25/50 mm. Only in the range of 25 % ... 75 % of the detection field
Angle of divergence	10 °
Ambient light limit	> 50000 Lux (if external light source is outside the opening angle)

Functional safety related parameters

	LGM8	LGM17	LGM25	LGM50
MTTF _d	21 a	25 a	34 a	56 a
Mission Time (T _M)	20 a	20 a	20 a	20 a
Diagnostic Coverage (DC)	60 %	60 %	60 %	60 %

Indicators/operating means

Operation indicator	LED green: constantly on - power-on double pulse flashing (0.8 Hz) - undervoltage flashing (4 Hz) - short circuit flashing with short interruptions (1 Hz) - IO-Link mode
Status indicator	Emitter: LED yellow constantly on - high emitter power constantly off - low emitter power flashing (8 Hz) - error message Receiver: LED yellow: constantly on - object detected constantly off - no object detected flashing (4 Hz) - below stability control limit flashing (8 Hz) - error message
Control elements	Receiver: 2 touch buttons for programming

Electrical specifications

Operating voltage	18 ... 30 V DC
Ripple	10 %
No-load supply current	Emitter ≤ 50 mA Receiver: ≤ 150 mA (without outputs)
Time delay before availability	

Interface

Interface type	IO-Link (pin 4)
IO-Link revision	1.0
COM-Mode	COM 2 (38.4 kBaud)
Min. cycle time	2.3 ms
Process data width	16 bit
SIO mode support	yes
Device ID	1050369 ... 1050400 (0x100701 ... 0x100720)

Input

Test input	Emitter switch-off with +UB or 0 V at pin 4 (emitter)
Function input	Range input activation from 1.6 m with +UB or 0 V on pin 2 (emitter) Teach-In input for parameterization on pin 8 (receiver)

Output

Pre-fault indication out-put	Stability Control (SC) 1 PNP, short-circuit protected, reverse polarity protected on pin 2 (receiver)
Switching type	Factory setting: dark on , Switchable to light-on mode

Signal output	Command interface: Pin 4 IO-Link interface C or used as switching output Q; 1 short-circuit proof reverse polarity protected push-pull output (receiver) Switch output: Pin 5 switching output Q; 1 short-circuit proof reverse polarity protected push-pull output (receiver) synchronized with pin 4
Switching threshold	Factory setting: The signal tracking for the threshold value is deactivated, increasing the optical resolution by a maximum of 4 mm; switchable to active signal tracking
Switching voltage	max. 30 V DC
Switching current	max. 100 mA
Voltage drop	≤ 2 V DC
Switching frequency	
Response time	
Timer function	Off-delay programmable from 0 ... 1.25 s in 5 ms steps (adjustment via IO-Link only)

Conformity

Communication interface	IEC 61131-9
Product standard	EN 60947-5-2

Approvals and certificates

Protection class	III (IEC 61140)
UL approval	cULus Listed
CCC approval	CCC approval / marking not required for products rated ≤36 V

Ambient conditions

Ambient temperature	-30 ... 60 °C (-22 ... 140 °F)
Storage temperature	-30 ... 70 °C (-22 ... 158 °F)

Mechanical specifications

Conductor cross section	min. 0.25 mm ²
Housing length L	
Degree of protection	IP67
Connection	Emitter: connecting cable with 4-pin, M12 x 1 connector , 330 mm total length Receiver: connecting cable with 8-pin, M12 x 1 connector , 350 mm total length
Material	

LGM Series

Appendix

Housing	extruded aluminum section , Silver anodized
Optical face	Plastic pane , Polycarbonate
Mass	
Cable length	max. 30 m

ООО "РусАвтоматизация"

454010 г. Челябинск, ул. Гагарина 5, оф. 507
тел. 8-800-775-09-57 (звонок бесплатный), +7(351)799-54-26, тел./факс +7(351)211-64-57
info@rusautomation.ru; русавтоматизация.рф; www.rusautomation.ru