

The invisible hand for more convenient world

Autonics sensors & controllers

50mm Small Hybrid Recorder

KRN50 Series

USER MANUAL

CE



Thank you very much for selecting Autonics products.

For your Safety, please read the following before using.

Preface

Thank you for purchasing Autonics product.





Please familiarize yourself with the information contained in the **Safety Precautions** section before using this product.

This user manual contains information about the product and its proper use, and should be kept in a place where it will be easy to access.

User Manual Guide

- Please familiarize yourself with the information in this manual before using the product.
- This manual provides detailed information on the product's features. It does not offer any guarantee concerning matters beyond the scope of this manual.
- This manual may not be edited or reproduced in either part or whole without permission.
- A user manual is not provided as part of the product package. Visit our web site (www.autonics.com) to download a copy.
- The manual's content may vary depending on changes to the product's software and other unforeseen developments within Autonics, and is subject to change without prior notice. Upgrade notice is provided through our homepage.
- We contrived to describe this manual more easily and correctly. However, if there are any corrections or questions, please notify us through our homepage.

User Manual Symbols

Symbol	Description
 Note	Supplementary information for a particular feature.
 Warning	Failure to follow instructions can result in serious injury or death.
 Caution	Failure to follow instructions can lead to a minor injury or product damage.
 Ex.	An example of the concerned feature's use.
※ 1	Annotation mark.

Safety Precautions

- Please follow safety precautions to ensure the safe and proper use of the product and prevent accidents, as well as minimizing possible hazards.
- Safety precautions are categorized as Warnings and Cautions, as defined below:

 Warning	Warning	Failure to follow instructions can result in serious injury or death.
--	----------------	---

 Caution	Caution	Cases that may cause minor injury or product damage if instructions are not followed.
--	----------------	---



Warning

- In case of using this unit with machinery (Ex: nuclear power control, medical equipment, ship, vehicle, train, airplane, combustion apparatus, safety device, crime/disaster prevention equipment, etc) which may cause damages to human life or property, it is required to install fail-safe device.
It may cause a fire, human injury or property loss.
- It must be mounted on panel.
It may cause electric shock.
- Do not connect, inspect or repair this unit when power is ON.
It may cause electric shock.
- Check input power specification and check power terminal number when wiring power cable.
It may cause a fire or damage by a fire.
- Lithium battery is used in this product, do not disassemble or burn up this unit.
It may cause an explosion.
- Do not touch the product or connect terminal within 30 sec. after turn off the power.
It may cause electric shock.
- F.G. terminal should be isolation grounded. Grounded wire should be over AWG16(1.25 mm²).
It may cause electric shock.

- Do not insert your finger or object into the vent of this unit.
It may cause electric shock or human injury.
- Do not disassemble or modify this unit. Please contact us if it is required.
It may cause a fire, human injury or property loss.



Caution

- This unit shall not be used outdoors.
It may shorten the life cycle of the product or cause electric shock.
- When wiring power input terminal and measuring input terminal, power line should be over AWG 20(0.50mm²). Terminal screw should be tightened with 0.74 N•m to 0.90 N•m torque.
Please observe the rated specifications.
It may cause shorten the life cycle of the product and cause a fire.
- Do not use the load over the rated switch capacity value of relay contact part.
It may cause insulation failure, contact melt, contact failure, relay broken, fire etc.
- When connecting magnet contact as load of relay contact output, connect surge absorber on coil part of contact.
It may cause malfunction.
- In cleaning the unit, do not use water or organic solvent. And use dry cloth.
It may cause electric shock or a fire.
- Do not use this unit in place where there is flammable, explosive gas, humidity, direct light, radiant heat, vibration, or impact.
It may cause a fire or explosion.
- Do not inflow dust or wire dregs into the unit.
It may cause a fire or malfunction.
- Wire properly after checking the terminal polarity.
It may cause a fire or explosion.
- Wire properly after checking the terminal polarity when connecting temperature sensor.
It may cause malfunction.
- Connection should be followed as connection diagram of this manual.
Before power ON, check the connection correct.
It may cause a fire.

- Do not touch terminal during dielectric or insulation resistance test.
It may cause electric shock.
- It is recommended to use insulation transformer and noise filter power in case of too much noise from power. Attach noise filter on the grounded panel, etc. Wire between noise filter output part and power terminal of the product should be short as possible.
It may cause damage to the product, malfunction by surge, etc.

Table of contents	
Preface.....	iii
User Manual Guide	iv
User Manual Symbols.....	v
Safety Precautions.....	vi
Table of contents.....	ix
1. Overview.....	11
1.1 Features	11
1.2 Component and sold separately	12
1.2.1 Components	12
1.2.2 Sold separately.....	13
1.3 Ordering information.....	14
1.4 Part descriptions.....	15
2. Specifications	17
2.1 Input type and range.....	19
3. Dimensions.....	21
4. Connections	23
5. Installation	25
5.1 Installation places.....	25
5.2 Installation.....	26
5.2.1 Panel mounting	26
6. Functions	27
7. General operation and parameter setting menu.....	29
7.1 Operation mode.....	29
7.2 Operation procedure	29
7.3 Setting keys	30
7.4 Parameter groups	33

Table of contents

8. Recording	35
8.1 Recording preparation	35
8.2 Explanation for input function and setup	36
8.2.1 Input type setup	36
8.2.2 Alarm function setup	47
8.2.3 Recording setup	59
8.2.4 Display information function	78
9. Communication	83
9.1 ModBus address Map	85
10. DAQMaster	91
10.1 Overview	91
10.2 Features	92
10.3 Dedicated function for KRN50	93

1. Overview

1.1 Features

- 50mm thermal transfer method of paper recorder
- Data logger function for recording without paper
- Supports RS485 communication and dedicated communication port to set or monitor parameters in real-time by PC/PLC
- Multi-input with high accuracy 0.2% level (RTD, TC, Analog)
- 2-channel simultaneous recording in graphic mode and digital mode
- High visibility and easy setting by LCD dot matrix
- Supports various option I/O function
- Small size(W96×H96×L100 mm), light weight

1.2 Component and sold separately

1.2.1 Components



[KRN50]

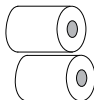



Mounting Bracket
2EAManual
1EAChart paper
2EA50Ω B class high-
accuracy resistor(0.1%)
2EA

Note

Before using KRN50, check the component.
If any component is left out or damaged, contact our company or seller.
Autonics service center: +82-32-820-2343

1.2.2 Sold separately

Communication converter

SCM-38I (RS232C to RS485 converter)	SCM-US48I (USB to RS485 converter)
 A small, white, rectangular electronic device with a black RS232C connector on the front and a small label that reads "SCM-38I".	 A small, white, rectangular electronic device with a black USB connector on the front and a small label that reads "SCM-US48I".
SCM-US (USB to Serial converter)	SCM-WF48(available soon) (Wi-Fi to RS485/USB converter)
 A black cable with a USB-A connector on one end and a 3.5mm audio jack connector on the other, with a small cylindrical component in the middle.	 A small, white, rectangular electronic device with a black antenna on top, a USB connector on the front, and a label that reads "SCM-WF48".

1.3 Ordering information

KRN50	—	2	0	0	4	—	4	0		
									Power supply	
									0	100-240 VAC 50 to 60 Hz
									1	24VDC
									Option output	
									0	None
									4	RS485 communication output
									Alarm output	
									0	None
									2	Alarm output 2EA ^{※1}
									4	Alarm output 4EA ^{※2}
									CH2 control output	
									0	None
									CH1 control output	
									0	None
									Number of input channels	
									1	1-channel
									2	2-channel
									Item	
									KRN50	Thermal Line Recorder (50 mm)



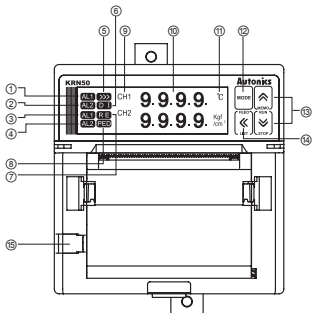

※1: When selecting this for 2 CH model, 2EA alarm outputs for CH1 are available. In other words, you cannot set 1EA for CH1 and 1EA for CH2.

※2: It is selectable only for 2 CH model.

1.4 Part descriptions



- ① CH 1 alarm(AL1) output indicator
: Turns ON when AL1 of input channel 1 operates.
- ② CH 1 alarm(AL2) output indicator
: Turns ON when AL2 of input channel 1 operates.
- ③ CH 2 alarm(AL1) output indicator
: Turns ON when AL1 of input channel 2 operates.
- ④ CH 2 alarm(AL2) output indicator
: Turns ON when AL2 of input channel 2 operates.
- ⑤ Recording run(▶▶▶)/Recording stop(■) indicator
: ▶▶▶ turns ON when start recording (RUN). ■ turns ON when stopping recording (STOP).
- ⑥ Digital input indicator
: Turns ON when setting digital input.
- ⑦ Recording reservation(RE) indicator
: RE turns ON when recording reservation operates.
- ⑧ Recording paper status(PEP)indicator
: PEP turns ON if running out of recording paper during recording (RUN).
- ⑨ Channel(CH) display part
: Displays input channel of currently displayed PV on the PV display part.
- ⑩ PV display part
: In RUN mode, displays PV of the current channel.
In setting mode, displays parameters and mode setting values.
- ⑪ Unit display part: Unit of relevant channel is indicated.

- ⑫ **MODE** key: Used to enter setting mode and changing SV mode.
- ⑬   key: Used to move parameters or increase/decrease digits.
 key: Digital memo key,  key: Recording Run/Stop key
- ⑭  key: Used to move parameters to upper group or move digits
Paper feeding key (STOP), printing parameter setting information key (RUN)
- ⑮ PC loader port
: It is a PC loader port for serial communication to set or monitor parameters by PC.
Used to connect SCM-US (USB to Serial converter, sold separately).

2. Specifications

Series		KRN50
Power supply	AC voltage	100-240 VAC 50 to 60 Hz
	DC voltage	24 VDC
Allowable voltage range	AC voltage	85 to 110% of rated voltage
	DC voltage	90 to 110% of rated voltage
Power consumption	AC voltage	Max. 34 VA
	DC voltage	Max. 79 W
Display method		LCD Dot matrix Display (resolution 128×32 Dot)
Input type	RTD	JPt100Ω, DPt100Ω, DPt50Ω, Cu100Ω, Cu50Ω (5 types)
	TC	K, J, E, T, B, R, S, N, C, G, L, U, PLII (13 types)
	Analog	· Voltage: -50.0-50.0 mV, -199.0-200.0 mV, -1.000-1.000 V, -1.00-10.00 V (4 types) · Current: 0.00-20.00 mA, 4.00-20.00 mA (2 types) ※For current input, connect external 50 Ω B class (0.1%) high-accuracy resistor
Event input	Contact	Input ON: Max. 1 kΩ, OFF: Min. 100 kΩ
	Non-contact	Input ON: Residual voltage max. 1 V, OFF: Leakage current max. 0.05 mA
	Outflow current	Approx. 0.3 mA
Display accuracy ^{※1}	RTD	±0.2%F.S.±1digit(25±5 °C), ±0.3%F.S.±1digit(0 to 20 °C, 30 to 50 °C)
	TC	Below -100 °C for TC is ±0.4%F.S.±1digit
	Analog	(TC-K2 has same accuracy with TC-K1 and -200 to 1350 °C range.)
Record accuracy		±0.5%F.S.
Alarm output		CH1(AL1, AL2), CH2(AL1, AL2) Relay output(250 VAC/30 VDC 3 A 1 a)
Alarm output hysteresis		ON/OFF interval setting for alarm output : 1 to 999 digit variable
Communication output		RS485 communication output(Modbus RTU protocol)
Set method		Setting by front keys
Sampling cycle		500 ms/channel×2 channels = 1000 ms

Dielectric strength		2300 VAC 50/60 Hz for 1 min. (charging terminal of the other polarity)
Vibration		0.75 mm amplitude at frequency of 10 to 55 Hz (for 1 min.) in each of X, Y, Z directions for 1 hour
Relay life cycle		Mechanical: Over 5,000,000 operations, Electrical: Over 100,000 operations
Insulation resistance		Over 100 M Ω (at 500 VDC megger)
Noise resistance		Square shaped noise by noise simulator (pulse width 1 μ s) \pm 2 kV
Print	Method	Direct thermal line print
	Resolution	8 dot/mm
	Dots	384 dot/Line
	Life cycle	50 km
Record	Graphic mode	· Record speed(recording paper speed) : 10, 30, 60, 120, 240, 480, 940 mm/hour · Memo cycle : 30 s, 1 m, 5 m, 10 m, 15 m, 30 m, 1 h, 2 h, 3 h, 4 h, 8 h, 16 h, 24 h
	Digital mode	TEXT mode record cycle: 00 m 05 s to 99 m 59 s
	Paper	Thermal Direct Receipt Paper (57 mm \times 16 m)
	Paper supply method	Clamshell Type
	Language	Korean, English
Environment	Ambient temperature	0 to 50 $^{\circ}$ C, storage: -20 to 60 $^{\circ}$ C
	Ambient humidity	35 to 85%RH, storage: 35 to 85%RH
Approval		CE
Unit weight		Approx. 700 g

※1: Exception range for measurement accuracy by each sensor

- J: $-200 \leq T \leq -100 \pm 2.7$ $^{\circ}$ C
- R, S, C, G: $0 \leq T \leq 100 \pm 5.2$ $^{\circ}$ C
- B: Below 400 $^{\circ}$ C, there is no accuracy standards.
- U, T: $-200 \leq T \leq -100 \pm 3.5$ $^{\circ}$ C, $-100 \leq T \leq 400 \pm 2.5$ $^{\circ}$ C

※Environment resistance is rated at no freezing or condensation.

2.1 Input type and range

Input type		Dot	Display	Input range(°C)		Input range(°F)	
Thermocouple	K(CA)	1	TC-K1	-200	to	1350	-328 to 2462
		0.1	TC-K2	-199.9	to	999.9	-199.9 to 999.9
	J(IC)	1	TC-J1	-200	to	800	-328 to 1472
		0.1	TC-J2	-199.9	to	800.0	-199.9 to 999.9
	E(CR)	1	TC-E1	-200	to	800	-328 to 1472
		0.1	TC-E2	-199.9	to	800.0	-199.9 to 999.9
	T(CC)	1	TC-T1	-200	to	400	-328 to 752
		0.1	TC-T2	-199.9	to	400.0	-199.9 to 752.0
	B(PR)	1	TC-B	100	to	1800	212 to 3272
	R(PR)	1	TC-R	0	to	1750	32 to 3182
	S(PR)	1	TC-S	0	to	1750	32 to 3182
	N(NN)	1	TC-N	-200	to	1300	-328 to 2372
	C(TT) ※1	1	TC-C	0	to	2300	32 to 4172
	G(TT) ※2	1	TC-G	0	to	2300	32 to 4172
	L(IC)	1	TC-L1	-200	to	900	-328 to 1652
		0.1	TC-L2	-199.9	to	900.0	-199.9 to 999.9
	U(CC)	1	TC-U1	-200	to	400	-328 to 752
		0.1	TC-U2	-199.9	to	400.0	-199.9 to 752.0
	Platinel II	1	TC-P	0	to	1390	32 to 2534
	RTD	Cu50Ω	0.1	CU50	-199.9	to	200.0
Cu100Ω		0.1	CU100	-199.9	to	200.0	-199.9 to 392.0
JPt100Ω		1	JPT1	-200	to	600	-328 to 1112
		0.1	JPT2	-199.9	to	600.0	-199.9 to 999.9
DPT50Ω		0.1	DPT50	-199.9	to	600.0	-199.9 to 999.9
DPT100Ω		1	DPT1	-200	to	600	-328 to 1112
	0.1	DPT2	-199.9	to	600.0	-199.9 to 999.9	
Analog	Voltage	-50.0	- 50.0 mV	50 mV	-1999 to 9999 (display range depends on the decimal point position)		
		-199.9	- 200.0 mV	200 mV			
		-1.000	- 1.000 V	1 V			
		-1.00	- 10.00 V	10 V			
	Current	0	- 20 mA	0-20			
		4	- 20 mA	4-20			

※1: C(TT): Same as existing W5(TT).

※2: G(TT): Same as existing W(TT).

3. Dimensions

(1) KRN50

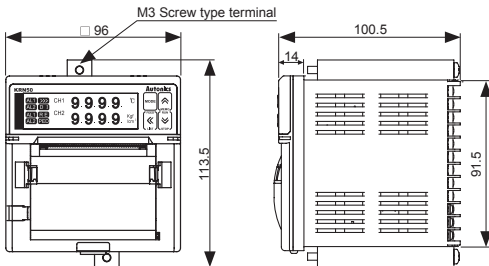

(2) Panel cut-out

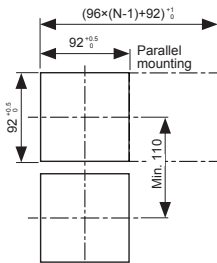

·N = Quantity

·Panel thickness: 1-4 mm

4. Connections

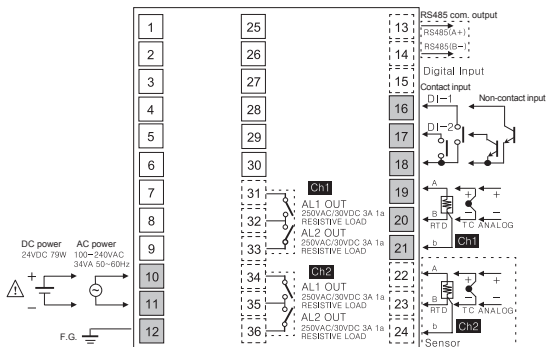

- ※ Shaded terminals are for the standard model. (power terminal, CH1 input terminal, DI input terminal)
- ※ Dot line terminals are for the option model. (CH2 input terminal, alarm output terminal, communication output terminal)
- ※ The DC power model does not have F.G.
- ※ When using 2-wire RTD, short B and b terminals.
- ※ For current input, connect external 50ΩB class(0.1%) high-accuracy resistor.

5. Installation

5.1 Installation places

Install this unit in place where the below conditions are satisfied.

- Instrument Panel
This recorder is panel mounting type.
- Place where ventilation is well
To prevent from malfunction and damage by overheating (use temperature range: 0 to 50°C), install this unit where ventilation is well.
In case installing several KRN50, space each other by panel cut-out.
- Place where vibration is not severe
If there is too much vibration, it may cause malfunction such as print error.
- In case of temperature measurement with thermocouple temperature sensor at the place where temperature is fluctuated, data error may occur. You should warm-up this unit over 30 min. to acquire accurate data before using it.
- At the place where temperature and humidity is fluctuated excessively, recording paper color may be changed.

5.2 Installation

5.2.1 Panel mounting

- i. Install KRN50 on the processed panel as panel cut-out diagram. Mount fixing brackets on upper/lower parts.

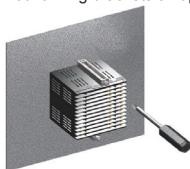

- ii. Tighten fixing brackets on upper/lower parts to fix on the panel with phillips screwdriver (+). (Torque: 0.3N•m)
- iii. Wire cables to the rear terminal block.



Note

If using only 1 channel in case of 2 channel model, please short-circuit the input channel (+, - input) not used in order to prevent from noise influence.

If cable connected with recorder has strong power, it may cause damage to recorder or terminal block.

Input must be installed as far as possible from power line.

Terminal wiring must be divided from high-voltage and high-current power line in order to prevent from electricity failure and self-induction noise. Also please avoid parallel wiring or same wiring with power line.

It may be effective if dividing by means of pipe or duct or using shield cable or twisted-pair cable.

Same compensating wire must be used for precise measurement when thermocouple lead wire need to extend. If not, it may cause an accidental error.

When RTD lead wire need to extend, please use it with small resistance value and be equal for resistive value to 3 lead wires.



Warning

Connect wiring after power off in order to prevent from electric shock. Check input specifications in order to prevent from any damages.

6. Functions

KRN50 recorder is able to measure Thermocouple, RTD, voltage (1V DC, 10V DC, 50mV DC, 200mV DC), current (DC 0 to 20mA, DC 4 to 20mA) signal by total 2 input channels. Measured signal records by digital and graph type through setting a variety of recording speed.

- Alarm

Input 1 channel can have 2 alarm outputs. Alarm output is operating by a kinds of modes (None, Latch, Stand-by, Latch+Stand-by) through High-limit, Low-limit, Sensor break, Paper end function. Alarm outputs by relay contact.

- Recording

Measured signal records by digital and graph type. Recording speed is able to set by 5sec to 99min 59sec in case of digital mode (Numerical record) and by 10 to 960mm/h in case of graph mode. It has memo function recording data at the necessary time and is able to output time, date, alarm information, error message, parameter list and so on.

- Display

Measured value is indicated by number on LCD display and time, alarm, error information, etc. are displayed.

- Communication function

It is able to use RS-485 communication and communication protocol uses ModBus RTU and communicates with the upper devices, PC or PLC.

- Data backup function (Record Back-up)

It is similar to data logger function. In case of graph mode and 10mm/h recording speed, approx. 10-day-data is able to be saved in EEPROM memory. Therefore user can output the saved data from the memory by graph or digital type. Also even though chart paper is exhausted all, data is able to be saved to the saving space according to recording speed.

- Other functions

Feeding function and recording run/stop function are able to be used by front key or communication at the status of recording stop. Also recording reservation function is able to start or stop recording at the suitable time period user wants.

7. General operation and parameter setting menu

7.1 Operation mode

Recorder has 3 kinds of operation modes.

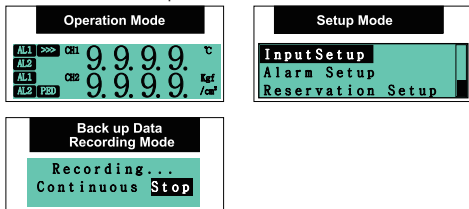

- **Common operation mode**
This mode operates when normal operation. This mode operates when power on.
- **Setting mode**
This mode is to set the parameters as like input range, alarm, recording speed, etc. This mode is able to set even if operation does not stop on common operation mode.
- **Backup data recording mode (Record backup data recording mode)**
This mode is to record the saved data by means of data logger function. It is also unnecessary for operation stop.









7.2 Operation procedure

It is the introduction when this recorder operates initially.

- **Ready to record**
Put chart paper in paper holder after cutting the glued part (chart paper is installed in recorder as factory default). If necessary, change time and date (they are set as factory default).
- **Set input and relevant parameter**
Set relevant parameter (input type, alarm, record speed) according to input sensor.
- **Record and display measuring value**
If necessary, press key for recording Run / Stop. Also mode is able to be changed by measuring value display mode relevant key.

7.3 Setting keys

(1) Enter into the setting mode

- If pressing **MODE** key for 3 sec, it enters into setting mode. After then the upper setting menu refer to as the figure of 7.2 is indicating and the cursor is placed on relevant the upper setting menu. Scroll bar at the right side shows the rest of the setting menu.
- If moving from the upper setting menu to the next step menu, please use ,  key.
- If pressing **MODE** key, it is able to move from the current menu to the lower setting menu. (For moving from the lower setting menu to the upper setting menu, please use  key.)
- If moving from the lower setting menu to the next step menu, please use ,  key.
- If entering into the setting category at the lower setting menu, the cursor flashes on the setting category. Then, user is able to change the setting category by means of  or ,  key.

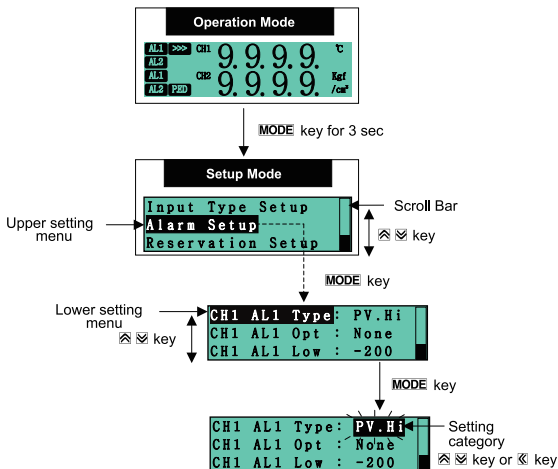

(2) Get out of the setting mode

- If pressing **MODE** key after changing the setting category, setting value is saved and moving to the next lower setting menu.
- The lower setting menu is able to be selected by **⏏**, **⏏** key and if pressing **⏏** key, moving to the upper setting menu.
- If pressing **MODE** key for 3 sec when the cursor is placed at the lower setting menu, it is able to move to the setting mode from general operation mode and operate according to setting value.

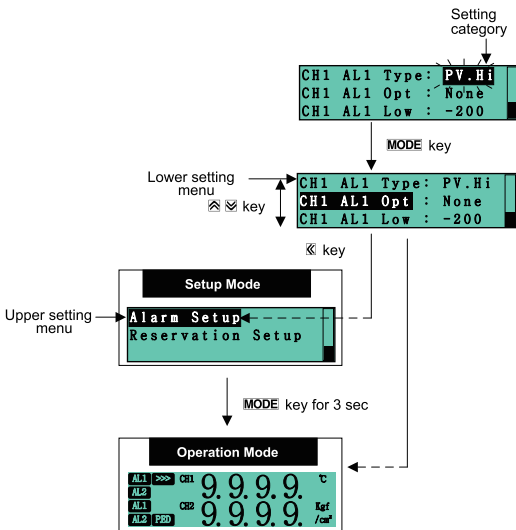

(3) Change the setting category

If pressing **MODE** key after changing the setting category by \leftarrow , \rightarrow key, it is saved and moved to the setting menu.

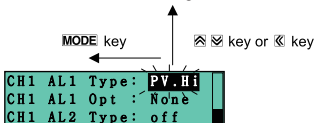
**(4) Insert setting value**

After moving the cursor to the position user wants to the left by \leftarrow key, it is able to change the value by \leftarrow , \rightarrow key. Especially the fourth position of number is able to change to either number or sign.

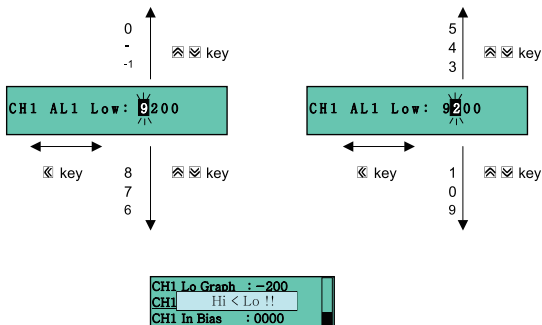

If pressing **MODE** key at the status of wrong value and save it when changing setting value, it indicates Error code as above.

7.4 Parameter groups

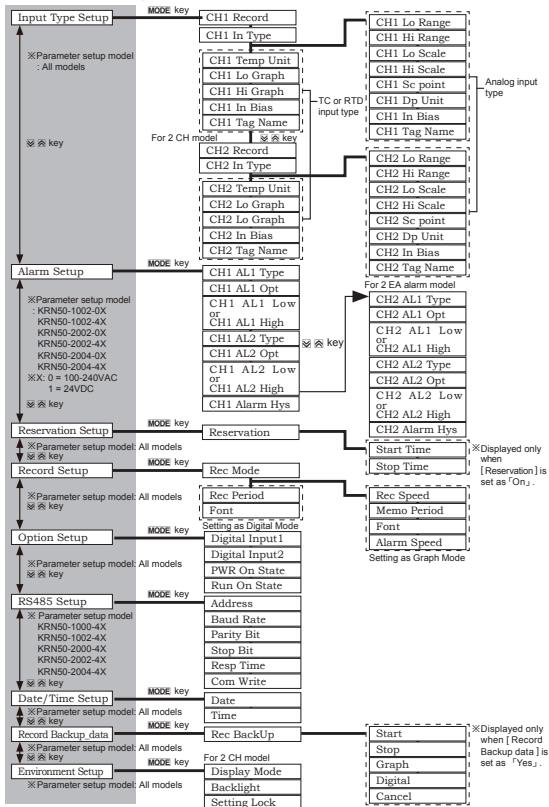

8. Recording

8.1 Recording preparation

(1) Setting and checking date/time

This function is to set date(Year, Month, Day) and time(Hour, Min. Sec.) of recorder. When using recorder at the first time, user must check setting time because recording time follows setting time. When entering into parameter mode according to previous setting time, the entry time is indicated.

(2) Current date [Date]

- Set range: 00y01m01d to 99y12m31d (unit: -)

Day is set automatically.

(3) Current time [Time]

- Set range: 00:00:00 to 23:59:59

• Setting date and time

- If pressing **MODE** key for 3 sec, it enters into the upper setting menu.
- If pressing **MODE** key after selecting Date/Time Setup by **⏏**, **⏏** key, it enters into the lower setting menu from the upper setting menu.

```
Date/Time Setup
Record Backup_data
Environment Setup
```

⏏ **⏏** key or **MODE** key

- If pressing **MODE** key after moving the cursor to Date by **⏏**, **⏏** key, it enters into the date setting category. Then if the cursor flashes at the position for change, moving the cursor by **⏏** key and setting the value by **⏏**, **⏏** key. After then if pressing **MODE** key, setting value is saved.

⏏ **⏏** key

```
Date : 00y01m01d WED
Time : 00h00m00s
```

MODE key



⏏ **⏏** key or **⏏** key

```
Date : 00y01m01d WED
Time : 00h00m00s
```

- Time setting method is same as 3rd.

⏏ **⏏** key

```
Date : 00y01m01d WED
Time : 00h00m00s
```

MODE key



⏏ **⏏** key or **⏏** key

```
Date : 00y01m01d WED
Time : 00h00m00s
```

8.2 Explanation for input function and setup

8.2.1 Input type setup

(1) CH Using/Recording [CH□ Record]

For Ch1 and Ch2, this function is that user is able to select the channel to use for indicating PV on display and recording to chart paper.

If using/recording the relevant channel, the mode of the relevant channel must be 'On' however if not, it must be 'Off'.

If the mode of any channel is 'Off', this channel is not able to indicate channel indication and PV on display and to record anything.

If the mode of any channel is 'Off', relevant input setting parameter of this channel is not indicated automatically.

- Set range: On (using/recording) / Off(not using/recording)
- Factory default: Off (unit: -)

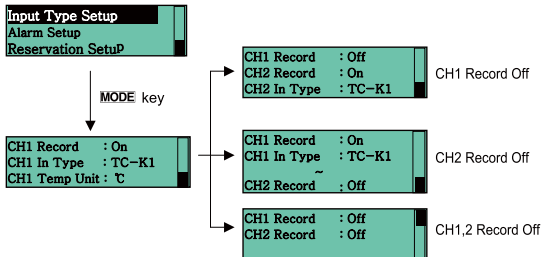

Note

Regarding saved data by record backup, if CH1,2 Record : ON, OFF function is changed, previous record backup data is removed and start saving the data from the current modified time. Therefore please be careful for setup.

(2) Input specifications and range [CH□ In Type]

This recorder has multi input type and user voluntarily is able to select each input type for CH1 and CH2 separately.

(Ex: set as CH1: DPT1, CH2: TC-K1)

- Set range: temperature range of each input type and sensor
- Factory default: TC-K1 (unit: -)

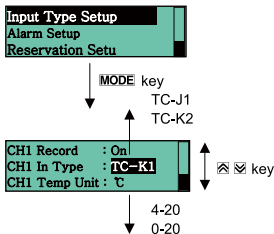
**Note**

If changing input type, saved data by record backup is removed and it starts saving the data from the modified current time. Therefore please be careful for setup.

(3) Temperature unit setting by input type [CH□ Temp Unit]

For temp. sensor input, using temp./indicating temp. unit is able to select to Celsius(°C) or Fahrenheit(°F) voluntarily.

When temp. unit conversion (°C ↔ °F), PV value is changed according to unit conversion table.

In case of analog input type, this parameter [CH□ Temp Unit] is not indicated.

When temp. unit conversion, relevant bias value is initialized and parameter setting value excluding bias value holds previous setting value.

- Set range: °C / °F
- Factory default: °C (unit: -)

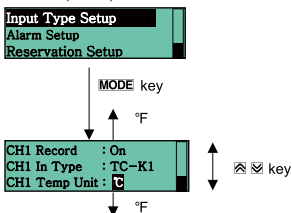
**(4) Graph low-limit scale value [CH□ Lo Graph]**

This function is to set low-limit scale value of graph within input range of each input type.

- Set range: Min. range by each sensor input type to Graph high limit scale value[CH Hi Graph]- F.S. 5%
- Factory default: -200(unit: Digit)

(5) Graph high-limit scale value [CH□ Hi Graph]

This function is to set high limit scale value of graph within input range of each input type. For analog input type, this parameter is not displayed.

- Set range: Graph low-limit scale value[CH Lo Graph] + F.S. 5% to Max. range by each sensor input type
- Factory default: 1350(unit: Digit)

Input Type Setup
Alarm Setup
Reservation Setup

↓ MODE key

Lo Graph setup

CH1 Lo Graph	: -200
CH1 Hi Graph	: 1350
CH1 In Bias	: 0000

↑ In case of TC K-1
Setting range : -200 to 1272
⏏ ⏏ key
(Increasing/Decreasing value)

← ⏏ key(Moving the position of number)

Hi Graph setup

CH1 Lo Graph	: -200
CH1 Hi Graph	: 1350
CH1 In Bias	: 0000

↑ In case of TC K-1
Setting range : 1350 to -122
⏏ ⏏ key
(Increasing/Decreasing value)

← ⏏ key(Moving the position of number)

CH1 Lo Graph	: -200
CH1	Hi < Lo !!
CH1 In Bias	: 0000

CH1 Lo Graph	: -200
CH1	Over range !!
CH1 In Bias	: 0000

When High / Low graph setup with wrong value and pressing **MODE** key for save, error message is indicated as above.(Refer to Over Range, Hi < Lo of 8.2.4 Display information function (1) Error) Then if pressing **MODE** key again, it returns to previous value.

Graph high/low scale value setting

**Note**

In case of temp. sensor input (TC, RTD), this function is to set graph scale value for record to chart paper and user voluntarily is able to assign the recording range.

If specified indicating section is recording in detail by graph curve, it is used.

If the recording value exceeds graph high/low-limit scale, it records on empty space of chart paper at the left/right side of graph (approx. 1mm point) as following figure.

In case of the recording start position of digital memo, even though graph high/low-limit scale range is exceeded, actual value is recorded within high/low-limit input range.

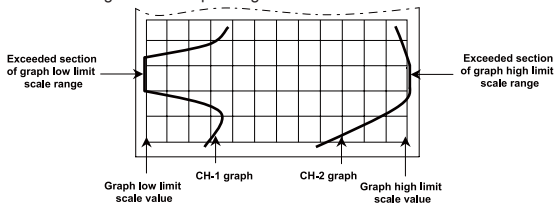

(6) Low-limit input range [CH□ Lo Range]

This function is to assign and limit the actual using low-limit input value within input range.

- Set range: Min. input range to high-limit input value[CH□ Hi Range]-F.S 5%
- Factory default: Min. input range (unit: -)

(7) High-limit input range [CH□ Hi Range]

This function is to assign and limit the actual using high limit input value within input range.

- Set range: Low-limit input value[CH□ Lo Range]+ F.S 10% to max. input range
- Factory default: Max. input range (unit: -)

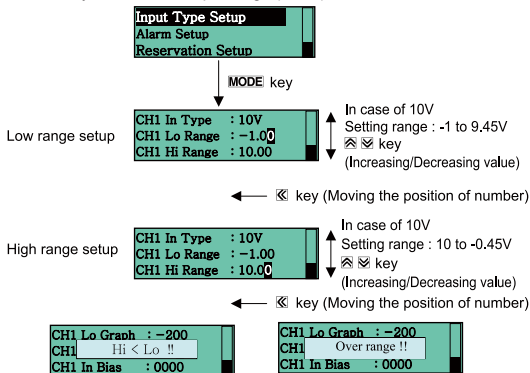

When High / Low graph setup with wrong value and pressing **MODE** key for save, error message is indicated as above.

**Note**

Analog input/scale setting

In case of analog input type (Voltage, Current input), user is able to assign input range (High/Low-limit input value) and this function is to support proper indication for user environment through scale value for assigned input range (High/Low-limit input value) setup.

Graph scale of chart paper is applied one-to-one according to setting scale value (High/Low-limit scale value). (Ex: in case of -1 to 10V input type, to process from 0 to 5V input, set low-limit input value:0, high-limit input value:5.)

(8) Low-limit scale display value [CH□ Lo Scale]

In case of analog input type, this function is to set low-limit scale value for assigned low-limit input value.

- Set range: Within F.S. range(-1999 to 9999/-199.9 to 999.9/-19.99 to 99.99/-1.999 to 9.999)
- Factory default: 0.0(unit: Digit)

(9) High-limit scale display value CH□ Hi Scale]

In case of analog input type, this function is to set high-limit scale value for assigned high limit input value.

If assigned high/low-limit input value is 0V to 5V and user needs -100 to 100 value, user must set low-limit scale value : -100, high limit scale value : 100. When input value is 0V, PV displays -100. If input value is 5V, PV displays 100.)

- Set range: Within F.S. range(-1999 to 9999/-199.9 to 999.9/-19.99 to 99.99/-1.999 to 9.999)
- Factory default: 100.0 (unit: Digit)

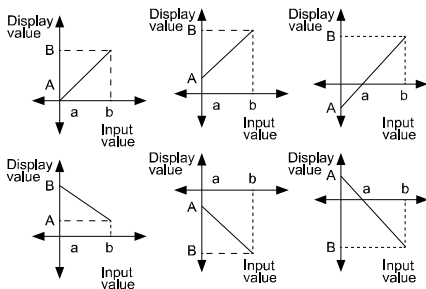
**Note**

Display scale function is able to change display value for max./min. measured input by setting high-limit scale [Hi Scale] and low-limit scale [Lo Scale].

High-limit scale value and Low-limit scale value setting (in case of input range 0-10V)

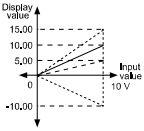
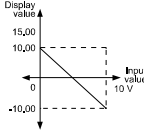
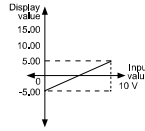
Lo Scale = 0.00 Hi Scale = 5.00, 10.00, 15.00, -10.00	Lo Scale = 10.00 Hi Scale = -10.00	Lo Scale = -5.00 Hi Scale = 5.00
		

When changing input type, high/low scale is changed as factory default.

(10) Scale dot position [CH□ Sc Point]

It is able to change decimal point position for high/low-limit scale value. It changes decimal point position of display value (PV and SV, etc).

- Set range: 0 / 0.0 / 0.00 / 0.000
- Factory default: 0.0(unit: -)



Note

In case of analog input and changing input type[CH□ In Type], scale value will be initialized to factory default.

If scale value for analog input is changed when input type [CH□ In Type] setup, previous record backup data is removed (Backup data time initialization) and start saving the data from the current modified time. Therefore please be careful for setup.

(11) Record display unit [CH□ Dp Unit]

This function is to set the unit for record and display.

If only input type parameter[CH□ In Type] is analog input, it is indicated.

In case of analog input unit setup, it is different with temp. sensor therefore PV conversion according to unit conversion is not operated.

In case of temp. sensor input model, it is related with temp. unit setup function therefore this parameter [CH□ DP Unit] is not indicated.

us0 to us9 is used to apply user font unit with 16X16 size(32byte) font.

User font unit is written through RS485 communication.

(Communication program, DAQMaster, has user unit setup and download function.)

- Set range:

Display unit	°C	°F	%	ppm	V	mV	mA	Pa	kPa	pH
Parameter	°C	°F	%	ppm	V	mV	mA	Pa	kPa	pH

Display unit	psi	kgf/cm ²	m ³ /h	mmHg	mmH ₂ O	us0 to us9	Not indicated
Parameter	psi	kgf	m/h	mmHg	mmH ₂ O	using with adding user unit	OFF

- Factory default: % (unit: -)

Input Type Setup
Alarm Setup
Reservation Setup

↓ MODE key

Low scale setup

CH1 Hi Range	:10.00
CH1 Lo Scale	:000.0
CH1 Hi Scale	:100.0

↑ Setting range : -1999 to 9999
↔ key
↓ (Increasing/Decreasing value)

← key (Moving the position of number)

High scale setup

CH1 Hi Range	:10.00
CH1 Lo Scale	:000.0
CH1 Hi Scale	:100.0

↑ Setting range : -1999 to 9999
↔ key
↓ (Increasing/Decreasing value)

← key (Moving the position of number)

Scale point setup

CH1 Sc Point	:0.0
CH1 Dp Unit	:000.0
CH1 In Bias	:100.0

↑ Setting range : 0↔0.0↔0.00
↔0.000
↔ key
↓ (Increasing/Decreasing value)

Display unit setup

CH1 Sc Point	:0.0
CH1 Dp Unit	:t
CH1 In Bias	:000.0

↑ °C↔°F↔%↔ppm↔V↔mV
↔mA↔Pa↔kPa↔pH↔ ...
↔ key
↓ (Unit conversion)



Note

When record backup if using total 10 user font units (us0 to us9), recent user font unit is dicated. For example, if previous us0 was # and changed to \$ recently, when data output by record backup, previous data with # unit also records with recent unit \$. Therefore one user font unit (us0 to us9) should be used for several units.

(12) Input correction [CH□ In Bias]

This function is to compensate an accidental error occurring by TC, RTD or analog input excluding product allowable error.

If sensor is not able to connect with the position of additional measuring object, this function is to be compensated through calculation of the temperature deviation value between the temperature of sensor connected position and the measuring object temp.

If applying input correction after measuring accidental error value for each sensor, it is able to measure temperature more precisely.

When using input bias function, accidental error value should be measured and if measured accidental error value is not precise, it will be larger.

Each channel is able to set for input bias. (CH1 In Bias, CH2 In Bias)
In case of TC or RTD, if temp. unit conversion °C ↔ °F or input type change, correction value will be initialized to 0. If actual temperature is 80°C, but display indicates 78°C, input correction value [CH□ Input Bias] should be set '2' for indicating 80°C.



↓ MODE key

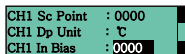

↑ Setting range : -999 to 999
⊞ ⊞ key
↓ (Increasing/Decreasing value)

⊞ key (Moving the position of number)

- Set range: -999 to 999
In case of TC or RTD input, correction value range is as follows
Temperature sensor range: (-200 to 1350), In Bias: -999 to 999
Temperature sensor range: (-199.9 to 999.9),
In Bias: -99.9 to 99.9
In case of analog input, bias value according to the decimal point of scale point is as following:
Sc Point: 0 In Bias: -999 to 999
Sc Point: 0.0 In Bias: -99.9 to 99.9
Sc Point: 0.00 In Bias: -9.99 to 9.99
Sc Point: 0.000 In Bias: -0.999 to 0.999
- Factory default: 0000 (unit: Digit)

(13) Channel name [CH□ Tag Name]

This function is to set tag name for each channel when recording. However LCD display channel name is fixed to CH1, CH2.

It is to set for each digit (4digit) in setting range and selected English is always capital letters.



↓ MODE key

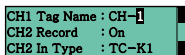

↑ =↔(Blank)↔ . ↔-1↔ -
 ⊗ ⊗ key
 ↓ (Increasing/Decreasing)

⊗ key (Moving the position of character)

- Set range: = ↔ (Blank) ↔ . ↔ -1 ↔ - ↔ 0 ↔ 1 ↔ 2 ↔ 3 ↔ 4 ↔ 5 ↔ 6 ↔ 7 ↔ 8 ↔ 9 ↔ A ↔ B ↔ C ↔ D ↔ E ↔ F ↔ G ↔ H ↔ I ↔ J ↔ K ↔ L ↔ M ↔ N ↔ O ↔ P ↔ Q ↔ R ↔ S ↔ T ↔ U ↔ V ↔ W ↔ X ↔ Y ↔ Z ↔ =
- Factory default: CH-□ (unit: -)

8.2.2 Alarm function setup

(1) Alarm output [Alarm Setup]

Alarm output operates when temp. or scale value of object for control is much higher or lower.



When each channel alarm output operation, relevant alarm indicating lamp(CH1=AL1, AL2 CH2=AL1, AL2) on display is lighting.

During recording, when alarm operation, current time, PV, alarm information (AL HI = \uparrow , AL LO = \downarrow , SBA = B, P.END = P) print to chart paper.

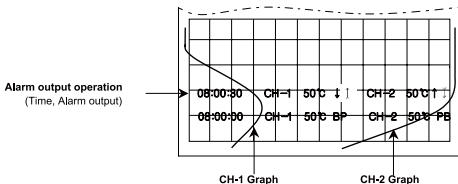
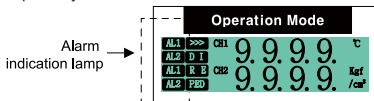
HI, LO of AL1, AL2 in printed AL1(\uparrow \downarrow)AL2(\uparrow \downarrow) for classify AL1 and AL2 separately.

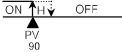
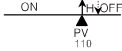

(2) Alarm output operation mode [CH□AL□Type]

Mode	Operation	Descriptions
Off	—	■None
PV.Hi	 <p>High-limit alarm temp (AL1.H): 90</p>  <p>High-limit alarm temp (AL1.H):110</p>	<p>■High-limit alarm PV ≥ high limit alarm temperature(AL1.H) , alarm output is ON. Recording mark: AL1=↑ AL2=↑</p>
PV.Lo	 <p>Low-limit alarm temp (AL1.L): 90</p>  <p>Low-limit alarm temp (AL1.L):110</p>	<p>■Low-limit alarm PV ≤ low-limit alarm temperature (AL1.L) , alarm is ON. Recording mark: AL1=↓ AL2=↓</p>
SBA	When sensor break is detected, ON	<p>■ Sensor Break Alarm When input is not connected or disconnected during recording, alarm output is ON. You can check the input break using external alarm output contact by buzzer or others. Recording mark: AL1= B AL2= B</p>
P.End	When chart paper is exhausted, ON	<p>■Paper end alarm If running out of recording paper during recording, alarm output is ON. (measured value is saved at system memory) When recording paper is replaced, alarm is cleared automatically (standard alarm) and P is printed on recording paper when printing back up data. Recording mark: AL1= P AL2= P</p>



- Factory default: CH□AL1 Type(PV.Hi), CH□AL2 Type(PV.Lo)

(3) Alarm output option [CH□AL□Opt]

When CH□AL□ Type changes to OFF mode, occurring alarms turns OFF.

Mode	Name	Operation description
None	Standard alarm	If it is an alarm condition, alarm output is ON. Unless an alarm condition, alarm output is OFF.
Latch	Alarm latch ^{※1}	If it is an alarm condition, alarm output is ON. An ON condition is latched. (Holding the alarm output)
StBy ^{※3}	Standby sequence ^{※2}	First alarm condition is ignored. From the second alarm condition, standard alarm operates. When power is ON and it is not an alarm condition, standard alarm operates.
La+St ^{※3}	Alarm latch and standby sequence	If it is an alarm condition, it operates both alarm latch and standby sequence. When power is ON and it is an alarm condition, it is ignored. From the second alarm condition, alarm latch operates.

● Factory default: None (unit: -)

- ※1. If user needs to cancel alarm latch function when current PV is out of the alarm range and when returning from sensor break alarm (SBA) or paper end alarm (P.End), please press + keys for over 3 sec. When PV is higher than alarm value after alarm operation on the status of alarm latch, if alarm mode changes to Standby sequence function or Latch + Standby sequence function, alarm will be OFF.
- ※2. Standby sequence function is applied again if power on or alarm value change.
- ※3. If alarm output operation mode [CH□AL□ Type] is SBA or P.End, it will be not applied and not indicated.

(4) Sensor break alarm [SBA]

If temp. sensor(TC, RTD) is not connected or it is disconnected during temp. control, alarm output will be ON.

Sensor break is able to be checked through buzzer or other devices by means of external alarm contact.

If alarm output operation mode sets to SBA, sensor break alarm will be operated.

※10V input is not applied for SBA.

(5) Paper end alarm [P.End]

During recording, if chart paper is exhausted, recording operation will be stopped and alarm output will be ON.

When chart paper is replaced, alarm will be off automatically. (In case of standard alarm)

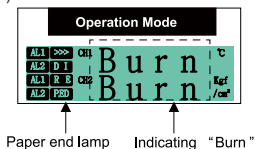
**(6) Alarm temperature [CH□ AL□ Lo], [CH□ AL□ Hi]**

When alarm setting value setup according to relevant alarm output operation mode, alarm output will be operated. According to selection of alarm output operation mode [CH□ AL□ Type], relevant channel parameter [CH□ AL□ Lo], [CH□ AL□ Hi] is interlocked and displayed. When selecting high-limit alarm mode [PV.Hi], only [CH□ AL□ High] is displayed.

When selecting low-limit alarm mode [PV.Lo], only [CH□ AL□ Low] is displayed.

If input type setup [CH□ In Type] is changed, [CH□ AL□ High] or [CH□ AL□ Low] value is changed to input range of input type setup [CH□ In Type] automatically.

If input type is TC or RTD and alarm temp. setup is selected to [CH□ AL□ Low], when burn operate by sensor open, alarm operation will be on.

- Set range: Within using/display range by input type
- Factory default: [CH□ AL□ Lo]: Low-limit scale value
- [CH□ AL□ Hi]: High-limit scale value (unit: °C/°F)

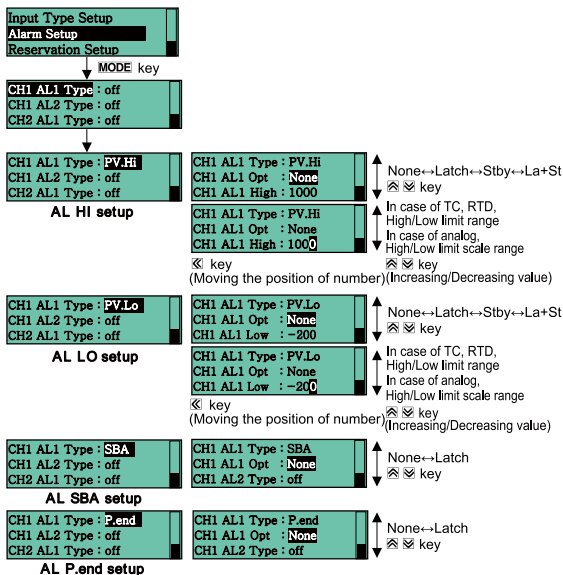

(7) Alarm output hysteresis [CH□ Alarm Hys]

As alarm output hysteresis, 'hysteresis' sets the interval between ON and OFF of alarm output.

- Set range: 001 to 999 (decimal point is placed same as input decimal point)
- Factory default: 001 (unit: Digit)

(8) High-limit alarm [PV.Hi]

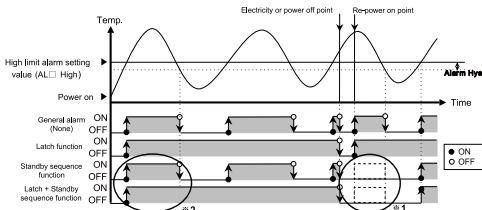

(9) Low-limit alarm [PV.Lo]

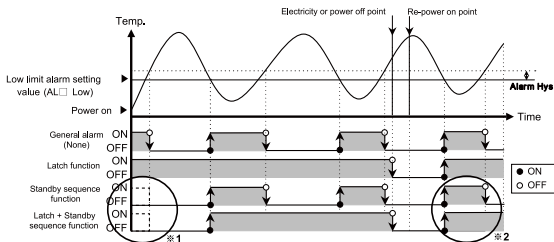

※ Standby sequence function

If only alarm output starts within relevant alarm condition range setting PV of the point of time of power on, the first alarm output does not operate and the second alarm output starts operating. (Refer to ※1)

However if alarm output starts out of relevant alarm condition range setting PV of the point of time of power on, the first alarm output starts operating same as general alarm. (Refer to ※2)

Application condition: When power on or changing alarm value, alarm output operation mode, alarm option.

※ Alarm latch function

Once alarm output is on, it will hold on even out of alarm output range. (Alarm output hold)

Cancellation condition: If need to cancel alarm latch function, please press $\text{[F]} + \text{[M]}$ key for over 3 sec. after current PV is lower than alarm value.

If need to cancel alarm latch function by sensor break alarm(SBA) and paper end(P.End), please press $\text{[} \text{+} \text{]}$ key for over 3 sec. after returning from SBA and P.End.

- ※ When changing alarm output operation mode. If alarm setting mode [CH□ AL□Type] is changed, alarm setting value [CH□ AL□High, Low] automatically is initialized to maximum value and minimum value.
- ※ When changing alarm output option, alarm setting value holds as previously.



Ex.

- Thermocouple Input

For setting mode of channel 1, Input type : TC-K1(-200 to 1350°C), Hi/Lo graph range : 0 to 1000°C. and channel 2 : 'Record off'. For alarm function of channel 1, AL1 low-limit: 100°C, Alarm option : None / AL2 high-limit : 600°C, Alarm option : None. For record mode, Record mode : graph mode, Recording speed : 960mm/h, Memo period : 1min. If setup is as above, recording will be as follows.

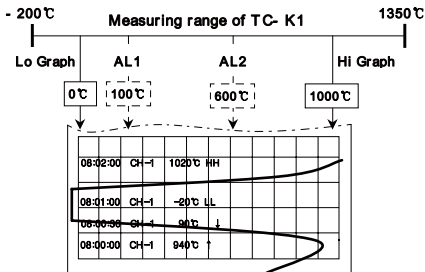

- i. Enter into setting mode
If pressing **MODE** key for 3 sec, it enters into setting mode from operating mode.
- ii. Input type setup
Enter into the lower menu from input type setup, the upper menu, by pressing **MODE** key. If pressing **MODE** key after moving to the lower menu of CH2 record, it enters into the setting category then set to 'Off' and press **MODE** key to get out of this menu. Also after moving to the lower menu of CH1 input type and entering into the setting category, set to 'TC-K1' and press **MODE** key to get out of this menu.

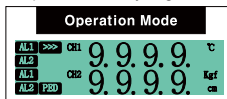

MODE key for 3 sec



- iii. Input High/Low graph range setup
Set CH1 Lo Graph:0, CH1 Hi Graph:1000 at the lower menu of input type setup.

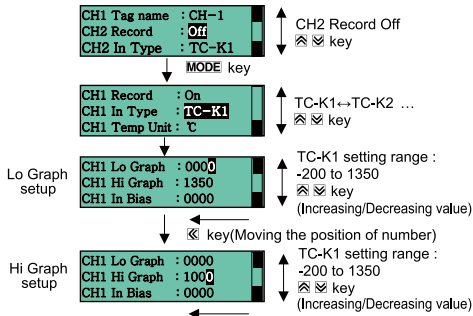

iv. Alarm setup

After moving to the upper menu from the lower menu of input type setup and selecting alarm setup, press **MODE** key to entering into the lower menu.

- v. After setting AL1 type : PV.Hi and saving it by pressing **MODE** key, set AL1 Opt : None, AL1 High : 600.
- vi. After setting AL2 type : PV.Lo and saving it by pressing **MODE** key, set AL2 Opt : None, AL2 Low : 100.

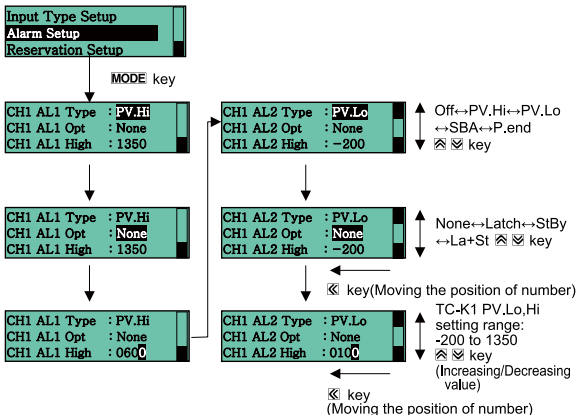

- vii. After moving to the upper menu from the lower menu of alarm setup and selecting record setup, press **MODE** key to entering into the lower menu.
- viii. Set Record mode : Graph, Rec speed : 960mm/h, Memo period : 1min.
- ix. After completing all setup, if pressing **MODE** key for 3 sec, it moves to operating mode and processes as above setting value.

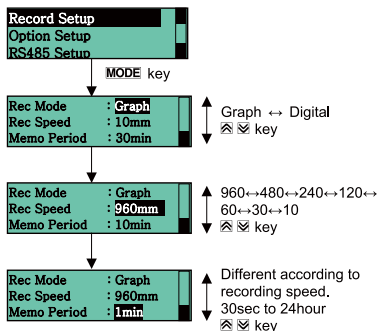

- 4 to 20mA input and unit

For setting mode of channel 2, Input type: 4 to 20mA type, Lo, Hi scale: 0.0 to 100.0, Dp unit: ppm. and channel 1: 'Record off'.

For alarm function of channel 2, AL1 High-limit: 70.0ppm, Alarm option: None / AL2 Low-limit: 20.0ppm, Alarm option: None.

For record mode, Record mode: graph mode, Recording speed: 960mm/h, Memo period: 1min. (Record mode setup is same as Example 1) If setup is as above, recording will be as follows.

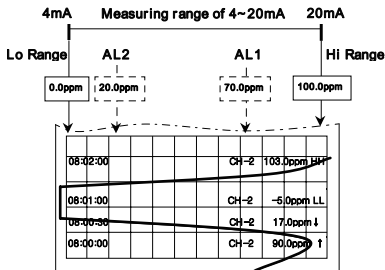

- i. Enter into setting mode
If pressing **MODE** key for 3 sec, it enters into setting mode from operating mode.

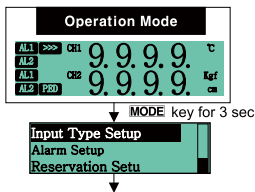

- ii. Input type setup
Enter into the lower menu from input type setup, the upper menu, by pressing **MODE** key. If pressing **MODE** key after moving to the lower menu of CH1 record, it enters into the setting category then set to 'Off' and press **MODE** key to get out of this menu. Also after moving to the lower menu of CH2 input type and entering into the setting category, set to '4 to 20mA' and set CH2 Dp unit to 'ppm' and press **MODE** key to get out of this menu.
- iii. Input High/Low scale setup
Set CH2 Lo Scale:000.0, CH2 Hi Scale:100.0 at the lower menu of input type setup.

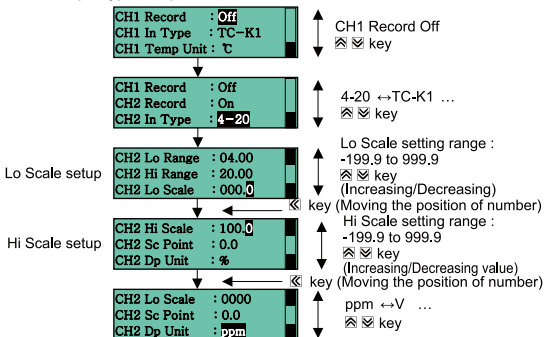

iv. Alarm setup

After moving to the upper menu from the lower menu of input type setup and selecting alarm setup, press **MODE** key to entering into the lower menu.

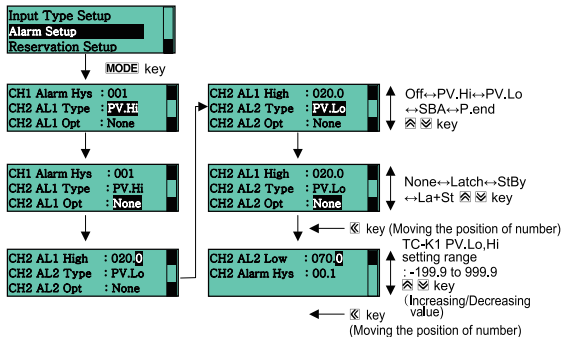
v. After setting CH2 AL1 type : PV.Hi and saving it by pressing **MODE** key, set AL1 Opt : None, AL1 High : 20.0.vi. After setting CH2 AL2 type : PV.Lo and saving it by pressing **MODE** key, set AL2 Opt : None, AL2 Low : 70.0.

8.2.3 Recording setup

(1) Recording run/stop

Once record starts, current PV is printing to chart paper according to setting list print, record mode, speed, language parameter setup.

If pressing  key for over 3 sec, it operates 'Recording Run or Stop' at the basis of current recording state.

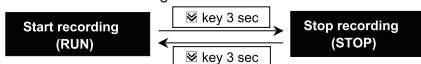

If DI-1 [Digital input 1] parameter sets "Run", it operates "Recording Short / Open" by means of external DI-1 terminals (No.16, 18).

※If using DI-1, front key for recording run/stop does not operate.

When RUN, ">>>" lamp is lightening. When STOP, "■" lamp is lightening. Once power ON, recording is able to Run or Stop automatically when re-power ON after electricity failure or by user according to recording run/stop parameter (PWR On State).

(2) Manual paper feeding

If pressing \llcorner key for over 3 sec at STOP state, chart paper is manually able to feed as fixed length (Approx. 10mm). If pressing \llcorner key continuously, chart paper is able to feed as fixed length every 3 sec.

The latest record is placed behind of paper cutter at STOP state therefore cut the chart paper after manual paper feeding in order to check the latest record.

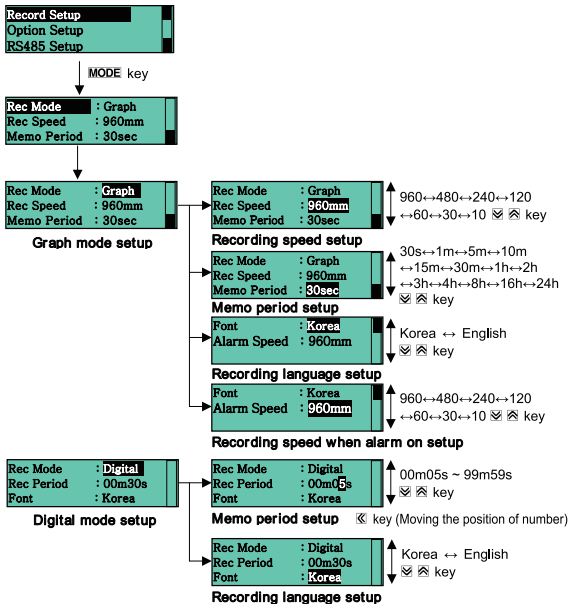

(3) Recording mode

This is to select the recording type to chart paper (Graph mode / Digital mode).

- Set range: Graph / Digital
- Factory default: Graph (unit: -)

(4) Graph mode

This mode is to record PV on chart paper by curved line graph.

Current date(Year-Month-Day) and high/low-limit scale value for relevant channels are recording every 1 hour.

Current time(hh:mm:ss) and PV for relevant channels are recording according to digital memo period [Memo Period] setup.

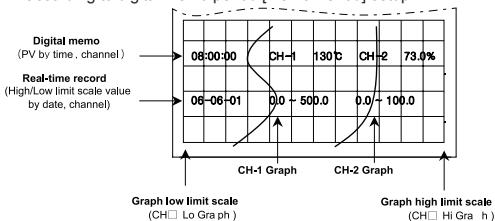

(5) Recording speed (Rec Speed)

This function is to set recording speed and it is able to set by feeding length per hour. If only record mode [Record Mode] is graph mode[Graph], it is indicated.

- Set range: 10 / 30 / 60 / 120 / 240 / 480 / 960
- Factory default: 10 (unit: mm/h)

(6) Digital memo period (Memo Period)

Recording period for recording current time(hh:mm:ss) and PV for channel to chart paper is set by digital numeric on graph mode as above figure.

Digital memo period is printing at the basis of regular time.

- Set range: Digital memo period setting range is limited according to recording speed as following table.
- Factory default: 30 (unit: min)(O: enable to set, X: disable to set)

Record speed (mm/h)	Digital memo period						
	None	30 sec.	1 min.	5 min.	10 min.	15 min.	30 min.
10	OFF	X	X	X	X	X	O
30	OFF	X	X	X	O	O	O
60	OFF	X	X	O	O	O	O
120	OFF	X	X	O	O	O	O
240	OFF	X	O	O	O	O	O
480	OFF	X	O	O	O	O	O
960	OFF	O	O	O	O	O	O

Record speed (mm/h)	Digital memo period						
	1 hour	2 hour	3 hour	4 hour	8 hour	16 hour	24 hour
10	O	O	O	O	O	O	O
30	O	O	O	O	O	O	O
60	O	O	O	O	O	O	O
120	O	O	O	O	O	O	O
240	O	O	O	O	O	O	O
480	O	O	O	O	O	O	O
960	O	O	O	O	O	O	O

**Ex.**

If digital memo period is 60 min and recording start time is '09:20', the first digital memo time recording is not '10:20' but '10:00' at the basis of regular time.

Recording time- 10:00 → 11:00 → 12:00 → 13:00 → Until recording end

If digital memo period is 10 min and recording start time is '09:23', the first digital memo time recording is not '09:33' but '09:30' at the basis of regular time.

Recording time- 09:30 → 09:40 → 09:50 → 10:00 → Until recording end

If digital memo period is 15 min and recording start time is '09:34', the first digital memo time recording is not '09:49' but '09:45' at the basis of regular time.

Recording time - 09:45 → 10:00 → 10:15 → 10:30 → 10:45 → Until recording end)

(7) Recording speed for alarm

When alarm on or during alarm latch function, this function is to set recording speed and it is able to check the cause and details of alarm operation.

It is able to check the change rate of PV before and behind alarm in detail because standard recording speed is able to be set faster than before.

If changing recording speed, this parameter is automatically changed same as recording speed.

However digital memo period is same as setting memo period.

- Set range: 10/ 30 / 60 / 120 / 240 / 480 / 960
- Factory default: 10 (unit: mm)



Note

After recording speed is set differently when alarm on, when user does not realize the change of this parameter setting value, user is able to misunderstand therefore please be aware of this function when using it. Regarding saved data by record backup, if record mode setup function (Rec mode, Rec period, Alarm speed) is changed, previous record backup data is removed(Backup data time initialization) and start saving the data from the current modified time. Therefore please be careful for setup.



Ex.

Recording speed: 240mm/h, Memo period: 5 min. , Alarm Speed:960mm/h

In case that alarm does not operate, when recording during per 240mm/h, 5 min., alarm occurs, it records per 960mm/h, 5 min. When alarm occurs and memo period is faster than settable memo period, it changes to the fastest memo period of the enable-to-set among the record speed.

Recording speed: 960mm/h, Memo period: 30 sec.,Alarm Speed:120mm/h

In case that alarm does not operate, when recording during per 960mm/h,30 sec. alarm occurs, it records per 120mm/h, 5 min.

(8) Digital mode

This mode is to record PV on chart paper by numeric and current time, PV for relevant channel are periodically recorded by printing/recording period setup [Rec period].

Current time(Year-Month-Day) and high/low-limit scale value are recorded every 24 hour period on digital mode.

Current PV is recorded through digital memo function by means of front key(☞ key+3sec), DI input terminal(DI-2+1sec) or communication.

00:02:00	CH-1	110℃	CH-2	75.0%
00:03:00	CH-1	110℃	CH-2	75.0%
00:01:00	CH-1	150℃	CH-2	75.0%
09-03-20	0 ~	1000	0 ~	500
23:59:00	CH-1	150℃	CH-2	72.0%
23:58:00	CH-1	120℃	CH-2	70.0%
23:57:00	CH-1	80℃	CH-2	58.0%

(9) Recording/Printing period (Rec Period)

It is to set period(min, sec) recording current date(hh:mm:ss) and PV for relevant channel by digital numeric.

- Set range: 00m05s to 99m59s
- Factory default: 01m00s (unit: min. sec.)

(10) Recording language (Font)

This recorder is able to record in Korean and English and current date, high/low-limit scale value and parameter list are recorded by setting language.

- Set range: Korea / English
- Factory default: Korea (unit: -)

**Ex.**

Korea: 현재시간 2009년03월19일 12시30분00초

English: DATE 03-19-2009 12:30:00

(11) Reservation recording

After user sets reservation time in advance, recording RUN and STOP automatically according to reservation time setting.

If reservation record parameter is 'On', recording start time and stop time setup parameter is indicated and recording operates according to setting time.

If returning to operating mode after setting reservation function on the setting mode, recording is stopped and the reservation record lamp (RE) is lighting on display.

During reservation record, if re-power on due to electricity failure and the time of re-power on is within reserved time, recording continuously operates but if out of reserved time, recording is stopped.

If parameter sets to 'Off', record start time and stop time are not displayed.

- Set range: Off(not using reservation recording), On(using reservation recording)
- Factory default: Off



Note

While recording by reservation record setup, recording RUN/STOP function by key+3sec, DI-1 input terminal, communication does not operate however if not, recording RUN/STOP function by key+3sec, DI-1 input terminal, communication is able to operate.

Start time must not be same as stop time and if setting it, "Time Set!!" message will be indicated on display.



Ex.

Record Setup Record Mode: Digital

Record Speed: 5sec

Reservation Setup Start Time: 12:00

Stop Time: 12:02

(Record Start)12:00:00→12:00:05...12:01:55→12:02:00(Record Stop)

(12) Recording start time (Start Time)

Set the recording start time.

- Set range: 00:00 to 23:59

(13) Recording stop time (Stop Time)

Set the recording stop time

- Set range: 00:00 to 23:59

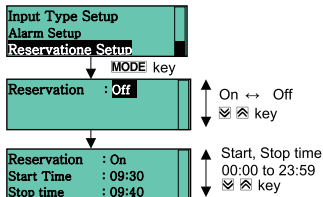

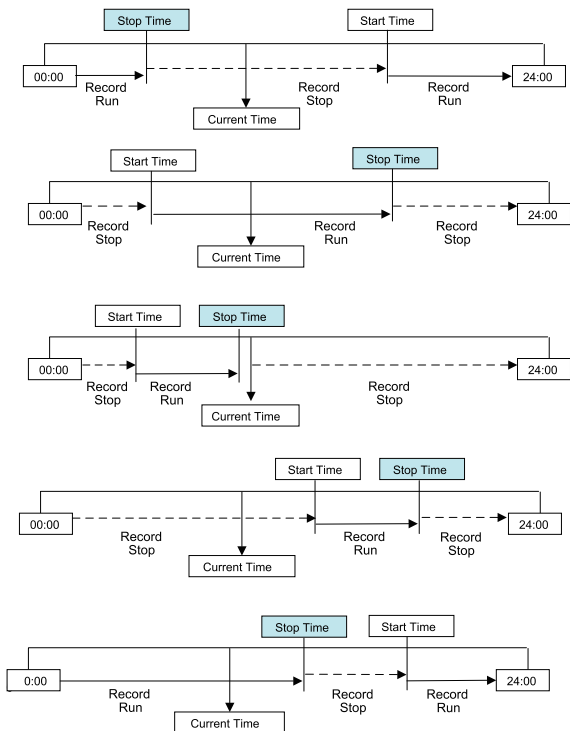

(14) DI-1 function [Digital Input 1]

This function is able to operate recording start by means of external digital input terminals (No.16, 18).

If this mode sets 'Run', recording operates by recording period setup while external digital input terminal is short.

When DI-1 function operates at the first time, recording after current time print as follows.

Korean: 현재시간 2009년03월19일 12시30분00초

English: DATE 03-19-2009 12:30:00

If this mode sets 'Off', no function operation.

- Set range: Off / Run
- Factory default: Off (unit: -)

**Note**

If using DI-1, front key for recording run/stop does not operate.

While recording by reservation record, DI-1 function is not able to operate and after reservation record stop, this function is able to operate.

(15) DI-2 function [Digital Input 2]

This function is able to operate recording start by means of external digital input terminals (No.17, 18). If this mode sets 'Memo', current time(hh:mm:ss) and PV for relevant channel are recorded at the time of inputting one signal to external digital input terminal.

It is able to operate with Memo function by means of  key+3sec together. If this mode sets 'Off', no function operates.

- Set range: Off / Memo
- Factory default: Off (unit: -)

**Note**

If applying voltage to terminal no.16 and 17, it may cause damage to input circuit or malfunction.

In case of no relay contact, it needs to use NPN open collector output type contact and in case of relay contact, it needs to use contact small current(0.2mA) is able to be flowed enough.

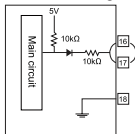

(16) Recording start/stop when power on [PWR On State]

This function is to set operating record when power on simultaneously. It is divided into Run and Stop.

If setting reservation record, the time of power on is reservation record start time but if not, record stop will hold.

- Set range: Run / Stop
- Factory default: Run (unit: -)

(17) Printing the setting list when record start [RUN On State]

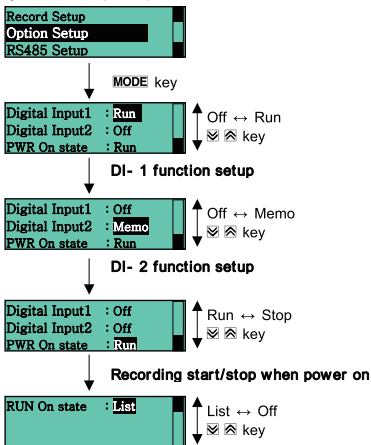

This function is to set printing the setting list when record start simultaneously. It is divided into List and Off.

- Set range: List / Off
- Factory default: Off(unit: -)



Printing the setting list when record start

(18) Digital memo

If pressing  key for 3 sec during record, current time(hh:mm:ss) and PV for relevant channel are recording by digital numeric to chart paper. (Digital input 2 function is also as memo function, if digital input 2 function is setting on, memo function is able to be used by front key.) - As memo function is only for one input, after pressing  key for 3 sec, memo function operates. In order to operate memo function again, this function must be off and on by  key again.

Digital memo function is able to operate by means of external DI-2 input terminal (No.17, 18).

If input has error 'HHHH', 'LLLL', 'BURN' at the time of operating digital memo, each relevant channel records 'HHHH', 'LLLL', 'BURN'.

(19) Paper end

If chart paper is exhausted during record, recording operation will be stopped and paper end lamp (P.ED) will lighten.

If alarm mode sets to paper end function, P.ED lamp will lighten and alarm output will be on simultaneously.

When changing chart paper, if sensing chart paper, the unrecorded data of since the time of exhausting chart paper is able to be recorded and printed.

(20) Data save, re-recording when chart is exhausted

This function is to record the data of after the time of exhausting chart paper if paper end function operates during run or stop.

It is similar with data logger and recording data is able to be saved in the internal memory of the recorder.

When changing chart paper, the following message is automatically indicated. Then user is able to select by , key whether recording the unrecorded data or not.

Record previous data in memory ? All Part Cancel

It records by current setting record mode (Digital mode or Graph mode). Therefore user is not able to change record setup of setting mode on P.END state.

All	Recording/Printing all data saved in memory of from the time of paper end to current time.
Part	Recording/Printing some parts of data saved in memory of from the time of paper end after user sets recording/printing time range (Start time/Stop time).
Cancel	Not recording/printing data in memory and return to operating mode.

- Set range: All / Part / Cancel (unit: -)
- Factory default: Cancel

If chart paper is exhausted during RUN state, it will be changed to STOP state automatically.

When user changes chart paper, message for re-recording function about unrecorded data is indicated on display and user is able to select the recording range.

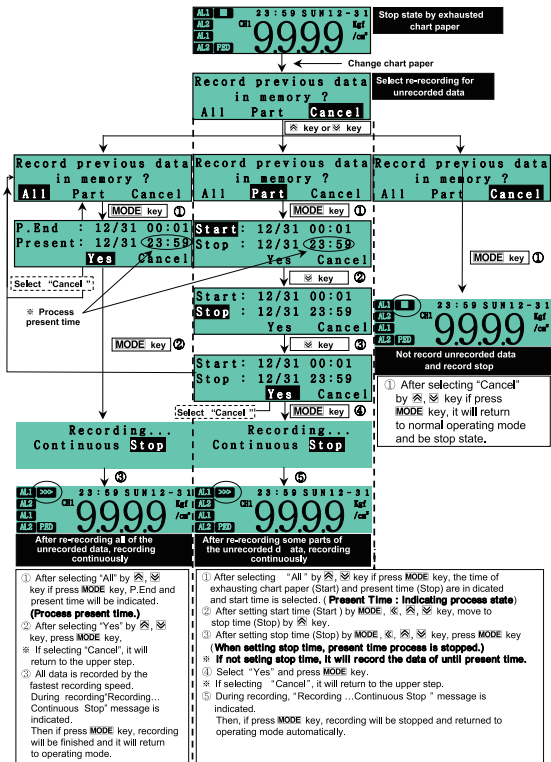

(21) Backup data recording [Rec Backup]

This function is similar to data logger and data is able to be saved in internal memory of recorder.

It is able to print selected all or part of data saved in fixed memory capacity at once. When entering into the setting mode, saving time as start time and stop time is indicated as following figure. Start time means backup start time and stop time means saving time of until present time.

```
Start: 03/09 12:01
Stop : 03/09 12:10
Gra h Di ital Cancel
```

Start time and stop time are fixed to be indicated for selecting favorable time period by user within saved time period on display for backup data saving time as above.

Stop time is fixed to be indicated but saving time continuously updates in recorder.

Therefore if user would like to print backup data after long time standby, printing it after setting to present time for stop time or printing with indicating it on display after cancel and entering into the setting mode again as following figure.

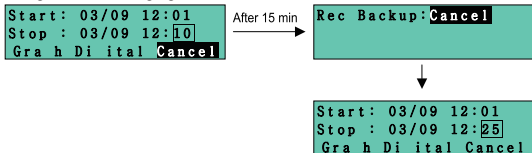

As data saving capacity of this recorder is 18138 ea, saving period is mentioned as next page according to recording mode.

Backup data record applies graph and digital mode. However if backup data is printed by different recording mode from saved recording mode (for example, data is saved by digital mode but printing data by graph mode), print by voluntary recording time (in case of digital mode) or period (in case of graph mode).

If backup data is saved by digital mode, the interval of saving backup data is different according to recording time. (for example, recording time of digital mode is set to 5 min., the interval of saving backup data is every 5 min. and stop time is changed every 5 min. as well.)

If total record saving time is not passed as figure on the next page, start time is fixed but stop time is updated. However if total record saving time is passed, both start time and stop time are updated since then. If graph mode, 960mm/h, total saving period is approx. 1 hour 30 min.

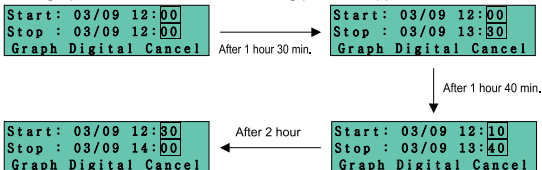

When data print by record backup, reading PV function is only able to be used among communication functions.

When changing setup as following, previous backup data is removed and it starts saving since this time.

Therefore please be careful when setup influenced to record backup data.

Record mode setup: When changing Rec mode, Rec period or Time, Alarm speed setting.

Input type setup: CH1 or 2 Record, CH1 or 2 In type,

When analog input, CH1 or when changing 2 Lo,Hi scale setting

Date/ Time setup: When changing date or time setting

- Set range: Cancel / Yes (unit: -)
- Factory default: Cancel

Graph Mod Rec Speed	Interval of saving time for 1 data	Total record backup time	
		2 CH mode	1 CH mode
960mm/h	0.5 sec.	11542x0.5 sec. = Approx. 1 hours 30 min.	18138x0.5 sec.= Approx. 2 hours 30 min.
480mm/h	1 sec.	Approx. 3 hours	Approx. 5 hours
240mm/h	2 sec.	Approx. 6 hours	Approx. 10 hours
120mm/h	4 sec.	Approx. 12 hours	Approx. 20 hours
60mm/h	8 sec.	Approx. 24 hours	Approx. 40 hours
30mm/h	16 sec.	Approx. 48 hours	Approx. 80 hours
10mm/h	48 sec.	Approx. 6 days(153 hour)	Approx. 10 days (241 hours)
5 sec.	5 sec.	11542x5 sec. = Approx. 16 hours	18138x5 sec. = Approx. 25 hours
1 min.	60 sec.	Approx. 8 days	Approx. 12 days
to	to	to	to
60 min.	3600 sec.	Approx. 480 days	Approx. 755 days
to	to	to	to
99 min. 59 sec.	6000 sec.	Approx. 800 days	Approx. 1259 days

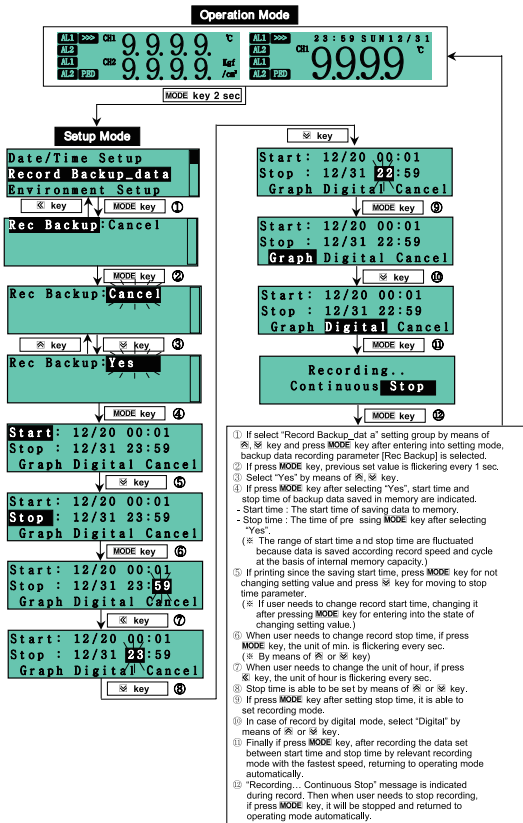

(22) Parameter setting list print

This function is to record setting information of main parameter.
During record, if pressing **☐** key for 3 sec., after recording setting information of each menu, recording PV again.

Record parameter: Tag name, Input, Unit, Range, Scale, Alarm mode, Alarm setting value, Communication function

When starting record, parameter setting information is able to be recorded according to printing the setting list parameter.

현재시간 09년03월10일 12시10분10초			DATE 09-10-2009 12:10:10		
※ 파라메타설정 ※			※ SETUP PARAMETER ※		
	채널 1	채널 2	CH 1	CH 2	
채널명칭	TEMP	HUMI	TAG NAME	TEMP	HUMI
입력사양	TC-K1	mA	INPUT	TC-K1	mA
표시단위	℃	%	UNIT	℃	%
입력범위	-200~1350	4~20	RANGE	-200~1350	4~20
기록범위	0~400	0~1000	SCALE	0~400	0~1000
경보1모드	HIGH	HIGH	ALARM 1	HIGH	HIGH
경보설정값	300	900	VALUE	300	900
경보2모드	LOW	LOW	ALARM 2	LOW	LOW
경보설정값	150	700	VALUE	150	700
통신기능	RS485	Modbus RTU	INTERFACE	RS485	Modbus RTU
소형기록계 KRN50 www.autonics.co.kr A/S : 032-329-5055			Recorder KRN50 www.autonics.co.kr A/S : 82-32-329-5055		

<Korean>

<English>

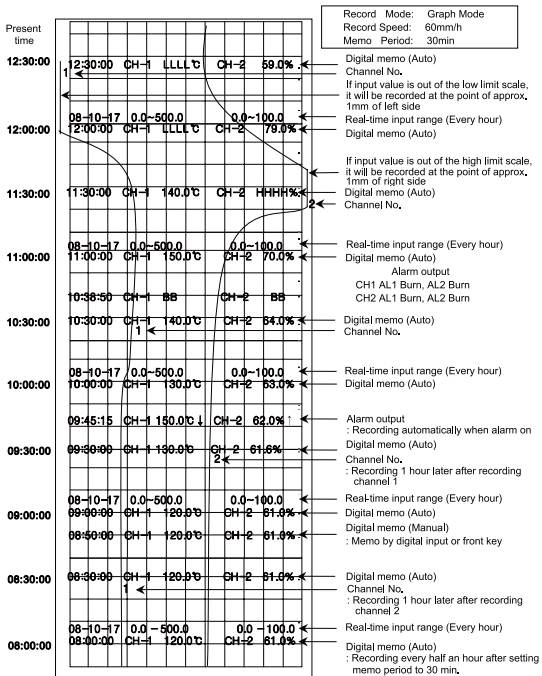

8.2.4 Display information function

(1) Error

This function is to indicate the message for error state.

Message	Descriptions
HHHH	<p>If input value is higher than the input range, it will flash every 0.5 sec. → When input value is within the input range, it will be automatically cancelled.</p> <p>In case of analog input: If full scale(F.S) of input range is within $\pm 10\%$, it will indicate PV only on LCD display and it will record PV with either HH or LL simultaneously as the (a) of following figure. If full scale(F.S) of input range is out of $\pm 10\%$, it will indicate and record HHHH, HH or LLLL, LL as the (b) of following figure. But in case of $H_i < L_o$ setting, it will be indicated oppositely. Therefore in case of 0 to 20mA input and H_i scale=0, L_o scale=100, then if input is out of 20mA, it will indicate LLLL, not HHHH. (In case of 1V analog input, HHHH, LLLL do not operate.) In case of TC, RTD input: After setting H_i, L_o Graph value within sensor temperature range, if PV is out of H_i, L_o Graph value, it will indicate PV only on LCD display and it will record PV with either HH or LL simultaneously as the (c) of following figure. After setting H_i, L_o Graph value same as sensor temperature range, if PV is out of temperature range, it will indicate and record HHHH or LLLL as the (d) of following figure.</p>
LLLL	<p>If input value is lower than the input range, it will flash every 0.5 sec. When input value is within the input range, it will be automatically cancelled.</p> <p>In case of analog or TC, RTD input, indicating will be same as above. (In case of 1V analog input, HHHH, LLLL do not operate.)</p>
BURN	<p>If input except for 10V input is disconnected, it will flash every 0.5 sec. → When input is connected normally, it will be automatically cancelled.</p>
Time Set!!	<p>If time setup is fault for re-recording function by record backup or P.end, it will be indicated. If start time and stop time are same on reservation record function, it will be indicated. If pressing MODE key, it will be cancelled and returned to previous setting state.</p>

Message	Descriptions
Over range!!	When setting HI,LO Graph or range on input type setup, if setting value is out of limit value, it will be indicated. If pressing MODE key, it will be cancelled and returned to previous setting state.
Hi < Lo!!	When setting HI,LO Graph or range on input type setup, if setting value is Hi < Lo or it is not accurate with setting range introducing in this user manual, it will be indicated.(Ex, In case of TC-K1 and -200 to 1350°C, high limit scale value setting range is low-limit scale value + F.S 10% to Max. input range for each sensor, -1350°C to -122.5°C. Then if setting -123°C, "Hi < Lo !!"error message will be indicated.) If pressing MODE key, it will be cancelled and returned to previous setting state.

Relevant channel occurs error operation as above, above message will be indicated by relevant channel turn.

HH or LL message will be indicated when alarm does not operate.

Figure a	→	08:15:00	CH-1	5V	HH	CH-2	5V	HH		
Figure b	→	08:25:00	CH-1	HHHH	℃	HH	CH-2	HHHH	℃	HH
Figure c	→	08:15:00	CH-1	170℃	LL	CH-2	170℃	LL		
Figure d	→	08:30:00	CH-1	LLLL	℃	LL	CH-2	LLLL	℃	LL

(2) Display indicating mode

In case of 2 channel model, display mode is divided by normal mode (2 channel mode or 1 channel autorotation) and manual mode.

(3) Display normal mode [Display Mode]

2 Channel mode [2CH]: As indicating input value (PV) of 2 channel (CH1 and CH2) simultaneously, if setting display mode to 2 CH on environment setup, PV of CH1 is indicated at the top and PV of CH2 is indicated at the bottom simultaneously.

1 Channel autorotation mode [1CH]: As indicating and rotating 1 channel by periods if setting display mode to 1 CH on environment setup, PV for each channel is automatically rotating and indicating by 2 sec. cycle. (Indicating CH1 for 2 sec. ↔ CH2 for 2 sec.)

If setting one channel record only [Input type setup group >> CH1 or CH2 Record 'Off'], 1 channel display mode is fixed and indicated.

- Set range: 2CH / 1CH (unit: -)
- Factory default: 2CH

(4) Display manual mode

User is able to select one channel manually by means of $\left[\text{CH} \right]$ or $\left[\text{KEY} \right]$ key. Display mode conversion method is as follows.

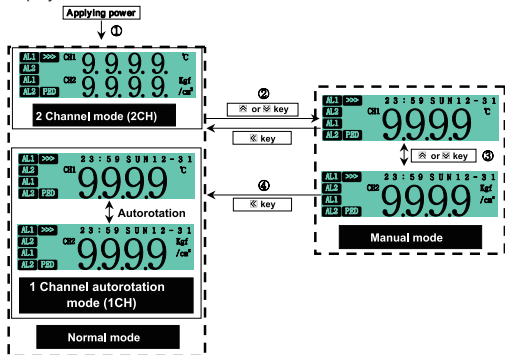

If applying power, it will be indicated by mode setup (2CH or 1CH) on display mode parameter.

When user needs to indicate 1 channel by manual mode, if pressing $\left[\text{CH} \right]$ or $\left[\text{KEY} \right]$ key, PV of CH1 will be indicated.

Each channel is able to be converted/selected by $\left[\text{CH} \right]$ or $\left[\text{KEY} \right]$ key. (CH1 ↔ CH2)

If pressing $\left[\text{KEY} \right]$ key on manual mode, it will be converted to normal mode. When applying power or when returning after an electricity failure, it will be indicated by mode setup (2CH or 1CH) on display mode parameter automatically.

(5) LCD backlight

This function is to set LCD backlight type and there are always lightening type and temporary lighting type.

Always lightening type [Always] : It will lighten up during power on.

Temporary lightening type [Temp] : It will lighten up for 30 sec. after power on and then automatically light down if no key input.

During light down state, if operating front key, it will lighten automatically.

If no key input for 30 sec after final front key operation, it will light down automatically.

(6) Parameter lock

This function is to restrict checking and changing parameter setting value.

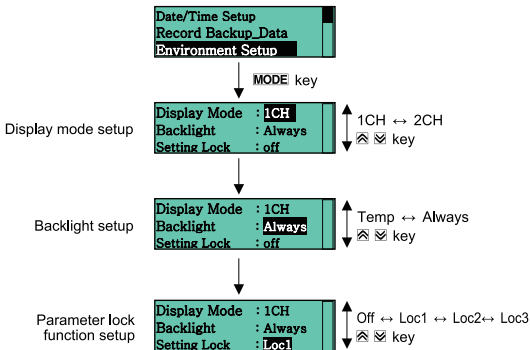

Parameter	OFF	Loc1	Loc2	Loc3
Alarm Setup	●	●	●	◐
Reservation Setup	●	●	◐	○
Input Setup				
Record Setup	●	●	◐	○
Option Setup				
RS485 Setup				
Date/Time Setup				
Record Backup_Data	●	◐	○	○
Environment Setup				

●: Enable to check/set, ◐: Enable to check, disable to set,

○: Disable to check

Even though selecting [Loc1],[Loc2],[Loc3], [Setting Lock] parameters will be always indicated and it will be changed.

● Factory default: Off (unit: -)

**Note**

Even though setting parameter lock function up, parameter will be initialized by parameter initializing function.

(7) Parameter initialization [Parameter Initialize]

This function is to initialize all parameters in memory to factory default value.



If select setting value to “Yes” by \triangle or \square key and press **MODE** key, all parameters will be initialized to factory default value and returned to operating mode. If pressing **MODE** + \square key for 5 sec. simultaneously, it will operate.

- Set range: Yes / No
- Factory default: No (unit: -)

9. Communication



This function is to set or monitor parameter by external upper system (PC, PLC, etc.) or transmit data to external equipment by communication.

KRN50 recorder is able to communicate through back terminal or front phone jack. (In case of back terminal connection.

Front and back communication functions are not used simultaneously. (use autonics SCM-US (sold separately) for communicating by front communication port.)

Interface

Application standard	Compliance with EIA RS485
Max. connections	31units(address: 01 to 99)
Communication method	2-wire Half duplex
Communication synchronous method	Asynchronous
Communication distance	Within max. 1 Km
Communication speed	1200, 2400, 4800, 9600, 19200, 38400, 57600 bps
Communication respond wait time	0.05 to 0.99sec
Start bit	1bit (fixed)
Stop bit	1 or 2bit
Parity bit	NONE, Odd, Even
Data bit	8bit (fixed)
Protocol	ModBus RTU

Communication setting of KRN50 should be same as upper system.
 Double setup of communication address at the same line is not allowed.
 In case of communication cable, twisted pair wire accurate for RS485 communication must be used.

When extending cables and using 1:N multi-drop, it may cause transmission error. Terminal resistor must be used to both end parts of network. (Terminal resistive value :100 to 120Ω, 1/4W)

Example for system formation

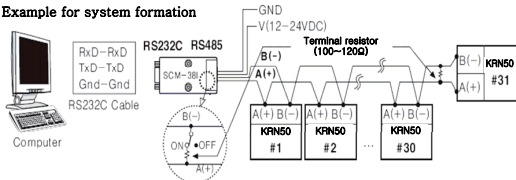

It is recommended to use Autonics communication converter SCM-381(RS232C to RS485 converter), SCM-US481(USB to RS485 converter).

It is recommended to use DAQMaster program for monitoring.
 You can download DAQMaster program and communication manual at our website (www.autonics.com).



Note

For non-communication function models (KRN50-1000-00, KRN50-1002-00, KRN50-2000-00, KRN50-2002-00, KRN50-2004-00), communication is available by front phone jack but there are no communication setup function. Communication setting is fixed as communication speed: 9600bps, communication respond waiting time: 0.05sec, Start bit: 1bit, Stop bit: 2bit, Parity bit=None.

9.1 ModBus address Map

(1) Alarm output setup group [Alarm Setup]

Parameter	Addr	Description	Set range	Unit	Default
CH1 AL1 Type	40101	CH1 alarm output1 operation	0: Off 1: PV.Hi 2: PV.Lo 3: SBA 4: P.End	—	PV.Hi
CH1 AL1 Opt	40102	CH1 alarm output1 option	0: None 1: Latch 2: StBy 3: La+St	—	None
CH1 AL1 Low ^{※1}	40103	CH1 alarm output1 low-limit SV	Display range by input type	Digit	-200
CH1 AL1 High ^{※1}	40104	CH1 alarm output1 high-limit SV			1350
CH1 AL2 Type	40105	CH1 alarm output2 operation	0: Off 1: PV.Hi 2: PV.Lo 3: SBA4: P.End	—	PV.Lo
CH1 AL2 Opt	40106	CH1 alarm output2 option	0: None 1: Latch 2: StBy 3: La+St	—	None
CH1 AL2 Low ^{※1}	40107	CH1 alarm output2 low-limit SV	Display range by input type	Digit	-200
CH1 AL2 High ^{※1}	40108	CH1 alarm output2 high-limit SV			1350
CH1 Alarm Hys	40109	CH1 alarm output hysteresis	001 to 999	Digit	001
CH2 AL1 Type ^{※2}	40110	CH2 alarm output1 operation	0: Off 1: PV.Hi 2: PV.Lo 3: SBA4: P.End	—	PV.Hi
CH2 AL1 Opt ^{※2}	40111	CH2 alarm output1 option	0: None 1: Latch 2: StBy 3: La+St	—	None
CH2 AL1 Low ^{※1 ※2}	40112	CH2 alarm output1 low-limit SV	Display range by input type	Digit	-200
CH2 AL1 High ^{※1 ※2}	40113	CH2 alarm output1 high-limit SV			1350
CH2 AL2 Type ^{※2}	40114	CH2 alarm output2 operation	0: Off 1: PV.Hi 2: PV.Lo 3: SBA4: P.End	—	PV.Lo
CH2 AL2 Opt ^{※2}	40115	CH2 alarm output2 option	0: None 1: Latch 2: StBy 3: La+St	—	None
CH2 AL2 Low ^{※1 ※2}	40116	CH2 alarm output2 low-limit SV	Display range by input type	Digit	-200
CH2 AL2 High ^{※1 ※2}	40117	CH2 alarm output2 high-limit SV			1350
CH2 Alarm Hys ^{※2}	40118	CH2 alarm output hysteresis	001 to 999	Digit	001

※It displays only for alarm output models.

※1: It is related with alarm output operation(AL□ Type) parameter setting.
CH□ AL□ Type(Off, SBA or P.end): CH□ AL□ Low, CH□ AL□ High parameters are not displayed.

CH□ AL□ Type(PV.Hi): CH□ AL□ High parameter is not displayed.

CH□ AL□ Type(PV.Lo): CH□ AL□ Low parameter is not displayed.

※2: It displays only for 2 channels alarm output model.

(2) Reservation record setup group [Reservation Setup]

Parameter	Addr	Description	Set range	Unit	Default
Reservation	40070	Reservation ON/OFF	0: OFF 1: ON	—	Off
Start Time ^{*1}	40071	Start record Hour	00:00 to 23:59	hh:mm	00:00
	40072	Start record Minute			
Stop Time ^{*1}	40073	End record Hour	00:00 to 23:59		00:01
	40074	End record Minute			

※1: This parameters are displayed only when reservation ON/OFF is 'On'.

(3) Input type setup group [Input Type Setup]

Parameter	Addr	Description	Set range	Unit	Default
CH1 Record	40301	CH1 using/recording	0: USE 1: NO USE	—	On
CH1 In Type	40302	CH 1 input type	0:TC-K1 1:TC-K2 2:TC-J1 3:TC-J2 4:TC-E1 5:TC-E2 6:TC-T1 7:TC-T2 8:TC-B 9:TC-R 10:TC-S 11:TC-N 12:TC-C 13:TC-G 14:TC-L1 15:TC-L2 16:TC-U1 17:TC-U2 18:TC-P 19:CU50 20:CU100 21:JPT1 22:JPT2 23:DPT50 24:DPT1 25:DPT2 26:A.mV1 27:A.mV2 28:A-V1 29:A-V2 30:A.mA1 31:A.mA2	—	TC.K1
CH1 Temp Unit ^{*1}	40303	CH 1 temp. unit	0: °C, 1: °F	—	°C
CH1 Lo Graph ^{*1}	40304	CH 1 graph low-limit scale value	※Refer to the 8.2.1 (4), (5)	Digit	-200
CH1 Hi Graph ^{*1}	40305	CH 1 graph high-limit scale value			1350
CH1 Lo Range ^{*2}	40306	CH 1 low-limit input value	※Refer to the 8.2.1 (6), (7)	—	—
CH1 Hi Range ^{*2}	40307	CH 1 high-limit input value			—
—	40308	—	—	—	—
CH1 Lo Scale ^{*2}	40309	CH 1 low-limit scale display value	-1999 to 9999	Digit	000.0
CH1 Hi Scale ^{*2}	40310	CH 1 high-limit scale display value			100.0
CH1 Hi Scale Decimal Point ^{*2}	40311	CH 1 scale dot position	0: 0 1: 0.0 2: 0.00 3: 0.000	—	0.0
CH1 DP Unit ^{*2}	40312	CH 1 record display unit	0:°C 1:°F 2:% 3:ppm 4:V 5:mV 6:mA 7:Pa 8:kPa 9:pH 10:psi 11:kgf/cm ² 12:m ³ /H 13:mmHg 14:mmH ₂ O 15:User1 16:User2 17:User3 18:User4 19:User5 20:User6 21:User7 22:User8 23:User9 24:User0 25:OFF	—	%

Parameter	Addr	Description	Set range	Unit	Default
CH1 In Bias	40313	CH 1 input correction	-999 to 999	Digit	000
CH1 Tag Name	40314	CH 1 channel name□□□□	front two characters, ex)C H - 1	—	CH
	40315		rear two characters, ex) C H - 1	—	-1
CH2 Record ^{※3}	40319	CH 2 using/recording	0: USE 1: NO USE	—	On
CH2 In Type ^{※3}	40320	CH 2 input type	same as addr. 40301 setting	—	TC.K1
CH2 Temp Unit ^{※3}	40321	CH 2 temp. unit	0:°C 1:°F	—	°C
CH2 Lo Graph ^{※3}	40322	CH 2 graph low-limit scale value	※Refer to the 8.2.1 (4), (5)	Digit	-200
CH2 Hi Graph ^{※3}	40323	CH 2 graph high-limit scale value			1350
CH2 Lo Range ^{※3}	40324	CH 2 low-limit input value	※Refer to the 8.2.1 (6), (7)	—	—
CH2 Hi Range ^{※3}	40325	CH 2 high-limit input value		—	—
—	40326	—	—	—	—
CH2 Lo Scale ^{※3}	40327	CH2 low-limit scale display value	-1999 to 9999	Digit	000.0
CH2 Hi Scale ^{※3}	40328	CH 2 high-limit scale display value			100.0
CH1 Hi Scale Decimal Point ^{※2}	40329	CH 1 scale dot position	0:0, 1:0.0, 2:0.00, 3:0.000	—	0.0
CH2 DP Unit ^{※3}	40330	CH 2 record display unit	Same as addr. 40311	—	%
CH2 In Bias ^{※3}	40331	CH 2 input correction	-999 to 999	Digit	000
CH2 Tag Name ^{※3}	40332 to 40333	CH 2 channel name	Same as addr. 40313 to 40314	—	CH-2

※1: Displays only when input type(In Type) is temperature sensor.

※2: Displays only when input type(In Type) is analog (voltage/current).

※3: Displays only for 2 channels model.

(4) Record mode setup group [Record Setup]

Parameter	Addr	Description	Set range	Unit	Default
Rec Mode	40080	Record mode	0: Graph 1: Digital	—	Graph
Rec Speed ^{※1}	40081	Record speed	0:10, 1:30, 2:60, 3:120,4:240 5:480,6:960	mm/hour	10mm
Memo Period ^{※1}	40082	Digital memo period	※Refer to the 8.2.3 (6)	min	30min
Rec Period ^{※2}	40083	Record cycle	※ Refer to the 8.2.3 (9)	m.s	01m00s
Rec Font	40084	Record font	0: Korea 1: English	—	Korea
Alarm Speed	40085	Record speed for alarm	0:10, 1:30, 2:60, 3:120,4:240 5:480,6:960	mm/hour	10mm

※1: Displays only when record mode (Rec Mode) is set as 'Graph'.

※2: Displays only when record mode (Rec Mode) is set as 'Digital'.

(5) Option setup group [Option Setup]

Parameter	Addr	Description	Set range	Unit	Default
Digital Input 1	11	DI-1 input terminal function	0: Stop 1: Run	—	Off
Digital Input 2	12	DI-2 input terminal function	0: Off 1: Memo	—	Off
PWR On State	2	Record run/stop when power is supplied	0: Run 1: Stop	—	Run
Run On State	3	Setting list printing during recording	0: Off 1: List	—	List

**(6) RS485 communication setup group [RS485 Setup]
(Read Only)**

Parameter	Addr	Description	Set range	Unit	Default
Address	40001	Communication address	01 to 99	—	01
Baud Rate	40002	Communication speed	0:1200 1:2400 2: 4800 3:9600 4:19200 5:38400 6:57600	bps	9600bps
Parity bit	40003	Parity bit	0:None 1:Odd 2: Even	—	None
Stop Bit	40004	Stop bit	0: 1 1: 2	Bit	2
Response Time	40005	Response time	50 to 990	msec	50
Com Write	40006	Communication write enable/disable	0: Enable 1: Disable	—	Enable

(7) Date/Time setup group [Date/Time Setup]

Parameter	Addr	Description	Set range/Unit	Default
Date	40052	Year	00 to 99	
	40053	Month	00 to 12	
	40054	Day	00 to 31	
Time	40055	Hour	00 to 23	
	40056	Minute	00 to 59	
	40057	Second	00 to 59	

(8) Environment setup group [Environment Setup]

Parameter	Addr	Description	Set range	Unit	Default
Display Mode	101	CH 1 display mode	0: Off 1: On	—	2CH
	102	CH 2 display mode	0: Off 1: On		
	103	Display standard mode ^{*1}	0: Displays 2 channels 1: Display per 1 channel in turn automatically		
Setting Lock	40066	Lock	0: Off 1: Loc1 2: Loc2 3: Loc3	—	Off
Backlight	40067	Backlight	0: Temp 1: Always	—	Temp

(9) Others

Address	Description		Set range			Default
1	Record run/stop (Recording RUN/STOP)		0:STOP 1: RUN			0
4	SV initialization (Parameter initialization) ※1		0:OFF 1:ON			0
5	Memo (Memo)		0:OFF 1:ON			0
41	Feed (Paper Feed)		0:STOP 1:FEED			0
52	List printing (Paper List Print)		0:STOP 1:PRINT			0
10001	Printing paper status(Paper Status)		0 : Paper 1 : Paper End			0
10101	CH1 AL1 Status		0 : CH1-AL1 off 1 : CH1-AL1 on			0
10102	CH1 AL2 Status		0 : CH1-AL2 off 1 : CH1-AL2 on			0
10103	CH2 AL1 Status		0 : CH2-AL1 off 1 : CH2-AL1 on			0
10104	CH2 AL2 Status		0 : CH2-AL2 off 1 : CH2-AL2 on			0
10301	Digital input 1 status(DI1-Status)		0: OFF 1: ON, operates only for ON			0
10302	Digital input 2 status (DI2-Status)		0: OFF 1: ON, operates only for ON			0
30001	CH1-display value(PV)					
30002	CH1	BIT position	Unit	Unit group	Status	Display value dot position
	Unit	15 to 10	※2	※2	00: NONE	00: 0
	Unit group	9 to 4			01: HHHH	01: 0.0
	Status	3 to 2			10: LLLL	10: 0.00
	Display value dot	1 to 0			11: BURN	11: 0.000
3003						
3004	CH1	BIT position	Unit	Unit group	Status	Display value dot position
	Unit	15 to 10	※2	※2	00: NONE	00: 0
	Unit group	9 to 4			01: HHHH	01: 0.0
	Status	3 to 2			10: LLLL	10: 0.00
	Display value dot	1 to 0			11: BURN	11: 0.000
30101	Serial No H					
30102	Serial No L					
30103	Software Version					
30104	Hardware Version					
30105	Model Name1		"KR"			
30106	Model Name2		"N5"			
30107	Model Name3		"0- "			
30108	Model Name4		"X0 " X : marked by the model			

Address	Description	Set range	Default
30109	Model Name5	"0X " X : marked by the model	
30110	Model Name6	" -X " X : marked by the model	
30111	Model Name7	"0 "	
30112	Model Name8	" "	
30113	Model Name9	" "	
30114	Model Name10	" "	
30118	Coil Start Address	1	
30119	Coil Quantity	12	
30120	Input Start Address	10001	
30121	Input Quantity	15	
30122	Holding REG Start Address	30001	
30123	Holding REG Quantity	26	
30124	Input REG Start Address	40001	
30125	Input REG Quantity	154	
42001 to 16	User unit font0 ※18.1	User0(16 x 16size)	
42017 to 32	User unit font1 ※18.1	User1(16 x 16size)	
42033 to 48	User unit font2 ※18.1	User2(16 x 16size)	
42049 to 64	User unit font3 ※18.1	User3(16 x 16size)	
42065 to 80	User unit font4 ※18.1	User4(16 x 16size)	
42081 to 96	User unit font5 ※18.1	User5(16 x 16size)	
42097 to 112	User unit font6 ※18.1	User6(16 x 16size)	
420113 to 128	User unit font7 ※18.1	User7(16 x 16size)	
420129 to 144	User unit font8 ※18.1	User8(16 x 16size)	
420145 to 160	User unit font9 ※18.1	User9(16 x 16size)	
50001 to 52048	User Logo ※18..2	384 x 80size	

※1: When initializing SV, SVs related communication are also initialized.

※2: Unit and Unit group values are used at user unit download function of the integrated device management program (DAQMaster).

10. DAQMaster

10.1 Overview

DAQMaster is a comprehensive device management program that can be used with Autonics thermometers, panel meters, pulse meters, counters, recorders, and indicators, etc.

DAQMaster provides GUI control for easy and convenient management of parameters and multiple device data monitoring.

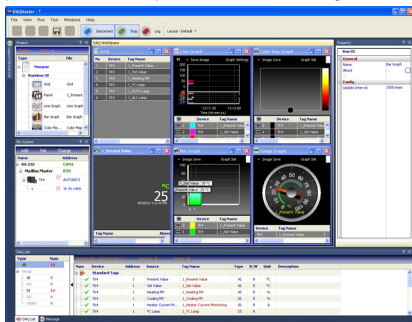

Note

You can download DAQMaster and the user manual of DAQMaster at Autonics homepage (www.autonics.com).

This user manual describes only KRN50 functions of DAQMaster. For more information about DAQMaster program, refer to the user manual of DAQMaster.

10.2 Features

DAQMaster has the following features:

- **Multiple Device Support**
 - Simultaneously monitor multiple devices and set parameters.
 - Simultaneously connect units with different addresses in a single device.
 - Multiple RS-232 ports are available for communications using Modbus remote terminal unit.
- **Device Scan**

In cases of multiple units (with different addresses) connected together, the unit scan function automatically searches for units.
- **Convenient User Interface**

Freely arrange windows for data monitoring, properties, and projects. Saving a project also saves the screen layout.
- **Project Management**

You can save added device information, data monitoring screen layouts, and I/O source selection as project files. Opens project files to load the saved settings.
Provides a project list for simple and easy project file management.
- **Monitoring Data Log**

When monitoring, data log files can be saved as either DAQMaster data files (.ddf) or CSV (.csv) files. Open files saved in .csv format directly from Microsoft Excel.
Define log data file naming/saving rules and destination folders to make file management convenient.
- **Data Analysis**

Performs grid and graph analyses of .ddf data files using DAQMaster's data analysis feature. Saves grid data as .rtf, .txt, .html, or .csv files in Data Grid.
- **Print Modbus Map Table Report**

Print address map reports of registered Modbus devices. Modbus map table reports can be saved as .html and .pdf formats.
- **Multilingual Support**

Supports Korean, English, Japanese, Simplified Chinese. To add a different language, modify the files in the Lang folder, rename, and save.
- **Script Support**

Uses the Lua Script language and deals with different I/O processes for individual devices.

10.3 Dedicated function for KRN50

The following are special features for KRN50 while in communication with DAQMaster.

(1) Accessing Record Backup Data

To get the recorded data, click '...' button located on the right of Record Backup in the Property window.

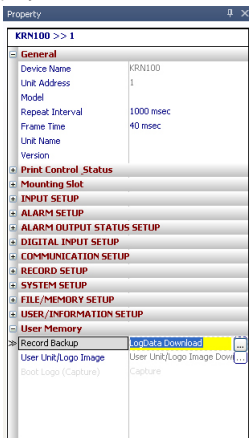

To read memory information, the device status must be Connected and not Run.

There are also cases in which you cannot read from memory depending on KRN50 parameter setting.

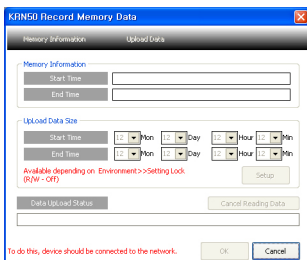

Once all conditions are met and ready to get memory data, follow the steps below:

- i. Run [Memory Information] in KRN50 Record Memory Data window. It gets the information from currently saved memory.
- ii. Set [Uploaded Data Size].
- iii. Run [Upload Data].
- iv. You can cancel the operation while data is being uploaded. When data reading is complete, OK button is enabled.
- v. If you click OK, recorded data will be shown in two screens - the Grid and the Graph.

(2) Downloading User Images

User Image allows you to download images to KRN50 and change logo, unit and boot images.

You can also reset images back to the original status. This is also a self protocol, so cannot download images during Run.

1) Download logo

You can change the company logo image on contents that are printed on recording paper.

Logo image should be 384 X 80 pixel of bitmap file.

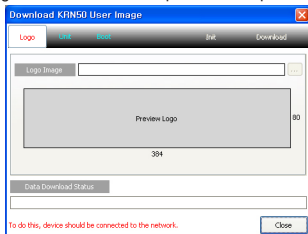

2) Download Units

There are 0-9 user units.

The download procedure is: select a unit list → select a destination to save → double-click a unit image to add the image → download.

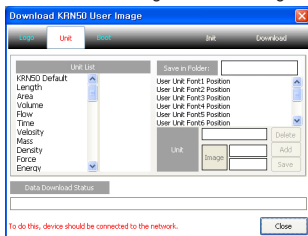

3) Download boot images

The boot image (logo image) appears on LCD upon initial power supply to KRN50.

You can change booting logo image which displays when KRN50 is power ON.

The image should be 128 X 32 pixel of bitmap file.

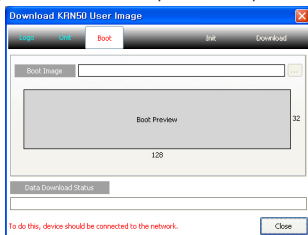

Distributor



ООО "РусАвтоматизация"

454010 г. Челябинск, ул. Гагарина 5, оф. 507
тел. 8-800-775-09-57 (звонок бесплатный),
тел.: (351)799-54-26, тел./факс (351)211-64-57
info@rusautomation.ru; www.rusautomation.ru
русавтоматизация.рф

Autonics

Sensors & Controllers

www.autonics.com

© Headquarters

116, Ungbigongdan-gil, Yangsan-si, Gyeongsangnam-do, Korea

▣ Overseas Sales Dept.

#402-404, Bucheon Techno Park, 655, Pyeongcheon-ro, Wonmi-gu, Bucheon, Gyeonggi-do, Korea

Tel: 82-32-610-2730 / Fax: 82-32-329-0728 / E-mail: sales@autonics.com

■ Brazil Autonics do Brasil Comercial Importadora Exportadora Ltda

Tel: 55-11-2307-8480 / Fax: 55-11-2309-7784 / E-mail: vendas@autonics.com.br

■ China Autonics electronic(Jiaxing) Corporation

Tel: 86-573-8216-1900 / Fax: 86-573-8216-1917 / E-mail: china@autonics.com

■ India Autonics Corporation - India Liaison Office

Tel: 91-22-2781-4305 / Fax: 91-22-2781-4518 / E-mail: india@autonics.com

■ Indonesia PT. Autonics Indonesia

Tel: 62-21-658 66 740 / Fax: 62-21-658 66 741 / E-mail: indonesia@autonics.com

■ Japan Autonics Japan Corporation

Tel: 81-265-79-8570 / Fax: 81-265-79-2442 / E-mail: support@autonicsjp.co.jp

■ Malaysia Mal-Autonics Sensor Sdn. Bhd.

Tel: 60-3-7805-7190(Hunting) / Fax: 60-3-7805-7193 / E-mail: malaysia@autonics.com

■ Mexico Autonics Mexico Sales Office

Tel: 52-55-5207-0019 / Fax: 52-55-1663-0712 / E-mail: ventas@autonics.com

■ Russia Autonics Corp. Russia Representative Office

Tel/Fax: 7-495-660-10-88 / E-mail: russia@autonics.com

■ Turkey Autonics Otomasyon Ticaret Ltd. Sti.

Tel: 90-216-365-9117 / Fax: 90-216-365-9112 / E-mail: info@autonics.com.tr

■ USA Autonics USA, Inc.

Tel: 1-847-680-8160 / Fax: 1-847-680-8155 / E-mail: sales@autonicsusa.net

■ Vietnam Autonics Vietnam Representative Office

Tel: 84-8-3771-2662 / Fax: 84-8-3771-2663 / E-mail: vietnam@autonics.com

Major products

- Photoelectric sensors • Fiber optic sensors • Door sensors • Door side sensors • Area sensors • Proximity sensors • Pressure sensors
- Rotary encoders • Connectors/sockets • Temperature controllers • Temperature/Humidity transducers • SSR/Power controllers
- Counters/Timers/Panel meters • Tachometer/Pulse(Rate)meters • Display units • Sensor controllers • Switching mode power supplies
- Control switches/Lamps/Buzzers • I/O Terminal Blocks & Cables-Stepper motors/drivers/motion controllers • Graphic/Logic panels
- Field network devices Laser marking system(Fiber, CO₂, Nd:YAG) • Laser welding/soldering system
- Recorders/Indicators • Converters • Controllers • Thyristor units • Pressure transmitters • Temperature transmitters

■ Any proposal for product improvement and development : product@autonics.com