

SPX Digital Type Thermal Dispersion Flow Switch Operation Manual



CONTENTS

1. Reading labels	1
2. Product warranty	2
2.1 New product warranty	2
2.2 Repair warranty	2
2.3 Service network	3
3. Product Inspection	4
3.1 Check content	4
3.2 Safety Inspection	4
4. Product Overview	5
4.1 Working Principles	5
4.2 Product Features	5
4.3 Dimension	6
4.4 Product Applications	6
5. Product Specifications	7
6. Panel	8
6.1 Wiring Diagram	9
7. Installation Instructions	10
7.1 Precautions	10
8. Operating Instructions	11
8.1 Basic Setting	11
8.1.1 Alarm setting	11
8.2 Advanced Setting	12
8.2.1 Switch output point switching	12
8.2.2 Reset to the factory setting	13
8.2.3 Button locking and unlocking setting	13
9. Storage And Transport Requirements	14
9.1 Transport Requirements	14
10. Error Message And Troubleshooting	14

1. Reading labels

Thanks for purchasing FineTek's Product. This operation manual describes the product features, working principles, operation and maintenance methods. It makes the user fully understand how to use the product correctly, so as to prevent dangerous situations such as device damage or operator injury.

- Please read this operation manual completely and carefully before using the product.
- Please contact the company if this operation manual can't satisfy your demands.
- The content of the operation manual is updated based on the version upgrade, which will be uploaded to the website for the user to access.
- Please don't disassemble or repair the product on your own, as this will make you disqualified from availing of the warranty service. Please send the product back to the company for repair and calibration, or just contact the company.
- Explanation of warning signs:



Danger→ It indicates that wrong operation will cause death or major disasters.



Note→ It indicates that wrong operation will cause injury and device damage to some extent.



Electric shock→ It warns of possible electric shock.



Fire→ It warns of possible fire.



Prohibited→ It indicates the prohibited wrong behavior.

2. Product warranty

2.1 New product warranty

- We don't charge for the inspection, part/s and repair for the product of the company that has a defect within 12 months from the delivery date and meets the warranty terms.
- If the product defect is not due to human error during its transportation, user may change to a new unit from the company within 7 days from delivery date.
- When the product needs to be sent back to the factory for repair, please send the whole set, and don't disassemble the parts. Moreover, please be sure it is completely packed to avoid damage and causing more loss and defect during the transportation.
- The warranty is not available for causes that fall under the following circumstances, for which the company shall charge for the inspection, part/s and repair according to the actual condition:
 - The product or its parts are beyond the warranty period.
 - Fault or damage is caused by not following the instruction and use environment described on the operation manual.
 - The product damage is caused by a force majeure factor (natural disasters, floods, fire, earthquakes, lightning, typhoon, etc.), human destruction (scratches, dropping, latch broken, tapping, cracks and punching), human error (using improper voltage, high-humidity, water leakage, stain, corrosion, loss, improper storage, etc.) and other abnormal factors.
 - The damage is caused by the customer or the 3rd party through the installation, addition, expansion, modification and repair of parts not authorized or certified by the company.
 - The volume label information is wrong or unclear, so the product serial number can't be confirmed.

2.2 Repair warranty

A **6-month** warranty service is provided for the repaired part of the product, during which the same product can be repaired free of charge in case of the same fault.

2.3 Service network

Company	Address	Telephon	Fax
Taipei Headquarters (Taiwan)	No.16, Tzuchiang St., Tucheng Industrial Park, New Taipei City 23678	+886 2-2269-6789	+886 2-2268-6682
Taichung Sales office (Taiwan)		+886 4-2465-2820	+886 4-2463-9926
Kaohsiung Sales office (Taiwan)		+886 7-333-6968	+886 7-536-8758
Fine automation Co., Ltd. (China)	No. 451, Duhui Road, Zhuanqiao Township, Minhang District, Shanghai City 201109	+86 021-64907260	+86 021-6490-7276
FineTek Pte Ltd. (Singapore Branch)	37 Kaki Bukit Place, Level 4 Singapore 416215	+65 6452-6340	+65 6734-1878
FineTek GmbH (Germany Branch)	Bei den Kämpen 26 21220 Seevetal-Ramelsloh, Germany	+49 (0) 4185 8083 0	+49 (0) 4185 8083 80
FineTek Co., Ltd. (Indonesia Branch)	PERGUDANGAN TUNAS BITUNG JL. Raya Serang KM. 13,8, Blok C3 No. 12&15, Bitung Cikupa, Tangerang 15710	+62 021-2958-1688	+62 021-2923-1988

3. Product Inspection

3.1 Check content

- Digital Type thermal dispersion flow switch*1

3.2 Safety Inspection

- Make sure the package is not deformed or damaged before you unpack the box. If there is any deformation or damage, take a picture and use it as proof for compensation.
- Make sure the contents are not deformed or damaged and there are no quality problems after you unpack the box. If there is any deformation, damage or quality problem, take a picture and use it as proof for compensation.
- Unpack the box and make sure the contents conform to what you ordered and the quantity is correct without delay.
- If there is any nonconformance, contact us within 7 days after the product arrived (with the picture). Otherwise, we are not responsible for the compensation, make-up, replacement or repair.

4. Product Overview

4.1 Working Principles

Two temperature sensing components are installed in the pipe to be measured and one of them is heated. The other one is not heated to create a temperature difference. When the liquid in the pipe flows faster or slower through these two components, the liquid flowing through the heated component brings the heat away from it and the temperature of this component becomes lower. The temperature difference between these two components is used as a reference to determine the high or low flow rate.

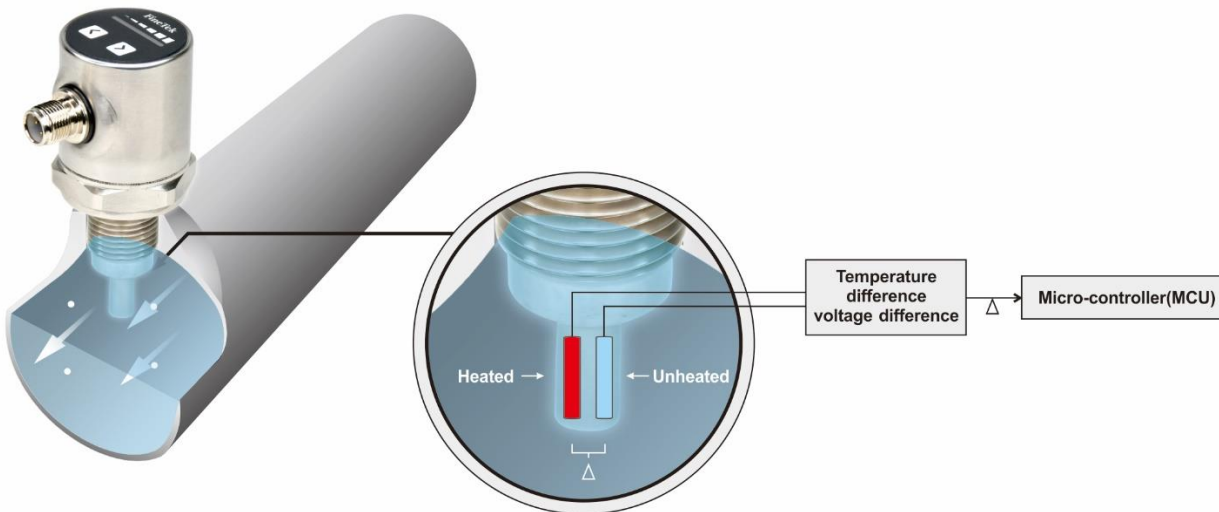

4.2 Product Features

- The digital thermal dispersion flow switch has higher sensitivity than the traditional mechanical switch.
- The installation location is not limited.
- The product does not have moveable mechanical structures and can be used to measure the liquid containing impurities.
- The length of the flow sensing rod can be adapted to the measurement environment and allows a wider range of applications.
- Three signal output methods are available for selection by the user.
- Buttons are replaced with keys to ensure easier adjustment for the user.
- The digital circuit can be set simply using the keys.
- Ten LEDs provide a multi-stage display and facilitate more accurate flow rate sensing.

4.3 Dimension

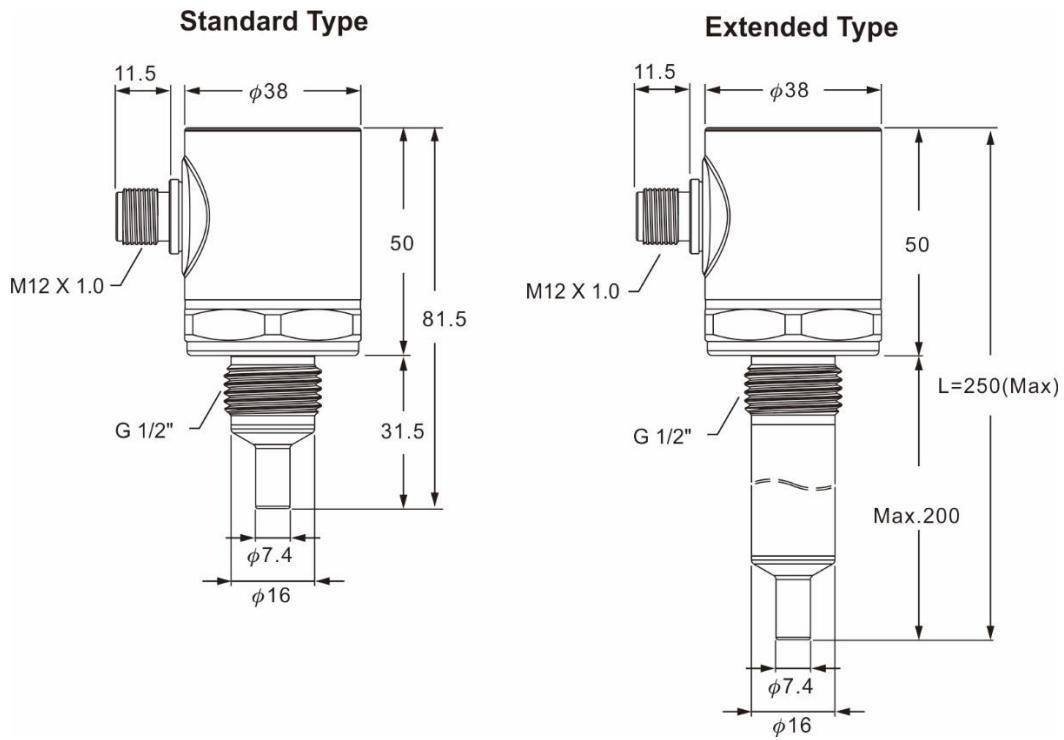

4.4 Product Applications

Flow measurement and control for the ducts or cooling pipes in the hydropower, machine tool, refrigeration and air conditioning, electronics, steel, chemical, shipbuilding, food, pharmaceutical, optical, semiconductor and other industries.

5. Product Specifications

Model	SPX Standard	SPX Elongated
Measuring Range (Flow Rate)	1~150 cm/s (Water)	
Ambient Temperature	-20~80 °C	
Medium Temperature	-20~85 °C	
Alarm Output	Open Collector: NPN/PNP (250mA) Relay: 0.3A@125VAC, 1A@30 VDC (NO or NC)	
Operating Pressure	100 bar (max.)	
LED Indication	Red LED On: The flow rate is lower than the alarm setting; output action Orange LED On: The flow rate is at the alarm setting point Green LED: This indicates a fast or slow flow	
Housing material	SUS304	
Liquid Receiving Material	SUS304	
Protection Level	IP67	
Warm-up Time	ca. 15 seconds	
Connection Thread	G1/2	
Operating Voltage	19~36VDC	
Current Consumption	150mA(Max.at 24VDC)	
Outgoing Line	M12 4PIN Connector: Three-wire (NPN/PNP)/four-wire relay (NO or NC) Power source—brown, grounding—blue, output—black, output—green/white (for relay)	

6. Panel

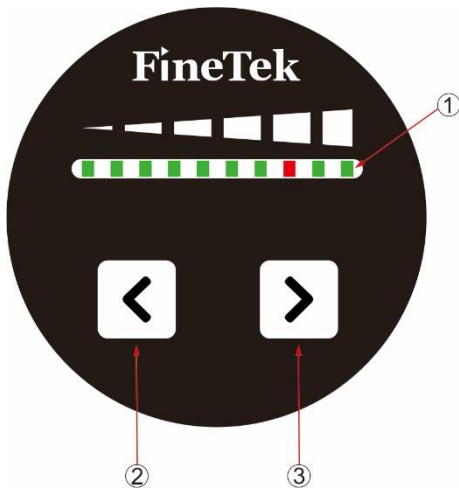

Figure 1

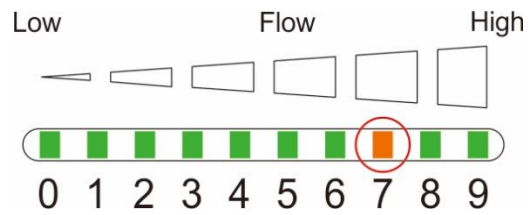

Figure 2

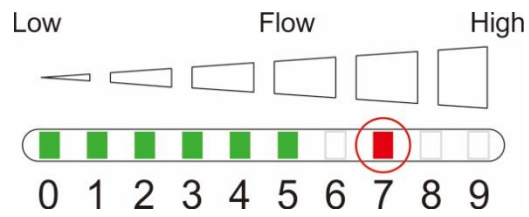

Figure 3

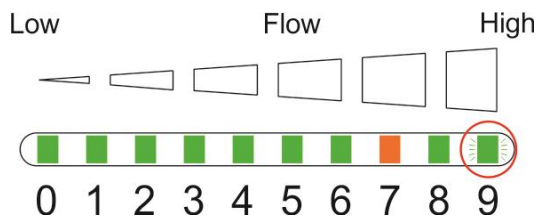

Figure 4

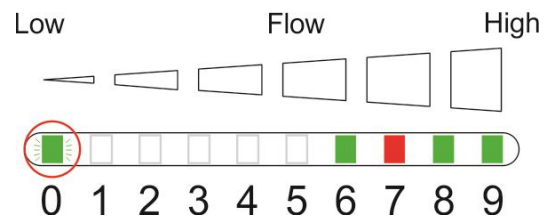
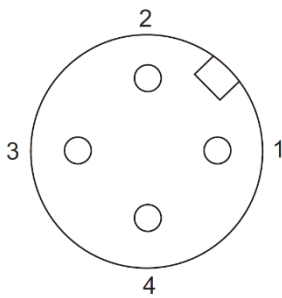
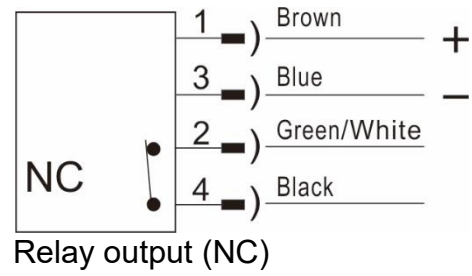
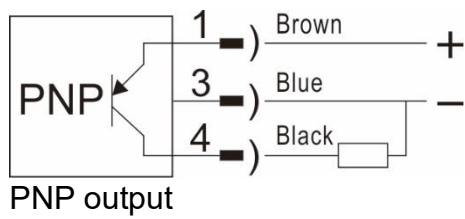
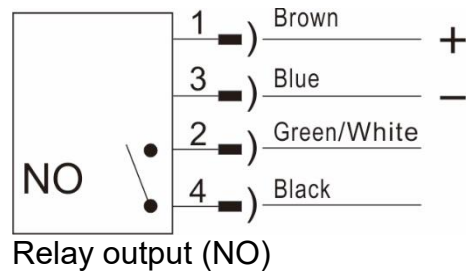
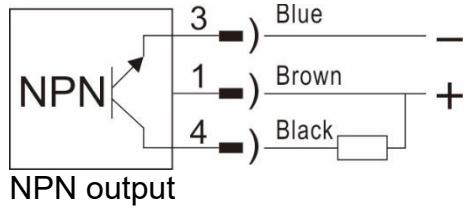

Figure 5

Number	Description
①	<ol style="list-style-type: none"> 1. Ten bicolor LEDs. 2. Green LED On: This LED indicates a fast or slow flow and displays the current flow rate (Figure 1). 3. Orange LED On: (Figure 2) <ul style="list-style-type: none"> ● The flow rate is at the alarm setting point. ● When the switch output functions of the relay (NC/NO) and NPN/PNP (Enable/Disable) switch alternately. 4. Red LED On: The flow rate is lower than the alarm setting; output action (Figure 3) 5. The green LED 9 flashes to indicate that the flow rate exceeds the current maximum flow rate setting (Figure 4). 6. The green LED 0 flashes to indicate that the flow rate is lower than the current minimum flow rate setting (Figure 5).
②	Left arrow key (for setting)
③	Right arrow key (for setting)

6.1 Wiring Diagram



Connector Plugging Diagram
(For NPN & PNP relay output)

7. Installation Instructions

7.1 Precautions

Use the attached waterproof gasket to install SP.

- (1) Make sure the length of the front/rear straight pipe section is greater than 4 times the inner diameter of the pipe (Figure 6).
- (2) Make sure no bubbles exist in the pipe to ensure the normal operation at the alarm point (Figure 7).
- (3) If the pipe is not full of liquid, SP shall be mounted beneath the pipe and the level of the liquid shall be higher than the flow sensing rod (Figure 8).
- (4) SP must be tightened firmly to avoid leakage of the liquid from the pipe, which may bring about danger. SP can be installed at any angle; it will have the best sensitivity and responding speed when installed at the angle as shown in Figure 9.
- (5) The liquid may contain impurities or granules. You may need to mount an appropriate filter at the upstream of the SP to protect it from collision or wear that may shorten its service life.

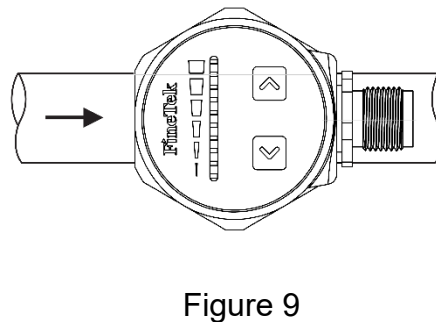
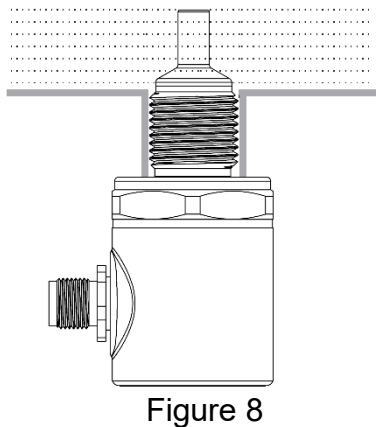
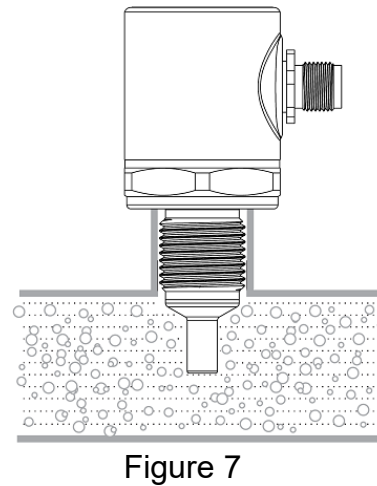
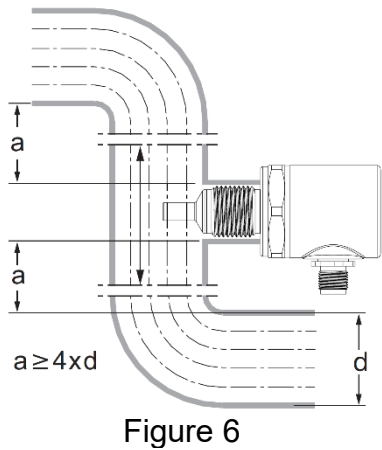

8. Operating Instructions

8.1 Basic Setting

8.1.1 Alarm setting

- (1) Attach SPX to the pipe.
- (2) Turn on the SPX power. All the LEDs light up and then go out one after another to the point that indicates the current environmental velocity. The startup process is completed then and wait at least 15 seconds for warm-up (Figure 10).

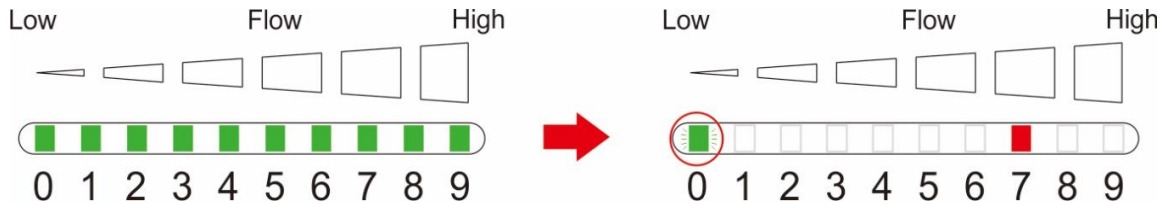

Figure 10

- (3) High flow adjustment:

For setting the current flow rate of the equipment as the maximum value, press and hold the right arrow key \rightarrow to light up the green LED 9 when the flow rate becomes steady after about 10 seconds. The light starts flashing after about 5 seconds and release the key. Then the equipment sets the current flow rate as the maximum value and enters the job mode (Figure 11).

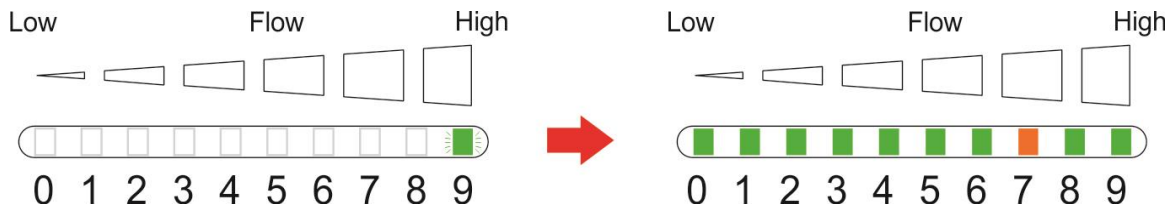

Figure 11

- (4) Low flow adjustment

For setting the current flow rate of the equipment as the minimum value, press and hold the left arrow key \leftarrow to light up the green LED 0 when the flow rate becomes steady after about 10 seconds. The light starts flashing after about 5 seconds and release the key. Then the equipment sets the current flow rate as the minimum value and enters the job mode (Figure 12).



Figure 12

(5) Setting of the location for the flow rate switch point

Click the button (left ◀ or right ▶ arrow key). The LED at the switch point flashes in red. Whenever the arrow button (left or right) is pressed, the red LED moves to the next grid to the direction of the arrow. When the red LED moves to the new alarm point to be set, release the button and wait about 3 seconds. When the red LED stops flashing, the equipment records the new alarm point setting and return to the job mode (Figure 13).



Figure 13

8.2 Advanced Setting

8.2.1 Switch output point switching

(1) Normally closed contact (NC) switches to normally open contact (NO):

Press and hold the left arrow key ◀ for about 1 second and the LED 0 lights up. Keep pressing and holding the left arrow key ◀ for about 5 seconds and the LED 0 flashes. After it keeps flashing for about 5 seconds, the LED 5~9 light up in orange simultaneously. After lighting up for 5 seconds, they switch to the LED 0~4 lighting up in orange at the same time. The LEDs flash thrice simultaneously and the normally closed contact (NC) switches to the normally open contact (NO) right away. Release the button (Figure 14).

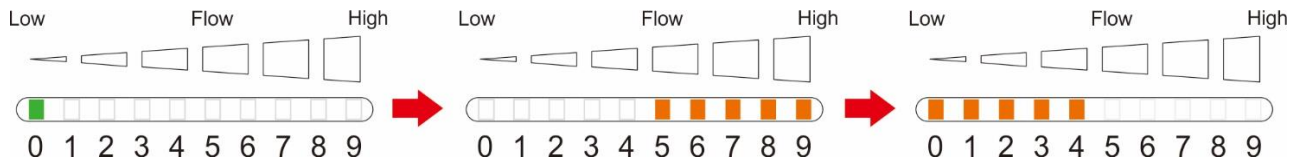

Figure 14

(2) Normally open contact (NO) switches to normally closed contact (NC):

Press and hold the left arrow key ◀ for about 1 second and the LED 0 lights up. Keep pressing and holding the left arrow key ◀ for about 5 seconds and the LED 0 flashes. After it keeps flashing for about 5 seconds, the LED 0~4 light up in orange simultaneously. After lighting up for 5 seconds, they switch to the LED 5~9 lighting up in orange at the same time. The LEDs flash thrice simultaneously and the normally open contact (NO) switches to the normally closed contact (NC) right away. Release the button (Figure 15).

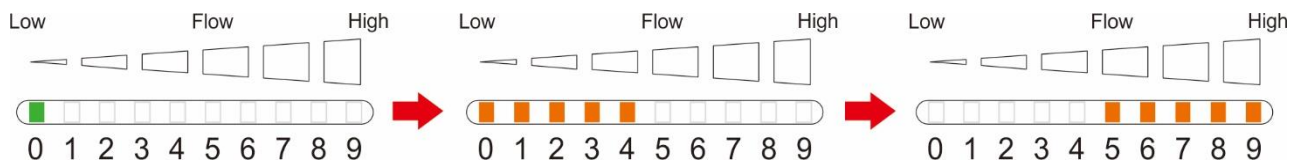



Figure 15

- ※ The factor setting of the NPN/PNP is Enable.
- ※ The factory setting of the relay is NO. It can be changed for purchase.

8.2.2 Reset to the factory setting

Press and hold the right arrow key . The LED 9 lights up and becomes flashing after about 5 seconds. After it keeps flashing for about 10 seconds, the LED 0~9 light up in orange simultaneously. The LEDs flash thrice at the same time and the value is reset to the factory setting. Release the button (Figure 16).

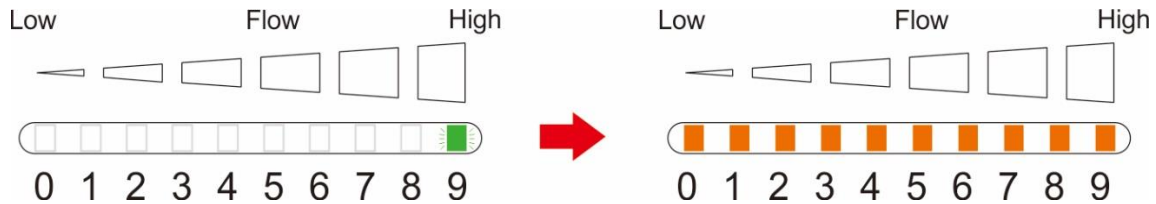





Figure 16

8.2.3 Button locking and unlocking setting

(1) Button locking

Press and hold the left  and right arrow keys  simultaneously for about 10 seconds and the LED 0~9 light up in orange at the same. Release the buttons after they flash thrice simultaneously (Figure 17).

(2) Button unlocking

Press and hold the left  and right arrow keys  simultaneously for about 10 seconds and the LED 0~9 light up in orange at the same. Release the buttons after they flash thrice simultaneously (Figure 17).

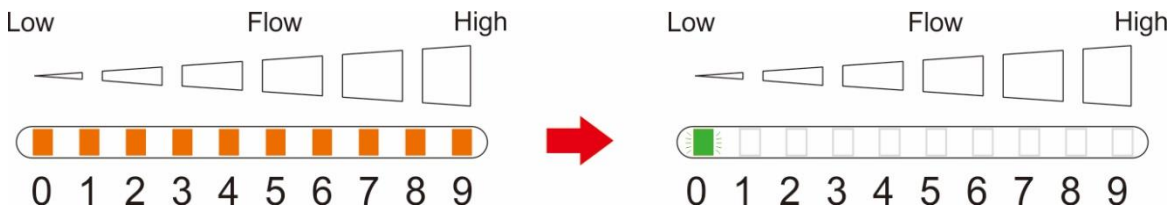

Figure 17

9. Storage And Transport Requirements

9.1 Transport Requirements

To protect the product from damage during the transport, keep it in the package when it is transported from the factory. The place of storage shall meet the following requirements:

- Appropriate protection measures against rain and moisture shall be taken.
- Vibration and collision shall be avoided during the transport.
- Temperature range: -20 to 70 °C
- Humidity: Less than 80%

10. Error Message And Troubleshooting

Error	Inspection	Solution
There is no response or LED indication.	Make sure the power source does not become loss and the M12 cable connector is tightened firmly.	Connect again and restart the product.
The flow rate goes up or down and the switch does not work.	Make sure the wiring of the switch signal and M12 cable connectors does not become lose or come off.	Confirm the wire pin again to ensure the correction connection of the lines.
	Make sure the reset to the factory setting is normal.	If the switch works, go to the setting mode.
	Change the location of the switch point.	If not, contact your local business representative.
The switch signal is not stable and works intermittently.	Make sure the wiring of the switch signal and power cable terminals does not become lose or come off.	If the switch works, go to the setting mode.
	Supply the power again.	If not, contact your local business representative.
The high and low flow rates cannot be set.	Make sure if all the LEDs flash in red during the setting.	Confirm the wire pin again to ensure the correction connection of the lines.