

BS5 SERIES

M A N U A L

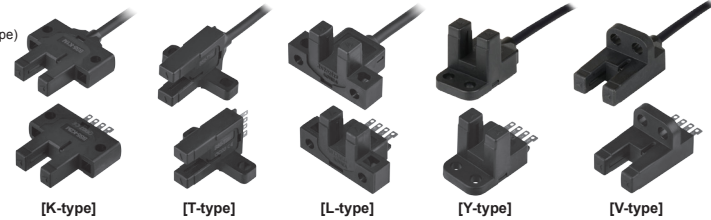

(Connector type)



Thank you for choosing our Autonics product.

Please read the following safety considerations before use.

■ Safety Considerations

※ Please observe all safety considerations for safe and proper product operation to avoid hazards.

※ Safety considerations are categorized as follows.

⚠ Warning Failure to follow these instructions may result in serious injury or death.

⚠ Caution Failure to follow these instructions may result in personal injury or product damage.

※ The symbols used on the product and instruction manual represent the following

⚠ symbol represents caution due to special circumstances in which hazards may occur.

⚠ Warning

1. **Fail-safe device must be installed when using the unit with machinery that may cause serious injury or substantial economic loss.** (e.g. nuclear power control, medical equipment, ships, vehicles, railways, aircraft, combustion apparatus, safety equipment, crime/disaster prevention devices, etc.) Failure to follow this instruction may result in personal injury, fire, or economic loss.
2. **Do not disassemble or modify the unit.** Please contact us if necessary. Failure to follow this instruction may result in electric shock or fire.

⚠ Caution

1. **Check the polarity of the power before wiring the unit.** Failure to follow this instruction may result in product damage. Check the cable position and power voltage range. Cut off the power for wiring cables.
2. **Do not use the unit where flammable or explosive gas may be present.** Failure to follow this instruction may result in fire or explosion.
3. **Do not use water or oil-based detergent when cleaning the unit.** Failure to follow this instruction may result in electric shock or fire.

■ Ordering Information

BS 5 - K 1 M - P

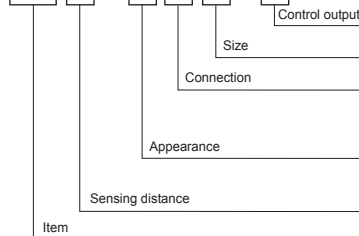

No mark	NPN open collector output
P	PNP open collector output
M	Middle
1	Cable Type
2	Connector Type
K	K-Type
T	T-Type
L	L-Type
Y	Y-Type
V	V-Type
5	Unit: mm (fixed)
BS	Photoelectric sensor series

■ Control Output Circuit Diagram

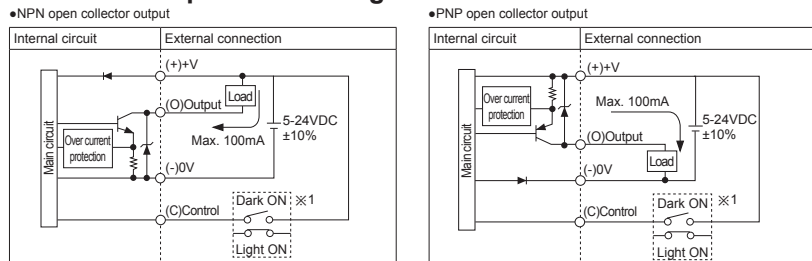

※1: Operation mode selection: Connect Control (C) cable (terminal) into terminal +V (+) to operate Light ON mode. Dark ON mode is available with disconnection status.

■ Connection

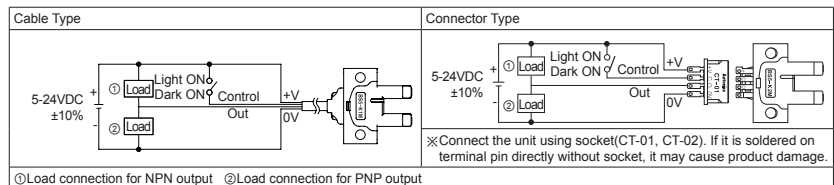

※ The above specifications are subject to change and some models may be discontinued without notice.

■ Dimensions

•BS5-K1M / BS5-K1M-P

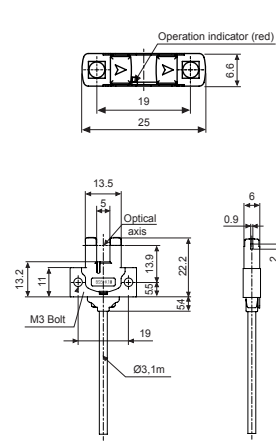

•BS5-T1M / BS5-T1M-P

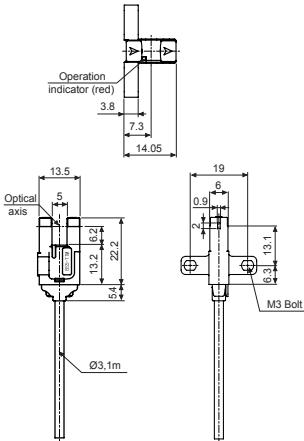

•BS5-L1M / BS5-L1M-P

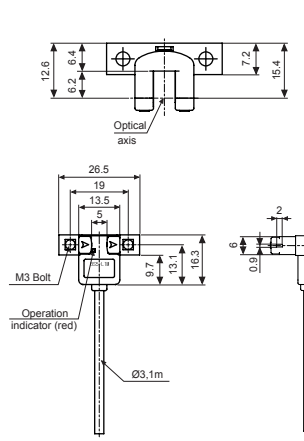

•BS5-Y1M / BS5-Y1M-P

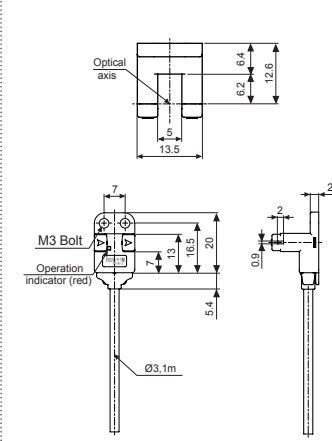

•BS5-V1M / BS5-V1M-P

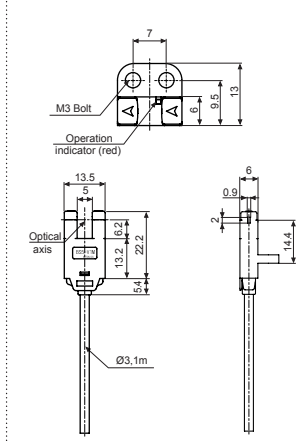

•BS5-K2M / BS5-K2M-P

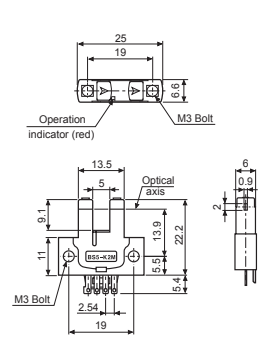

•BS5-T2M / BS5-T2M-P

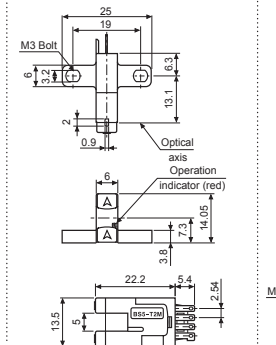

•BS5-L2M / BS5-L2M-P

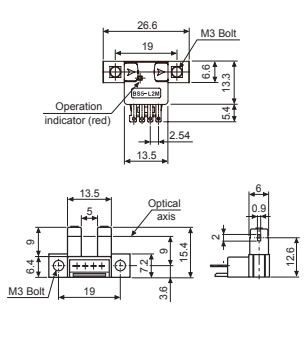

•BS5-Y2M / BS5-Y2M-P

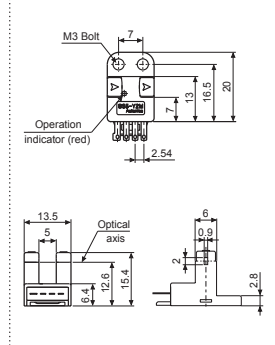

•BS5-V2M / BS5-V2M-P

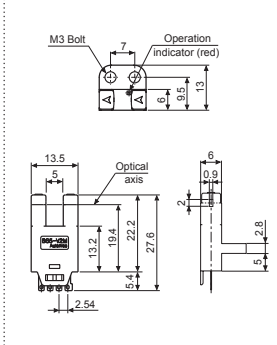

•Hole cut-out when inputting socket on PCB

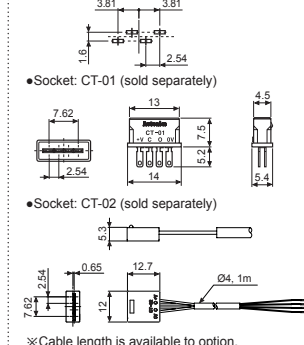

■ Specifications

Model	NPN open collector output	BS5-K1M	BS5-T1M	BS5-L1M	BS5-Y1M	BS5-V1M	BS5-K2M	BS5-T2M	BS5-L2M	BS5-Y2M	BS5-V2M
Model	PNP open collector output	BS5-K1M-P	BS5-T1M-P	BS5-L1M-P	BS5-Y1M-P	BS5-V1M-P	BS5-K2M-P	BS5-T2M-P	BS5-L2M-P	BS5-Y2M-P	BS5-V2M-P
Sensing type	Through-beam (not modulated)										
Sensing distance	5mm fixed										
Sensing target	0.8 × 2mm Opaque materials										
Hysteresis	0.05mm										
Response time	Light ON: Max. 20μs, Dark ON: Max. 100μs										
Response frequency ^{※1}	2kHz										
Power supply	5-24VDC ±10% (ripple P-P: Max. 10%)										
Power supply	Max. 30mA (at 26.4VDC)										
Light source	Infrared LED (940nm)										
Operation mode	Light ON, Dark ON selectable by control wire						Light ON, Dark ON selectable by control terminal				
Control output	NPN or PNP open collector output • Load voltage: Max. 30VDC • Load current: Max. 100mA • Residual voltage: Max. 1.2V										
Protection circuit	Reverse power polarity protection, Overcurrent protection										
Indicator	Operation Indicator: red LED										
Connection	Cable type						Connector type				
Insulation resistance	Min. 20MΩ (at 250VDC megger)										
Noise resistance	±240V the square wave noise (pulse width: 1μs) by the noise simulator										
Dielectric strength	1,000VAC 50/60Hz for 1 minute										
Vibration	1.5mm amplitude at frequency of 10 to 55Hz (for 1 min.) in each X, Y, Z direction for 2 hours										
Shock	500m/s ² (approx. 50G) in X, Y, Z directions for 3 times										
Environment	Ambient illumination: Fluorescent lamp: Max. 1,000lx (receiver illumination)										
Environment	Ambient temperature: -20 to 55°C, Storage: -25 to 85°C										
Environment	Ambient humidity: 35 to 85%RH, Storage: 35 to 85%RH										
Protection	IP50 (IEC standard)										
Material	PBT										
Cable	Ø3mm, 4-wire, 1m (AWG28, Core diameter: 0.08mm, Number of cores: 19, Insulator out diameter: Ø0.88mm)										
Approval	CE										
Weight ^{※2}	Approx. 50g (Approx. 30g)										

※1: Response frequency is the value getting from revolving the circle panel below.

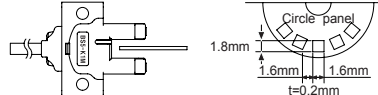

※2: The weight includes packaging. The weight in parentheses is for unit only.

※ The temperature or humidity mentioned in Environment indicates a non freezing or condensation environment.

■ Operation Mode

Operation mode	Light ON	Dark ON
Receiver operation	Received light Interrupted light	Received light Interrupted light
Operation indicator (Red LED)	ON OFF	ON OFF
Transistor output	ON OFF	ON OFF

■ Caution During Use

1. There is no protection of external light source in this unit which is for built-in, please intercept external light source from the receiver.
2. When wiring the photoelectric sensor with high voltage line, power line in a same conduit, it may cause malfunction or mechanical problem, please do wire separately or use different conduit.
3. If there are machines generating noise at surrounding photomicro sensor (Switching regulator, inverter motor etc.), be sure to earth F.G. terminals of machines.
4. For soldering on the connector type terminals, keep the temperature max. 260°C and do not heat for more than 3 sec. Solder 1.5mm away from terminal source part.
5. Use M3 screws and tighten with max. 0.49N·m (5.0kgf·cm) torque. When screwing, use a flat washer (Ø6). Be sure that sensing part is not to be touched by any objects. If the sensing part is damaged, it may cause malfunction.
6. If the sensor is installed at place where there are a lot of dust and humidity, clear the receiver and the emitter with dry cloth. Pollution of the receiver and the emitter can occur malfunction of the sensor.
7. Do not install the unit at the below environment to prevent from product malfunction or damage.
 - ① Place where heavy steam, or dust may be present.
 - ② Place where water, oil, or chemicals (oil-based detergent, acid alkali, aromatic hydrocarbon, etc.) is directly contacted.
 - ③ Outdoor or place where the ray of the sun is directly contacted.
8. This unit may be used in the following environments.
 - ① Indoors
 - ② Altitude: under 2,000m
 - ③ Pollution degree 2
 - ④ Installation category II

※ Failure to follow these instructions may result in product damage.

■ Major Products

- Photoelectric Sensors
- Fiber Optic Sensors
- Door Sensors
- Door Side Sensors
- Area Sensors
- Proximity Sensors
- Pressure Sensors
- Rotary Encoders
- Connector/Sockets
- Switching Mode Power Supplies
- Control Switches/Lamps/Buzzers
- I/O Terminal Blocks & Cables
- Stepper Motors/Drivers/Motion Controllers
- Graphic/Logic Panels
- Field Network Devices
- Laser Marking System (Fiber, Co., Nd:yag)
- Laser Welding/Cutting System
- Temperature Controllers
- Temperature/Humidity Transducers
- SSRs/Power Controllers
- Counters
- Timers
- Panel Meters
- Tachometers/Pulse (Rate) Meters
- Display Units
- Sensor Controllers

ООО "РусАвтоматизация"
 454010 г. Челябинск, ул. Гагарина 5, оф. 507
 тел. 8-800-775-09-57 (звонок бесплатный),
 тел.: (351)799-54-26, тел./факс (351)211-64-57
 info@rusautomation.ru; www.rusautomation.ru
 русавтоматизация.рф