

PULSE METER MP5Y SERIES

M A N U A L



Thank you very much for selecting Autonics products.
For your safety, please read the following before using.

Caution for your safety

- ※ Please keep these instructions and review them before using this unit.
- ※ Please observe the cautions that follow;
 - Warning** Serious injury may result if instructions are not followed.
 - Caution** Product may be damaged, or injury may result if instructions are not followed.
- ※ The following is an explanation of the symbols used in the operation manual.
 - Caution:** Injury or danger may occur under special conditions.

Warning

- 1. In case of using this unit with machineries(Nuclear power control, medical equipment, vehicle, train, airplane, combustion apparatus, entertainment or safety device etc), it requires installing fail-safe device, or contact us for information on type required.**
It may result in serious damage, fire or human injury.
- 2. It must be mounted on panel.**
It may give an electric shock.
- 3. Do not repair or check up when power on.**
It may give an electric shock.
- 4. Do not disassemble and modify this unit, when it requires. If needs, please contact us.**
It may give an electric shock and cause a fire.
- 5. Please check the number of terminal when connect power line or measuring input.**
It may cause a fire.

Caution

- 1. This unit shall not be used outdoors.**
It might shorten the life cycle of the product or give an electric shock.
- 2. When wire connection for power input and measuring input, the tightening strength for screw bolt on terminal block should be over than 0.74N · m ~ 0.90N · m.**
It may result in malfunction or fire due to contact failure.
- 3. Please observe specification rating.**
It might shorten the life cycle of the product and cause a fire.
- 4. In cleaning the unit, do not use water or an oil-based detergent.**
It might cause an electric shock or fire that will result in damage to this product.
- 5. Do not use this unit at place where there are flammable or explosive gas, humidity, direct ray the sun, radiant heat, vibration, impact etc.**
It may cause a fire or explosion.
- 6. Do not inflow dust or wire dregs into inside of this unit.**
It may cause a fire or mechanical trouble.
- 7. Please connect properly after checking the polarity of measuring terminals.**
It may cause a fire or explosion.

※ The above specification are changeable without notice anytime.

Ordering information

① Series	MP	Pulse meter	
② Digit	5	5digit(99999)	
③ Size	Y	DIN Size W72 × H36mm	
④ Power supply	4	100-240VAC 50/60Hz	
⑤ Output (Main Output + Sub output)	N	Indication type only	X
	1	NPN open collector five-stage output	X
	2	PNP open collector five-stage output	X
	3	X	BCD Dynamic
	4	X	PV Retransmission(4-20mADC)
5	X	RS485 communication	

※ PNP open collector output: Option

Specifications

Model	MP5Y	
Power supply	100-240VAC 50/60Hz	
Allowable operation voltage	90 to 110% of rated voltage	
Power consumption	Approx. 3.5VA(240VAC)	
Power for external sensor	12VDC ±10%, 80mA	
Measuring accuracy (23 ±5°C)	• Mode F1, F4, F7, F8, F9, F10 : F.S. ±0.05% rdg ±1Digit • Mode F2, F3, F5, F6 : F.S. ±0.01% rdg ±1Digit	
Measuring range	• Mode F1, F4, F7, F8, F9, F10 : 0.0005Hz to 50kHz • Mode F3 : 0.02s to 3,200s • Mode F2, F5, F6 : 0.01s to 3,200s • Mode F11, F12, F13 : 0 to 4 × 10 Count	
Input frequency	• Solid state input : Max. 50kHz(Pulse width:Min. 10 μ s) • Contact input : Max. 45Hz(Pulse width:Min. 11ms)	
Input level	[Voltage input] High : 4.5-24VDC, Low : 0-1VDC, Input impedance : 4.5k Ω [No-voltage input] Short-circuit impedance : Max. 300 Ω , Residual voltage : Max. 1V, Open-circuit impedance : Min. 100k Ω	
Max. indication	5digit(-19999 to 99999)	
Display method	7 Segment LED(Zero Blanking), Display Size : 6.8 × 13.8	
Display accuracy	0.05 / 0.5 / 1 / 2 / 4 / 8sec.(The same as update output cycle)	
Operation mode	Number of revolution/Speed/Frequency(F1), Passing speed(F2), Cycle(F3), Passing time(F4), Time width(F5), Time difference(F6), Absolute rate(F7), Error ratio(F8), Density(F9), Error(F10), Length measurement(F11), Interval(F12), Integration(F13)	
Prescale function	Direct input method(0.0001 × 10 ⁻⁹ to 9.9999 × 10 ⁹)	
Hysteresis	0 to 9999	
Other functions	• Lock setting function • Monitoring delay function • Auto-Zero time setting function • Monitoring function : Memorize max. value or min. value • Current output range selection(Current output type only) • Remote/Local switching function(Communication output type only) • Comparative output function(HH, H, GO, L, LL) • Time unit selection function • Memory retention function(Mode F13 applied only) • Deviation memory function(F output mode applied only) ※ Please see the last page for the detail.	
Output form	• Transistor output(NPN/PNP open collector) : Comparative output, Alarm output • BCD Dynamic output : Display value output • PV transmission output(4-20mADC) : Display value output • RS485 communication output(32 channel) : Display value output, Comparative output, PC setting function	
Memory	Non-volatile memory(Input times : 100,000 times)	
Insulation resistance	Min. 100M Ω (Standard 500VDC) between terminal and case	
Dielectric strength	2000VAC 60Hz 1minute(Between terminals of AC power and case, Between terminals of AC power and measuring terminals)	
Impulse noise strength	±2000V the square wave noise(pulse width:1 μ s) by the noise simulator	
Vibration	Mechanical	0.75mm amplitude at frequency of 10 to 55Hz in each of X, Y, Z directions for 2 hour
	Malfunction	0.5mm amplitude at frequency of 10 to 55Hz in each of X, Y, Z directions for 10 minutes
Shock	Mechanical	300m/s ² (Approx. 30G) 3 times at X, Y, Z direction
	Malfunction	100m/s ² (Approx. 10G) 3 times at X, Y, Z direction
Ambient temperature	-10 to 50°C(at non-freezing status)□	
Storage temperature	-20 to 60°C(at non-freezing status)□	
Ambient humidity	35 to 85%RH	
Weight	Approx. 135g	

Dimensions

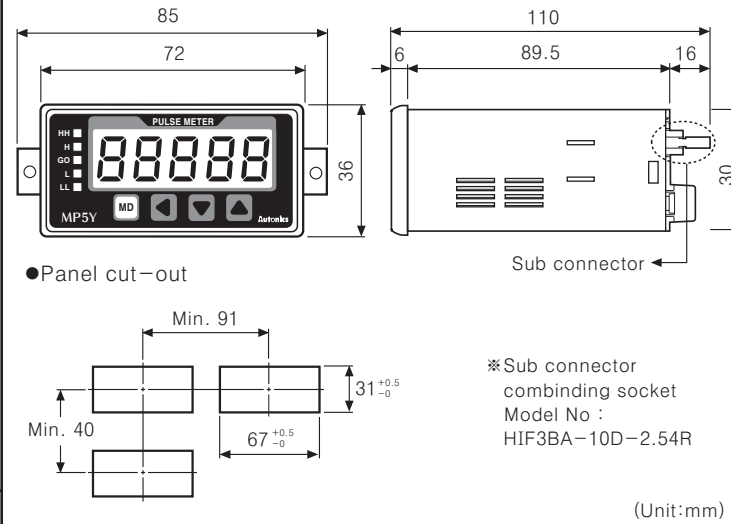

Connections

Main terminal block

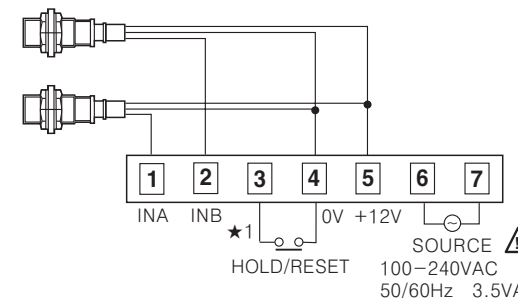

Main output(Comparative output) connector

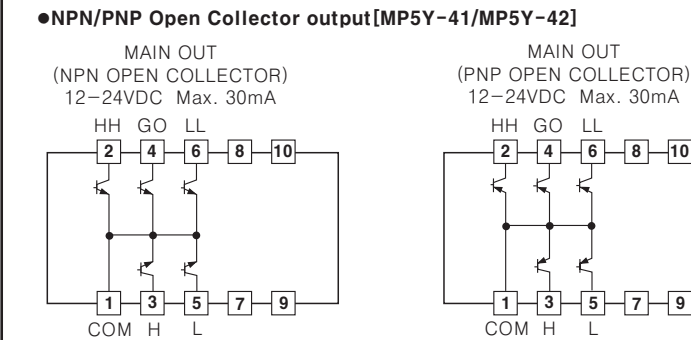

Sub output(Display value output) connector

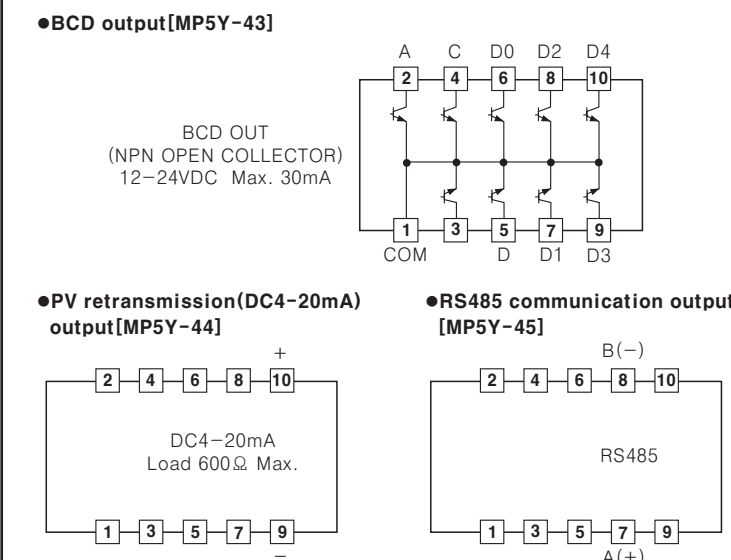

Input · Output

Input specification

1. Input signal
 - ① Solid state input
 - ① Input frequency : 50kHz(Max.)
But, standard duty rate of input signal is 1:1, ON/OFF pulse width should be each over 10 μ s.
 - ② Input voltage Level : ON voltage → 4.5-24V, OFF voltage → 0-1.0V
-
- ② Relay contact input
 - ① Input frequency : 45Hz(Max.)
But, ON/OFF pulse width should be each over 11ms.
 - ② Relay contact specification : Please use a contact that can switch reliably at 12VDC, 2mA min. of load current.

2. Input type
MP5Y has **NPN input and PNP input** and it is able to select it in Parameter 1 group.

(1)NPN input type

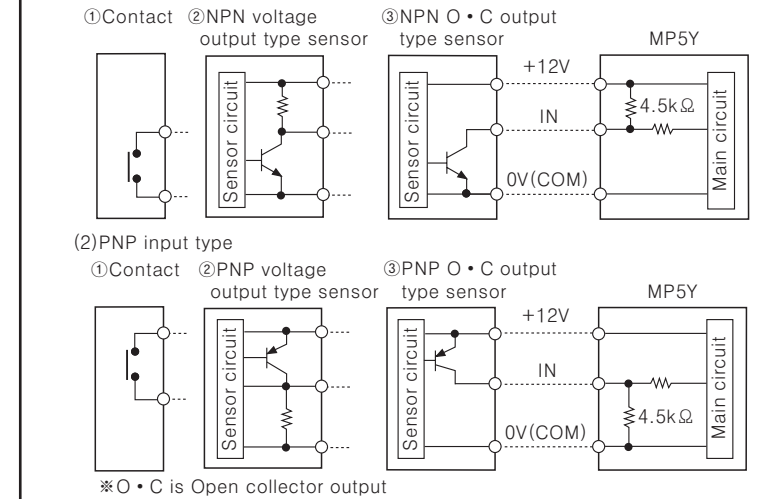

(2)PNP input type

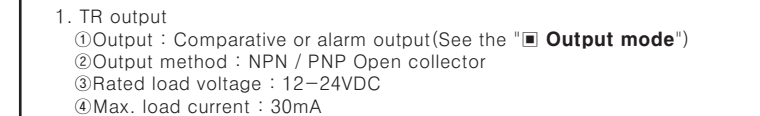

Output specification

1. TR output
 - ① Output : Comparative or alarm output(See the "Output mode")
 - ② Output method : NPN / PNP Open collector
 - ③ Rated load voltage : 12-24VDC
 - ④ Max. load current : 30mA
2. BCD Dynamic output
 - ① Output : Display value
 - ② Output signal : BCD Data(A, B, C, D) ← A : Lowest bit, D : Highest bit
Digit Data(D0, D1, D2, D3, D4) ← D0 : Lowest digit, D4 : Highest digit
 - ※ There is no DOT Data output, please put decimal point in external.
 - ③ Output type : NPN Open Collector
 - ④ Rated load voltage : 12-24VDC
 - ⑤ Max. load current : 30mA

Ex) When display value is 12589

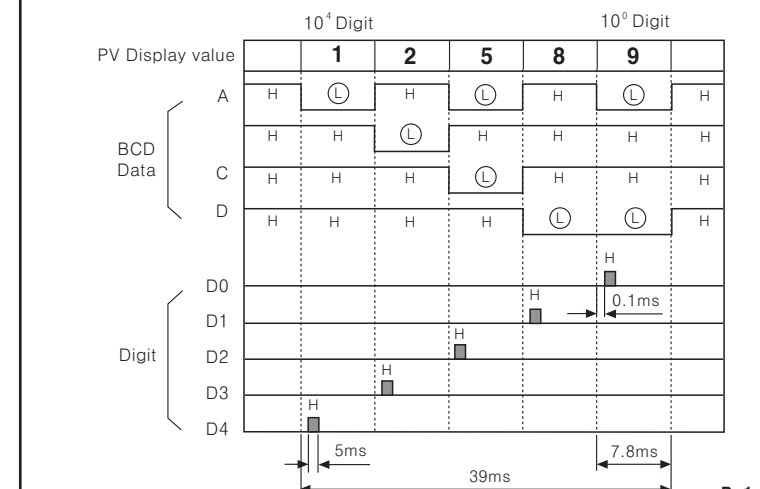

3. PV retransmission output(4-20mADC)

- ①Application : To transmit the measured value
- ②Function : This function is to transmit 4-20mADC converted from measured display value between High limit output(FS-H) and Low limit (FS-L).
- ③Range of High/Low limit output setting
 - High limit setting range(FS-H) : From min. to max within range of measurement
 - Low limit setting range(FS-L) : From min. to max within range of measurement (FS-H should be over "1" bigger than FS-L)
- ④Resistive load : Max. 600Ω
- ⑤Resolution : 8000 divisions

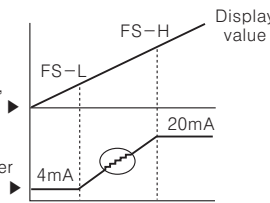

If set FS-L and FS-H in certain section, the output will be 4-20mADC.

Revolution between FS-L and FS-H is 8000, therefore if display value is narrower than 8,000 the resolution will be low.

6. RS485 communication output

- ①Address : 0 ~ 99 address(32 channel)
- ②Transmission speed(Baud rate) : 2400/4800/9600 bps
- ③Transmission code : ASCII
- ④Parity Bit : No ⑤Data Bit : 8 Bit ⑥Stop Bit : 1 Bit
- ⑦Communication items
 - MP5Y ← PC : Comparative value, Prescale value and Peak value, RESET control
 - MP5Y → PC : Comparative value, Prescale value and Peak value, Display value

■ Operation mode

- Select operation mode from **mode** (mode) of Parameter 1 group.
- There are 13 kinds of operation mode.

●Mode F1(Frequency/Number of revolution/Speed)

This mode is to display calculated frequency or number of revolution, speed by measuring frequency of Input A,

- 1) Frequency(Hz) = $f \times \alpha$ ($\alpha = 1[\text{sec}]$)
- 2) Number of revolution(rpm) = $f \times \alpha$ ($\alpha = 60[\text{sec}]$)
- 3) Speed(m/min) = $f \times \alpha$ ($\alpha = 60L[\text{sec}]$)

*L : The length of conveyor moved for 1 pulse cycle[m]

●Display value and display unit

Display value	Display unit	α (Prescale value)
Frequency	Hz	1
	kHz	0.001
Number of revolution	RPS	1
	rpm	60
Speed	mm / sec	1,000L
	cm / sec	100L
	m / sec	L
	m / min	60L
	km / hour	3.6L

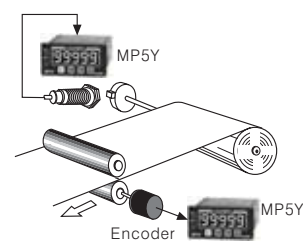

*Display unit of factory default : rpm

●Time chart

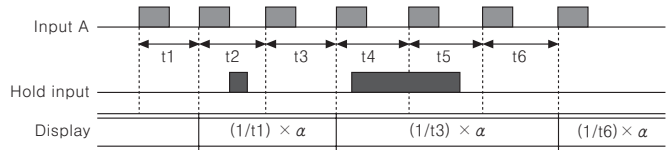

●Mode F2(Passing speed)

It displays the passing speed between ON of input A and ON of input B. Passing speed(V) = $f \times \alpha$ ($\alpha = L[\text{m}]$)

*f : This is reciprocal number of the time between ON of input A and ON of input B. L : The distance between input A and input B[m]

●Display value and display unit

Display value	Display unit	α (Prescale value)
Passing speed	mm / sec	1,000L
	cm / sec	100L
	m / sec	L
	m / min	60L
	km / hour	3.6L

*Display unit of factory default : m/sec

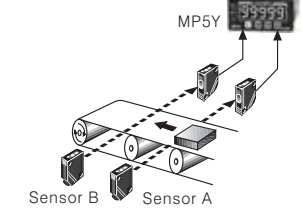

●Time chart

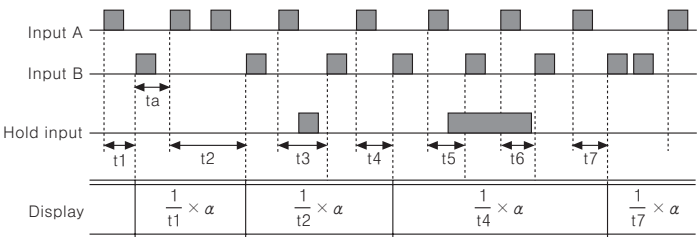

*alpha : Prescale value
ta : It needs min. 20ms for return time

●Mode F3(Cycle)

It displays the time from when input A is ON to the next ON of input A.

Cycle(T) = t

*t : Measurement time[sec]

●Display value and display unit

Display value	Display unit	
	SEC	MIN
Cycle	999.99sec.	999.99min.
	9999.9sec.	9999.9min.
	99min.	99hour 99min.
	99hour 59.9sec.	99hour 59.9min.
	9hour 59min. 59sec.	999hour 59min.
	99999sec.	99999min.

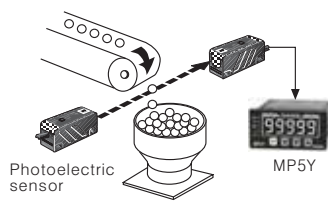

*Set the display unit at the **Unit** (Time unit) of Parameter 2.
*Display unit of factory default : 999.99sec.

●Time chart

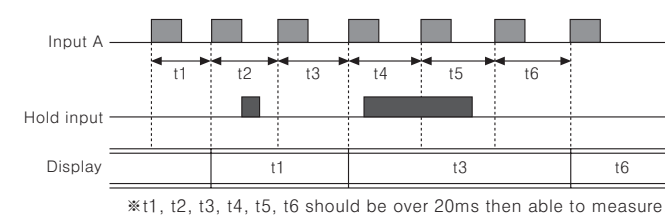

*t1, t2, t3, t4, t5, t6 should be over 20ms then able to measure.

●Mode F4(Passing time)

It displays the passing time of certain distance as measuring the time between ON and the next ON of Input A.

$$\text{Passing time}[\text{sec}] = t \times \alpha \left(\alpha = \frac{L[\text{m}]}{\text{Moving distance within 1pulse cycle}[\text{m}]} \right)$$

*t: Measurement time[sec], L: Certain distance[m]

●Display value and display unit

Display value	Display unit	
	SEC	MIN
Passing time	999.99sec.	999.99min.
	9999.9sec.	9999.9min.
	99hour 59.9sec.	99hour 59.9min.
	9hour 59min. 59sec.	999hour 59min.
	99999sec.	99999min.

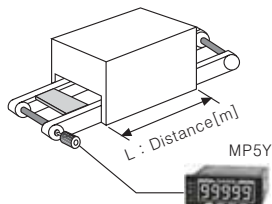

*Display unit of factory default : 999.99sec.
*Set the display unit at the **Unit** (Time unit) of Parameter 2.

●Time chart

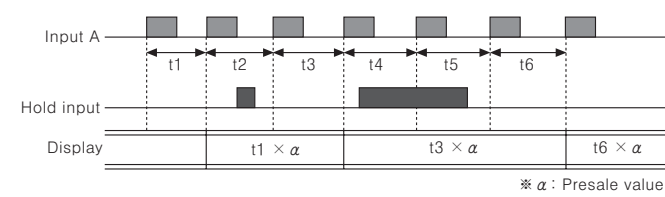

*alpha : Prescale value

●Mode F5(Time width)

It displays the ON time of input A.

Time width[T] = t

*t : ON measurement time of input A[sec]

●Display value and display unit

Display value	Display unit	
	SEC	MIN
Passing time	999.99sec.	999.99min.
	9999.9sec.	9999.9min.
	99hour 59.9sec.	99hour 59.9min.
	9hour 59min. 59sec.	999hour 59min.
	99999sec.	99999min.

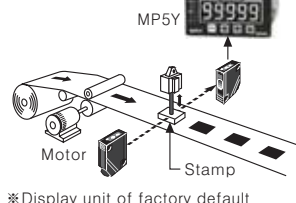

*Display unit of factory default : 999.99sec.

*Set the display unit at the **Unit** (Time unit) of parameter 2.
*Display unit of factory default : 999.99sec.

●Time chart

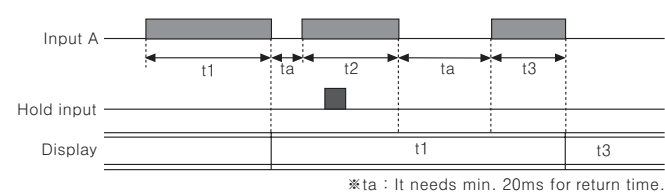

*ta : It needs min. 20ms for return time.

●Mode F6(Time interval)

It displays the time from input A is ON to input B is ON.

Time difference(T) = t(ta to tb)

*t(ta to tb) : The measurement time from input A is ON to input B is ON[sec]

●Display value and display unit

Display value	Display unit	
	SEC	MIN
Passing time	999.99sec.	999.99min.
	9999.9sec.	9999.9min.
	99hour 59.9sec.	99hour 59.9min.
	9hour 59min. 59sec.	999hour 59min.
	99999sec.	99999min.

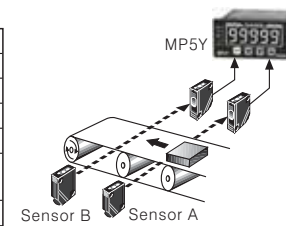

*Display unit of factory default : 999.99sec.
*Display unit can be set at **Unit** (Time unit) of Parameter 2.

●Time chart

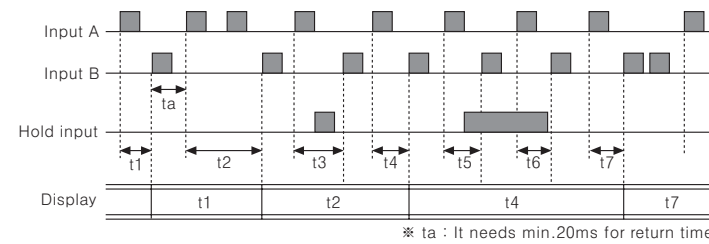

*ta : It needs min.20ms for return time.

●Mode F7(Absolute rate)

It displays how many percentage(%) faster or late, speed, volume etc. of Input B against input A)

Absolute rate = (Input B / Input A) x 100%

$$\text{Absolute rate} = \frac{\text{Frequency of input B}[\text{Hz}] \times B\alpha}{\text{Frequency of input A}[\text{Hz}] \times A\alpha} \times 100[\%]$$

●Display value and display unit

Display value	Display unit
Absolute rate	%

*Aα : Prescale value of input A
*Bα : Prescale value of input A

●Time chart

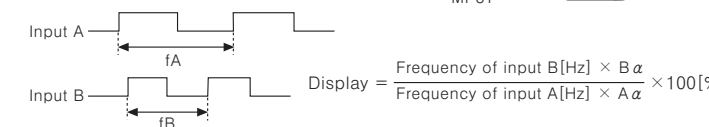

*Hold : Hold signal is ON, the display value will be held until hold signal is OFF.

●Mode F8(Error ratio)

It displays how many percentage(%) faster or late of Input B against Input A.

$$\text{Absolute ratio} = \frac{\text{Input B} - \text{Input A}}{\text{Input A}} \times 100[\%]$$

$$\text{Error ratio} = \frac{(\text{Frequency of input B}[\text{Hz}] \times B\alpha) - (\text{Frequency of input A}[\text{Hz}] \times A\alpha)}{\text{Frequency of input A}[\text{Hz}] \times A\alpha} \times 100[\%]$$

●Display value and display unit

Display value	Display unit
Error rate	%

*Aα : Prescale value of input A
*Bα : Prescale value of input B

●Time chart

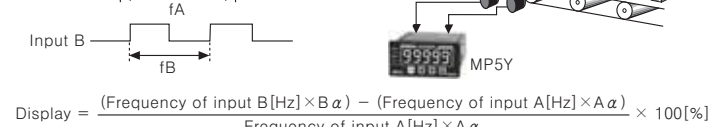

*Hold : Hold signal is ON, the display value will be held until hold signal is OFF.

●Mode F9(Density)

It displays the density rate of input B against total sum of input A and input B.

$$\text{Density} = \frac{\text{Input B}}{\text{Input A} + \text{Input B}} \times 100[\%]$$

$$\text{Density} = \frac{\text{Frequency of input B}[\text{Hz}] \times B\alpha}{(\text{Frequency of input A}[\text{Hz}] \times A\alpha) + (\text{Frequency of input B}[\text{Hz}] \times B\alpha)} \times 100[\%]$$

●Display value and display unit

Display value	Display unit
Density	%

*Aα : Prescale value of input A
*Bα : Prescale value of input B

●Time chart

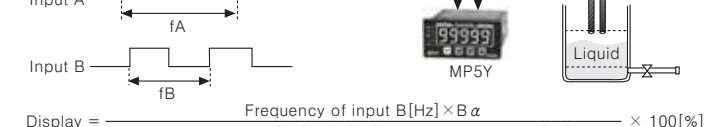

*Hold : Hold signal is ON, the display value will be held until hold signal is OFF.

●Mode F10(Error)

It displays the error between standard Input A and comparing Input B.

Error = Input B - Input A

$$\text{Error} = (\text{Frequency of input B}[\text{Hz}] \times B\alpha) - (\text{Frequency of input A}[\text{Hz}] \times A\alpha)$$

●Display value and display unit

Display value	Display unit
Error	END User setting unit

*Aα : Prescale of input A
*Bα : Prescale of input B

●Time chart

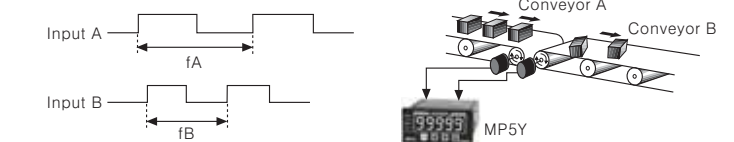

*Hold : Hold signal is ON, the display value will be held until hold signal is OFF.

●Mode F11(Length measurement)

It displays the number of Input A pulse while Input B is ON.

$$\text{Length measurement} = P \times \alpha \quad (*P : \text{Number of input A pulse, } \alpha : \text{Prescale value})$$

●Display value and display unit

Length measurement	Display unit
	Quantity[EA]
	mm
	cm
	m

*Factory default(Unit) : Quantity[EA]

●Time chart

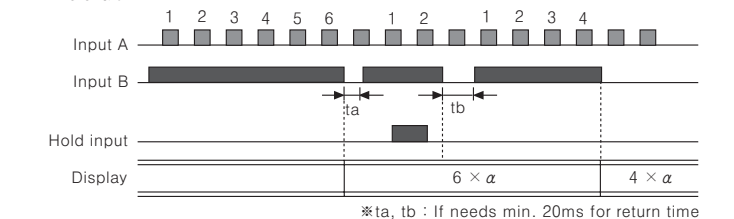

*ta, tb : If needs min. 20ms for return time

●Mode F12(Interval)

It displays the number of Input A pulse from Input B is ON to the time Input B is ON next.

$$\text{Interval} = P \times \alpha \quad (*P : \text{Number of input A pulse, } \alpha : \text{Prescale value})$$

●Display value and display unit

Length measurement	Display unit
	Quantity[EA]
	mm
	cm
	m

*Factory default(Unit) : Quantity[EA]

●Time chart

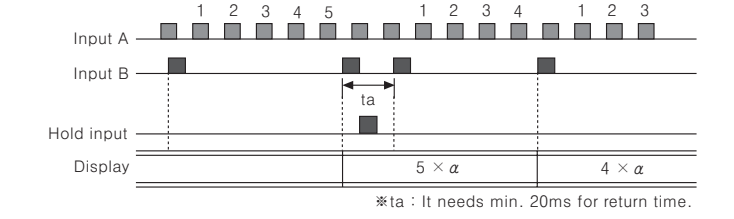

*ta : It needs min. 20ms for return time.

●Mode F13(Integration)

It displays the counting value against pulses of Input A.

$$\text{Integration} = P \times \alpha$$

*P : Pulse number of input A, alpha : Prescale value

●Display value and display unit

Display value	Display unit
Interval	Quantity[EA]

●Operation and Time chart

- ①It counts the number of input A pulse.
- ②As input B is an enable input signal it stops the counting and display value of input A when it is ON and then it counts input A continuously when it is OFF.
- ③If RESET input is ON, calculated counting value will be initialized.

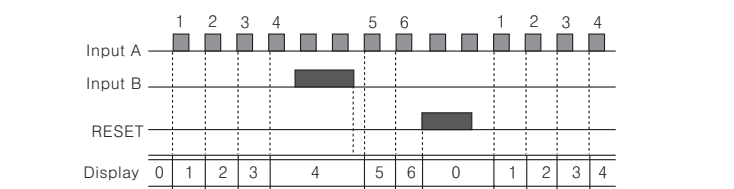

*alpha = 1 display value

Output mode

- Select output mode in **out-t** (Output type) of Parameter1 group.
- There are 5 stages output (HH, H, GO, L, LL).
- There are 6 kinds of output mode such as S (Standard) output mode, H (High) output mode, L (Low) output mode, B (Block) output mode, I (One shot) output mode, F (Deviation) output mode.
- The setting value (HH, H, L, LL) should be $LL < L < H < HH$ in B comparative output type and it operates individually not related to the setting value (HH, H, L, LL) in others output (S, H, L, I).

S (Standard) output mode [StAr-d]

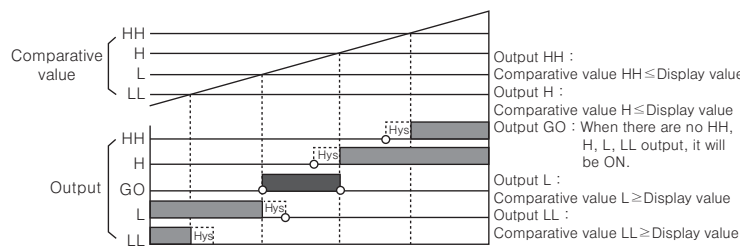

H (High) output mode [out-h]

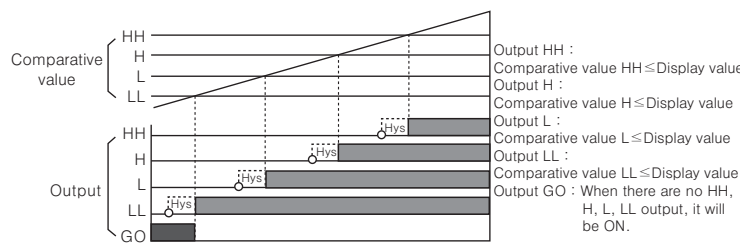

L (Low) output mode [out-L]

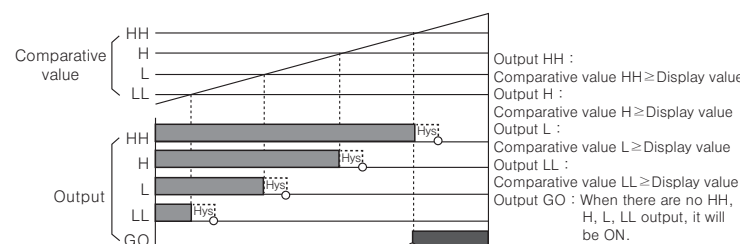

B (Block) output mode [out-b]

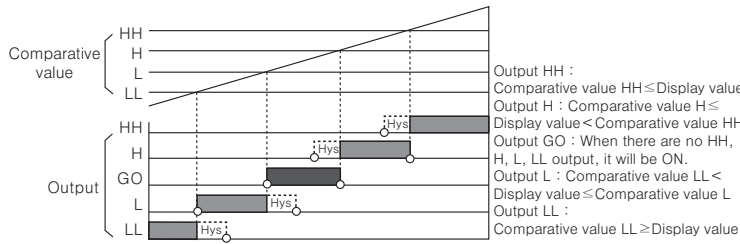

I (One Shot) output mode [out-I]

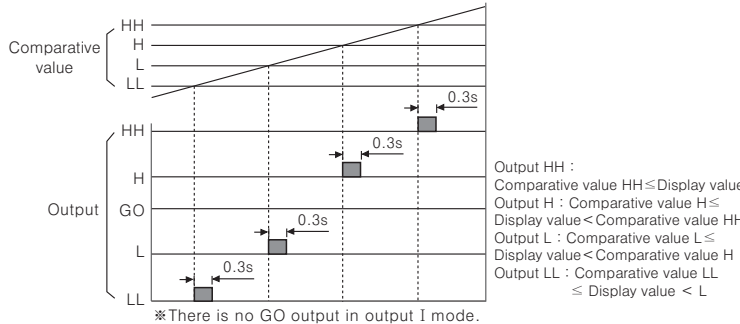

F (Deflection) output mode [out-F]

- This function is to memorize the setting value and provide outputs when it exceeds the deviation of H, L.
- The setting value memory : Memorize the current display value as the setting value by pressing (MD) + (▲) key in front.
 - Display the setting value : Check the memorized setting value by (▲) key. (Display the memorized setting value for pressing (▲) key continuously.)
 - Deviation setting : Set H (PSt.h), L (PSt.L) deviation by setting value.
 - (The set deviation will be memorized until set the next deviation again when power off.)
 - Deviation setting range : 0.0001 to 99999 (The setting range will be changed by decimal point setting parameter. If set decimal point as 0000.0, the setting range will be 0.1 to 9999.9.)

Operation

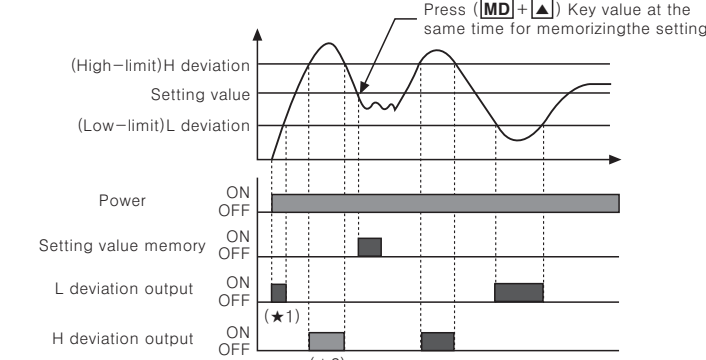

- (★1) When select the comparative output limit function, output will not be come.
- (★2) Output position may different from above graph as output coming under assuming the setting value memory is before the setting value memory point on above graph.
- There are no HH, GO, LL outputs in F output mode.
- Even though set the deviation as "0 (Zero)", it will actually work as 1 output mode.

Operation chart by each Parameter group

- The display parameter are different by each operation mode, please see "Parameter".
- : When select the operation mode, the parameter will be displayed.
- X : When select the operation mode, the parameter will not be displayed.

Parameter 0 group

Parameter 0	Sub mode	F1	F2	F3	F4	F5	F6	F7	F8	F9	F10	F11	F12	F13
PSt.hh		●	●	●	●	●	●	●	●	●	●	●	●	●
PSt.h		●	●	●	●	●	●	●	●	●	●	●	●	●
PSt.L		●	●	●	●	●	●	●	●	●	●	●	●	●
PSt.LL		●	●	●	●	●	●	●	●	●	●	●	●	●
h.PEK		●	●	●	●	●	●	●	●	●	●	●	●	X
L.PEK		●	●	●	●	●	●	●	●	●	●	●	●	X

Parameter 1 group

Parameter 1	Sub mode	F1	F2	F3	F4	F5	F6	F7	F8	F9	F10	F11	F12	F13
mode		●	●	●	●	●	●	●	●	●	●	●	●	●
In-A		●	●	●	●	●	●	●	●	●	●	●	●	●
In-b		X	●	X	X	X	●	●	●	●	●	●	●	●
out-t		●	●	●	●	●	●	●	●	●	●	●	●	X
hyS		●	X	X	X	X	X	●	●	●	●	X	X	X
GuAr.d	F.dEFy	●	●	●	●	●	●	●	●	●	●	●	●	X
	StAr.t	●	●	●	●	●	●	●	●	●	●	●	●	X
Auto.A		●	X	X	●	X	X	●	●	●	●	X	X	X
Auto.b		X	X	X	X	X	X	●	●	●	●	X	X	X
mEmo		X	X	X	X	X	X	X	X	X	X	X	X	●

*"●": IN-b sensor will be set as nPnhF or PnP.hF in mode F11, F12, F13.

Parameter 2 group

Parameter 2	Sub mode	F1	F2	F3	F4	F5	F6	F7	F8	F9	F10	F11	F12	F13
dot		●	●	X	X	X	X	●	●	●	●	●	●	●
t.unt		X	X	●	●	●	●	X	X	X	X	X	X	X
PSt.hh		●	●	●	●	●	●	●	●	●	●	●	●	●
PSt.h		●	●	●	●	●	●	●	●	●	●	●	●	●
PSt.L		●	●	●	●	●	●	●	●	●	●	●	●	●
PSt.LL		●	●	●	●	●	●	●	●	●	●	●	●	●
PSC.A.X (Note1)		●	●	X	●	X	X	●	●	●	●	●	●	●
PSC.A.y (Note1)		●	●	X	●	X	X	●	●	●	●	●	●	●
PSC.b.X		X	X	X	X	X	X	●	●	●	●	X	X	X
PSC.b.y		X	X	X	X	X	X	●	●	●	●	X	X	X
dISP.t		●	X	X	X	X	X	●	●	●	●	X	X	X

* (Note1) PSC. X, PSC. y are displayed in mode F1, F2, F4, F11, F12, F13.

Parameter 3 group

Parameter 3	Sub mode	F1	F2	F3	F4	F5	F6	F7	F8	F9	F10	F11	F12	F13	
FS-h		When it is PV retransmission output, it operates in all mode.													
FS-L		When it is RS485 communication output, it operates in all modes.													
Addr															
bPS															
remot															
LoC		●	●	●	●	●	●	●	●	●	●	●	●	●	

Monitoring delay operation function chart by each output mode

	out-t	StAr.d	out-h	out-L	out-b	out-I	out-F
Comparative output adjustment function.	●	X	X	●	X	●	●
Starting correction timer function	●	●	●	●	●	●	●

Parameter

Parameter 0 group

Menu and Parameter display	Parameter	Setting range	Setting key
PSt.hh → PSt.hh 99999	Set HH comparative value.	●F1, F2, F7, F9, F11, F12, F13 : 0 to 99999 ●F3 to F6 : 0 to Setting time range ●F8, F10 : -19999 to 99999	◀ : Move the setting digit ▶, ▲ : Change the setting value MD : Fix and move to the next parameter
PSt.h → PSt.h 99999	Set H comparative value.		
PSt.L → PSt.L 00000	Set L comparative value.		
PSt.LL → PSt.LL 00000	Set LL comparative value.		
h.PEK → h.PEK 99999	Display high peak value among measuring values	●Reset If you press ◀ key for 2sec. while h.PEK or L.PEK is flickering, the Peak value display will be reset to the current measuring value and it will keep flickering. If you touch once again, it will return to L.PEK or RUN.	
L.PEK → L.PEK -19999	Display low peak value among measuring values		

- (★1) If you press MD key in RUN mode, it will enter into PSt.hh (F output mode: PSt.h) at comparative output me and h.PEK at indication type.
- If pressing MD key for 2sec. in all setting, data will be saved then return to RUN mode. If no key is touched for 60sec., data will be held as previous value then return to RUN mode.
- When entering into parameter 0, the parameter name and data will be flickering by 1sec. then moving the setting digit and changing the setting value are available.
- It will show the set data to flicker by 1sec., then move to next parameter with touching MD key once.
- [] parameter is not shown in MP5Y-4N, MP5Y-43, MP5Y-44, MP5Y-45.

Parameter 1 group

Menu and Parameter display	Parameter	Setting range	Setting key
PAR.A.1 → PAR.A.1	This is parameter 1 group.		
nodE → nodE F1	Select operation mode.	F1 to F13	▶, ▲ : Change the setting mode → F1 → F2 to F13 MD : Fix and move to the next parameter
In-A → In-A nPnhF	Set the sensor type of input A.	● PNP transistor output type : PnP.hF ● Contact output type (L output) : PnP.L.F	▶, ▲ : Change the sensor type MD : Fix and move to the next parameter
In-b → In-b nPnhF	Set the sensor type of input B.	● NPN transistor output type : nPnh.F ● Contact output type (H output) : nPn.L.F	▶, ▲ : Change the sensor type MD : Fix and move to the next parameter
out-t → out-t StAr.d	Select the output mode.	StAr.d / out-h / out-L / out-b / out-I / out-F	▶, ▲ : Change the setting mode → StAr.d → out-h → out-L → out-F → out-I → out-b MD : Fix and move to the next parameter
hyS → hyS 0001	Set the hysteresis for the output. (★1)	0 to 9999 (If decimal point is set in 0000.0, the range will be 0 to 9999.)	◀ : Move the setting digit ▶, ▲ : Change the setting value MD : Fix and move to the next parameter
GuAr.d → GuAr.d F.dEFY / StAr.t	Select the start compensating timer function or comparative output L, LL limit function. (★2)	① F.dEFY / StAr.t ② When select StAr.t When [StAr.t] is flickering 999 by 1sec. cycle, set the starting correction time 0.0 to 999.	① ▶, ▲ : Change the setting mode → F.dEFY → StAr.t MD : Fix and move to the next parameter ② ◀ : Move the setting digit ▶, ▲ : Change the setting value MD : Fix and move to the next parameter
Auto.A → Auto.A 9999.9	Set the Auto-zero time of INA input.	0.1 to 9999.9	◀ : Move the setting digit ▶, ▲ : Change the setting value MD : Fix and move to the next parameter
Auto.b → Auto.b 9999.9	Set the Auto-zero of INB input.	0.1 to 9999.9	◀ : Move the setting digit ▶, ▲ : Change the setting value MD : Fix and move to the next parameter
ñEñO → ñEñO off	It sets the memory retention. The measuring value will be memorized when the power off. (Mode F13 only)	on : Memory retention off : No memory retention	▶, ▲ : Change the setting mode → on → off MD : Fix and move to the next parameter nodE.

- If press MD key for 3 sec. in RUN, it will enter parameter 1 group.
- The output mode is fixed as out-h type in F13 operation mode.
- (★1) Hysteresis operation mode is able to be set in F1, F7 to F10 operation mode.
- (★2) You are able to select the comparative output [F.dEFY] limit function or starting correction [StAr.t] timer in monitoring delay function mode.
- When selecting the comparative output limit [F.dEFY] function, it will move to the next parameter [Auto.A] and when selecting the starting correction timer [StAr.t] you need to be set the starting correction time [0.0 to 999] so that it moves to the next parameter [Auto.A]
- When entering into parameter 1 group, the parameter name and data will be flickering by 1 sec. then move setting digit by ◀ key or change the setting value by ▶, ▲ key.
- All data set by users will be shown [displayed] to 1sec. cycle then move to the next parameter by pressing MD key.
- If press MD key for over 2 sec. in every setting mode, data will be set and return to RUN and if you don't use the for 60sec. data will be remained and return to RUN.
- [] parameter is not shown in MP5Y-4N, MP5Y-43, MP5Y-44, MP5Y-45.

Parameter 2 group

Menu and Parameter display	Parameter	Setting range	Setting key												
<p>After displaying PAR.A.2 for 2sec. then advance to PbAR.2 automatically. Pressing MD key before 1sec. it will move to PbAR.2.</p> <p>dot → 00000</p> <p>t.un → t.SEC → t.n → t.n</p> <p>t.SEC → 99999 → t.n → 99999</p> <p>PSt.hh → 99999</p> <p>PSt.h → 99999</p> <p>PSt.L → 00000</p> <p>PSt.LL → 00000</p> <p>PSC.AH → 1.0000</p> <p>PSC.AY → 10 00</p> <p>PSC.bH → 1.0000</p> <p>PSC.bY → 10 00</p> <p>dI SP.t → dI SP.t</p>	<p>This is parameter 2 group.</p> <p>Set decimal point position of display value</p> <p>It will be displayed in F3, F4, F5, F6 operation mode and set the time unit. (★1)</p> <p>① Select the time unit ② Select time range</p> <p>Set the comparative value HH.</p> <p>Set the comparative value H.</p> <p>Set the comparative value L.</p> <p>Set the comparative value LL.</p> <p>Set the prescale value of input A mantissa(X).</p> <p>Set the prescale value of input A an exponent(y).</p> <p>Set the prescale value of input B mantissa(X).</p> <p>Set the prescale value of input B an exponent(y).</p> <p>Select the display cycle.</p>	<p>00000 00000 0000.0 0000.0 000.00 000.00</p> <table border="1"> <thead> <tr> <th>SEC</th> <th>MIN</th> </tr> </thead> <tbody> <tr> <td>999.99sec.</td> <td>999.99min.</td> </tr> <tr> <td>9999.9sec.</td> <td>9999.9min.</td> </tr> <tr> <td>99min.59.9sec.</td> <td>99hour59.9min.</td> </tr> <tr> <td>9hour59min.59sec.</td> <td>999hour59min.</td> </tr> <tr> <td>99999sec.</td> <td>99999min.</td> </tr> </tbody> </table> <p>00000 to 99999</p> <p>10 - 9 to 10 9 (10⁻⁹ to 10⁹)</p> <p>00000 to 99999</p> <p>10 - 9 to 10 9 (10⁻⁹ to 10⁹)</p> <p>0.05, 0.5, 1, 2, 4, 8</p>	SEC	MIN	999.99sec.	999.99min.	9999.9sec.	9999.9min.	99min.59.9sec.	99hour59.9min.	9hour59min.59sec.	999hour59min.	99999sec.	99999min.	<p>◀ : Move the decimal point ▶ : Fix and move to the next parameter</p> <p>① ▼, ▲ : Change the setting mode MD : Save → t.SEC → t.n</p> <p>② ▼, ▲ : Change the setting value MD : Fix and move to the next parameter</p> <p>◀ : Move the setting digit ▶ : Move the setting digit</p> <p>▼, ▲ : Change the setting value MD : Fix and move to the next parameter</p> <p>◀ : Move the setting digit ▶ : Move the setting digit</p> <p>▼, ▲ : Change the setting value MD : Fix and move to the next parameter</p> <p>◀ : Move the setting digit ▶ : Move the setting digit</p> <p>▼, ▲ : Change the setting value MD : Fix and move to the next parameter</p> <p>▼, ▲ : Change setting value MD : Fix and move to the next parameter</p>
SEC	MIN														
999.99sec.	999.99min.														
9999.9sec.	9999.9min.														
99min.59.9sec.	99hour59.9min.														
9hour59min.59sec.	999hour59min.														
99999sec.	99999min.														

- It will enter into parameter 3 if pressing **MD** key for 5sec in **RUN** mode.
- (★1) It is able to select second [t.SEC] or minute [t.n] in time until selection parameter [t.un]. then also selectable time range.
- When enter into the parameter 2 group, the parameter name and data value will flicker by cycle (1sec.). Then move the setting digit by **◀** key and change the setting value by **▼/▲** key.
- The fixed data value set by user in each parameter will flicker by cycle (1sec.) and move to the next parameter by pressing **MD** key.
- If press **MD** key for over 2 sec. in every setting mode, data will be set and return to **RUN**.
- [] parameter is not shown in MP5Y-4N, MP5Y-43, MP5Y-44, MP5Y-45.

Parameter 3 group

Menu and Parameter display	Parameter	Setting range	Setting key
<p>Display PAR.A.3 for 2sec. then move to F5-h automatically. Move to F5-h, if press MD key 1sec. before.</p> <p>F5-h → 99999</p> <p>F5-L → 00000</p> <p>Addr → 00</p> <p>bPS → 2400</p> <p>rEnot → oFF</p> <p>LoC → oFF</p>	<p>This is parameter 3 group.</p> <p>Set the High-limit value of PV transmission output.</p> <p>Set the Low-limit value of PV transmission output.</p> <p>Set the communication Address.</p> <p>Select the communication speed.</p> <p>Select the Remote and the Local. (★1)</p> <p>Enable to lock the key for each parameter group</p>	<p>●F1, F2, F7, F9, F11, F12, F13 : 0 to 99999</p> <p>●F3, F6 : 0 to Setting time range</p> <p>●F8, F10 : -19999 to 99999</p> <p>00 to 99 (32 channel)</p> <p>2400 / 4800 / 9600</p> <p>on : Use oFF : Not use</p> <p>oFF : There is no key lock in all mode</p> <p>LoC.0 : P0 to 3 Lock LoC.1 : P1 to 3 Lock LoC.2 : P2 to 3 Lock LoC.3 : P3 Lock only</p>	<p>◀ : Move the setting digit ▶ : Change the setting value MD : Fix and move to the next parameter</p> <p>◀ : Move the setting digit ▶ : Change the setting value MD : Fix and move to the next parameter</p> <p>▼, ▲ : Change the setting value MD : Fix and move to the next parameter</p> <p>▼, ▲ : Change the setting mode MD : Fix and move to the next parameter</p> <p>▼, ▲ : Change the setting mode MD : Fix and move to the next parameter</p>

- It will enter into parameter 3 if pressing **MD** key for 5sec in **RUN** mode.
- (★1) It is able to set the remote or local function in communication output type. When select the remote [rEnot] function, the front keys are disabled.
- (★2) Pressing **MD** key at parameter 3, it will enter into **F5-h** or **Addr** (option function), **LoC** (indication type only).
- When entering into the parameter 3 group, the parameter name and data value will flicker by cycle (1sec.). Then move the setting digit by **◀** key and change the setting value by **▼/▲** key.
- The fixed data value by user in each parameter will flicker by cycle (1sec.) and move to the next parameter by pressing **MD** key.
- If press **MD** key for over 2 sec. in every setting mode, data will be set and return to **RUN** mode then if no key is touched for 60sec. data will be held as previous value and return to **RUN** mode.

Function

Prescale function



- Prescale value (α = 15) setting
Set prescale value (α) as mantissa (X) and exponent (Y) at **PSC.AH**, **PSC.AY** (**PSC.bH**, **PSC.bY**) of parameter 2 group.
Prescale value (α) = 15 → Mantissa (X): 1.5000, Exponent (Y): 10¹
And also it is able to set α value as X=0.1500, Y=10² then get the same display value.
* Display cycle can be selected at parameter 2 group.

Display Peak value monitoring function

- This is to monitor max. value and min. value by current display value, and display that Data at **hPEL/LPEL** mode of parameter 0 group.
- User can check saved value in parameter 0 group. And High Peak (**hPEL**) value or Low Peak (**LPEL**) will be continuously saved during checking.
- See Parameter 0 for Reset.

Hysteresis function

- Set the Hysteresis value (A) for comparative setting value in order to prevent unstable operation due to output going ON/OFF frequently.

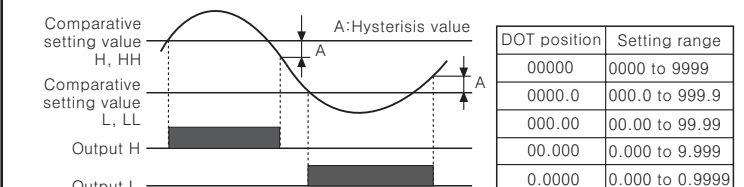

- You are able to set "0", but when set "0", the actual operation will be as "1".
- The initial setting value is 0001.
- You are able to set in the Parameter 1 group.

Monitoring delay time function

- This function is for the stable control to limit LLL outputs until certain output is come or to limit all outputs during the equipment is reaching a stable status against various change of input such as the starting current when the motor is running after power on. There are no the starting correction timer function and comparative output limit function in the monitoring delay function. (Select in **GuAr.d** mode of parameter 1 group)
- The starting correction timer function (Parameter 1 group **StAr.t** mode)
- This function is to make the output not come out during the setting time. (Time setting range 0.0 to 99.9sec)

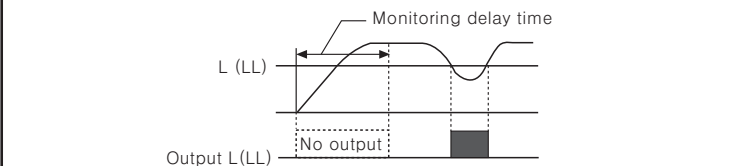

Comparative output limit function (Parameter 1 group **FdEFY** mode)

- Applicable output mode: S, B, F output mode
- This function is to limit the LL, L output before H or HH output.

1) The output mode is S output mode

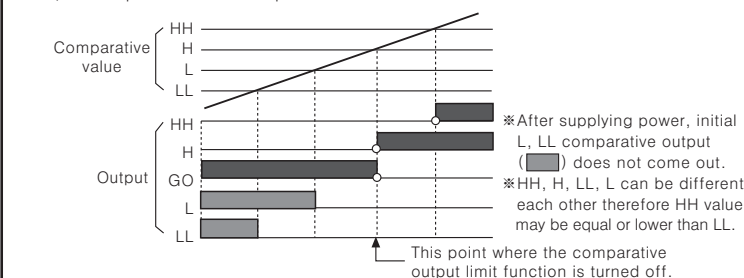

2) The output mode is B output

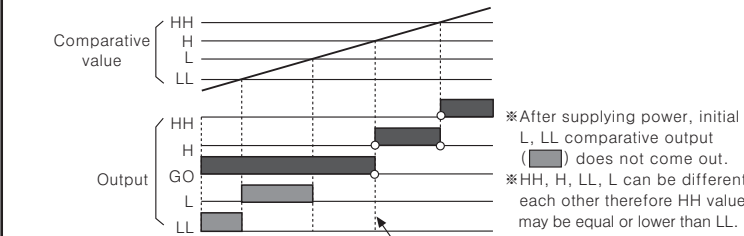

3) The output mode is F output mode

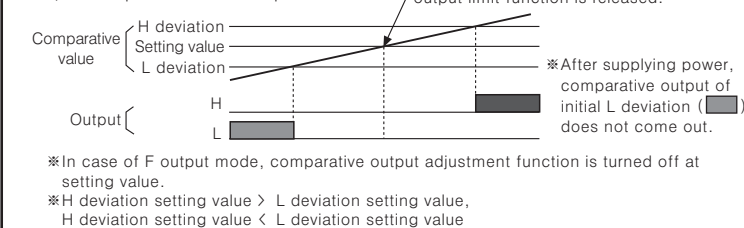

Auto-Zero time setting function

- When you know the interval of input signal, Auto-zero time should be set as a little bit longer than that interval of input signal. If there is no pulse input within setting time (Auto-zero time), it regards as the input signal is cut off then make the value as "00000" forcibly. Note that the Auto-zero time setting should be longer than the narrowest interval of input pulse. Otherwise it may be difficult to make the display value as "00000".
- Auto-zero time setting range (0.1 to 9999.9sec)
- When the display value is "00000", each output will be come against "0".
- Auto-Zero time setting is available in parameter 1 group.

Lock setting function

- This function is to set the enable or disable of each Parameter and mode changes in MP5Y.
- Off : No lock function
- LoC 0 : P0 to P3 Lock (Lock from Parameter 0 to Parameter 3)
- LoC 1 : P1 to P3 Lock (Lock from Parameter 1 to Parameter 3)
- LoC 2 : P2 to P3 Lock (Lock from Parameter 2 to Parameter 3)
- LoC 3 : P3 Lock (Lock Parameter 3 only)
- Lock setting is available in parameter 3 group.

Inner hardware Lock setting function

- This function is to lock **LoC** in Parameter 3 group by Inner hardware Lock mode in order to prevent wrong setting.
- h0 (Hardware Lock0) : Enable to check and change the **LoC** mode in parameter 3 group.
- h1 (Hardware Lock1) : Enable to check the **LoC** mode only in parameter 3 group. But it is not possible to change the parameter.
- h2 (Hardware Lock2) : Enable to check and change the **LoC** mode in parameter 3 group
- It is possible to lock or unlock after supplied power in Inner hardware Lock setting.

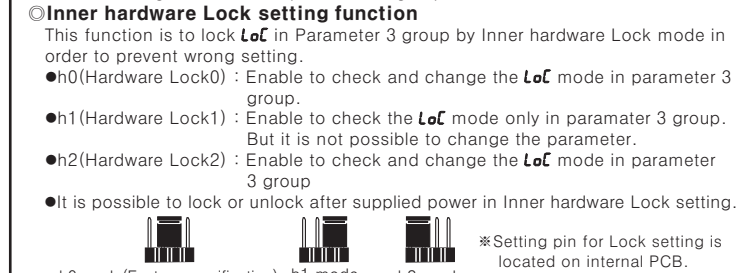

Display cycle selection function

- This function is to change the display cycle in range of 0.05/0.5/1/2/4/8 sec., and displays the average value of measuring value for the setting cycle.

Time unit selection function

- Enable to display PV value with firmed time unit in range of various time.
 - Time unit selection function can be set in parameter 2 group.
 - Applicable mode : Mode 3 to 6
 - There is no DOT setting mode when set the time unit display function.
- | SEC | MIN |
|-------------------|----------------|
| 999.99sec. | 999.99min. |
| 9999.9sec. | 9999.9min. |
| 99min.59.9sec. | 99hour59.9min. |
| 9hour59min.59sec. | 999hour59min. |
| 99999sec. | 99999min. |

Factory default

Mode	Setting value	Mode	Setting value	Mode	Setting value	Mode	Setting value
F5-h	99999	dot	00000	PSt.LL	00000	nodE	F 1 hYS 000 1
F5-L	00000	PSt.h	99999	PSC.H	6.0000	I n-R nPnhFGuAr.dFdEFY	oUt-tStAr.dAutAR 99999
Addr	00	PSt.L	00000	dI SP.t	005		
bPS	2400						
rEnot	oFF						
LoC	oFF						

* The specification may not be displayed due to the operation mode and output specification.

Caution for using

- Installation environment
 - If shall be used indoor
 - Altitude Max. 2000m
 - Pollution Degree 2
 - Installation Category II.
 - Please use separated line from high voltage line or power line in order to avoid inductive noise.
 - Please install power switch or circuit breaker in order to cut the power supply.
 - The switch or circuit breaker should be installed near by users for safety.
 - Do not use this unit at below places.
 - Place where there are severe vibration or impact.
 - Place where there are direct ray of the sun.
 - Place where strong magnetic field or electric noise are generated.
 - Storage method
When storing this unit for a long time, please avoid the direct ray of the sun and keep this unit under circumstances as -20 to +60°C, 35 to 85RH.
 - Input line
Shield wire must be used when the measuring input line is getting longer or there are lots of noises.
 - Using shield with two wires
 - Please put enough space between power line and terminal of measuring input.
- It may cause malfunction if above instructions are not followed.**

Main products

- COUNTER
- TIMER
- TEMPERATURE CONTROLLER
- PANEL METER
- TACHO/LINE SPEED/PULSE METER
- DISPLAY UNIT
- PROXIMITY SENSOR
- PHOTOELECTRIC SENSOR
- FIBER OPTIC SENSOR
- PRESSURE SENSOR
- ROTARY ENCODER
- SENSOR CONTROLLER
- POWER CONTROLLER
- STEPPING MOTOR & DRIVER & CONTROLLER
- LASER MARKING SYSTEM

ООО "РусАвтоматизация"

454010 г. Челябинск, ул. Гагарина 5, оф. 507
 тел. 8-800-775-09-57 (звонок бесплатный),
 тел.: (351)799-54-26, тел./факс (351)211-64-57
 info@rusautomation.ru; www.rusautomation.ru
 русавтоматизация.рф