



Operating Manual

OM20/OM30 IO-Link
Laser distance sensor

EN-US

List of contents

1 About this document	4
1.1 Purpose.....	4
1.2 Warnings in this manual.....	4
1.3 Labels in this manual	5
1.4 Liability limitation	5
1.5 Name plate.....	5
1.6 Scope of delivery.....	6
2 Safety.....	7
2.1 Personnel requirements	7
2.2 General information.....	7
2.3 Laser	8
3 Description.....	9
3.1 Structure.....	9
3.2 General functionality	9
3.3 Measurement field.....	10
3.4 Operating and display elements.....	11
3.4.1 Sensor LEDs.....	11
3.4.2 Teach button	11
3.5 Analog measurement performance.....	13
3.5.1 Interpretation of the characteristic curves.....	13
3.6 IO-Link.....	14
3.7 Dimensional drawing.....	17
4 Transport and storage	18
4.1 Transport.....	18
4.2 Delivery inspection	18
4.3 Storage.....	18
5 Installation instructions.....	19
6 Electrical installation	22
6.1 Pin assignment.....	22
6.2 Connection diagram	22
6.3 Connecting the sensor to electricity	22
7 Commissioning	23
7.1 Factory settings.....	23
7.2 Setting up IO-Link	23
8 Functions	24
8.1 Filter	24
8.2 Trigger mode.....	27

8.3	Zero position	28
8.4	Measurement range	28
8.5	Invalid Value Handling	29
8.6	Switching points	31
8.7	Polarity	32
8.8	Hysteresis	33
8.9	Function of the output	36
8.10	Analog measurement field	36
8.11	Function of the Teach button	38
9	Diagnostic data.....	39
9.1	Measurement rate	39
9.2	Response delay	40
9.3	Exposure reserve	40
9.4	Signal quality	41
9.5	Device status.....	41
9.6	Operating time.....	41
9.7	Histogram function	42
10	Preventive maintenance	45
10.1	Cleaning the sensor	45
11	Troubleshooting	46
11.1	Return and repair	46
11.2	Accessories	46
12	Annex	47
12.1	Analog output resolution - diagrams	47

1 About this document

1.1 Purpose

This operating manual (subsequently referred to as *manual*) allows the safe and efficient handling of the product .

The manual does not provide instructions on operating the machine in which the product is integrated. Information on this is found in the operating manual of the machine.

The manual is a constituent part of the product. It must be kept in the immediate vicinity of the product and must be accessible to personnel at all times.



Personnel must have carefully read and understood this manual before beginning any work. The basic prerequisite for safe working is compliance with all safety instructions and handling instructions given in this manual.

In addition, the local occupational health and safety regulations and general safety regulations apply.

The illustrations in this manual are examples only. Deviations are at the discretion of Baumer at all times.

1.2 Warnings in this manual

Warnings draw attention to injury or material damage. The warnings in this manual indicate different hazard levels:

Symbol	Warning term	Explanation
	DANGER	Indicates an immediate danger with high risk that will lead to death or serious injury if not avoided.
	WARNING	Indicates a possible danger with medium risk that may lead to death or (serious) injury if not avoided.
	CAUTION	Indicates a danger with low risk that could lead to slight or medium injury if not avoided.
	NOTE	Indicates a warning of material damage.
	INFO	Indicates practical information and tips that enable optimal use of the devices.

1.3 Labels in this manual

Identifier	Use	Example
<i>Dialog element</i>	Indicates dialog elements.	Click the OK button.
<i>Unique name</i>	Indicates the names of products, files, etc.	<i>Internet Explorer</i> is not supported in any version.
Code	Indicates entries.	Enter the following IP address: 192.168.0.250

1.4 Liability limitation

All information and notes in this manual have been compiled in accordance with the applicable standards and regulations, the state of the art, and our many years of knowledge and experience.

The manufacturer accepts no liability for damage due to the following reasons:

- Non-observance of the manual
- Improper use
- Use of unqualified personnel
- Unauthorized conversions

The obligations agreed in the delivery contract, the general terms and conditions and the delivery conditions of the manufacturer and its suppliers, as well as the legal regulations valid at the time of conclusion of the contract apply.

1.5 Name plate

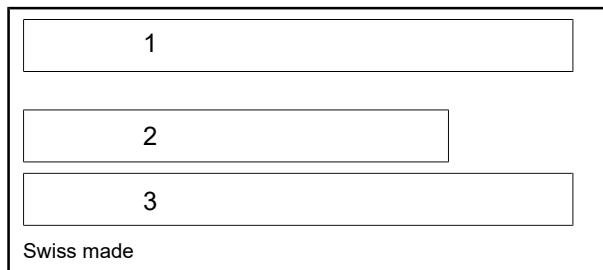

///. 1: Name plate

1	Short item name (OMxx item number)	2	Production date
3	Serial number		

1.6 Scope of delivery

The scope of delivery includes:

- 1 x sensor
- 1 x quickstart
- 1 x General information leaflet

In addition, you can find the following information, among other things, in digital format at www.baumer.com:

- Operating manual
- Data sheet
- 3D CAD drawing
- Quickstart
- Dimensional drawing
- Connection diagram & pin assignment
- IODD file
- Certificates (EU conformity declaration, etc.)

2 Safety

2.1 Personnel requirements

Certain work with the product may only be carried out by specialized personnel.

Specialized personnel are staff members who can evaluate the tasks assigned to them and recognize potential danger, based on their training and work as well as a reliable understanding of technical safety issues.

Qualified personnel are divided into the following categories:

- **Instructed personnel:**

A person who has been informed and, if required, trained, by a specialist about the assigned tasks and potential dangers of improper behavior.

- **Specialist:**

A person who, based on his/her training, experience, and instruction, as well as his/her knowledge of applicable standards, rules, and accident prevention regulations, has been authorized to carry out the respectively required tasks, while recognizing and avoiding potential dangers.

- **Electrical specialist:**

A person with the appropriate specialist training, knowledge, and experience allowing him/her to recognize and avoid dangers originating from electricity.

2.2 General information

Intended use

This product is a precision device and serves the detection of items, objects, or physical measurement variables and the preparation or provision of measured values as electric variables for the higher-level system.

Unless specifically labeled, this product may not be used in explosive environments.

Commissioning

Assembly, installation, and calibration of this product may only be performed by a specialist.

Installation

Only use the fasteners and fastener accessories intended for this product for installation. Outputs not in use must not be wired. Unused wires of cable outputs must be insulated. Do not go below the permissible cable bending radii. Disconnect the system from power before the product is electrically connected. Use shielded cables to prevent electro-magnetic interference. If the customer assembles plug connections on shielded cables, then EMC-version plug connections should be used and the cable shield must be connected to the plug housing across a large surface area.

Disposal (environmental protection)



Used electrical and electronic devices may not be disposed of in household waste. The product contains valuable raw materials that can be recycled. Therefore dispose of this product at the appropriate collection point. For additional information visit www.baumer.com.

2.3 Laser



CAUTION

Use of controls or adjustments of performance of procedures other than those specified herein may result in hazardous radiation exposure. For a detailed description of the radiation pattern emitted by a particular device, refer to the data sheet of the respective device.

CLASS 1 LASER PRODUCT

IEC 60825-1/2014

Complies with 21 CFR 1040.10 and 1040.11 except for conformance with IEC 60825-1 Ed. 3., as described in Laser Notice No. 56, dated May 8, 2019

Products with the following type codes are rated as Laser Class 1:

OM20-xxxxx.HH.xxx

OM30-xxxxx.HH.xxx

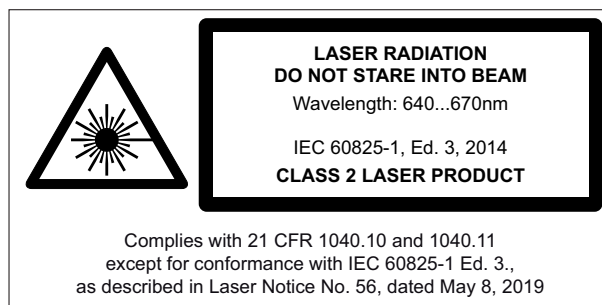

Products with the following type codes are rated as Laser Class 2:

OM20-xxxxx.HV.xxx

OM30-xxxxx.HV.xxx

3 Description

3.1 Structure

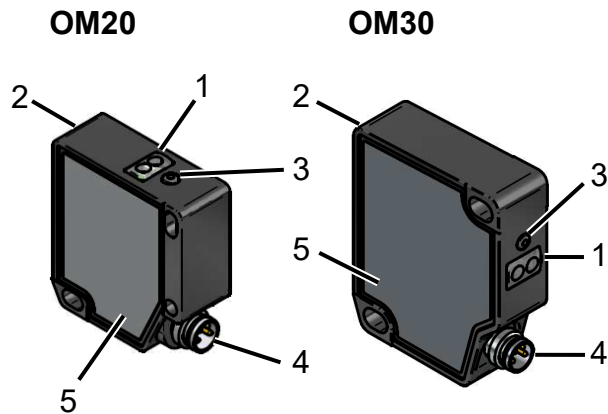

III. 2: Structure OM20/OM30

1	Sensor LEDs	2	Front panel
3	Teach button	4	M8 plug, 4-pin
5	Imprint of laser information & name plate		

3.2 General functionality

The sensor measures the distance to an object to be measured by angle calculation (triangulation principle). For this purpose, the sensor projects a laser point on the object to be measured. This laser point is mapped on the receiver element by the receiving optics. The distance to the object to be measured is calculated from the location of the image on the receiver element. The measured distance is provided as a measured value via the following channels integrated in the sensor:

- Digital IO-Link interface
- Analog output

The following options are available to you for parameterizing the sensor:

- IO-Link parameter
- Teach button on the sensor

3.3 Measurement field



INFO

The data for your sensor version can be found in the data sheet.

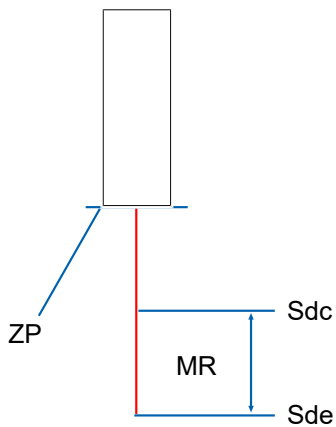

ZP	Zero position	MR	Measuring range
Sdc	Start of the measuring range	Sde	End of the measuring range

Measuring range (MR)

- Region in which the measurement object must be present for the sensor to deliver reliable measurement results.
- Unwanted objects (objects not to be measured) in this region may lead to deviations in the measurement results.
- The limits of the measurement range (MR) are defined via the parameters *Start of the measurement range (Sdc)* and *End of the measurement range (Sde)*.

Zero position (ZP)

- In the factory settings, the zero point is located on the front of the sensor ($ZP = 0 \text{ mm}$). The output consists of the distance between the front of the sensor and the measurement object.
- The following values depend on the zero position:
 - Output measured values
 - Analog value
 - Switching points
- Capable of parameterization via:
 - IO-Link
 - Teach button

3.4 Operating and display elements

3.4.1 Sensor LEDs

Des.		Illuminated	Blinking
POWER	Green	Sensor ready for operation	-
OUTPUT	Yellow	No valid signal within the measurement range	Critical signal quality

In the factory settings, the **OUTPUT** (pin 4), and thus also the yellow LED, follows the function of the alarm output. Alternatively, you can select the function of the switching output for the **OUTPUT** and the yellow LED.

3.4.2 Teach button

Instead of parameterizing the sensor via the IO-Link, you can configure the sensor via the Teach button. Adjustable parameters:

- Analog measurement field
- Zero position
- Resetting the sensor to the factory settings



INFO

You have the additional option of adjusting the mode of the Teach button via IO-Link. You have a choice between *Xpert* (factory setting) and *Xpress* mode. For more information, see [Function of the Teach button \[▶ 38\]](#).

The teach button is automatically deactivated after 5 min (the timeout can be parameterized via IO-Link). When the teach button is pressed for longer than 12 seconds, the sensor enters operating mode without performing a parameterization.

Parameterization via the Teach button is done according to the procedure described in the following.

Teaching the analog measurement field

Instruction:

- a) Press the teach button briefly.
 - ✓ Green and yellow LEDs light up (teach button is active). If the LEDs do not light up, start the sensor again.
- b) Keep the teach button pressed for 4 seconds.
 - ✓ Yellow LED blinks with 2 Hz.
- c) Place the measurement object on position 1 (P1) and briefly press the teach button within 60 seconds.
 - ✓ The min. limit of the analog measurement range has been taught in (distance at which the min. voltage or min. current is displayed).
- d) Place the measurement object on P2 and briefly press the teach button within 60 seconds.
 - ✓ The max. limit of the analog measurement range has been taught in (distance at which the max. voltage or max. current is displayed).

Result:

- ✓ Teach-in OK: Green and yellow LEDs light up briefly. Afterwards, the sensor returns to operating mode.
- ✓ Teach-in not OK: Green and yellow LEDs blink simultaneously with 8 Hz.

NOTICE

The characteristic curve of the analog output can be inverted by the teaching process (negative gradient). To do this, teach in the maximum distance for P1 and the minimum distance for P2.

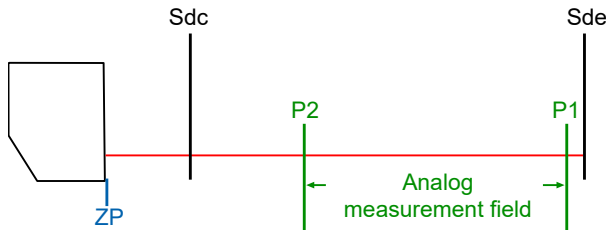

III. 3: Analog measurement field (inverted)

Teaching the zero position

- a) Press the teach button briefly.
 - ✓ Green and yellow LEDs light up (teach button is active). If the LEDs do not light up, start the sensor again.
- b) Keep the teach button pressed for 2 seconds.
 - ✓ Green LED blinks with 2 Hz.
- c) Place the measurement object on the desired position for the zero point and briefly press the teach button within 60 seconds.

Result:

- ✓ Teach-in OK: Green and yellow LEDs light up briefly. Afterwards, the sensor goes back to operating mode.
- ✓ Teach-in not OK: Green and yellow LEDs blink simultaneously with 8 Hz.

After the zero point is shifted,

- the digital measured values before the zero point (in the direction of the sensor) are output as negative and those after the zero point are output as positive measured values.
- the limits of the analog measurement field have shifted. Therefore, parameterize the analog measurement field again.

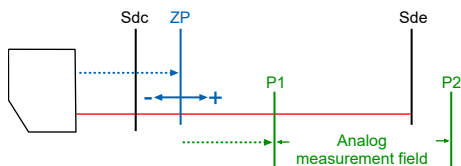
**Resetting to the factory settings**

- a) Press the teach button briefly.
 - ✓ Green and yellow LEDs light up (teach button is active). If the LEDs do not light up, start the sensor again.
- b) Keep the teach button pressed for 8 seconds.
 - ✓ Yellow and green LEDs blink simultaneously with 2 Hz.

Result:

- ✓ Teach-in OK: Green and yellow LEDs light up briefly. Afterwards, the sensor goes back to operating mode.
- ✓ Teach-in not OK: Yellow and green LEDs blink simultaneously with 8 Hz.

3.5 Analog measurement performance

The sensor's analog output features 12-bit resolution. Such resolution may limit the precision of the analog current or voltage values. For this reason, the analog measuring field should be restricted to the measuring range relevant for the application. This can be done via the teach button or the IO-Link interface.



INFO

For all laser distance sensors, the precision decreases with increasing measuring distance. For this reason, the resolution of the analog output limits the repeatability of the analog measurement results, especially at close range.

- a) To achieve the highest possible precision, measure in the close range of the sensor and limit the analog measuring field to as small an area as possible.

Also see about this

[Analog measurement field \[▶ 36\]](#)

[Teach button \[▶ 11\]](#)

3.5.1 Interpretation of the characteristic curves

The diagrams in the appendix of this documentation show how the resolution of the analog output limits the precision of the measurement.

Example

In this example, the repeatability of the sensor is specified as 1 μm at the beginning of the measuring range to 3 μm at the end of the measuring range. This precision can be achieved at the analog output by narrowing the analog measuring field to 3 mm.

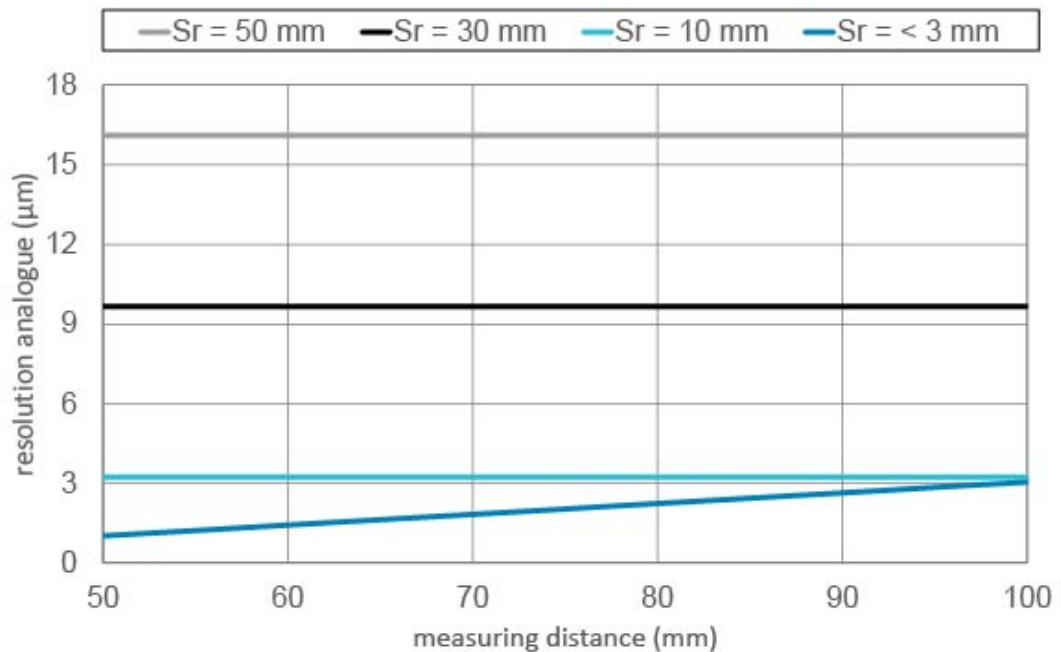

The following statements can be derived from the graph:

- No containment of the analog output (i.e. $S_r = 50$ mm - gray characteristic line) limits the precision at the analog output to $16\ \mu\text{m}$.
- However, if the analog measuring range is narrowed down to 3 mm or smaller (dark blue characteristic curve), the best possible precision of the sensor can be achieved at any distance in the measuring range. This is $1\ \mu\text{m}$ to $3\ \mu\text{m}$.

Interpretation in detail

1. Analog measuring field = 50 mm:
If the analog measuring field is not restricted, the resolution of the analog output limits the repeatability of the sensor to $16\ \mu\text{m}$. The gray characteristic curve shows the limitation of the performance.
2. Analog measuring field = 30 mm:
If the analog measuring field is limited to 30 mm, the resolution of the analog output limits the repeatability of the sensor to $10\ \mu\text{m}$. The black characteristic curve shows the limitation of the performance.
3. Analog measuring field = 10 mm:
If the analog measuring field is limited to 10 mm, the resolution of the analog output limits the repeatability of the sensor to $3\ \mu\text{m}$. The light blue characteristic curve shows the limitation of the performance.
4. Analog measuring field = < 3 mm:
If the analog measuring field is restricted to < 3 mm measuring range, the resolution of the analog output over the entire measuring range does not limit the repeatability. The dark blue characteristic curve shows the best possible repeatability from $1\ \mu\text{m}$ to $3\ \mu\text{m}$ of the sensor.

Also see about this

 [Analog output resolution - diagrams](#) [▶ 47]

3.6 IO-Link

The IO-Link distinguishes between the following types of data:

- Process data
- Parameter
- Diagnostic data

Process data

Process data are cyclical data that are transmitted in the IO-Link communication mode with each query cycle. An explicit query of the data is not necessary. The following process data are available for the sensor:

- Output:
 - Find me (localizing the sensor by activating the LEDs)
 - Laser on/off
- Input:
 - Measured value
 - Scale of the measured value
 - Status of the alarm output
 - Status of the signal quality
 - Status of the switching output

IO-Link process data: Output

Sub-Index	Bit-Offset	Denotation	Data type	Description
1	1	Find me	Boolean	<ul style="list-style-type: none"> Localize the sensor by activating the LEDs.
2	0	Laser ON/ OFF	Boolean	<ul style="list-style-type: none"> Switch the laser on/off.

IO-Link process data: input

Sub-Index	Bit-Offset	Denotation	Data type	Description
1	16	Distance (MDC)	32 Bit Integer	<ul style="list-style-type: none"> Measured value
2	8	Scale	8 Bit Integer	<ul style="list-style-type: none"> Scale of the measured value The transmitted scale value corresponds to exponents of 10 (i.e.: 10^{Scale}). Formula for calculating the measurement value: <ul style="list-style-type: none"> Measurement value (MDC¹) $\times 10^{\text{Scale}} \times \text{Unit}$ Example: <ul style="list-style-type: none"> Measurement value (MDC): 1000 Scale: -6 Unit: m Therefore: $1000 \times 10^{-6} \times \text{m} = 1000 \mu\text{m}$
7	3	Output	Boolean	<ul style="list-style-type: none"> Status of the alarm output <ul style="list-style-type: none"> Bit 3 = 0: Alarm is inactive. Sensor is functioning as required. Bit 3 = 1: Alarm is active. The sensor must be checked. No measured value can be recorded.
8	2	Quality Bit	Boolean	<ul style="list-style-type: none"> Status of the signal quality. <ul style="list-style-type: none"> Bit 2 = 0: Signal quality is sufficient for a valid measurement. Bit 2 = 1: Signal quality is insufficient. The sensor must be checked (e.g. for soiling).
10	0	SSC1 (Switching Signal Channel 1)	Boolean	<ul style="list-style-type: none"> Status of the switching output. <ul style="list-style-type: none"> Bit 0 = 0: Switching output is inactive. Bit 0 = 1: Switching output is active.

¹ MDC = Measurement Data Channel

Parameter

Parameters are acyclic data (transmission occurs as needed). The following parameters are available for the sensor:

- Filters for smoothing the signal characteristics
- Triggers for recording the measured value
- Processing of invalid measured values
- Switching points
- Polarity (output level of the switching output)
- Hysteresis
- Zero position
- Limits of the measurement range
- Limits of the analog measurement field
- Output & LED (alarm/switching output)
- Configuration of the Teach button

Diagnostic data

The diagnostic data is used for monitoring the status of the device. The following diagnostic data is available for the sensor:

- Measurement rate
- Reply delay
- Exposure reserve
- Signal quality
- Device status
- Operating time
- Histogram function

For a detailed description of the IO-Link functions, see [Functions \[▶ 24\]](#). For a detailed description of the diagnostic data, see [Diagnostic data \[▶ 39\]](#).

3.7 Dimensional drawing

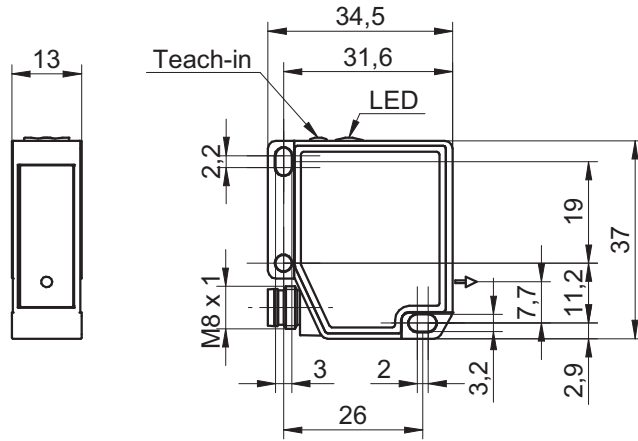

III. 4: Dimensional drawing OM20

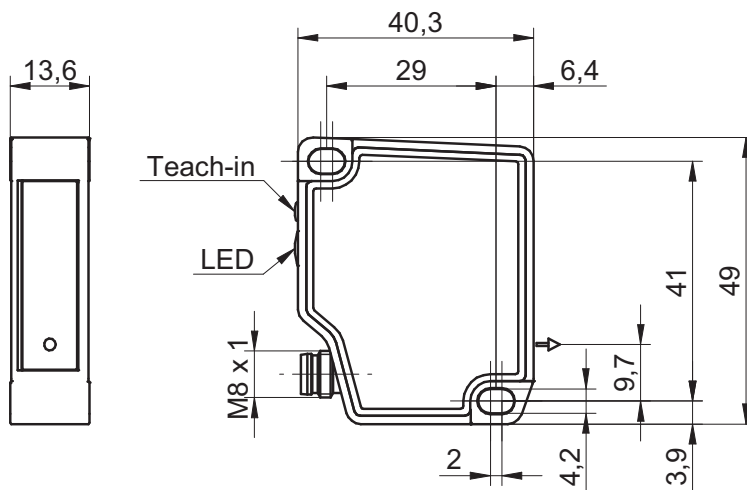

III. 5: Dimensional drawing OM30

4 Transport and storage

4.1 Transport

NOTICE

Material damage due to improper transport.

- a) Practice the greatest diligence when unloading the delivery packages and when transporting them within the company.
- b) Note the information and symbols on the packaging.
- c) Only remove packaging immediately before installation.

4.2 Delivery inspection

Upon receipt immediately inspect the delivery for completeness and transport damage.

Claim any defect as soon as it is detected. Damages can only be claimed within the applicable claims deadlines.

In case of externally visible transport damage, proceed as follows:

Instruction:

- a) Do not accept the delivery or only with reservations.
- b) Note the scope of the damage on the transport documents or the delivery slip of the carrier.
- c) Initiate the claim.

4.3 Storage

Store the product at the following conditions:

- Do not store outdoors.
- Store dry and free from dust.
- Do not expose to aggressive media.
- Keep away from the sun.
- Avoid mechanical agitation.
- Storage temperature: -10 ... +60 °C
- Ambient humidity: 20 ... 85 %
- When storing for longer than 3 months, regularly check the general state of all parts and the packaging.

5 Installation instructions



INFO

You can find the suitable installation accessories on the Baumer website. Go to www.baumer.com for this. Then enter the item number of the sensor in the search field of the website.

- For measurement objects with shiny surfaces: Tilt the sensor 6 to 10° to the side so that the light directly reflected by the surface does not hit the receiver of the sensor.
- For mounting, use at least 1 tooth lock washer to break open the paint layer of the sensor.

	OM20	OM30
Screws:	2 × M3	2 × M4
Torque:	0.6 Nm ±10 %	1 Nm ±10 %

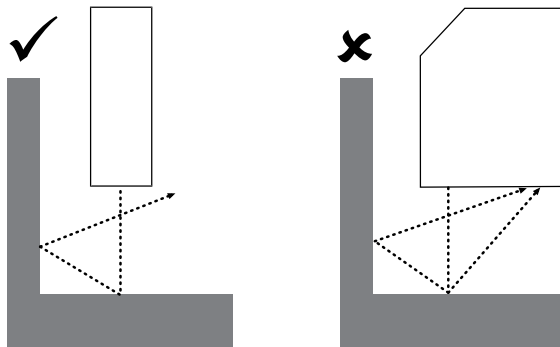

Mounting the sensor near a wall or a machine component:

Mount the sensor parallel to the wall to prevent disruptive reflections.

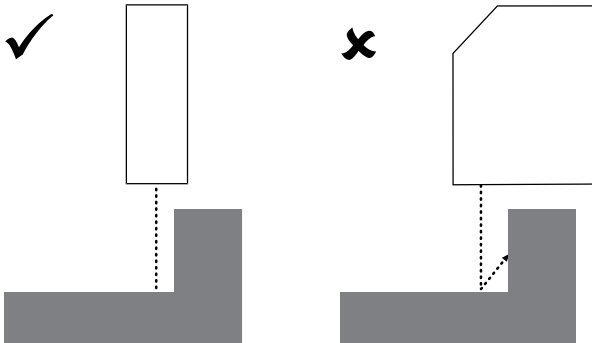

Measurement objects with height differences / measurements in holes or cracks:

Mount the sensor in such a way that the reception beam is not interrupted by the step.

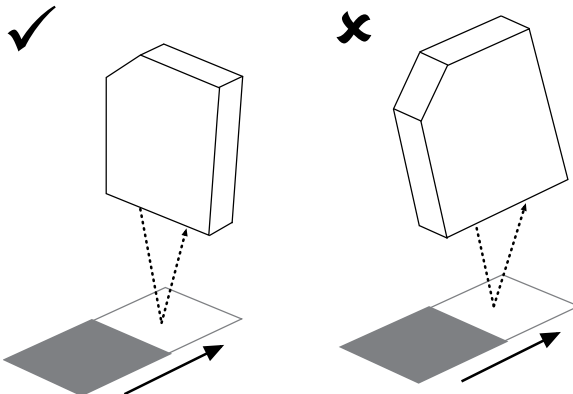

Mounting for measuring objects with colored edges / different reflective characteristics of the surface:

Align the sensor parallel to the colored edge to prevent measurement errors.

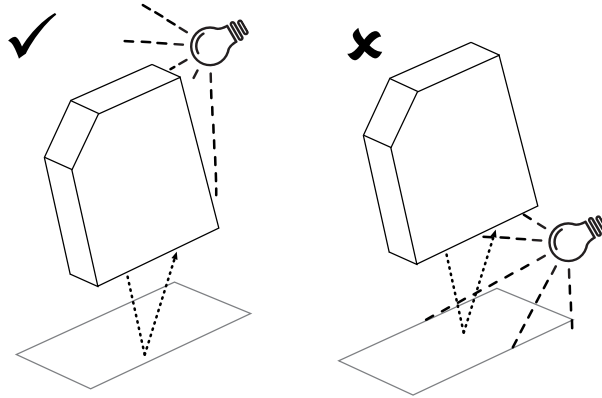

Mounting near strong ambient light:

Prevent the ambient light from entering the detection range of the receiver.

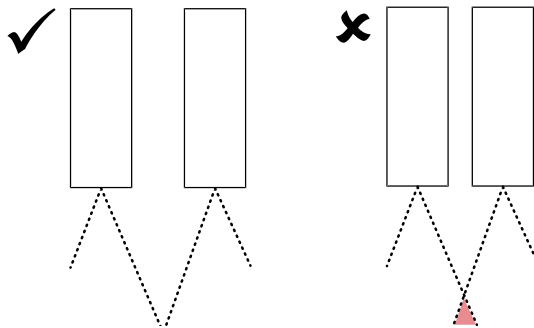

Mounting several sensors close to each other:

Prevent the detection ranges of the receivers from overlapping. Only the sensor's own laser spot may be in the detection range of the receiver.

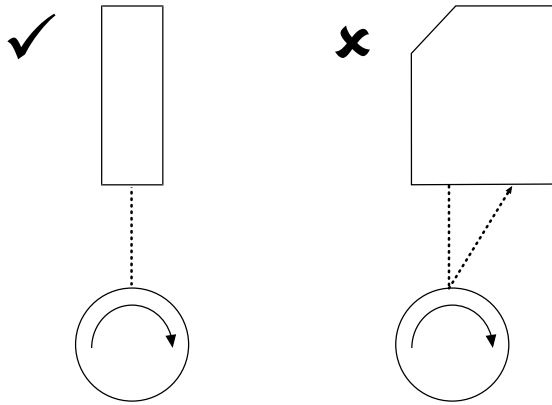

Mounting for round measurement objects:

Align the sensor on the same axis as the measurement object to prevent reflections.

6 Electrical installation

6.1 Pin assignment

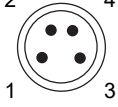
	1	+Vs
	2	analog
	3	0 V
	4	output / IO-Link

6.2 Connection diagram

	1	BN – Brown
	2	WH – White
	3	BU – Blue
	4	BK – Black

6.3 Connecting the sensor to electricity

Instruction:

- Ensure that the system is disconnected from power.
- Connect the sensor according to the pin assignment.

7 Commissioning

7.1 Factory settings

Adjustable parameters	Factory setting of the sensor	
Operation Mode	Precision Filter	Highest
	Sampling Mode	Free Running
Measurement Range	Zero Position	0 mm
	Distance Near	Sdc
	Distance Far	Sde
Invalid Value Handling	Value after Dropout	Near
	Hold Time	0 ms
SSC1 Configuration	SP 1	Sde -10 mm ^I
	SP 2	Sdc +10 mm ^{II}
	Polarity	Active High
	Mode	Window
	Hysteresis	<i>depending on MR</i>
Input/Output Settings	OUT1 Mode (Output & LED function)	SSC1 - Alarm
Analog Output	Output Type	4 ... 20 mA / 0 ... 10 VDC
	Output Characteristic	Not inverted
	Distance @AnalogMin	Sdc
	Distance @AnalogMax	Sde
	Local User Interface	Local Teach Mode
	Button Time Out	5 min
Device Access Locks	Data Storage Lock	False

^I Type OM20-P0026.xx.xxx: SSC1 Param.SP 1 = -2 mm

^{II} Type OM20-P0026.xx.xxx: SSC1 Param.SP 2 = +2 mm

7.2 Setting up IO-Link

Instruction:

- ◆ Download the IODD file for the sensor from one of the following two websites (the IODD file can be found via the item number of the sensor):

www.baumer.com

or

ioddfinder.io-link.com

8 Functions

8.1 Filter

With the *Filter* function, the noise can be reduced and the repeatability increased.

The number of measured values per string of numbers (filter length) can be adjusted as follows via the parameter settings:

- Option 1: Select the required filter length from predefined filter lengths.
 - Standard
 - High
 - Very High
 - Highest
- Option 2: Enter the required filter length as a numerical value.
 - Custom

General

The response and drop-off times are increased and moving objects can be detected with a delay as a result. The precision filter calculates the results in the form of floating values. The oldest measured value is removed as soon as a new measurement is added. Therefore the measuring frequency is not affected by the precision filter.

In the factory settings, the filter is set to *Highest*. In general, the more measured values per filter, the better the repeatability and the higher the reproducibility of the results.

Moving Median filter

This filter allows the suppression of individual measurement errors by calculating the median of a specified number of measured values in a string of numbers. The median value is the measured value located right “in the center” if the measured values are sorted by size.

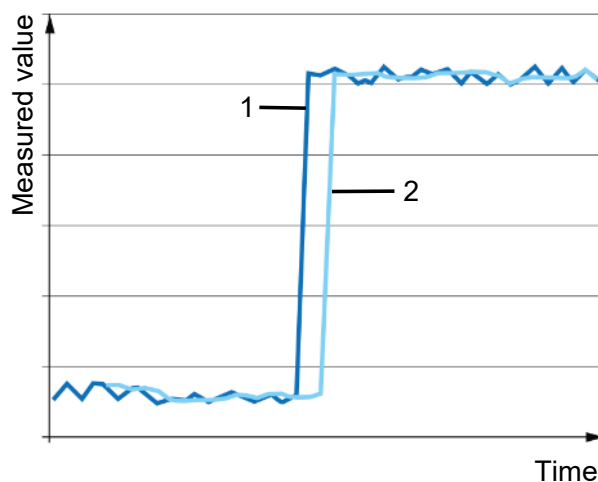

III. 6: *Moving Median filter*

1	Raw data	2	Data after filtering with Moving Median
---	----------	---	---

Moving Average filter

This filter smooths the signal course by calculating the average of a specified number of measured values in a string of numbers. Due to average calculation, a change in distance becomes increasingly visible.

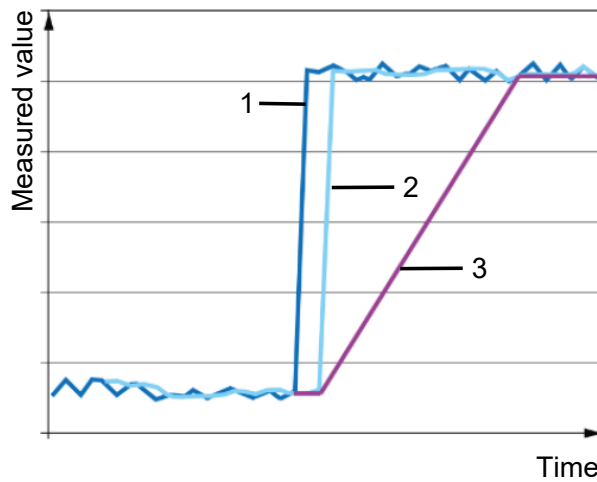

III. 7: Moving Average filter

1	Raw data	2	Data after filtering with Moving Median
3	Data after filtering with Moving Average and Moving Median		

The higher the number of measured values per filter, the longer the response time of the sensor. This means that a change in distance only becomes fully visible for the output after a delay.

Option 1: Select the required filter length from predefined filter lengths

The following selection options are available:

Value	Number of measured values	
	Moving Median	Moving Average
Standard	1	1
High	9	1
Very High	9	16
Highest	9	128



INFO

When several sensors are calculated, for example, for thickness measurement, the *Standard* filter should always be chosen to obtain a raw measured value of both sensors for further calculations.

Option 2: Enter the filter length as a numerical value

If the predefined filter lengths are not suitable, an individual filter length can be entered for the *Moving Average* and *Moving Median* filters. Especially when it comes to applications without dynamic changes in distances, such as the verification of the position of an object, a greater filter length can improve the performance of the sensor. You can specify the length of the *Moving Average* and *Moving Median* filters after selecting the *Custom* filter.

- *Moving Median* filter: 1 - 21 values
- *Moving Average* filter: 1 - 256 values

IO-Link parameter: *Filter* operating mode

Parameter name	Values	Description
Operation Mode.Precision Filter	Standard, High, Very High, Highest, Custom	<ul style="list-style-type: none"> ▪ Selection among predefined filters (number of measured values per filter). ▪ Custom: Enter the filter length as a numerical value.
MovAvgFilter.Custom Moving Average Length	-	<ul style="list-style-type: none"> ▪ Freely configurable filter length for <i>Moving Average</i>.
MovMedianFilter.Custom Moving Median Length	-	<ul style="list-style-type: none"> ▪ Freely configurable filter length for <i>Moving Median</i>.

8.2 Trigger mode

The *Trigger mode* function controls the acquisition of the measured values and thus also the measurement frequency. The parameter settings offer you a choice between the *Free Running* and *Interval* trigger modes.

Free Running trigger mode

- The sensor measures constantly and at the highest possible measurement frequency.
- The maximum measurement frequency varies depending on the characteristics of the measurement object (or the exposure time). Example: Dark measurement objects (longer exposure time) result in a lower measurement frequency than light-colored measurement objects.
- The maximum measurement frequency is independent of the selected filter settings, since measurement and processing of data proceed simultaneously.
- Purpose/application: The *Free Running* trigger mode can be used in most applications (factory setting). The fastest possible recording of measurement results ensures a larger amount of data.

Interval trigger mode

- The sensor measures with a constant time interval (adjustable in μs).
- Observe the maximum possible measurement frequency in the *Interval* mode as well. If the maximum possible measurement frequency is exceeded, the performance can worsen. Therefore:
 - Measure the maximum possible measurement frequency in the *Free Running* mode.
 - Calculate the minimum time interval as follows:
min. time interval = $1/\text{max. measurement frequency}$
- Purpose/application: Use with dynamic applications (e.g. measurement objects on a conveyor belt) to detect all measurement objects.

IO-Link parameter: *Sampling Mode (Trigger)* operating mode

Parameter name	Values	Description
OperationMode.Sampling Mode	Free Running, Interval	<ul style="list-style-type: none"> ▪ Trigger mode
OperationMode.Sampling Time	-	<ul style="list-style-type: none"> ▪ Time interval for the <i>Interval</i> trigger mode

8.3 Zero position

The measured distance value is relative to the set zero point position. By default, the zero position of the sensor coincides with the sensor front and can be set to any value between 0 and the maximum measurement distance of the sensor. The distance value and the switching point positions are calculated relative to the zero position. The function allows tolerance measurements for quality testing, for example.

Example 1:

- Physical distance to the object to be measured: 150 mm
- Set zero position: 0 mm (default setting)
- Output measured value: 150 mm.

Example 2:

- Physical distance to the object to be measured: 150 mm
- Set zero position: 100 mm
- Output measured value: 50 mm.



INFO

Negative values are not permitted for the zero position.

IO-Link parameter: Zero position

Parameter name	Values	Description
Zero Position.Zero Position	-	▪ Zero position
Baumer commands – Zero Position Teach	-	▪ Teach in the current position as the new zero position.

8.4 Measurement range

With the *Measurement range* function, the limits of the measurement range can be set so that the active measurement range is limited to a partial range of the maximum measurement range of the sensor. The purpose of this function is to eliminate interfering reflections (e.g. if there is a pane of glass between the sensor and the object to be measured).

- The Near limit of the measurement range must be larger than the minimum limitation of the sensor (Sdc).
- The Far limit of the measurement range must be smaller than the maximum limitation of the sensor (Sde).

The alarm output is activated as soon as no object to be measured is located within the configured measurement range or the signal quality is insufficient.

IO-Link parameter: Measurement range

Parameter name	Values	Description
Measurement Range. Distance Near	-	▪ Near limit of the measurement range
Measurement Range. Distance Far	-	▪ Far limit of the measurement range

8.5 Invalid Value Handling

The *Invalid Value Handling* function defines the behavior of the sensor when the sensor records an invalid measured value. This function can be used, for example, to mask recurring reflections of machine parts or reflections of measurement objects in a dynamic application. Invalid measured values occur when

- there are no objects in the measurement range (MR) or
- the signal is too weak due to reflections or unidentifiable objects.

The function can be configured via the following parameters:

- Specify the status of the analog output in case of invalid measured values. Possible options:
 - The analog output holds the last valid measured value.
 - The analog output holds the min. output point.
 - The analog output holds the max. output point.
- Time period (Hold Time) during which an invalid measured value should be suppressed. The time period is used to mask invalid measured values at the outputs. The output (digital or analog output) is set only after expiration of the time period.

Invalid Value Handling – example 1

- Parameters:
 - Type of Invalid Value Handling: *min. output point*
 - Time period (Hold Time): *1000 ms*
- Interpretation: Invalid measured values are ignored at both the digital and analog output. The last valid value is maintained during the time period. The type of Invalid Value Handling has no effect yet at this point.

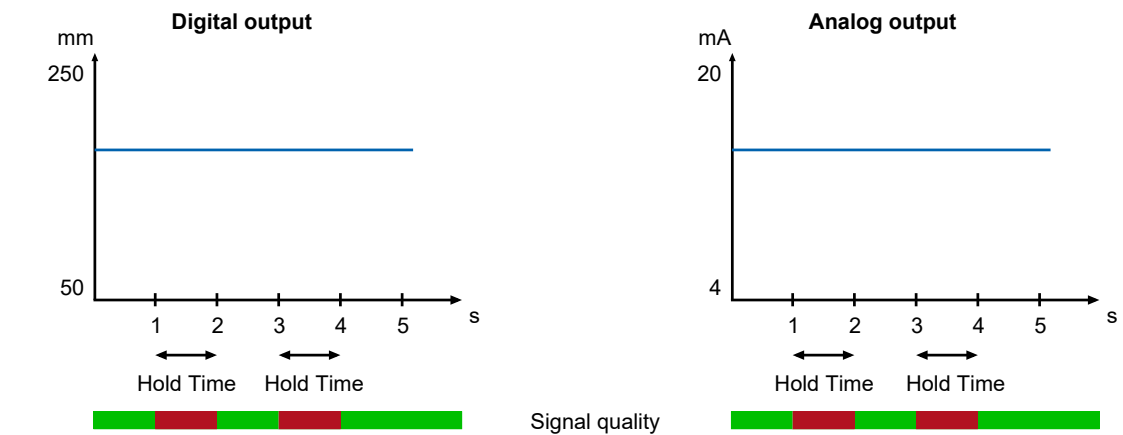

III. 8: Invalid Value Handling – example 1

Invalid Value Handling – example 2

- Parameters:
 - Type of Invalid Value Handling: *min. output point*
 - Time period (Hold Time): *1000 ms*
- Interpretation: After expiration of the time period, the placeholder for an invalid value is output at the digital output. For the analog output, the type of Invalid Value Handling applies and the electrical power drops to 4 mA.

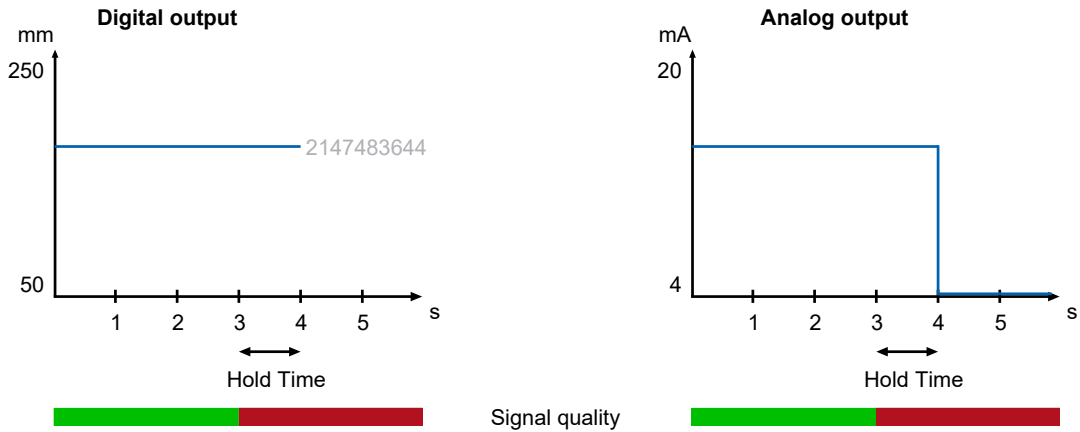

III. 9: Invalid Value Handling – example 2

IO-Link parameter: Invalid Value Handling

Parameter name	Values	Description
AnalogSetting.Value after Dropout	Last valid, near, far	<ul style="list-style-type: none"> ■ Type of Invalid Value Handling: <ul style="list-style-type: none"> ▪ Last valid: Last valid measured value ▪ near: min. output point ▪ far: max. output point
Process Value Disruption Filter.Hold Time	-	<ul style="list-style-type: none"> ■ Time period during which an invalid measured value is suppressed.

8.6 Switching points

Via the *Switching Points* function, distances (switching points) are defined at which the switching output is to be activated.

The function can be configured via the following parameters:

- Select measurement mode (point mode or window mode).
- Define the position of the switching points (SP1 and SP2):
 - Point mode: SP1
 - Window mode: SP1 and SP2

Point mode

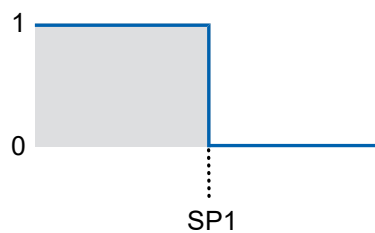

III. 10: Sensor in the point mode measurement mode

- Purpose/application (example):
 - Quality control: Check the minimum/maximum height of a measurement object.
 - Reach a desired position with a tool that edits an object.

Window mode

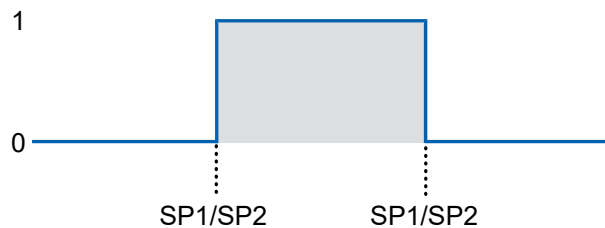

III. 11: Sensor in the window mode measurement mode

- Purpose/application (example):
 - Quality control: Check the dimensions of a measurement object within a tolerance window.

IO-Link parameter: Switching points

Parameter name	Values	Description
SSC1 Config.Mode	Disabled, Single Point, Window	<ul style="list-style-type: none"> ▪ Selecting the switching output mode: <ul style="list-style-type: none"> ▪ Point mode: (switching point SP1) ▪ Window mode (SP1 and SP2)
SSC1 Param.SP1	-	<ul style="list-style-type: none"> ▪ Distance at which the SSC1 is activated or inactivated.
SSC1 Param.SP2	-	<ul style="list-style-type: none"> ▪ Distance at which the SSC1 is activated or inactivated. Only relevant for window mode.

8.7 Polarity

With the *Polarity* function, you can define the behavior of the switching outputs regarding the output level.

With parameterization you can choose between *Active High* and *Active Low*.

Active High

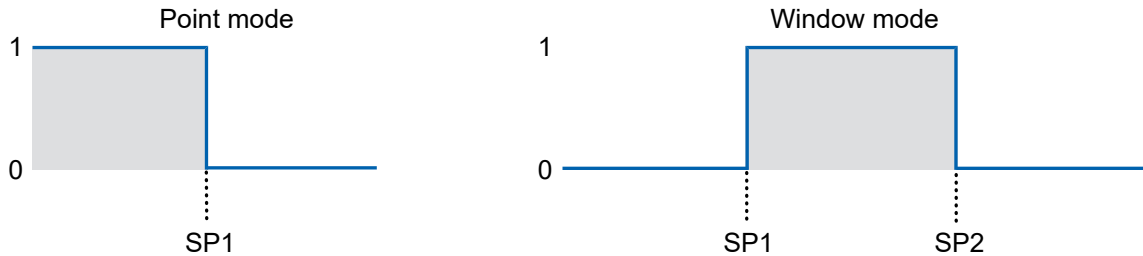

III. 12: Polarity – Active High

- Point mode: The switching output is activated as soon as the defined distance SP1 is not reached.
- Window mode: The switching output is activated as soon as the measured value is within the window of SP1 and SP2.

Active Low

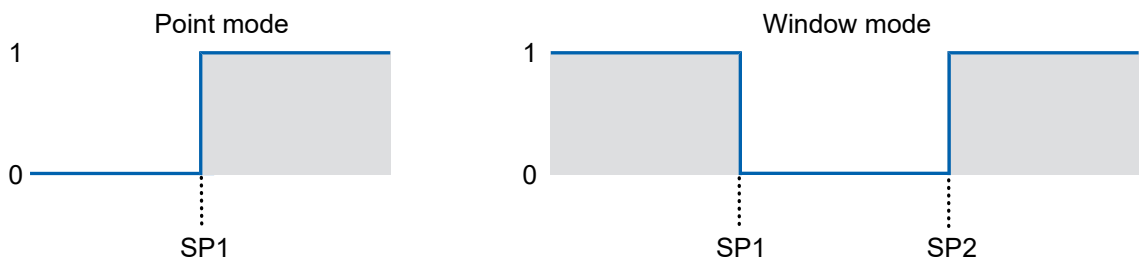

III. 13: Polarity – Active Low

- Point mode: The switching output is activated as soon as the defined distance SP1 is exceeded.
- Window mode: The switching output is activated as soon as the measured value is outside the window of SP1 and SP2.

IO-Link parameter: Polarity

Parameter name	Values	Description
SSC1 Config.Polarity	Active Low, Active High	Polarity of the switching output

8.8 Hysteresis

The *Hysteresis* prevents unwanted switching of the switching output. The parameterized value of the hysteresis is the difference in distance between the points at which the switching output is activated and deactivated. Baumer recommends always setting the hysteresis not equal to 0.

Positive hysteresis

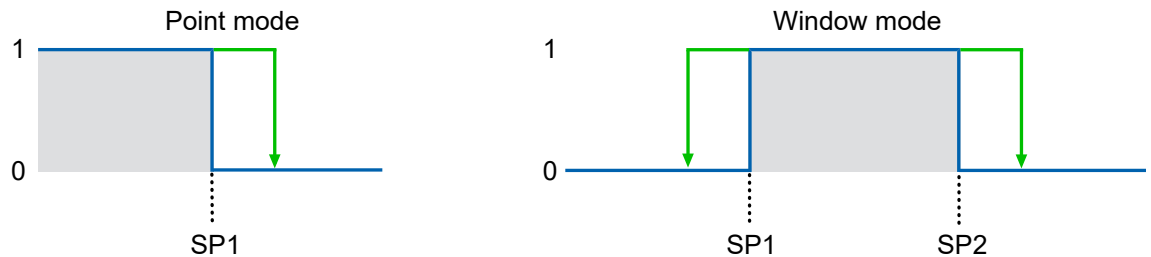

III. 14: Positive hysteresis

- Switching output in point mode: A positive hysteresis value corresponds to a right aligned hysteresis.
- Switching output in window mode: A positive hysteresis value corresponds to a hysteresis aligned outside of the window.
- Example:
 - Measuring mode of the switching output: point mode
 - Switching point (SP1): 200 mm
 - Hysteresis: 1.5 mm
 - This results in a right aligned hysteresis. If the measured distance is less than 200 mm, the switching output is active. If the object to be measured moves from 200 mm to 201 mm, the switching output remains active due to the hysteresis. As soon as the measured distance is greater than 201.5 mm, the switching output is deactivated (switching output switches to *low*). If the object to be measured moves from 202 mm to 201 mm, the switching output remains deactivated. The switching output only changes its state at 200 mm (parameterized switching point).

Negative hysteresis

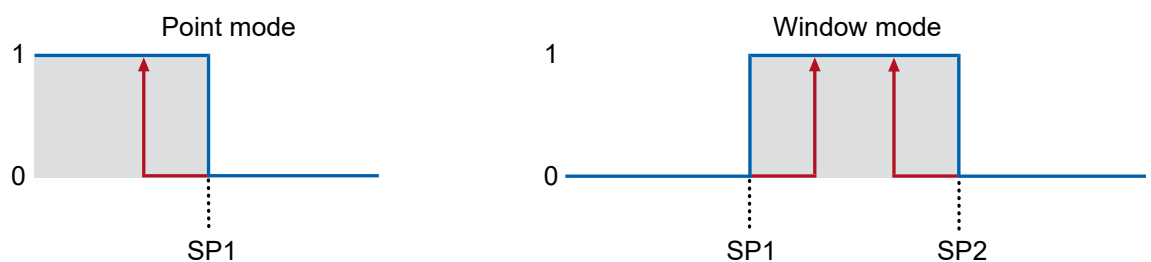

III. 15: Negative hysteresis

- Switching output in point mode: A negative hysteresis value corresponds to a left aligned hysteresis.
- Switching output in window mode: A negative hysteresis value corresponds to a hysteresis aligned within the window.
- Example:
 - Measuring mode of the switching output: window mode
 - Switching point 1 (SP1): 200 mm
 - Switching point 2 (SP2): 300 mm
 - Hysteresis: -1.5 mm

- This results in a left aligned hysteresis. When the object to be measured nears the switching points from outside of the window, the switching output remains deactivated until a distance of 201.5 mm and 298.5 mm. When the object to be measured nears the switching points from the inside of the window, the switching output remains active until 200 mm and 300 mm (parameterized switching points).

Point mode (switching output behavior)

Positive hysteresis:

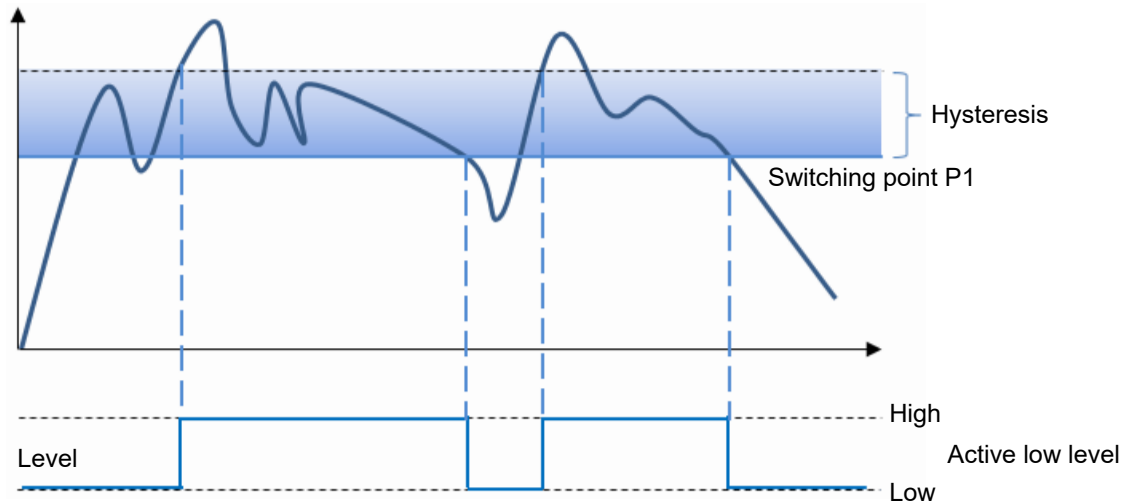

III. 16: Behavior of the switching output in point mode (positive hysteresis)

Negative hysteresis:

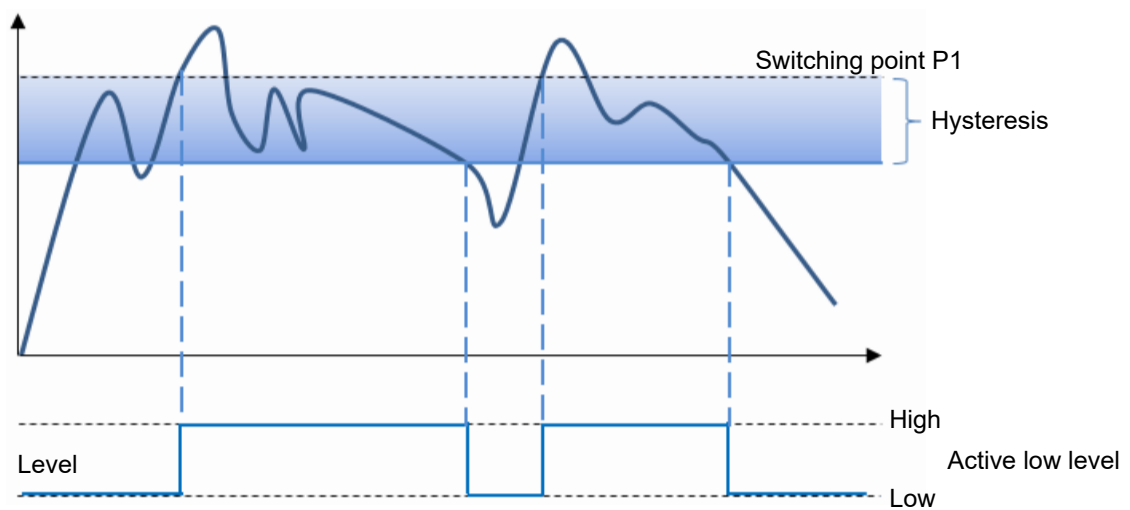

III. 17: Behavior of the switching output in point mode (negative hysteresis)

Window mode (switching output behavior)

Positive hysteresis:

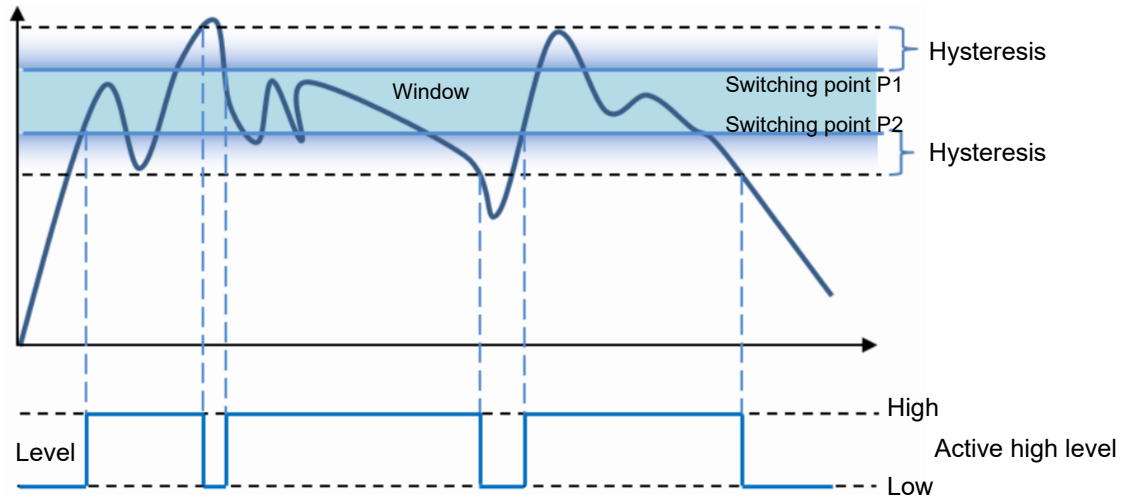

III. 18: Behavior of the switching output in window mode (positive hysteresis)

Negative hysteresis:

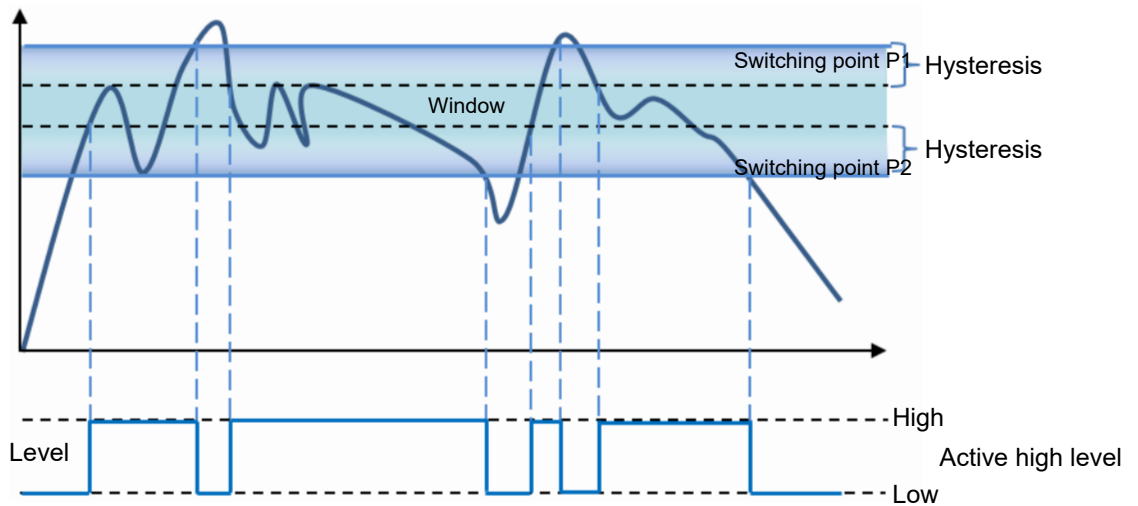

III. 19: Behavior of the switching output in window mode (negative hysteresis)

IO-Link parameter: Hysteresis

Parameter name	Values	Description
Hysteresis.SSC1 Width	-	Enter the hysteresis as a positive or negative numerical value (in mm).

8.9 Function of the output

The IO-Link communication principle can also be used as a switching output. In the factory settings, the function of the output is equivalent to the alarm output. This means that the output is activated as soon as no measured value can be recorded. Through IO-Link this can be switched to a switching output than can be parameterized.

IO-Link parameter: Output

Parameter name	Values	Description
DI/DO Settings.OUT 1 Mode	SSC1 - Alarm, SSC1 - Switch State	Select the function of the output.

8.10 Analog measurement field

With the *Analog measurement field* function, you can define the resolution of the analog output by moving the limits of the analog measurement field. When the analog measurement field is limited, smaller distance changes can be displayed.

The function can be configured via the following parameters:

- Min. limit of the analog measurement range (factory setting: Sdc)
- Max. limit of the analog measurement range (factory setting: Sde)

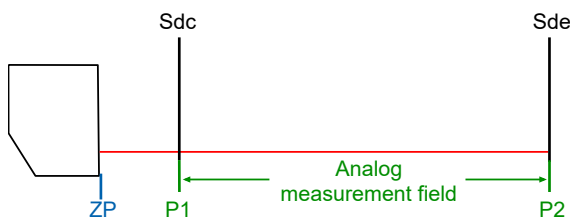

III. 20: Analog measurement field (factory setting)

Sdc	Start of the measurement range	Sde	End of the measurement range
P1	Min. limit of the analog measurement range	P2	Max. limit of the analog measurement range
ZP	Zero position		

You have the option of inverting the characteristic curve of the analog measurement field.

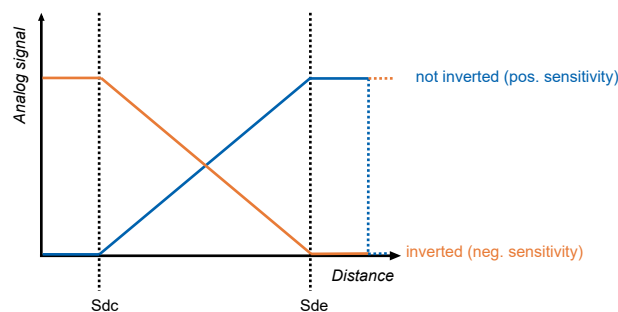

III. 21: Analog measurement field – inverted

Examples of the behavior of the analog output

Behavior with invalid measured values: **near**

Characteristic curve inverted: **no**

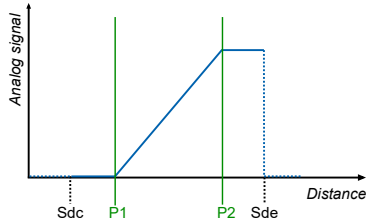

Behavior with invalid measured values: **far**

Characteristic curve inverted: **no**

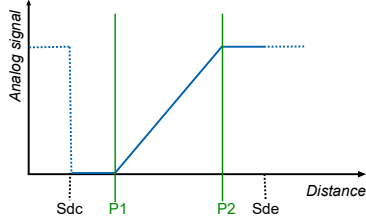

Behavior with invalid measured values: **near**

Characteristic curve inverted: **yes**

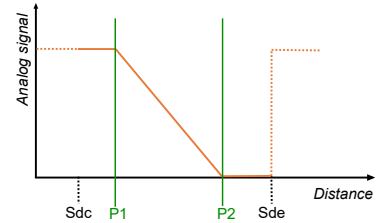

Behavior with invalid measured values: **far**

Characteristic curve inverted: **yes**

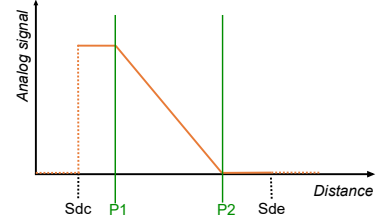

IO-Link parameter: Analog measurement field

Parameter name	Values	Description
AnalogSetting.Output Type	4 ... 20 mA, 2 ... 10 mA/ 0 ... 10 VDC, 0 ... 5 VDC	Configuring the range of the analog output
Distance@Analog Min	-	Enter the min. limit of the analog measurement range (in mm)
Distance@Analog Max	-	Enter the max. limit of the analog measurement range (in mm)
Output Characteristic	Not Inverted, Inverted	Inverting the analog output
Baumer commands – Output Scale at Analog Min	-	Teach in min. limit of the analog measurement range (alternatively to the Teach button)
Baumer commands – Output Scale at Analog Max	-	Teach in max. limit of the analog measurement range (alternatively to the Teach button)
Baumer commands – Output Scale is set to the possible max.	-	Set the analog measurement range to the max. possible limits

8.11 Function of the Teach button

With the Teach button function (*Local User Interface*), you have the option of specifying the mode of the Teach button. You have a choice between the *Xpert* (factory setting) and *Xpress* modes. The mode is selected via the IO-Link.

Adjustable parameters in the *Xpert* mode:

- Analog measurement field
- Zero position
- Resetting the sensor to the factory settings

For more information on the operation of the Teach button in the *Xpert* mode, see [Teach button \[11\]](#).

Adjustable parameters in the *Xpress* mode:

- Zero position

The Teach button is automatically deactivated after 5 min (the timeout can be parameterized via IO-Link).

Teaching the zero position (in the *Xpress* mode)

Instruction:

- a) Place the measurement object at the desired position for the zero position.
- b) Keep the Teach button pressed for 2 seconds.
 - ✓ Green LED blinks with 2 Hz.

Result:

- ✓ Teach-In ok: Sensor goes back to the operating mode.
- ✓ Teach-in not OK: Green and yellow LEDs blink simultaneously with 8 Hz.

IO-Link parameter: Teach button (Local User Interface)

Parameter name	Values	Description
Teach Mode Settings.Local Teach Mode	<i>Xpert</i> , <i>Xpress</i>	Selecting the mode for the Teach button
Teach Lock Settings.Button Time Out -		Enter the time period (Timeout) after which the Teach button should be deactivated after a teach-in process (in min). With a value of 0, the Teach button is always activated. With a value of 255 (0xFF), the Teach button is permanently deactivated.

9 Diagnostic data

The diagnostic data is used for monitoring the status of the device. You can monitor both the momentary status (via parameters) as well as the development over time (via a histogram function). You have the option of resetting diagnostic data.

9.1 Measurement rate

The measurement rate is equivalent to the number of measurements per second. Example: With a measurement rate of 500 Hz, a measurement takes place every 0.002 s ($1/500 \text{ Hz} = 0.002 \text{ s}$). The measurement rate is useful for the following questions, among others:

- How quickly can a change in distance be detected?
- How many measurements can be performed on a static object?



INFO

The max. speed in dynamic applications is limited by the measurement rate, and the distance change at the output is influenced by the selected filter value settings. Therefore, consider the measurement rate in connection with the settings of the filter.

The measuring frequency value depends on the exposure time. The sensor automatically adjusts its exposure time to the object to be measured in order to always receive an optimum light quantity and thus achieve a sufficient exposure reserve. The exposure time depends on the properties of the measured surface (color/structure, etc.) and the alignment of the sensor to the object to be measured. Dark objects to be measured reflect less light and thus need longer exposure times than light-colored objects, decreasing the measuring frequency. The measurement and change of the output always take place with the same frequency.

IO-Link diagnostic data: Measurement rate

Name	Description
Measurement Values. PV1 Rate	Output of the measuring rate.

9.2 Response delay

The response delay is equivalent to the time elapsed between the triggering of the measurement (internal signal) and the change in the measured value at the output.

The duration of the response delay depends on the exposure time. The sensor automatically adjusts its exposure time to the object to be measured in order to always receive an optimum light quantity and thus achieve a sufficient exposure reserve. The exposure time depends on the properties of the measured surface (color/structure, etc.) and the alignment of the sensor to the object to be measured. Dark objects to be measured reflect less light and thus need longer exposure times than light-colored objects; the response delay increases.

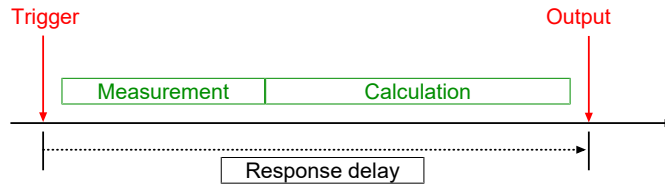

III. 22: Response delay



INFO

Filter settings do not affect the response delay.

IO-Link diagnostic data: Response delay

Name	Description
Measurement Values. PV1 Response Delay	Output of the response delay.

9.3 Exposure reserve

The exposure reserve indicates the light quantity reflected by the measurement object (as a relative factor without unit). The exposure reserve helps you with the following problems, among others:

- Check whether a valid measurement result is present (signal quality). The signal quality is weak
 - when the sensor is not optimally aligned, and
 - when the distance between the sensor and measurement object is too large.
- During ongoing operation: Check the front panel of the sensor for contamination – if the exposure reserve decreases over time, it may be an indication of increased contamination of the front panel. Use the histogram function for this purpose ([Histogram function \[▶ 42\]](#)).

IO-Link diagnostic data: Exposure reserve

Name	Description
Exposure Reserve. Exposure Reserve	Output of the exposure reserve.

9.4 Signal quality

The signal quality serves as an indication of the reliability of the measurement.

IO-Link diagnostic data: Signal quality

Name	Description
Exposure Reserve.Quality Level	<ul style="list-style-type: none"> ▪ Output of the signal quality. <ul style="list-style-type: none"> ▪ 0 = Valid signal ▪ 1 = Weak signal <i>Low signal quality can result in greater measured value errors. Decrease the distance to the measurement object or optimize the alignment of the sensor.</i> ▪ 2 = Critical signal <i>Valid measured value acquisition is no longer guaranteed. Decrease the distance to the measurement object or optimize the alignment of the sensor. LEDs blink if a critical signal is reached. The alarm output is activated when no measured value can be recorded anymore.</i>

9.5 Device status

The device status provides information about the status of the device.

IO-Link diagnostic data: Device status

Name	Description
DeviceStatus	<ul style="list-style-type: none"> ▪ Output of the device status. <ul style="list-style-type: none"> ▪ 0 = Device OK (in the operating state) ▪ 1 = Maintenance required (critical signal quality) ▪ 2 = Outside the specification (measured value cannot be recorded)

9.6 Operating time

The operating time of the sensor is permanently recorded. 3 different time periods are available:

- Operating time since the last power up
- Operating time since an individually configurable point in time (by reset)
- Operating time since the initial power up

IO-Link diagnostic data: Operating time

Name	Description
Operation Time.Powerup	Output of the operating time since the last power up.
Operation Time.Resettable	Output of the operating time since an individually configurable point in time (by reset).
Operation Time.Lifetime	Operating time since the initial power up.

9.7 Histogram function

The histogram function counts the appearance of values within defined intervals (bins). The number of values refers to the followings key data:

- Distance
- Exposure reserve

Distance

With each cycle, a measured value (distance) is recorded. The following information is available:

- Unit
- Start of valid range
- End of valid range
- Number of intervals/bins

Example:

Measurement range of the sensor: 50 - 550 mm:

- Unit: mm
- Start of valid range: 50 mm
- End of valid range: 550 mm
- Number of intervals/bins: 20

This yields:

Interval/bin covers the following range: $(550 \text{ mm} - 50 \text{ mm})/20 = 25 \text{ mm}$

If the sensor records the value 76 mm 5 times and the value 162 mm 15 times in 20 measurements, the following distribution results:

Bin	Value range min.	Value range max.	Number of measurements
Bin 1	50 mm	< 75 mm	0
Bin 2	75 mm	< 100 mm	5
Bin 3	100 mm	< 125 mm	0
Bin 4	125 mm	< 150 mm	0
Bin 5	150 mm	< 175 mm	15
...

Example of a recorded distance histogram:

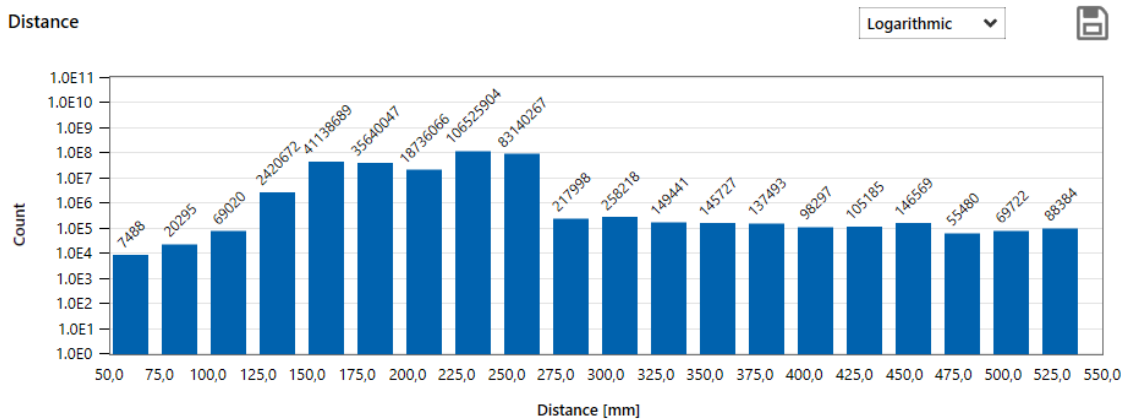

IO-Link diagnostic data: Distance histogram function

Name	Description
Baumer commands – Distance Resetable Histogram Reset	Resetting the distance histogram
Distance Resetable Histogram.Unit	Unit
Distance Resetable Histogram.Range Start	Start of valid range
Distance Resetable Histogram.Range End	End of valid range
Distance Resetable Histogram.Nbr of Bins	Number of intervals/bins
Distance Resetable Histogram.Bin 1 - 20	Bin 1 - 20

NOTICE

Reset the histogram after the zero position has been moved (the measured distance depends on the zero position).

Exposure reserve

In each measurement, a value is recorded for the exposure reserve.

As the exposure reserve is always described by a fixed value range, the following information has a fixed value:

- Start of valid range: 0
- End of valid range: 100
- Number of intervals/bins: 20

This yields:

1 interval covers a value range of 5.

Example:

The object to be measured is outside the measurement range for 5 measurements. Therefore, the sensor records an exposure reserve of 0. This results in the following distribution:

Bin	Value range min.	Value range max.	Number of measurements
Bin 1	0	< 5	5
Bin 2	5	< 10	0
Bin 3	10	< 15	0
Bin 4	15	< 20	0
Bin 5	20	< 25	0
...

Example of a recorded exposure reserve histogram:

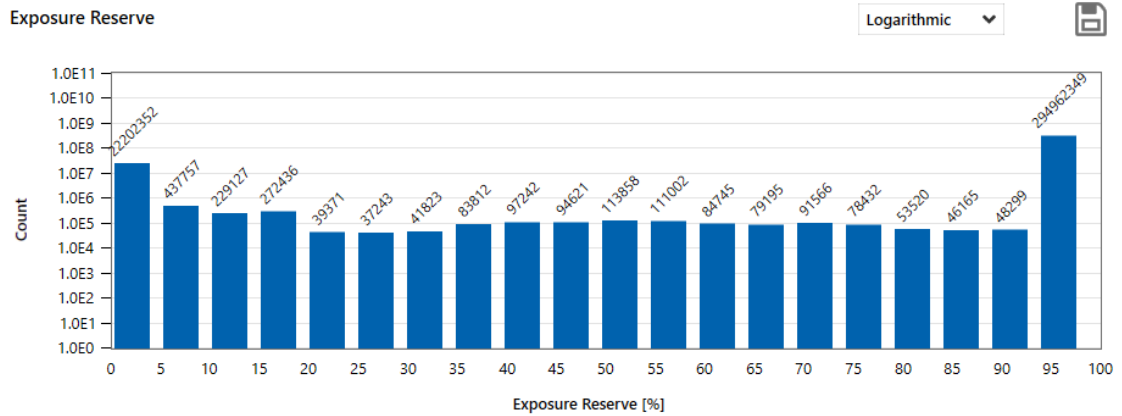

IO-Link diagnostic data: Exposure reserve histogram function

Name	Description
Baumer commands – Exposure Reserve Resetable Histogram Reset	Resetting the exposure reserve histogram
Exposure Reserve Resetable Histogram.Range Start	Start of valid range
Exposure Reserve Resetable Histogram.Range End	End of valid range
Exposure Reserve Resetable Histogram.Nbr of Bins	Number of intervals/bins
Exposure Reserve Resetable Histogram.Bin 1 - 20	Bin 1 - 20

10 Preventive maintenance

The sensor is maintenance-free. No special preventive maintenance is required. Regular cleaning and regular checking of the plug connections are recommended.

10.1 Cleaning the sensor

Exterior cleaning

When cleaning the exterior of the sensor, make sure to use cleaning agents that do not affect the housing surface and seals.

NOTICE

Material damage due to improper cleaning.

Unsuitable cleaning agents and methods can cause leaks and damage the sensor, the seals, or the connections.

- a) Always check the suitability of the cleaning agent for the surface to be cleaned.
 - b) Do not use scouring agents, solvents, or other aggressive cleaning agents.
 - c) Do not use jets of liquid for cleaning, for example, a high-pressure cleaner.
 - d) Do not scrape off contamination with sharp-edged items.
-

Interior cleaning

No interior cleaning of the sensor is required.

11 Troubleshooting

- **Error:**
Sensor does not start even though the power supply is connected. The LEDs of the sensor are switched off.
- **Possible cause:**
The power supply is interrupted. A short-circuit is present.
- **Remedy:**
Check the electrical connection of the sensor according to the connection diagram.
- **Error:**
No valid measured value can be recorded, the LED lights up yellow, and the laser is switched on.
- **Possible cause:**
The measurement object is outside of the measurement range (MR). The measurement range for your sensor version can be found in the data sheet.
- **Remedy:**
Move the measurement object into the measurement range.
- **Error:**
The measurement results are incorrect.
- **Possible cause:**
The direct reflection of the laser hits the receiver of the sensor. This happens especially with shiny surfaces.
- **Remedy:**
Tilt the sensor to the side so that the direct reflection of the laser does not hit the receiver of the sensor.
- **Error:**
The measured value shows faulty, erratic behavior.
- **Possible cause:**
Too much ambient light enters the field of view of the sensor receiver. This leads to disturbing peaks on the receiver.
- **Remedy:**
Reduce the ambient light (e. g. with a cover).

11.1 Return and repair

In case of complaints, please contact the relevant sales company.

11.2 Accessories

You can find accessories at the website at:

<https://www.baumer.com>

12 Annex

12.1 Analog output resolution - diagrams

The following diagrams show the resolution of the analog output in relation to the measuring distance for the different sensor types. The type code of the sensor shown is indicated in the caption.

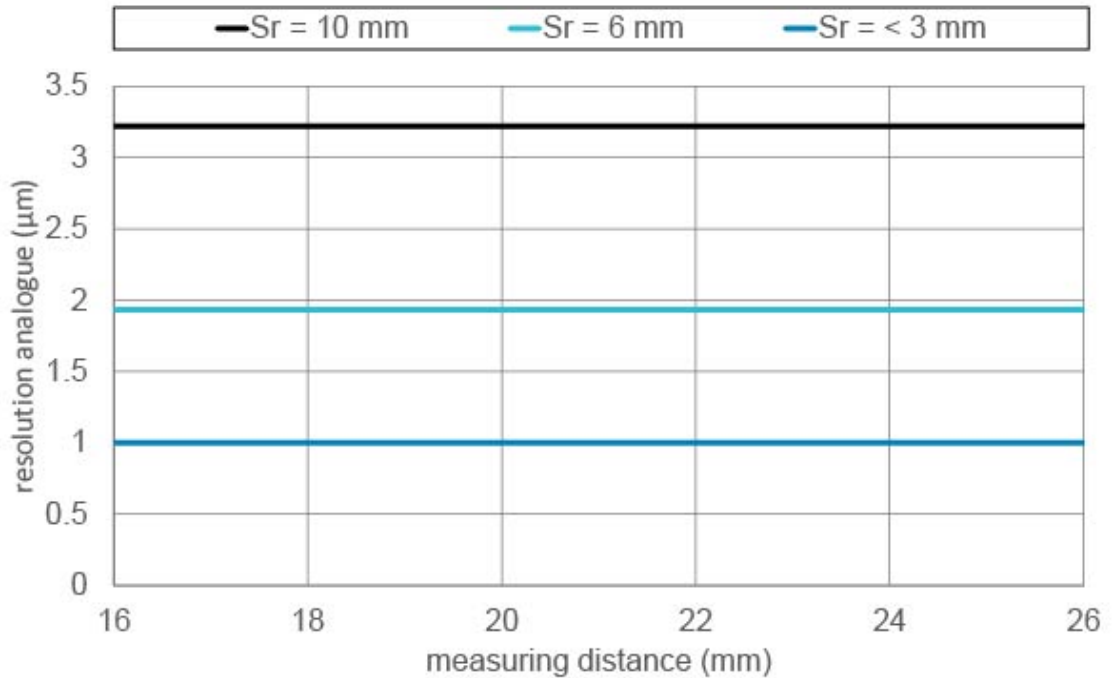

III. 23: Characteristic curves for OM20-x0026.xx.Yxx

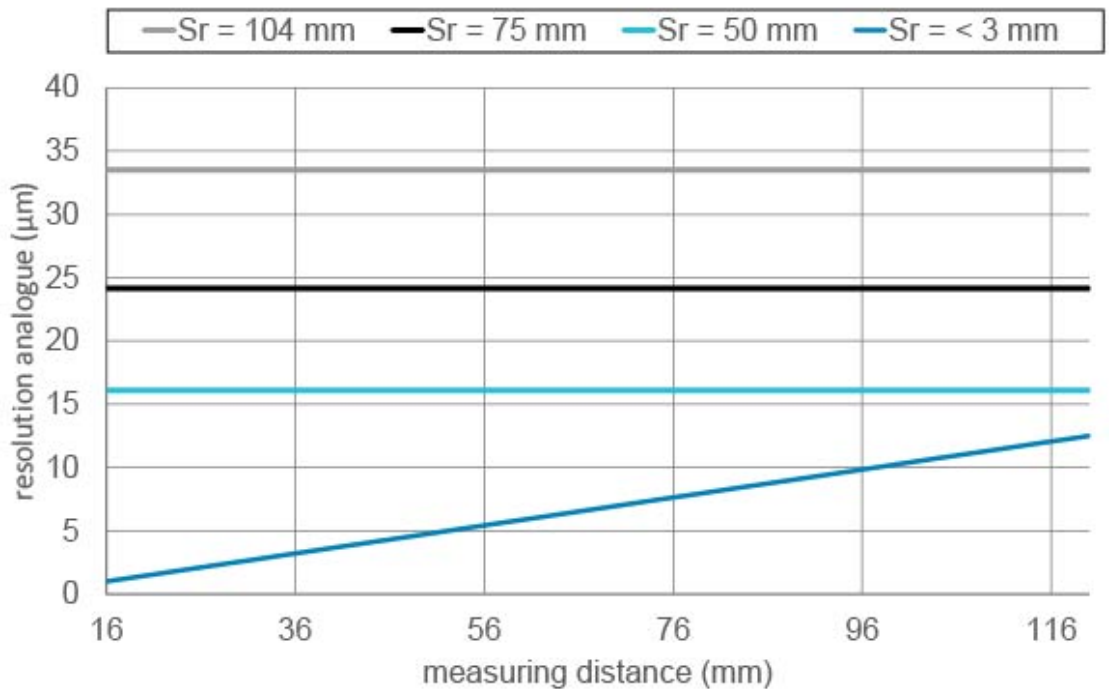

III. 24: Characteristic curves for OM20-x0120.xx.Yxx

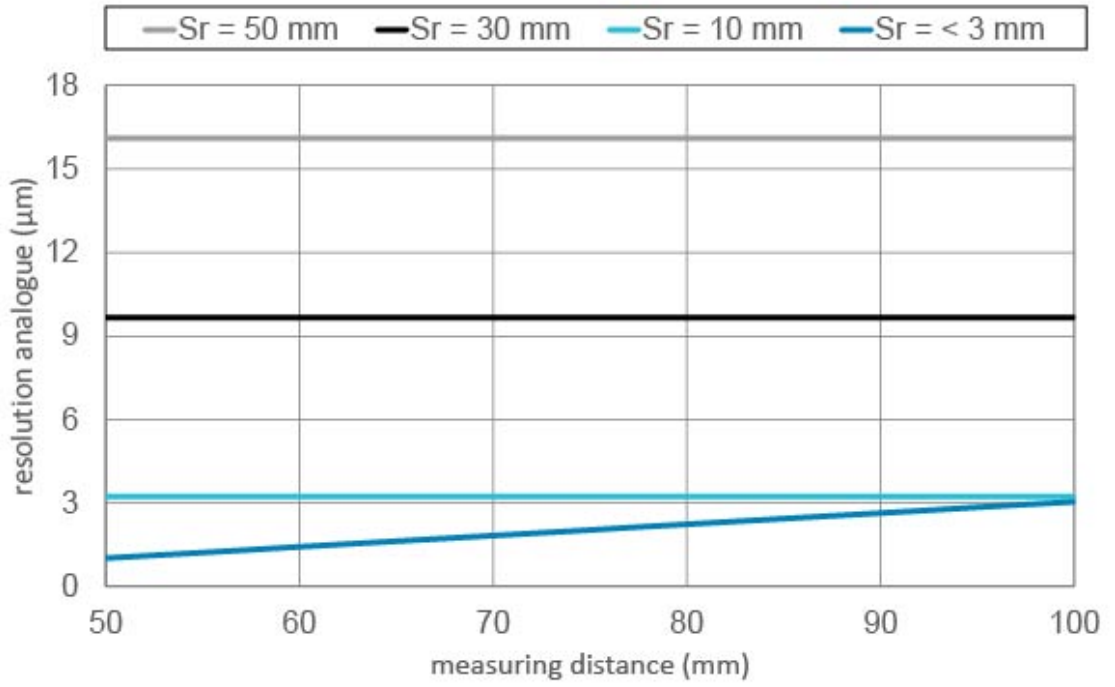

III. 25: Characteristic curves for OM30-x0100.xx.Yxx

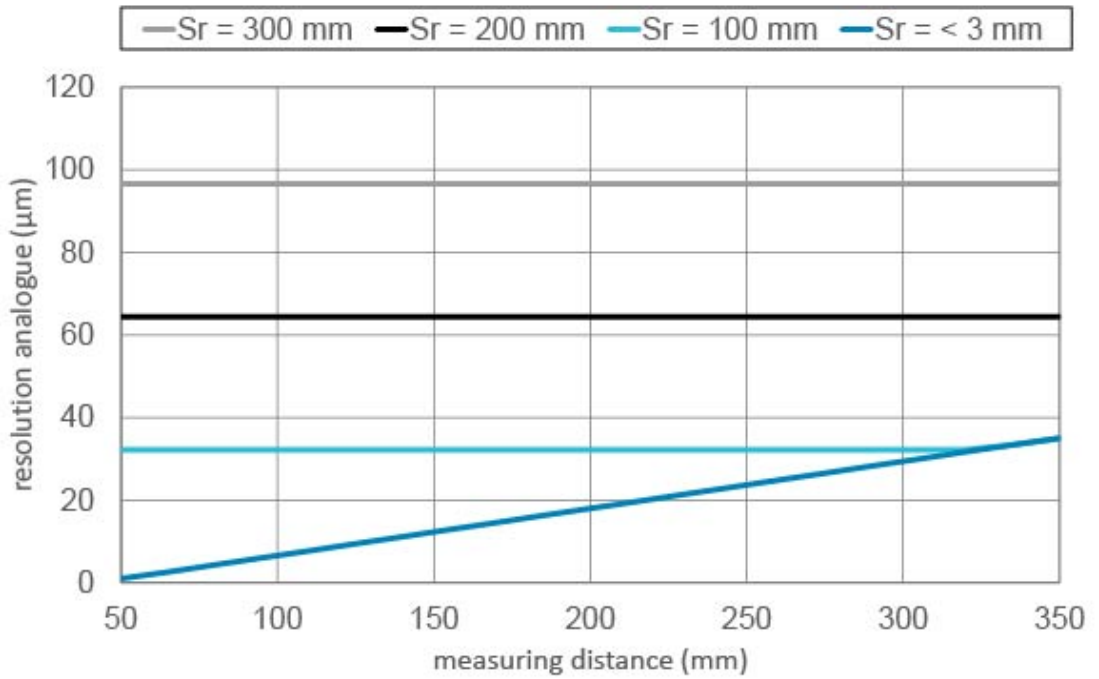

III. 26: Characteristic curves for OM30-x0350.xx.Yxx

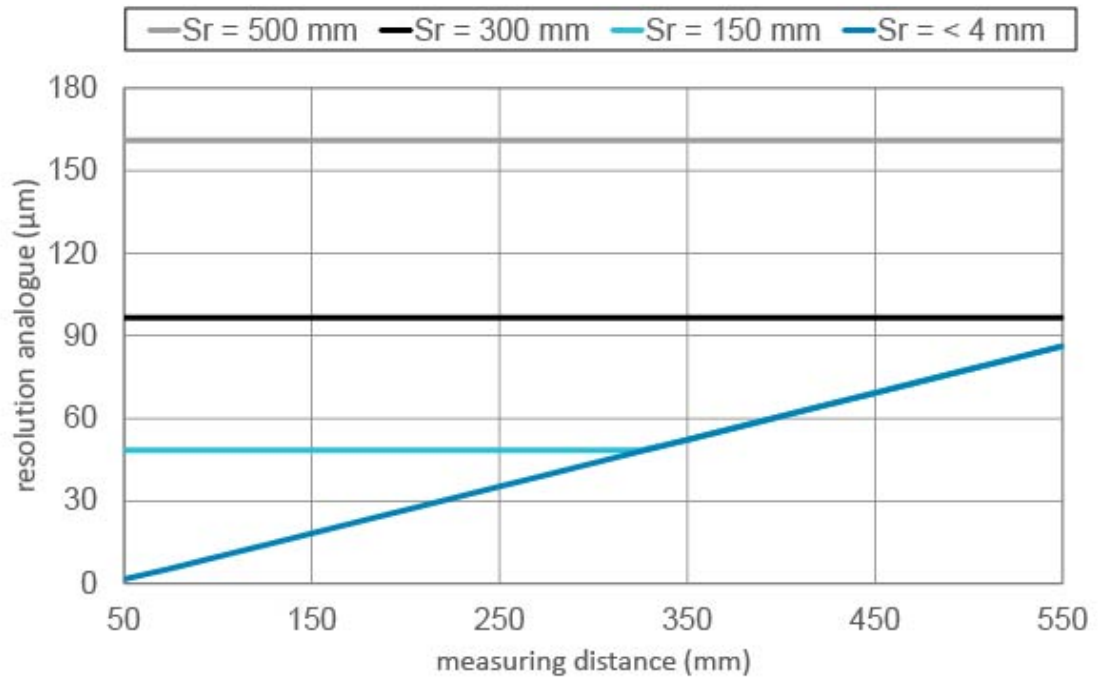

III. 27: Characteristic curves for OM30-x0550.xx.Yxx

List of illustrations

III. 1	Name plate	5
III. 2	Structure OM20/OM30	9
III. 3	Analog measurement field (inverted)	12
III. 4	Dimensional drawing OM20	17
III. 5	Dimensional drawing OM30	17
III. 6	<i>Moving Median</i> filter	24
III. 7	Moving Average filter	25
III. 8	Invalid Value Handling – example 1	29
III. 9	Invalid Value Handling – example 2	30
III. 10	Sensor in the point mode measurement mode	31
III. 11	Sensor in the window mode measurement mode	31
III. 12	Polarity – Active High	32
III. 13	Polarity – Active Low	32
III. 14	Positive hysteresis	33
III. 15	Negative hysteresis	33
III. 16	Behavior of the switching output in point mode (positive hysteresis)	34
III. 17	Behavior of the switching output in point mode (negative hysteresis)	34
III. 18	Behavior of the switching output in window mode (positive hysteresis)	35
III. 19	Behavior of the switching output in window mode (negative hysteresis)	35
III. 20	Analog measurement field (factory setting)	36
III. 21	Analog measurement field – inverted	36
III. 22	Response delay	40
III. 23	Characteristic curves for OM20-x0026.xx.Yxx	47
III. 24	Characteristic curves for OM20-x0120.xx.Yxx	47
III. 25	Characteristic curves for OM30-x0100.xx.Yxx	48
III. 26	Characteristic curves for OM30-x0350.xx.Yxx	48
III. 27	Characteristic curves for OM30-x0550.xx.Yxx	49