

Compact Oil Proof Type Photoelectric Sensor

BJR-F SERIES

INSTRUCTION MANUAL



Thank you for choosing our Autonics product. Please read the following safety considerations before use.

Safety Considerations

- Please observe all safety considerations for safe and proper product operation to avoid hazards.
- Warning symbol represents caution due to special circumstances in which hazards may occur.
- Warning** Failure to follow these instructions may result in serious injury or death.
- Caution** Failure to follow these instructions may result in personal injury or product damage.
- Warning**
  - Fail-safe device must be installed when using the unit with machinery that may cause serious injury or substantial economic loss. (e.g. nuclear power control, medical equipment, ships, vehicles, railways, aircraft, combustion apparatus, safety equipment, crime/disaster prevention devices, etc.)
  - Failure to follow this instruction may result in fire, personal injury, or economic loss.
  - Do not disassemble or modify the unit.
  - Failure to follow this instruction may result in fire.
  - Do not connect, repair, or inspect the unit while connected to a power source.
  - Failure to follow this instruction may result in fire.
  - Do not use the unit in the place where flammable/explosive/corrosive gas, humidity, direct sunlight, radiant heat, vibration, impact, or salinity may be present.
  - Failure to follow this instruction may result in fire or explosion.

Caution

- Use the unit within the rated specifications.
- Use dry cloth to clean the unit, and do not use water or organic solvent.
- Do not use the unit in the place where flammable/explosive/corrosive gas, humidity, direct sunlight, radiant heat, vibration, impact, or salinity may be present.

Ordering Information

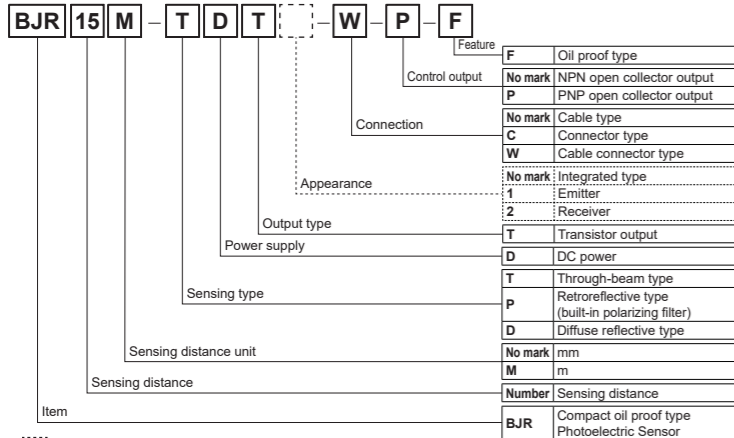

Control Output Circuit Diagram

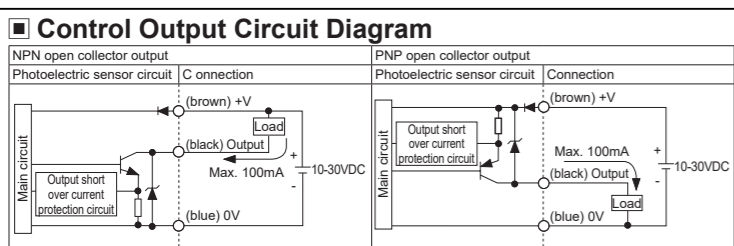

Operation Mode

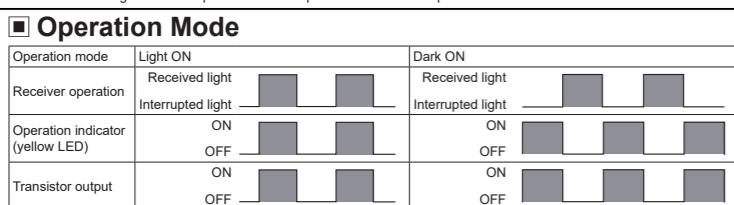

The above specifications are subject to change and some models may be discontinued without notice. Be sure to follow cautions written in the instruction manual and the technical descriptions (catalog, homepage).

Specifications

Model	BJR15M-TDT	BJR10M-TDT	BJR3M-PDT	BJR1M-DDT	BJR100-DDT
Model	NPN open collector output	NPN open collector output	Retroreflective type (built-in polarizing filter)	Diffuse reflective type	
Sensing type	Through-beam type	Through-beam type	Retroreflective type (built-in polarizing filter)	Diffuse reflective type	
Sensing distance	15m	10m	3m <sup>※1</sup>	1m <sup>※2</sup>	100mm <sup>※3</sup>
Sensing target	Opaque material over Ø12mm	Opaque material over Ø75mm	Translucent, opaque materials		
Hysteresis	—	—	Max. 20% at sensing distance		
Response time	Max. 1ms				
Power supply	10-30VDC ±10% (ripple P-P: max. 10%)				
Current consumption	Emitter / Receiver : max. 20mA / Max. 30mA				
Light source	Infrared LED (850nm)	Red LED (660nm)	Red LED (660nm)	Red LED (660nm)	Infrared LED (850nm)
Sensitivity adjustment	Sensitivity adjuster				
Operation mode	Light ON / Dark ON selectable by switch				
Control output	NPN or PNP open collector output				
Protection circuit	Power reverse polarity protection circuit, output short over current protection circuit				
Indicator	Operation indicator: yellow LED, stability indicator: green LED (emitter's power indicator: red LED)				
Connection	Cable type, connector type, cable connector type				
Insulation resistance	Over 20MΩ (at 500VDC megger)				
Noise immunity	±240V the square wave noise (pulse width: 1μs) by the noise simulator				
Dielectric strength	1,000VAC 50/60Hz for 1 minute				
Vibration	1.5mm amplitude at frequency of 10 to 55Hz (for 1 min) in each X, Y, Z direction for 2 hours				
Shock	500m/s <sup>2</sup> (approx. 50G) in each X, Y, Z direction for 3 times				
Environment	Ambient illu.: Sunlight: max. 11,000lx, incandescent lamp: max. 3,000lx (receiver illumination)				
	Ambient temp.: -25 to 60°C, storage: -40 to 70°C				
	Ambient humi.: 35 to 85%RH, storage: 35 to 85%RH				
Protection structure	IP67 (IEC standard), IP67F (JEM standard)				
Material	Case: acrylonitrile-butadiene-styrene, LED Cap: polyamide 12, sensing part: polymethyl methacrylate				
Cable	Cable type: 0.4mm, 3-wire, 2m (emitter of through-beam type: 0.4mm, 2-wire, 300mm), M12 connector (AWG26, core diameter: 0.52mm, number of cores: 20, insulator out diameter: Ø1mm)				
Connector type	M8 connector				
Cable connector type	0.4mm, 3-wire, 300mm (emitter of through-beam type: 0.4mm, 2-wire, 300mm), M12 connector (AWG26, core diameter: 0.52mm, number of cores: 20, insulator out diameter: Ø1mm)				
Accessory	Common: Mounting bracket <sup>※4</sup> , M3 bolt: 4, adjustment screwdriver. Individual: Reflector (MS-2S)				
Approval	CE				
Weight	Cable type: Approx. 145g (approx. 95g) / Approx. 115g (approx. 50g) / Approx. 100g (approx. 50g)				
	Connector type: Approx. 65g (approx. 12g) / Approx. 75g (approx. 6g) / Approx. 80g (approx. 6g)				
	Cable connector type: Approx. 105g (approx. 55g) / Approx. 95g (approx. 30g) / Approx. 80g (approx. 30g)				

※1: The sensing distance is specified with using the MS-2S reflector. The distance between the sensor and the reflector should be set over 0.1m. When using reflective tapes, the reflectivity will vary by size of the tape. Please refer to the catalog or web site.

※2: Non-glossy white paper 300×300mm. ※3: Non-glossy white paper 100×100mm.

※4: M8 connector cable is sold separately. (AWG26, core diameter: 0.52mm, number of cores: 20, insulator out diameter: Ø1mm)

※5: M12 connector cable is sold separately. (AWG22, core diameter: 0.08mm, number of cores: 60, insulator out diameter: Ø1.65mm)

※6: Cable type and cable connector type includes bracket A and connector type includes bracket B.

※7: The weight includes packaging. The weight in parenthesis is for unit only.

※The temperature or humidity mentioned in Environment indicates a non freezing or condensation.

Dimensions

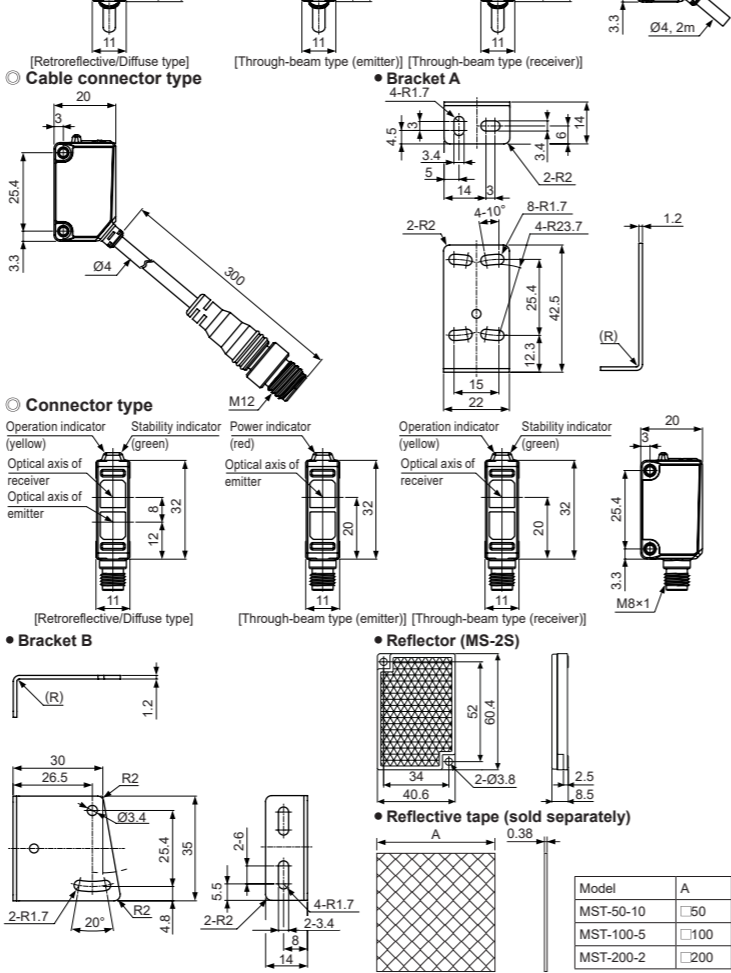

Connections

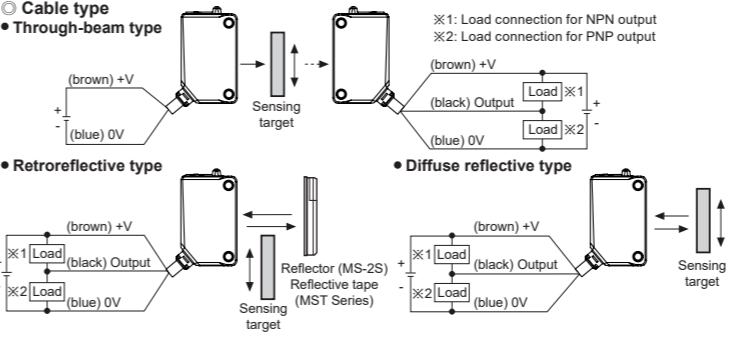

Installation and Sensitivity Adjustment

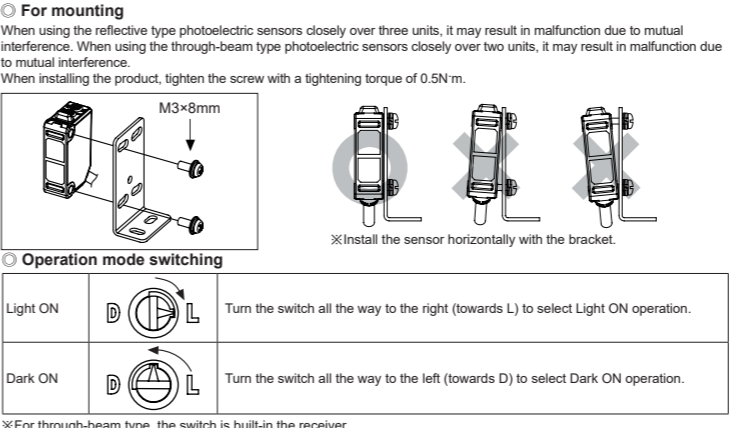

For through-beam type, the switch is built-in the receiver. Optical axis adjustment: 1. Place the emitter and the receiver facing each other and supply the power. 2. After adjusting the position of the emitter and the receiver and checking their stable indicating range, mount them in the middle of the range. 3. After mounting this unit, check the operation of the sensor and lighting of the stability indicator in both status. (none or sensing target status)

Retroreflective type: 1. Place the sensor and the reflector (or reflective tape) facing each other and supply the power. 2. After adjusting the position of the sensor and reflector (or reflective tape) and checking their stable indicating range, mount them in the middle of the range. 3. After mounting this unit, check the operation of the sensor and in both status. (none or sensing target status)

Diffuse reflective type: 1. Place the emitter and the receiver facing each other and supply the power. 2. After adjusting the position of the emitter and the receiver and checking their stable indicating range, mount them in the middle of the range. 3. After mounting this unit, check the operation of the sensor and lighting of the stability indicator in both status. (none or sensing target status)

Sensitivity setting: 1. From Light ON status, turn the sensitivity setting adjuster slowly to the right from MIN sensitivity and check the position where operation indicator turns on (A). 2. From Dark ON status, turn the sensitivity setting adjuster further right and check the position where the operation indicator turns off (C). 3. Optimum sensitivity is set at position (B). 4. If the operation indicator does not turn on at MAX sensitivity, the maximum sensitivity setting is set at position (C). 5. Set the adjuster at the center position between (A) and (C) for optimal sensitivity. Also, check if the stability indicator turns off with or without the sensing target. If it does not turn off, please review the operation mode again, as sensitivity may be unstable.

Light ON / Dark ON diagrams showing sensor, emitter, receiver, and sensing target configurations.

Please set the sensitivity setting adjuster is executed in stable Light ON area and the reliability of environment (temperature, supply, dust etc.) is increased after the mounting it in a stable area.

When adjusting sensitivity or switching operation modes, please use the Autonics adjustment screwdriver (accessory included). Using a screwdriver with a bigger diameter than the adjuster buttons may cause errors when making adjustments.

It may cause breakdown when the sensitivity setting adjuster or the operation mode selection switch is turned by force.

Connections for connector part

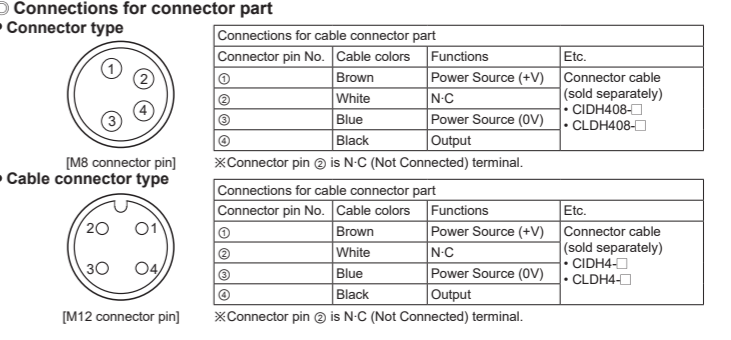

Operating Timing Diagram

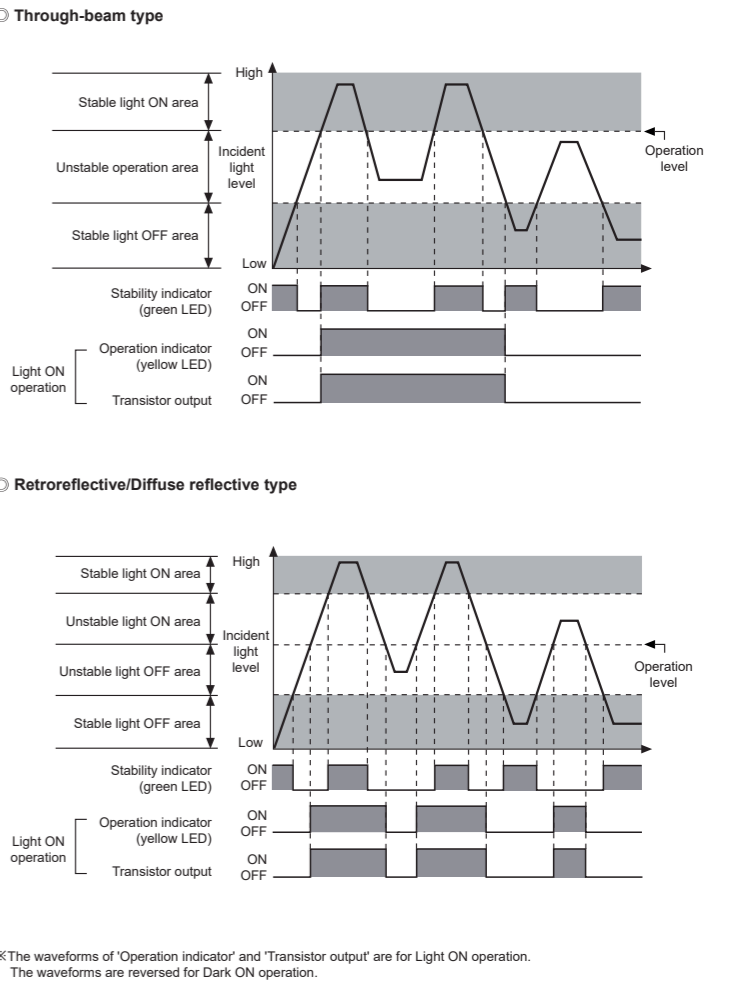

The waveforms of 'Operation indicator' and 'Transistor output' are for Light ON operation. The waveforms are reversed for Dark ON operation.

Cautions during Use

- Follow instructions in 'Cautions during Use'. Otherwise, it may cause unexpected accidents.
- When connecting a DC relay or other inductive load to the output, remove surge by using diodes or varistors.
- Use the product, 0.5 sec after supplying power.
- When using separate power supply for the sensor and load, supply power to sensor first.
- 10-30VDC power supply should be insulated and limited voltage/current or Class 2, SELV power supply device.
- Wire as short as possible and keep away from high voltage lines or power lines, to prevent inductive noise.
- When using switching mode power supply to supply the power, ground F.G. terminal and connect a condenser between 0V and F.G. terminal to remove noise.
- When using sensor with the equipment which generates noise (switching regulator, inverter, servo motor, etc.), ground F.G. terminal of the equipment.
- This unit may be used in the following environments.
  - Indoors (in the environment condition rated in 'Specifications')
  - Altitude max. 2,000m
  - Pollution degree 3
  - Installation category II

Major Products

- Photoelectric Sensors
- Fiber Optic Sensors
- Door Sensors
- Door Side Sensors
- Area Sensors
- Proximity Sensors
- Pressure Sensors
- Rotary Encoders
- Connectors/Sockets
- Switching Mode Power Supplies
- Control Switches/Lamps/Buzzers
- I/O Terminal Blocks & Cables
- Stepper Motors/Drivers/Motion Controllers
- Graphic/Logic Panels
- Field Marking System (Fiber, Co2, Nd: YAG)
- Laser Welding/Cutting System
- Temperature Controllers
- Temperature/Humidity Transducers
- SSRs/Power Controllers
- Counters
- Timers
- Panel Meters
- Tachometer/Pulse (Rate) Meters
- Display Units
- Sensor Controllers

RusAutomation  
OOO "РусАвтоматизация"  
454010 г. Челябинск, ул. Гагарина 5, оф. 507  
тел. 8-800-775-09-57 (звонок бесплатный), тел./факс (351)211-84-57  
info@rusautomation.ru; www.rusautomation.ru  
русавтоматизация.рф