



## Transit Time Ultrasonic Flow Meters

TFX Ultra





## CONTENTS

Scope of This Manual . . . . .	7
Unpacking and Inspection . . . . .	7
Safety . . . . .	7
Terminology and Symbols . . . . .	7
Considerations . . . . .	7
Quick-Start Operating Overview . . . . .	8
Transducer Location . . . . .	8
Electrical Connections . . . . .	8
Pipe Preparation and Transducer Mounting . . . . .	9
Initial Settings and Powerup . . . . .	9
Introduction . . . . .	10
Application Versatility . . . . .	10
CE Compliance . . . . .	10
User Safety . . . . .	10
Data Integrity . . . . .	10
Product Identification . . . . .	10
Transmitter Installation . . . . .	11
Transmitter Location . . . . .	11
Power Connections . . . . .	12
Transducer Installation . . . . .	15
Select a Mounting Location . . . . .	15
Select a Mounting Configuration . . . . .	17
Enter the Pipe and Liquid Parameters . . . . .	19
Mount the Transducer . . . . .	19
Transducer Mounting Configurations . . . . .	20
Inputs/Outputs . . . . .	25
General . . . . .	25
4-20 mA Output . . . . .	25
Reset Total Input . . . . .	26
Control Outputs (Flow-Only Model) . . . . .	26
Rate Alarm Outputs . . . . .	27
Frequency Output (Flow-Only Model) . . . . .	28
Totalizer Output Option (Energy Model) . . . . .	29
RS485 Port . . . . .	30

Ethernet Port . . . . .	31
USB Programming Port . . . . .	31
Heat Flow for Energy Model Only . . . . .	31
Installing Surface-Mounted RTDs . . . . .	31
Installing Insertion (Wetted) RTDs . . . . .	32
Wiring RTDs to the Transmitter . . . . .	32
Replacing RTDs . . . . .	33
Parameter Configuration Using the Keypad . . . . .	34
Startup . . . . .	35
Configuration . . . . .	35
Menu Structure . . . . .	35
Basic Menu (BSC) . . . . .	36
Channel 1 Menu (CH1) . . . . .	41
Channel 2 Menu (CH2) . . . . .	43
Options Menu . . . . .	43
Sensor Menu (SEN) . . . . .	44
Security Menu (SEC) . . . . .	44
Service Menu (SER) . . . . .	45
Service Menu (SER) continued . . . . .	46
Display Menu (DSP) . . . . .	47
Parameter Configuration Using UltraLink Software . . . . .	48
System Requirements . . . . .	48
Installation . . . . .	48
Initialization . . . . .	48
Configuration Menu . . . . .	50
Basic Tab . . . . .	50
Flow Tab . . . . .	52
Filtering Tab . . . . .	53
Output Tab . . . . .	54
Security Tab . . . . .	58
Display Tab . . . . .	58
Strategy Menu . . . . .	59
Calibration Menu . . . . .	60
Remove the Zero Offset . . . . .	60
Select Flow Rate Units . . . . .	60



Set Multiple Flow Rates . . . . .	61
UltraLink Error Codes . . . . .	62
Target Dbg Data Screen Definitions . . . . .	63
Saving the Configuration on a PC . . . . .	63
Printing a Configuration Report . . . . .	63
Menu Maps . . . . .	64
Basic Menu. . . . .	64
Channel 1 Menu . . . . .	64
Channel 2 Menu . . . . .	65
Sensor Menu . . . . .	65
Security Menu . . . . .	65
Service Menu . . . . .	65
Display Menu . . . . .	65
Communications Protocols . . . . .	66
Non-Ethernet Module Models . . . . .	66
Ethernet Module Models. . . . .	66
EtherNet/IP . . . . .	67
TCP Object (F5 <sub>HEX</sub> - 1 Instance) . . . . .	70
Ethernet Link Object (F6 <sub>HEX</sub> - 1 Instance) . . . . .	71
Reset Totalizer Object (65 <sub>HEX</sub> - 1 Instance) . . . . .	71
Modbus. . . . .	72
BACnet . . . . .	75
BACnet Configuration. . . . .	77
BACnet Object Support. . . . .	78
Annex A—Protocol Implementation Conformance Statement (Normative). . . . .	79
Annex A—Protocol Implementation Conformance Statement (Normative). . . . .	81
Ethernet Port Settings . . . . .	83
Network Settings. . . . .	87
Troubleshooting . . . . .	88
Heating and Cooling Measurement . . . . .	91
Rate of Heat Delivery . . . . .	91
In-Field Calibration of RTD Temperature Sensors . . . . .	92
Equipment Required . . . . .	92
Replacing or Re-Calibrating RTDs . . . . .	92
Brad Harrison® Connector Option . . . . .	95
Product Labels . . . . .	96

Control Drawings . . . . . 98

CE Compliance Drawings . . . . .104

K Factors . . . . .106

    Description . . . . .106

    Calculating K Factors . . . . .106

Specifications . . . . .108

    System . . . . .108

    Transducers . . . . .109

    Software Utilities . . . . .109

North American Pipe Schedules . . . . .110

Fluid Properties . . . . .115

## SCOPE OF THIS MANUAL

This manual is divided into two main sections:

- “Quick-Start Operating Overview” on page 8 is intended to help you get the TFX Ultra flow metering system up and running quickly. Refer to the detailed instructions if you require additional information.
- The remaining chapters provide a detailed description of all software settings and hardware installation guidance.

### IMPORTANT

*Read this manual carefully before attempting any installation or operation. Keep the manual accessible for future reference.*

## UNPACKING AND INSPECTION

Upon opening the shipping container, visually inspect the product and applicable accessories for any physical damage such as scratches, loose or broken parts, or any other sign of damage that may have occurred during shipment.

**NOTE:** If damage is found, request an inspection by the carrier’s agent within 48 hours of delivery and file a claim with the carrier. A claim for equipment damage in transit is the sole responsibility of the purchaser.

## SAFETY

### Terminology and Symbols



Indicates a hazardous situation, which, if not avoided, is estimated to be capable of causing death or serious personal injury.



Indicates a hazardous situation, which, if not avoided, could result in severe personal injury or death.



Indicates a hazardous situation, which, if not avoided, is estimated to be capable of causing minor or moderate personal injury or damage to property.

### Considerations

The installation of the TFX Ultra must comply with all applicable federal, state, and local rules, regulations, and codes.



**EXPLOSION HAZARD - SUBSTITUTION OF COMPONENTS MAY IMPAIR SUITABILITY FOR CLASS I, DIVISION 2.**



**RISQUE D’EXPLOSION - LA SUBSTITUTION DE COMPOSANTS PEUT RENDRE CEMATÉRIEL INACCÉPTABLE POUR LES EMPLACEMENTS DE CLASSE I, DIVISION 2.**



**DO NOT CONNECT OR DISCONNECT EITHER POWER OR OUTPUTS UNLESS THE AREA IS KNOWN TO BE NON-HAZARDOUS.**



**RISQUE D’EXPLOSION. NE PAS DÉBRANCHER TANT QUE LE CIRCUIT EST SOUSTENSION, À MOINS QU’LL NE S’AGISSE D’UN EMPLACEMENT NON DANGEREUX.**

### IMPORTANT

*Not following instructions properly may impair safety of equipment and/or personnel.*

### IMPORTANT

*Must be operated by a Class 2 supply suitable for the location.*

## QUICK-START OPERATING OVERVIEW

If you are familiar with installing TFX Ultra meters, follow these instructions to get the system up and running quickly. Refer to the detailed instructions if you require additional information.

**NOTE:** The following steps require information supplied by the transmitter itself so it will be necessary to supply power to the transmitter, at least temporarily, to obtain setup information.

### Transducer Location

- In general, select a mounting location on the piping system with a minimum of ten pipe diameters ( $10 \times$  the pipe inside diameter) of straight pipe upstream and five straight diameters downstream. See *Table 2 on page 16* for additional configurations.
- If the application requires DTTR, DTTN, DTTL or DTTH transducers, select a mounting method for the transducers based on pipe size and liquid characteristics. See *Table 3 on page 17*. The three transducer mounting configurations are shown in *Figure 1*. See “*Transducer Mounting Configurations*” on *page 20* for mounting procedures.
- Avoid installations on downward flowing pipes or pipes that may become partially filled.

**NOTE:** All DTTS and DTTT transducers use V-Mount configuration.

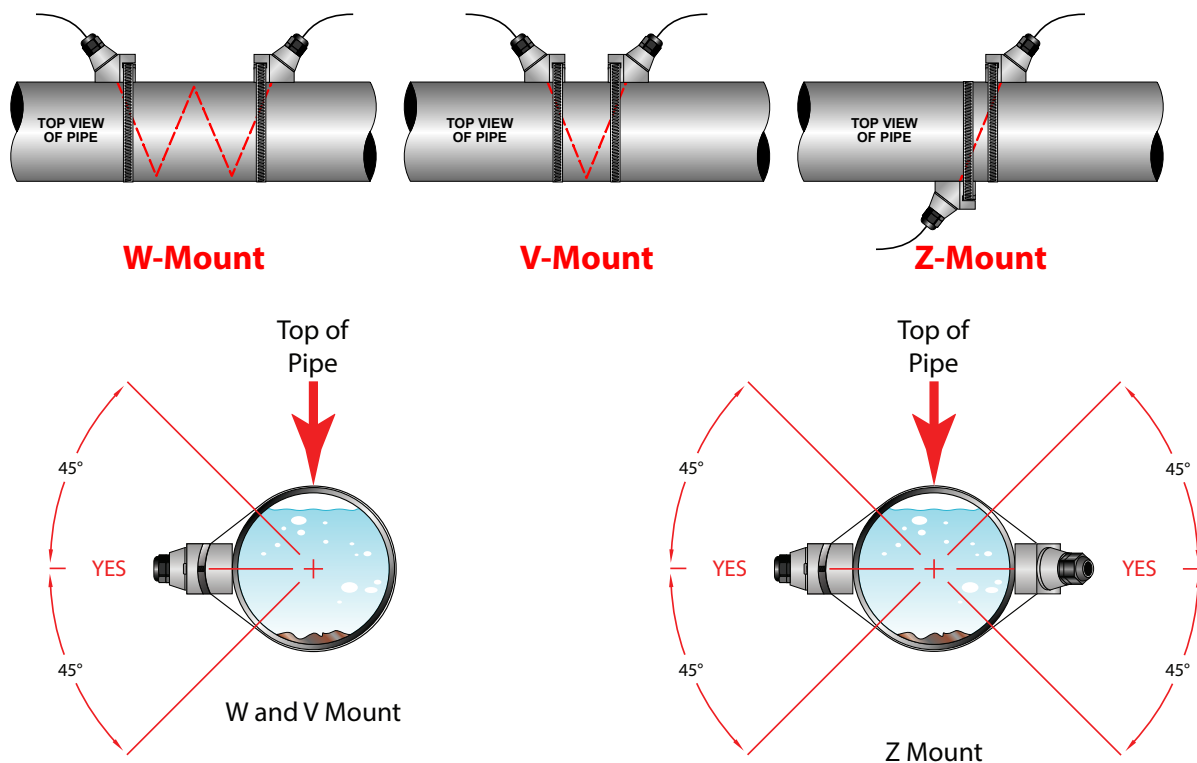

Figure 1: Transducer mounting configurations

## Electrical Connections

### Transducer/Power Connections

1. Route the transducer cables from the transducer mounting location back to the transmitter enclosure. Connect the transducer wires to the terminal block in the transmitter enclosure.
2. Verify that power supply is correct for the transmitter’s power option.
  - a. Line voltage AC transmitters require 95...264V AC, 47...63 Hz @ 17 VA maximum.
  - b. Low voltage AC transmitters require 20...28V AC, 47...63 Hz @ 0.35 VA maximum.
  - c. DC transmitters require 10...28V DC @ 5 Watts maximum.

4. Connect power to the transmitter.
5. Enter the following data into the transmitter via the integral keypad or the UltraLink software utility:

<b>1</b>	Transducer mounting method	<b>7</b>	Pipe liner thickness
<b>2</b>	Pipe O.D. (Outside Diameter)	<b>8</b>	Pipe liner material
<b>3</b>	Pipe wall thickness	<b>9</b>	Fluid type
<b>4</b>	Pipe material	<b>10</b>	Fluid sound speed*
<b>5</b>	Pipe sound speed*	<b>11</b>	Fluid viscosity*
<b>6</b>	Pipe relative roughness*	<b>12</b>	Fluid specific gravity*

**NOTE:** \* Nominal values for these parameters are included within the transmitter operating system. The nominal values may be used as they appear or may be modified if the exact system values are known.

6. Record the value calculated and displayed as transducer spacing *XDC SPAC*.

## Pipe Preparation and Transducer Mounting

### DTTR, DTTN, DTTL and DTTT Transducers

1. Place the transmitter in signal strength measuring mode. This value is available on the transmitters display *Service Menu* or in the data display of the UltraLink software utility.
2. The pipe surface, where the transducers are to be mounted, must be clean and dry. Remove scale, rust or loose paint to ensure satisfactory acoustic conduction. Wire brushing the rough surfaces of pipes to smooth bare metal may also be useful. Plastic pipes do not require preparation other than cleaning.
3. Apply a single 1/2 inch (12 mm) bead of acoustic couplant grease to the upstream transducer and secure it to the pipe with a mounting strap.
4. Apply acoustic couplant grease to the downstream transducer and press it onto the pipe using hand pressure at the lineal distance calculated in "*Transducer Location*" on page 8.
5. Space the transducers according to the recommended values found during programming or from the UltraLink software utility. Secure the transducers with the mounting straps at these locations.

### DTTS and DTTC Transducers

1. Place the transmitter in signal strength measuring mode. This value is available on the transmitter's display *Service Menu* or in the data display of the UltraLink software utility.
2. The pipe surface, where the transducers are to be mounted, must be clean and dry. Remove scale, rust or loose paint to ensure satisfactory acoustic conduction. Wire brushing the rough surfaces of pipes to smooth bare metal may also be useful. Plastic pipes do not require preparation other than cleaning.
3. Apply a single 1/2 inch (12 mm) bead of acoustic couplant grease to the top half of the transducer and secure it to the pipe with the bottom half or with U-bolts.
4. Tighten the nuts so the acoustic coupling grease begins to flow out from the edges of the transducer and from the gap between the transducer and the pipe.

## IMPORTANT

*Do not overtighten. Overtightening will not improve performance and may damage the transducer.*

## Initial Settings and Powerup

1. Apply power to the transmitter.
2. Verify that *SIG STR* is greater than 5.0.
3. Input the units of measure and the I/O data.

## INTRODUCTION

This transit time ultrasonic transmitter is designed to measure the fluid velocity of liquid within a closed conduit. The transducers are a non-contacting, clamp-on or clamp-around type, which provide the benefits of non-fouling operation and ease of installation.

This family of transit time transmitters uses two transducers that function as both ultrasonic transmitters and receivers. The transducers are clamped on the outside of a closed pipe at a specific distance from each other.

### Application Versatility

The TFX Ultra transmitter can be successfully applied on a wide range of metering applications. The simple-to-program transmitter allows the standard product to be used on pipe sizes ranging from 1/2 ... 100 inches (12...2540 mm)\*. A variety of liquid applications can be accommodated:

<b>ultrapure liquids</b>	<b>cooling water</b>	<b>potable water</b>	<b>river water</b>	<b>chemicals</b>
<b>plant effluent</b>	<b>sewage</b>	<b>reclaimed water</b>	<b>others</b>	

Because the transducers are non-contacting and have no moving parts, the transmitter is not affected by system pressure, fouling or wear.

### CE Compliance

The transmitter can be installed in conformance to CISPR 11 (EN 55011) standards. See “*CE Compliance Drawings*” on page 104.

### User Safety

The TFX Ultra transmitter employs modular construction and provides electrical safety for the operator. The display face contains voltages no greater than 28V DC. The display face swings open to allow access to user connections.

### **⚠ DANGER**

**THE POWER SUPPLY BOARD CAN HAVE LINE VOLTAGES APPLIED TO IT, SO DISCONNECT ELECTRICAL POWER BEFORE OPENING THE INSTRUMENT ENCLOSURE. WIRING SHOULD ALWAYS CONFORM TO LOCAL CODES AND THE NATIONAL ELECTRICAL CODE.**

### Data Integrity

Non-volatile flash memory retains all user-entered configuration values in memory for several years at 77° F (25° C), even if power is lost or turned off. Password protection is provided as part of the Security menu (*SEC MENU*) and prevents inadvertent configuration changes or totalizer resets.

### Product Identification

The serial number and complete model number of the transmitter are located on the top outside surface of the transmitter body. Should technical assistance be required, please provide our customer service department with this information. See “*Product Labels*” on page 96.

# TRANSMITTER INSTALLATION

## Transmitter Location

Mount the enclosure in an area that is convenient for servicing and calibration or for observing the LCD readout.

1. Locate the transmitter within the length of the transducer cables supplied or exchange the cable for one that is of proper length.
2. Mount the transmitter in a location:
  - Where little vibration exists.
  - That is protected from corrosive fluids.
  - That is within the transmitters ambient temperature limits  $-40 \dots 185^{\circ} \text{F}$  ( $-40 \dots 85^{\circ} \text{C}$ ).
  - That is out of direct sunlight. Direct sunlight may increase transmitter temperature to above the maximum limit.

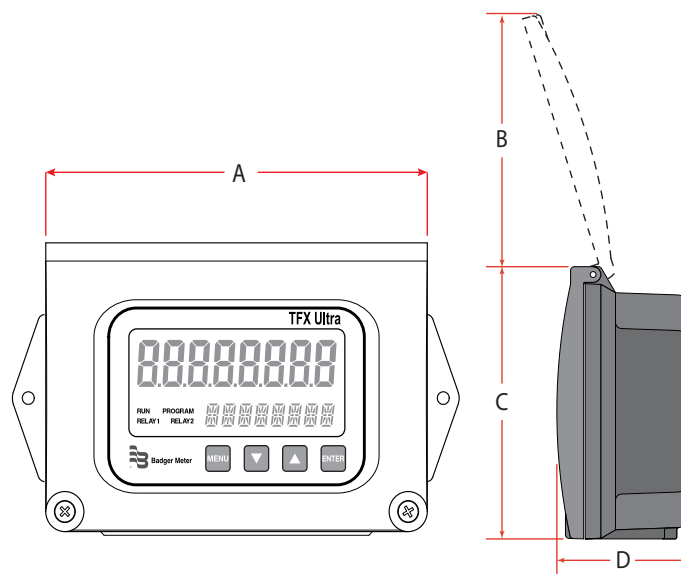

A	B	C	D
6.00 in. (152.4 mm)	4.20 in. (106.7 mm)	4.32 in. (109.7 mm)	2.06 in. (52.3 mm)

Figure 2: Transmitter enclosure dimensions

3. Refer to *Figure 2* for enclosure and mounting dimension details. Allow enough room for door swing, maintenance and conduit entrances. Secure the enclosure to a flat surface with two fasteners.
4. Use conduit holes where cables enter the enclosure from the bottom. Use plugs to seal any holes that are not used for cable entry. An optional cable gland kit (part number D010-1100-000 ) is available for inserting the transducer and power cables. Order the kit directly from the manufacturer.

**NOTE:** Use NEMA 4 (IP-65) rated fittings/plugs to maintain the watertight integrity of the enclosure. Generally, the right conduit hole (viewed from front) is used for power, the left conduit hole for transducer connections, and the center hole is used for I/O wiring.

## Power Connections

### Electrical Symbols

Function	Direct Current	Alternating Current	Earth (Ground)	Protective Ground	Chassis Ground
Symbol					

Table 1: Electrical symbols

### Transducer Connections

1. To access terminal strips for wiring, loosen the two screws in the enclosure door and open.
2. Guide the transducer terminations through the transmitter conduit hole in the bottom-left of the enclosure.
3. Secure the transducer cable with the supplied conduit nut (if flexible conduit was ordered with the transducer).
4. The terminals within transmitter are screw-down barrier terminals. Connect the wires at the corresponding screw terminals in the transmitter. Observe upstream and downstream orientation and wire polarity. See *Figure 3*.

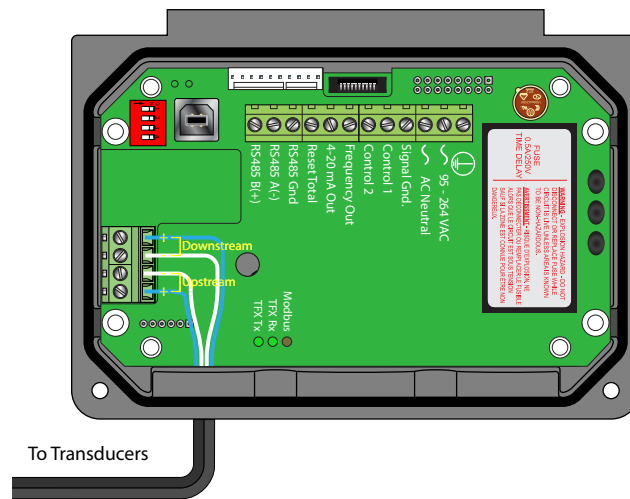

Figure 3: Transducer connections

**NOTE:** Transducer cables have two wire color combinations. For the blue and white combination, the blue wire is positive (+) and the white wire is negative (-). For the red and black combination, the red wire is positive (+) and the black wire is negative (-). The transducer wires are labeled to indicate which pair is upstream or downstream.

5. Connect power to the screw terminal block in the transmitter using the conduit hole on the right side of the enclosure. See *Figure 4* and *Figure 5*. Use wiring practices that conform to local and national codes such as The National Electrical Code Handbook in the U.S.

### **CAUTION**

**ANY OTHER WIRING METHOD MAY BE UNSAFE OR CAUSE IMPROPER OPERATION OF THE TRANSMITTER.**

**NOTE:** This transmitter requires clean electrical line power. Do not operate this transmitter on circuits with noisy components (such as fluorescent lights, relays, compressors, or variable frequency drives). Do not use step-down transformers from high voltage, high amperage sources. Do not to run signal wires with line power within the same wiring tray or conduit.



### Line Voltage AC Power Connections

Connect 95...264V AC, AC neutral and chassis ground to the terminals shown in *Figure 4*. Do not operate without an earth (chassis) ground connection.

### IMPORTANT

Permanently connected equipment and multi-phase equipment uses a switch or circuit breaker as a means of disconnect. The switch or circuit breaker conforms to the following:

- A switch or circuit breaker is included in the building installation.
- The switch is in close proximity to the equipment and within easy reach of the operator.
- The switch is marked as the disconnecting device for the equipment.

Wiring of this equipment in ordinary locations must be in accordance with ANSI/NFPA 70, National Electrical Code (NEC), Canadian Electrical Code (CEC) or IEC 60364 as required by local codes. Wiring of this equipment in hazardous locations requires special considerations such as those described in National Electrical Code (NEC) Article 500, Canadian Electrical Code (CEC), CSA C22.1 or IEC 60079-14.

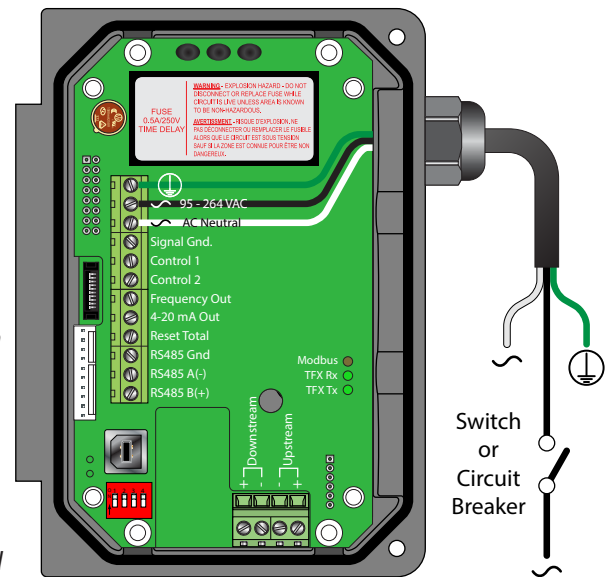

Figure 4: Line voltage AC power connections

### Low Voltage AC Power Connections

Connect 20...28V AC, AC neutral and chassis ground to the terminals shown in *Figure 5*.

**⚠ DANGER**

**DO NOT OPERATE WITHOUT AN EARTH (CHASSIS) GROUND CONNECTION.**

The 24V AC power supply option for this transmitter is intended for a typical HVAC and Building Control Systems (BCS) powered by a 24V AC, nominal, power source. This power source is provided by AC line power to 24V AC drop-down transformer and is installed by the installation electricians.

**NOTE:** In electrically noisy applications, grounding the transmitter to the pipe where the transducers are mounted may provide additional noise suppression. This approach is only effective with conductive metal pipes. The earth (chassis) ground derived from the line voltage power supply should be removed at the transmitter and a new earth ground connected between the transmitter and the pipe being measured.

**NOTE:** Wire gauges up to 14 AWG can be accommodated in the transmitter terminal blocks.

**NOTE:** AC-powered transmitters are protected by a field-replaceable fuse. The fuse is a time delay fuse rated at 0.5A/250V and is equivalent to Wickmann P.N. 3720500041 or 37405000410.

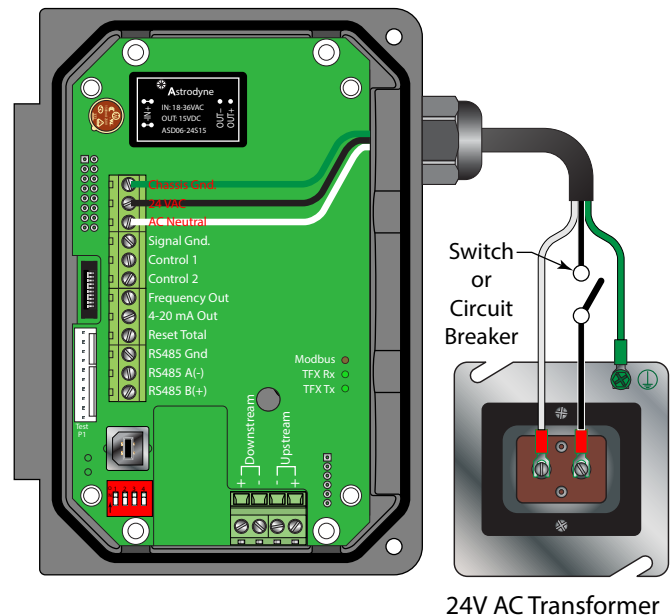

Figure 5: Low voltage AC power connections

### DC Power Connections

The transmitter may be operated from a 10...28V DC source, as long as the source is capable of supplying a minimum of 5 Watts of power.

Connect the DC power to 10...28V DC In, power ground, and chassis ground, as in *Figure 6*.

**NOTE:** DC-powered transmitters are protected by an automatically resetting fuse. This fuse does not require replacement.

For CE compliance, a Class 2 DC power supply is required.

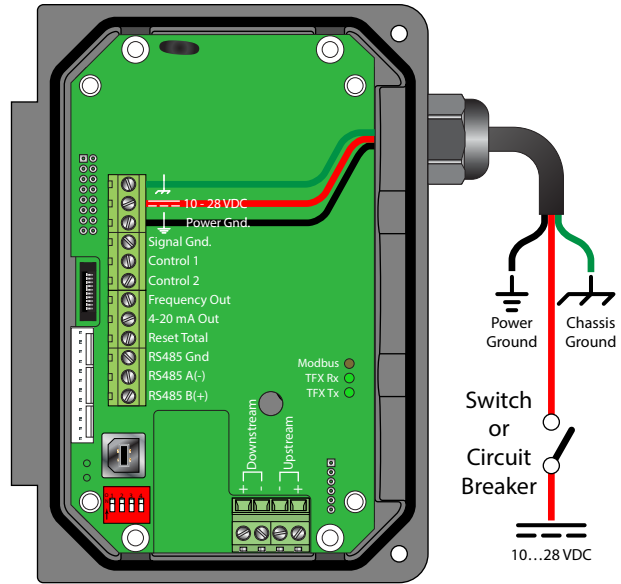

Figure 6: DC power connections

## TRANSDUCER INSTALLATION

The transducers for the TFX Ultra transmitter contain piezoelectric crystals that transmit and receive ultrasonic signals through the walls of liquid piping systems.

DTTR, DTTN, DTTL and DTTH transducers are relatively simple and straightforward to install, but spacing and alignment of the transducers is critical to the system's accuracy and performance. **CAREFULLY EXECUTE THESE INSTRUCTIONS.**

DTTS and DTTC small pipe transducers have integrated transmitter and receiver elements that eliminate the requirement for spacing measurement and alignment.

Mounting the DTTR, DTTN, DTTL and DTTH clamp-on ultrasonic transit time transducers takes five steps:

1. Select the optimum location on a piping system.
2. Select a mounting configuration.
3. Enter the pipe and liquid parameters into the UltraLink software utility or key them into the transmitter. The UltraLink software utility or the transmitter's firmware calculates proper transducer spacing based on these entries.
4. Prepare the pipe and mount the transducers.
5. Wire the transducers to the transmitter.

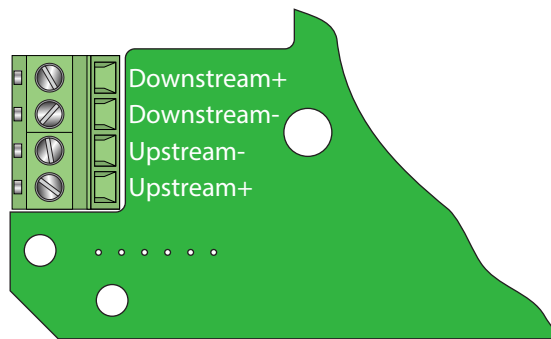

Figure 7: Transducer connections

The Energy model transmitter requires two 1000 Ohm, three-wire, platinum RTDs. The RTDs are available in surface-mount and insertion (wetted) styles. Use surface-mount RTDs on well insulated pipes. Use insertion RTDs on non-insulated pipes.

### Select a Mounting Location

The first step in the installation process is the selection of an optimum location for the flow measurement to be made. For this to be done effectively, a basic knowledge of the piping system and its plumbing are required.

An optimum location is defined as:

- A piping system that is completely full of liquid when measurements are being taken. The pipe may become completely empty during a process cycle, which will result in the error code 0010 (Low Signal Strength) displaying on the transmitter while the pipe is empty. This error code will clear automatically once the pipe refills with liquid. Do not mount the transducers in an area where the pipe may become partially filled, such as the highest point in a flow loop. Partially filled pipes will cause erroneous and unpredictable operation of the transmitter.
- A piping system that contains lengths of straight pipe such as those described in *Table 2*. The optimum straight pipe diameter recommendations apply to pipes in both horizontal and vertical orientation. The straight runs in *Table 2* apply to liquid velocities that are nominally 7 fps (2.2 mps). As liquid velocity increases above this nominal rate, the requirement for straight pipe increases proportionally.
- An area where the transducers will not be inadvertently bumped or disturbed during normal operation.
- NOT on downward flowing pipes unless adequate downstream head pressure is present to overcome partial filling of or cavitation in the pipe.

Piping Configuration and Transducer Positioning	Upstream Pipe Diameters	Downstream Pipe Diameters
	*	**
	14	5
	10	5
	10	5
	10	5
	24	5

Table 2: Piping configuration and transducer positioning

The TFX Ultra system will provide repeatable measurements on piping systems that do *not* meet these pipe diameter requirements, but the accuracy of the readings may be influenced.

## Select a Mounting Configuration

The transmitter can be used with six different transducer types: DTTR, DTTN, DTTL, DTTH, DTTS and DTTC. Meters that use the DTTR, DTTN, DTTL or DTTH, transducer sets consist of two separate sensors that function as both ultrasonic transmitters and receivers. These transducers are clamped on the outside of a closed pipe at a specific distance from each other. DTTS and DTTC transducers integrate both the transmitter and receiver into one assembly that fixes the separation of the piezoelectric crystals.

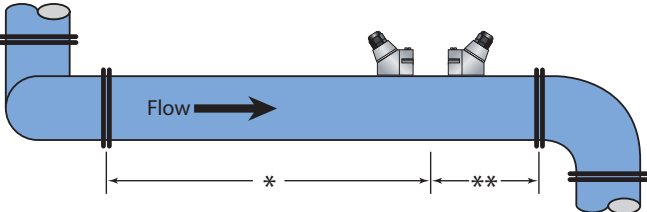
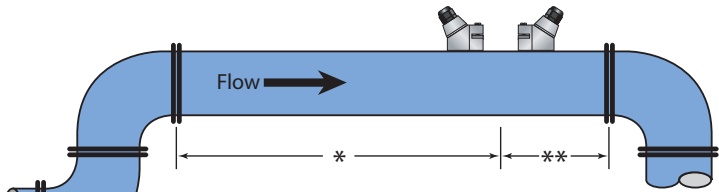
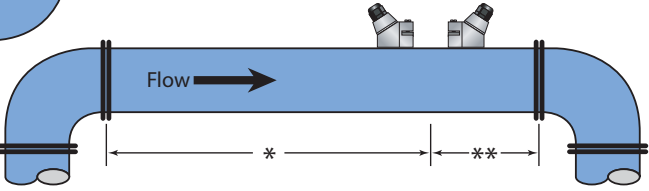
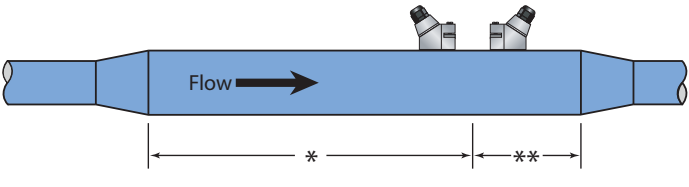
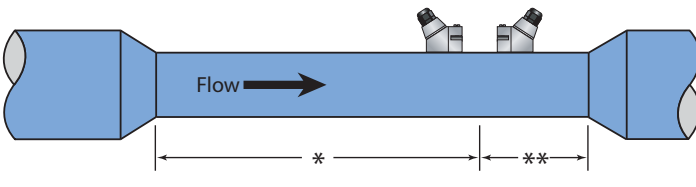
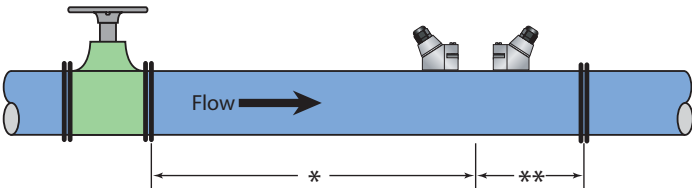
The DTTR, DTTN, DTTL and DTTH transducers can be mounted in:

- **W-Mount** where the sound traverses the pipe four times. This mounting method produces the best relative travel time values but the weakest signal strength.
- **V-Mount** where the sound traverses the pipe twice. **V-Mount** is a compromise between travel time and signal strength.
- **Z-Mount** where the transducers are mounted on opposite sides of the pipe and the sound crosses the pipe once. **Z-Mount** will yield the best signal strength but the smallest relative travel time.

Transducer Mounting Configuration	Pipe Material	Pipe Size	Liquid Composition
<b>W-Mount</b>	Plastic (all types)	2...4 in. (50...100 mm)	Low TSS (Total Suspended Solids); non-aerated
	Carbon Steel		
	Stainless Steel		
	Copper		
	Ductile Iron	Not recommended	
	Cast Iron		
<b>V-Mount</b>	Plastic (all types)	4...12 in. (100...300 mm)	
	Carbon Steel		
	Stainless Steel		
	Copper	2...12 in. (50...300 mm)	
	Ductile Iron		
	Cast Iron		
<b>Z-Mount</b>	Plastic (all types)	> 30 in. (> 750 mm)	
	Carbon Steel	> 12 in. (> 300 mm)	
	Stainless Steel		
	Copper	> 30 in. (> 750 mm)	
	Ductile Iron	> 12 in. (> 300 mm)	
	Cast Iron		

Table 3: Transducer mounting modes for DTTR, DTTN, DTTL and DTTH

The transducers can be mounted in V-Mount where the sound transverses the pipe two times, W-Mount where the sound transverses the pipe four times, or in Z-Mount where the transducers are mounted on opposite sides of the pipe and the sound crosses the pipe once. The selection of mounting method is based on pipe and liquid characteristics which both have an effect on how much signal is generated. The transmitter operates by alternately transmitting and receiving a frequency modulated burst of sound energy between the two transducers and measuring the time interval that it takes for sound to travel between the two transducers. The difference in the time interval measured is directly related to the velocity of the liquid in the pipe.

The appropriate mounting configuration is based on pipe and liquid characteristics. Selecting the proper transducer mounting method is an iterative process. Table 3 contains recommended mounting configurations for common applications. These recommended configurations may need to be modified for specific applications if such things as aeration, suspended solids, out-of-round piping or poor piping conditions are present.

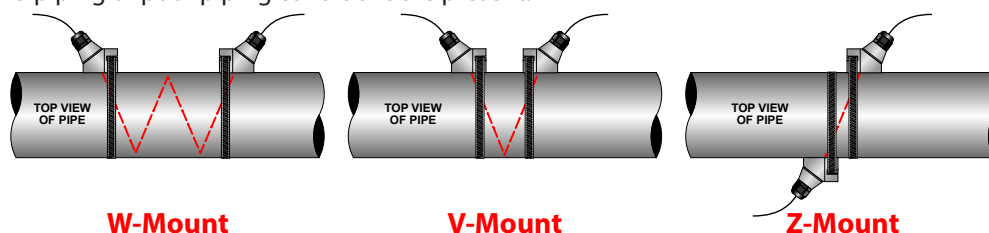

Figure 8: Transducer mounting modes for DTTR, DTTN, DTTL and DTTH

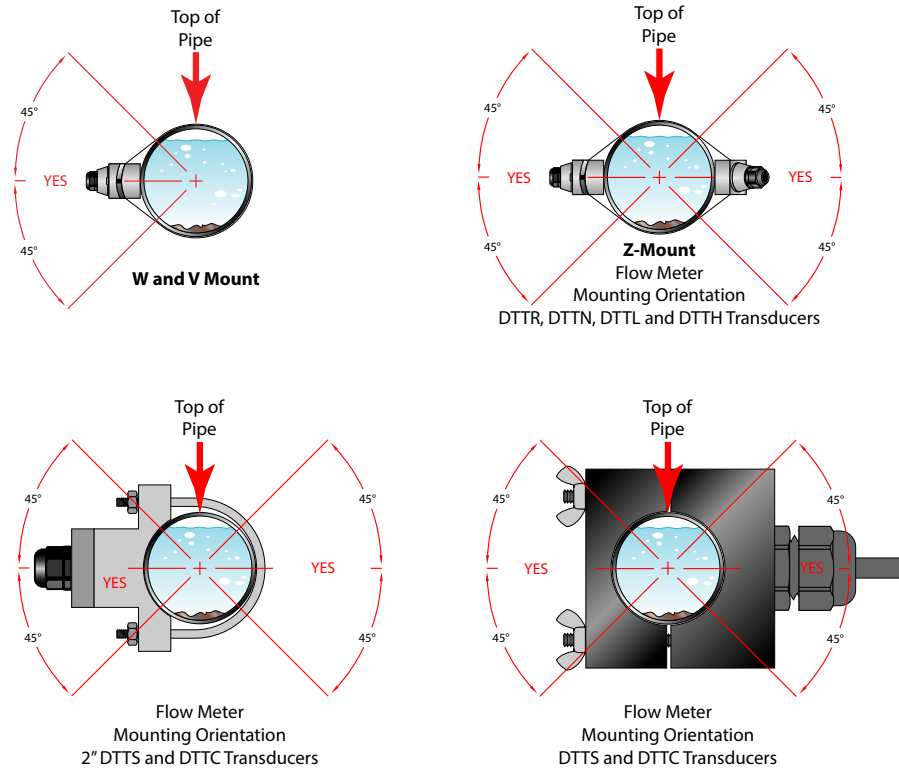

Figure 9: Transducer orientation for horizontal pipes

For pipes 24 inches (600 mm) and larger, use the DTTL transducers with a transmission frequency of 500 kHz.

DTTL transducers may also be advantageous on pipes between 4...24 inches if there are less quantifiable complicating aspects, such as sludge, tuberculation, scale, rubber liners, plastic liners, thick mortar, gas bubbles, suspended solids, emulsions, or pipes that are partially buried where a V-mount is required or desired.

For DTTS and DTTC transducers, the transducers are V-mount. The frequency setting depends on the pipe material.

Pipe Size	Frequency Setting	Transducer	Integral Transducer	Pipe	Mounting Configuration
1/2 in.	2 MHz	DTTSnP	DTFXn-A	ANSI	V
		DTTSnC	DTFXn-G	Copper	
		DTTSnT	DTFXn-M	Stainless Steel	
3/4 in.	2 MHz	DTTSnP	DTFXn-B	ANSI	
		DTTSnC	DTFXn-H	Copper	
		DTTSnT	DTFXn-N	Stainless Steel	
1 in.	2 MHz	DTTSnP	DTFXn-C	ANSI	
		DTTSnC	DTFXn-I	Copper	
		DTTSnT	DTFXn-P	Stainless Steel	
1-1/4 in.	2 MHz	DTTSnP	DTFXn-D	ANSI	
		DTTSnC	DTFXn-J	Copper	
		DTTSnT	DTFXn-Q	Stainless Steel	
1-1/2 in.	2 MHz	DTTSnP	DTFXn-E	ANSI	
		DTTSnC	DTFXn-K	Copper	
		DTTSnT	DTFXn-R	Stainless Steel	
2 in.	1 MHz	DTTSnP	DTFXn-F	ANSI	
		DTTSnC	DTFXn-L	Copper	
	2 MHz	DTTSnT	DTFXn-S	Stainless Steel	

DTTS transducer designation refers to both DTTS and DTTC transducer types.

Table 4: Transducer mounting modes for DTTS / DTTC

## Enter the Pipe and Liquid Parameters

The TFX Ultra metering system calculates proper transducer spacing based on the piping and liquid information you enter into the transmitter via the integral keypad or the UltraLink software utility.

The most accuracy is achieved when the transducer spacing is exactly what the transmitter calculates, so use the calculated spacing if the signal strength is satisfactory. If the pipe is not round, the wall thickness not correct or the actual liquid being measured has a different sound speed than the liquid programmed into the transmitter, the spacing can vary from the calculated value. In that case, place the transducers at the highest signal level observed when moving the transducers slowly around the mount area.

**NOTE:** Transducer spacing is calculated on “ideal” pipe. Ideal pipe almost never exists, so you may need to alter the transducer spacing. An effective way to maximize signal strength is to configure the display to show signal strength, fix one transducer on the pipe and then—starting at the calculated spacing—move the remaining transducer small distances forward and back to find the maximum signal strength point.

### IMPORTANT

Enter all of the data on this list, save the data and reset the transmitter before mounting the transducers.

The following information is required before programming the instrument:

Transducer mounting configuration	Pipe liner thickness (if present)	Pipe O.D. (outside diameter)	Pipe liner material (if present)
Pipe wall thickness	Fluid type	Pipe material	Fluid sound speed <sup>1</sup>
Pipe sound speed <sup>1</sup>	Fluid viscosity <sup>1</sup>	Pipe relative roughness <sup>1</sup>	Fluid specific gravity <sup>1</sup>

Table 5: Parameters required

<sup>1</sup>Nominal values for these parameters are included within the transmitter’s operating system. The nominal values may be used as they appear or may be modified if exact system values are known.

**NOTE:** Much of the data relating to material sound speed, viscosity and specific gravity is pre-programmed into the transmitter. You need to modify this data only if you know that a particular application’s data varies from the reference values. See “Configuration” on page 35 for instructions on entering configuration data into the transmitter via the transmitter’s keypad. See “Parameter Configuration Using UltraLink Software” on page 48 for data entry via the software.

After entering the data listed above, the transmitter will calculate proper transducer spacing for the particular data set. The distance will be in inches if the transmitter is configured in English units, or millimeters if configured in metric units.

## Mount the Transducer

After selecting an optimal mounting location and determining the proper transducer spacing, mount the transducers onto the pipe.

1. Clean the surface of the pipe. If the pipe has external corrosion or dirt, wire brush, sand or grind the mounting location until it is smooth and clean. Paint and other coatings, if not flaked or bubbled, need not be removed. Plastic pipes typically do not require surface preparation other than soap and water cleaning.
2. Orient and space the DTTR, DTTN, DTTL and DTTH transducers on the pipe to provide optimum reliability and performance. On horizontal pipes, when Z-Mount is required, mount the transducers 180 radial degrees from one another and at least 45 degrees from the top-dead-center and bottom-dead-center of the pipe. See Figure 9. Also see “Z-Mount Configuration” on page 22. On vertical pipes, the orientation is not critical.

The spacing between the transducers is measured between the two spacing marks on the sides of the transducers. These marks are approximately 0.75 inches (19 mm) back from the nose of the DTTR, DTTN and DTTH transducers, and 1.2 inches (30 mm) back from the nose of the DTTL transducers. See Figure 10.

Mount DTTS and DTTC transducers with the cable exiting within ±45 degrees of the side of a horizontal pipe. On vertical pipes, the orientation does not apply.

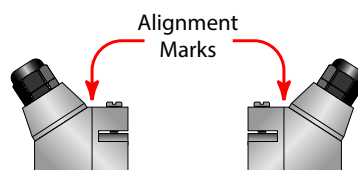

Figure 10: Transducer alignment marks

## Transducer Mounting Configurations

### V-Mount and W-Mount Configurations

#### Apply the Couplant

For DTTR, DTTN, DTTL and DTTH transducers, place a single bead of couplant, approximately 1/2 inch (12 mm) thick, on the flat face of the transducer. See *Figure 11*. Couplant is provided with the transducers. Generally, a silicone-based grease is used as an acoustic couplant, but any good quality grease-like substance that is rated to not flow at the operating temperature of the pipe is acceptable. For pipe surface temperature over 130° F (55° C), use high temperature acoustic couplant such as Krytox® LVP (P.N. D002-2011-012). For installations that must be silicone free, use Molykote G-N couplant (P.N. D002-2011-009).

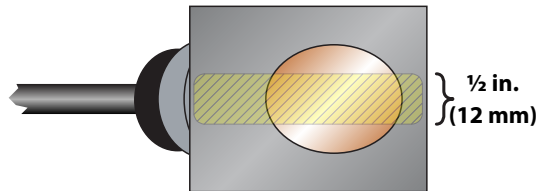

Figure 11: Application of couplant

#### Position and Secure the Transducer

1. Place the upstream transducer in position on the pipe. Slide the strap into the arched groove on the end of the transducer. Wrap the strap around the pipe. Slide the free end of the strap into the end clip of the strap with the screw at 90 degrees to the strap. Pull the strap through until it loosely fits around the pipe. Rotate the screw so it is parallel to the strap and tighten the screw slightly to help hold the transducer onto the pipe. Verify that the transducer is true to the pipe and adjust as necessary. Tighten the strap screw to secure the transducer to the pipe.
  2. Place the downstream transducer on the pipe at the calculated transducer spacing. See *Figure 12 on page 21*. Apply firm hand pressure. If signal strength is greater than five, secure the transducer at this location. If the signal strength is not five or greater, using firm hand pressure slowly move the transducer both towards and away from the upstream transducer while observing signal strength. Signal strength can be displayed on the transmitter's display or on the main data screen in the UltraLink software utility. See *"Parameter Configuration Using UltraLink Software" on page 48*. Clamp the transducer at the position where the highest signal strength is observed. The factory default signal strength setting is five. However, there are many application-specific conditions that may prevent the signal strength from attaining this level. Signal levels less than five will probably not be acceptable for reliable readings.
- NOTE:** Signal strength readings update only every few second. Move the transducer 1/8 inch then wait to see if the signal is increasing or decreasing. Repeat until the highest level is achieved.
3. If, after adjusting the transducers, the signal strength does not rise to above five, use an alternate transducer mounting configuration. If the mounting configuration was **W**-Mount, re-configure the transmitter for **V**-Mount, move the downstream transducer to the new spacing distance and repeat the procedure *"Mount the Transducer" on page 19*.



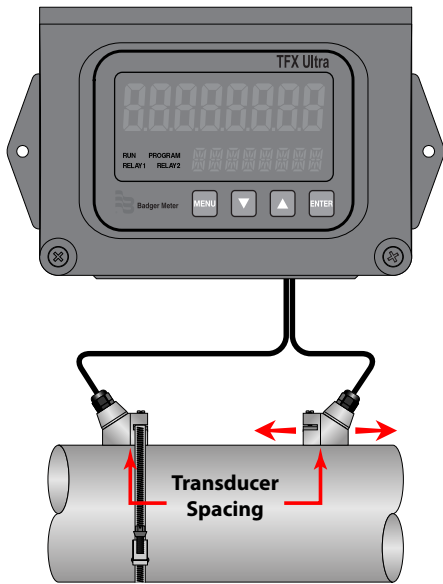

Figure 12: Transducer positioning

**NOTE:** Mounting the high temperature transducers is similar to mounting the DTTR/DTTN/DTTL transducers. High temperature installations require acoustic couplant that is rated not to flow at the operating temperature of the pipe surface.

**NOTE:** Use the DTTL on pipes 24 inches and larger and not on pipes smaller than 4 inches. You can consider using the DTTL transducers on pipes smaller than 24 inches if there are less quantifiable aspects—such as sludge, tuberculation, scale, rubber liners, plastic liners, thick mortar liners, gas bubbles, suspended solids, emulsions—and smaller pipes that are perhaps partially buried where a V-Mount is required or desired.

#### DTTS/DTTC Small Pipe Transducer Installation

The small pipe transducers are designed for specific pipe outside diameters. Do not attempt to mount a DTTS/DTTC transducer onto a pipe that is either too large or too small for the transducer. Instead, contact the manufacturer to arrange for a replacement transducer that is the correct size.

1. Apply a thin coating of acoustic coupling grease to both halves of the transducer housing where the housing will contact the pipe. See Figure 13.
2. On horizontal pipes, mount the transducer in an orientation so the cable exits at  $\pm 45$  degrees from the side of the pipe. Do not mount with the cable exiting on either the top or bottom of the pipe. On vertical pipes, the orientation does not matter.
3. Tighten the wing nuts or U-bolts so the acoustic coupling grease begins to flow out from the edges of the transducer or from the gap between the transducer halves.

#### IMPORTANT

*Do not overtighten. Overtightening will not improve performance and may damage the transducer.*

4. If signal strength is less than five, remount the transducer at another location on the piping system.

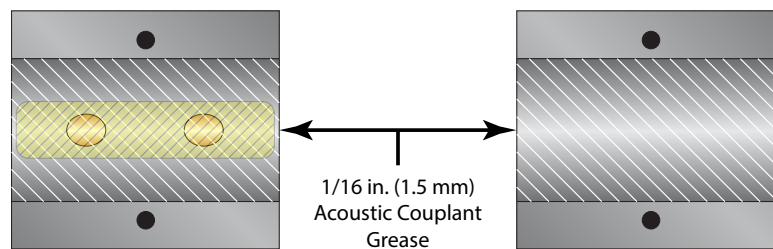

Figure 13: Application of acoustic couplant — DTTS/DTTC transducers

**NOTE:** If a DTTS/DTTC small pipe transducer was purchased separately from the transmitter, the following configuration procedure is required.

*DTTS/DTTC Small Pipe Transducer Calibration Procedure*

1. Establish communications with the transit time transmitter.
2. From the tool bar, select **Calibration**. See *Figure 16*.
3. On the pop-up screen, click **Next** twice to get to *Page 3 of 3*. See *Figure 14*.
4. Click **Edit**.
5. If a calibration point is displayed in *Calibration Points Editor*, record the information, then highlight and click **Remove**. See *Figure 15*.
6. Click **ADD...**
7. Enter Delta T, Un-calibrated Flow, and Calibrated Flow values from the DTTS/DTTC calibration label, then click **OK**. See *Figure 17*.
8. Click **OK** in the *Edit Calibration Points* screen.
9. The display will return to *Page 3 of 3*. Click **Finish**. See *Figure 14*.
10. After *Writing Configuration File* is complete, turn off the power. Turn on the power again to activate the new settings.

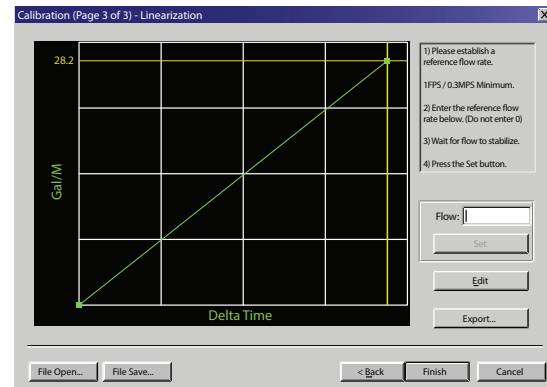

Figure 14: Calibration points editor

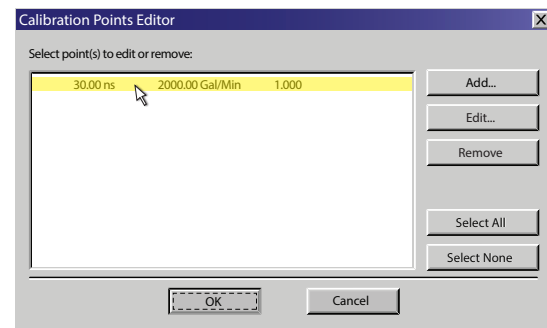

Figure 15: Calibration page 3 of 3

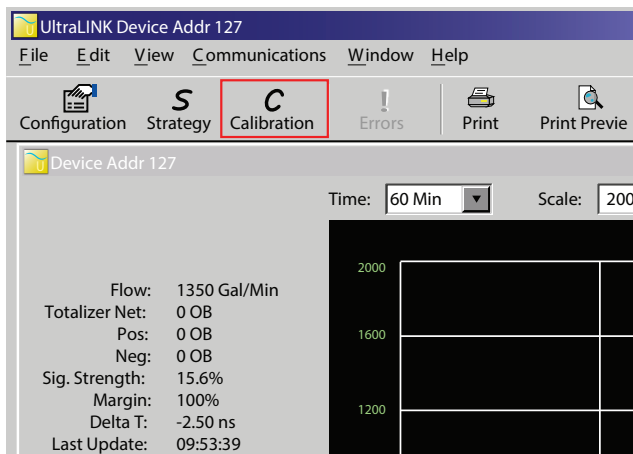

Figure 16: Data display screen

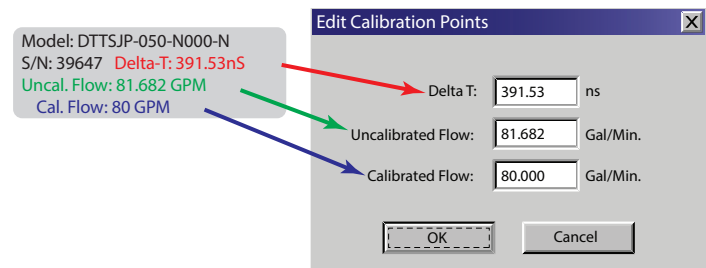

Figure 17: Edit calibration points

**Z-Mount Configuration**

Installation on larger pipes requires careful measurements of the linear and radial placement of the DTTR, DTTN, DTTL and DTTT transducers. Failure to properly orient and place the transducers on the pipe may lead to weak signal strength and/or inaccurate readings. This section details a method for properly locating the transducers on larger pipes. This method requires a roll of paper such as freezer paper or wrapping paper, masking tape and a marking device.

1. Wrap the paper around the pipe in the manner shown in *Figure 18*. Align the paper ends to within 1/4 inch (6 mm).
2. Mark the intersection of the two ends of the paper to indicate the circumference. Remove the template and spread it out on a flat surface. Fold the template in half, bisecting the circumference. See *Figure 19*.
3. Crease the paper at the fold line. Mark the crease. Place a mark on the pipe where one of the transducers will be located. See *Figure 9* for acceptable radial orientations. Wrap the template back around the pipe, placing the beginning of the paper and one corner in the location of the mark. Move to the other side of the pipe and mark the pipe at the ends of the crease. Measure from the end of the crease (directly across the pipe from the first transducer location) the dimension derived in *"Select a Mounting Configuration"* on page 17. Mark this location on the pipe.

- The two marks on the pipe are now properly aligned and measured. If access to the bottom of the pipe prohibits the wrapping of the paper around the circumference, cut a piece of paper 1/2 the circumference of the pipe and lay it over the top of the pipe. The equation for the length of 1/2 the circumference is:  $1/2 \text{ Circumference} = \text{Pipe O.D.} \times 1.57$

The transducer spacing is the same as found in "Position and Secure the Transducer" on page 20. Mark opposite corners of the paper on the pipe. Apply transducers to these two marks.

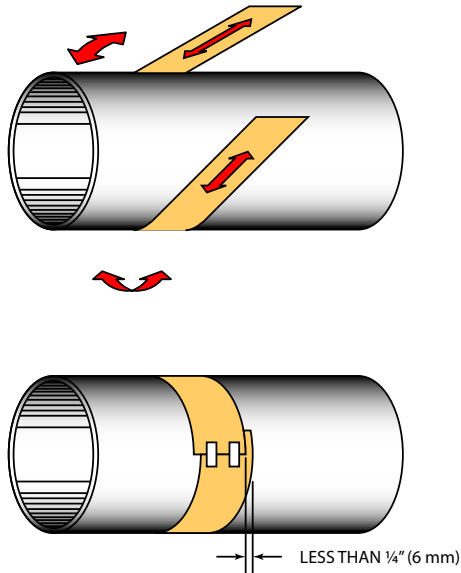

Figure 18: Paper template alignment

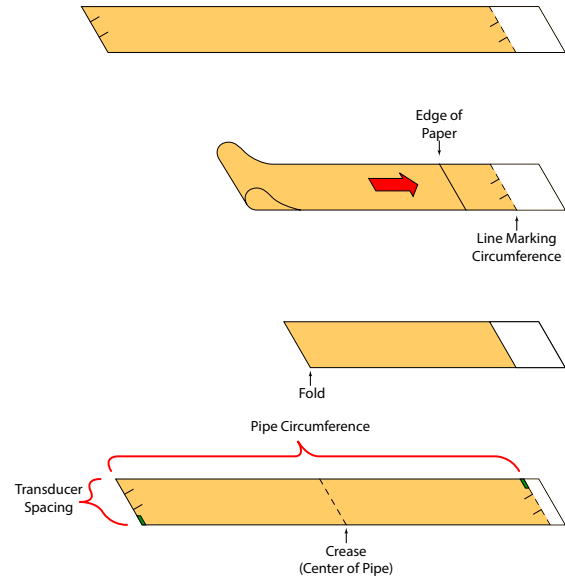

Figure 19: Bisecting the pipe circumference

- For DTTR, DTTN, D TTL and DTTH transducers, place a single bead of couplant, approximately 1/2 inch (12 mm) thick, on the flat face of the transducer. See Figure 11. Generally, a silicone-based grease is used as an acoustic couplant, but any good quality grease-like substance that is rated to not flow at the operating temperature of the pipe is acceptable.
- Place the upstream transducer in position and secure with a stainless steel strap or other fastening device. Straps should be placed in the arched groove on the end of the transducer. A screw is provided to help hold the transducer onto the strap. Verify that the transducer is true to the pipe, adjust as necessary. Tighten transducer strap securely. Larger pipes may require more than one strap to reach the circumference of the pipe.

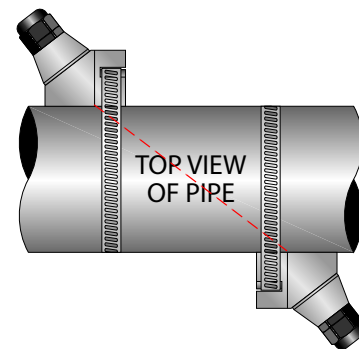

Figure 20: Z-Mount transducer placement

- Place the downstream transducer on the pipe at the calculated transducer spacing. See Figure 20. Using firm hand pressure, slowly move the transducer both towards and away from the upstream transducer while observing signal strength. Clamp the transducer at the position where the highest signal strength is observed. A signal strength between 5...98 is acceptable.

The factory default signal strength setting is five. However there are many application-specific conditions that may prevent the signal strength from attaining this level. A minimum signal strength of five is acceptable as long as this signal level is maintained under all flow conditions.

On certain pipes, a slight twist to the transducer may cause signal strength to rise to acceptable levels. Certain pipe and liquid characteristics may cause signal strength to rise to greater than 98. The problem with operating this transmitter with very high signal strength is that the signals may saturate the input amplifiers and cause erratic readings. Strategies for lowering signal strength would be changing the transducer mounting method to the next longest transmission path. For example, if there is excessive signal strength and the transducers are mounted in a Z-Mount, try changing to V-Mount or W-Mount. Finally, you can also move one transducer slightly off-line with the other transducer to lower signal strength.

- Secure the transducer with a stainless steel strap or other fastener.

### Mounting Rail System Installation for DTTR

For remote flow DTTR transducers with outside diameters between 2...10 inches (50...250 mm) , the rail mounting kit aids in installation and positioning of the transducers. Transducers slide on the rails, which have measurement markings that are viewable through the sight opening.

1. Install the single mounting rail on the side of the pipe with the stainless steel bands provided. Do not mount it on the top or bottom of the pipe. On vertical pipe, orientation is not critical. Check that the track is parallel to the pipe and that all four mounting feet are touching the pipe.
2. Slide the two transducer clamp brackets toward the center mark on the mounting rail.
3. Place a single bead of couplant, approximately 1/2 inch (12 mm) thick, on the flat face of the transducer.  
See *Figure 11* on page 20.
4. Place the first transducer in between the mounting rails near the zero point on the scale. Slide the clamp over the transducer. Adjust the clamp and transducer so the notch in the clamp aligns with the zero on the scale. See *Figure 22*.
5. Secure with the thumb screw. Check that the screw rests in the counter bore on the top of the transducer. (Excessive pressure is not required. Apply just enough pressure so that the couplant fills the gap between the pipe and transducer.)
6. Place the second transducer in between the mounting rails near the dimension derived in the transducer spacing section. Read the dimension on the mounting rail scale. Slide the transducer clamp over the transducer and secure with the thumb screw.

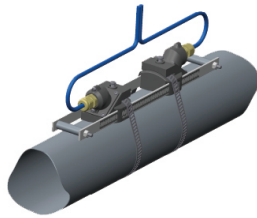

Figure 21: Mounting rail system for DTTR

### Mounting Track Installation for DTTN/DTTH

A convenient transducer mounting track can be used for pipes that have outside diameters between 2...10 inches (50...250 mm) and for DTTN/DTTH transducers. If the pipe is outside of that range, mount the transducers separately.

1. Install the single mounting rail on the side of the pipe with the stainless steel bands provided. Do not mount it on the top or bottom of the pipe. On vertical pipe, orientation is not critical. Check that the track is parallel to the pipe and that all four mounting feet are touching the pipe.
2. Slide the two transducer clamp brackets toward the center mark on the mounting rail.
3. Place a single bead of couplant, approximately 1/2 inch (12 mm) thick, on the flat face of the transducer.  
See *Figure 11* on page 20.
4. Place the first transducer in between the mounting rails near the zero point on the scale. Slide the clamp over the transducer. Adjust the clamp and transducer so the notch in the clamp aligns with the zero on the scale. See *Figure 22*.
5. Secure with the thumb screw. Check that the screw rests in the counter bore on the top of the transducer. (Excessive pressure is not required. Apply just enough pressure so that the couplant fills the gap between the pipe and transducer.)
6. Place the second transducer in between the mounting rails near the dimension derived in the transducer spacing section. Read the dimension on the mounting rail scale. Slide the transducer clamp over the transducer and secure with the thumb screw.

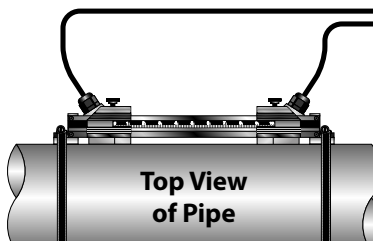

Figure 22: Mounting track installation

# INPUTS/OUTPUTS

## General

The transmitting system is available in two configurations:

- The **Flow-Only model** is equipped with a 4-20 mA output, two open collector outputs, a rate frequency output, and RS485 communications using the Modbus RTU command set.
- The **Energy (BTU) model** has inputs for two 1000 Ohm RTD sensors in place of the rate frequency and alarm outputs. This model allows the measurement of pipe input and output temperatures so energy usage calculations can be performed.

## 4-20 mA Output

The 4-20 mA output interfaces with most recording and logging systems by transmitting an analog current signal that is proportional to system flow rate. The 4-20 mA output is internally powered (current sourcing) and can span negative to positive flow/energy rates.

For AC-powered transmitters, the 4-20 mA output is driven from a 15V DC source located within the transmitter. The source is isolated from earth ground connections within the transmitter. The AC-powered transmitter can accommodate loop loads up to 400 Ohms. DC-powered transmitters use the DC power supply voltage to drive the current loop. The current loop is not isolated from DC ground or power. *Figure 23* shows graphically the allowable loads for various input voltages. The combination of input voltage and loop load must stay within the shaded area of *Figure 23*.

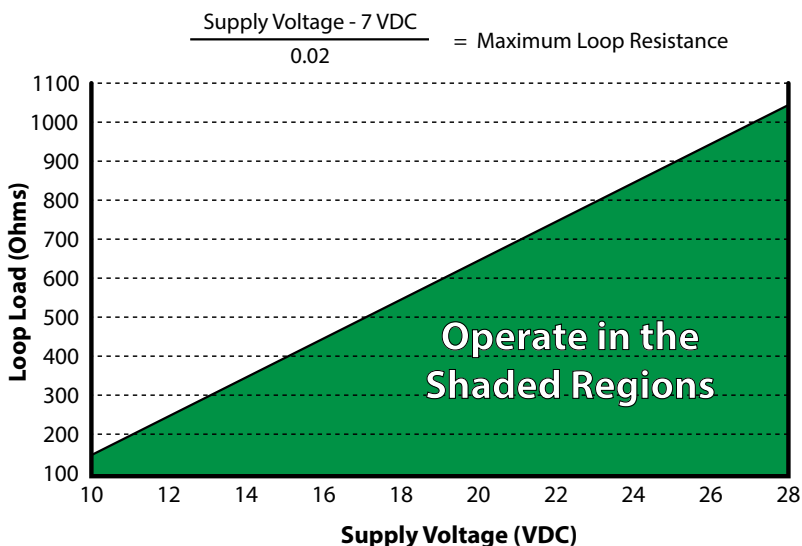

Figure 23: Allowable loop resistance (DC powered transmitters)

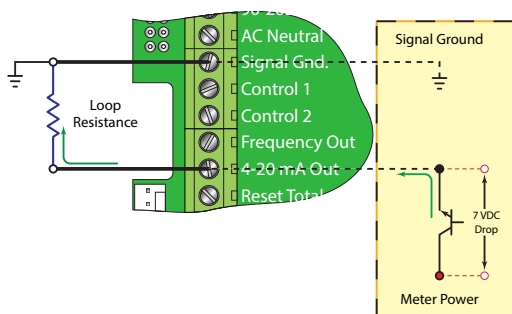

Figure 24: 4-20 mA output

The 4-20 mA output signal is available between the 4-20 mA Out and Signal Gnd terminals as shown in *Figure 24*.

### Reset Total Input

The Reset Total Input can be used with a push-button to reset the flow totals. When the Reset Total Input is connected to signal ground, the total displayed on the meter is reset to zero.

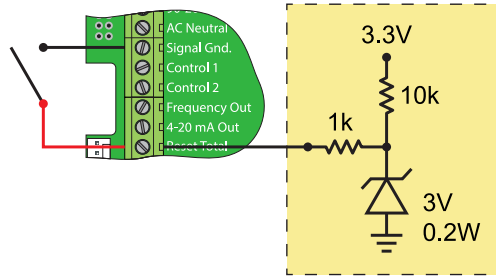

Figure 25: Reset total input

### Control Outputs (Flow-Only Model)

Two independent open collector transistor outputs are included with the Flow-Only model. Each output can be configured for one of the following functions:

- Rate Alarm
- Signal Strength Alarm
- Totalizing/Totalizing Pulse
- Errors
- None

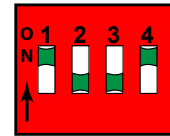

Figure 26: Switch settings

Both control outputs are rated for a maximum of 100 mA and 10...28V DC. A pullup resistor can be added externally or an internal 10k Ohm pullup resistor can be selected using DIP switches on the power supply board.

Switch	S1	S2	S3	S4
On	Control 1 Pullup Resistor IN circuit	Control 2 Pullup Resistor IN circuit	Frequency output Pullup Resistor IN circuit	Square Wave Output
Off	Control 1 Pullup Resistor OUT of circuit	Control 2 Pullup Resistor OUT of circuit	Frequency Output Pullup Resistor OUT of circuit	Simulated Turbine Output

Table 6: Dip switch functions

**NOTE:** All control outputs are disabled when a USB cable is connected.

For the **Rate Alarm** and **Signal Strength Alarm** the on/off values are set using either the keypad or the UltraLink software utility.

Typical control connections are illustrated in Figure 27. Please note that only the Control 1 output is shown. Control 2 is identical except the pullup resistor is governed by SW2.

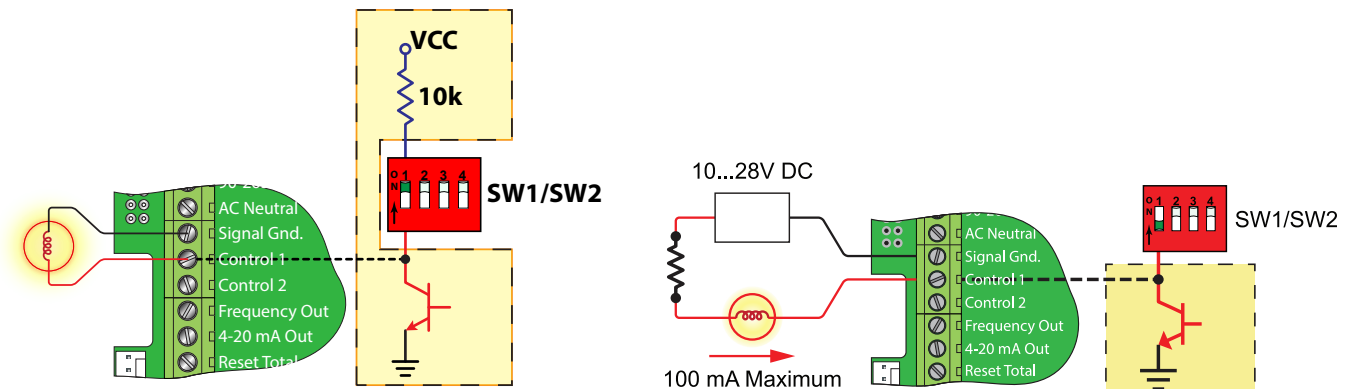

Figure 27: Typical control connections

## Rate Alarm Outputs

The flow rate output permits output changeover at two separate flow rates, allowing operation with an adjustable switch deadband. *Figure 28* illustrates how the setting of the two setpoints influences rate alarm operation.

A single-point flow rate alarm would place the ON setting slightly higher than the OFF setting, allowing a switch deadband to be established. If a deadband is not established, switch chatter (rapid switching) may result if the flow rate is very close to the switch point.

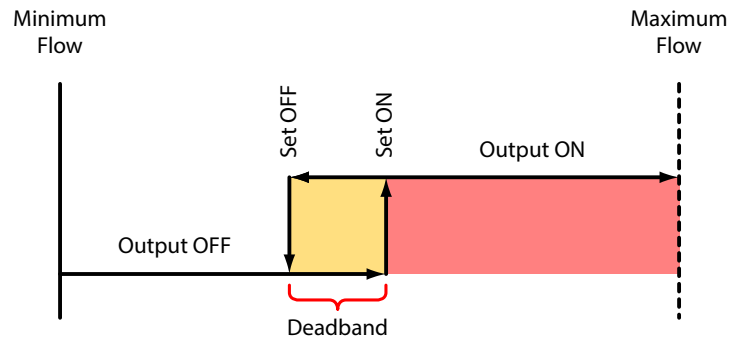

Figure 28: Single point alarm operation

**NOTE:** All control outputs are disabled when a USB cable is connected.

### Signal Strength Alarm

The *SIG STR* alarm will provide an indication that the signal level reported by the transducers has fallen to a point where flow measurements may not be possible. It can also be used to indicate that the pipe has emptied. Like the rate alarm described previously, the signal strength alarm requires that two points be entered, establishing an alarm deadband. A valid switch point exists when the ON value is lower than the OFF value. If a deadband is not established and the signal strength decreases to approximately the value of the switch point, the output may chatter.

### Batch/Totalizer Output (Flow-Only Model)

Totalizer mode configures the output to send a 100 mSec pulse each time the display totalizer increments divided by the *TOT MULT*. The *TOT MULT* value must be a whole, positive numerical value. This output is limited to 1 Hz maximum.

For example, if the totalizer exponent *TOTL E* is set to  $E0 \times 1$  and the totalizer multiplier *TOT MULT* is set to 1, then the output will pulse each time the totalizer increments one count, or each single, whole measurement unit totalized.

If the totalizer exponent *TOTL E* is set to  $E2 \times 100$  and the totalizer multiplier *TOT MULT* is set to 1, then the control output will pulse each time the display totalizer increments or once per 100 measurement units totalized.

If the totalizer exponent *TOTL E* is set to  $E0 \times 1$  and the totalizer multiplier *TOT MULT* is set to 2, the control output will pulse once for every two counts that the totalizer increments.

### Error Alarm Outputs

When a control output is set to *ERROR* mode, the output will activate when any error occurs in the transmitter that has caused the transmitter to stop measuring reliably. See "*Brad Harrison® Connector Option*" on page 95.

## Frequency Output (Flow-Only Model)

The frequency output is an open-collector transistor circuit that outputs a pulse waveform that varies proportionally with flow rate. This type of frequency output is also known as a *Rate Pulse* output. The output spans from 0 Hz, normally at zero flow rate to 1000 Hz at full flow rate (configuration of the *MAX RATE* parameter is described in “Startup” on page 35).

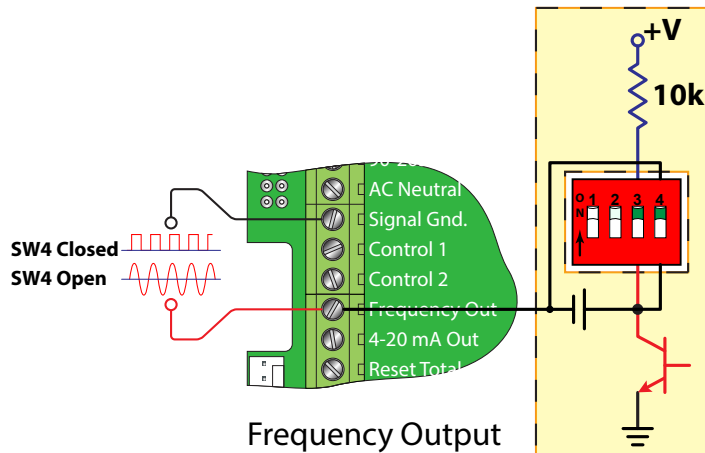

Figure 29: Frequency output switch settings

**NOTE:** When a USB programming cable is connected, the RS485 and frequency outputs are disabled.

The frequency output is proportional to the maximum flow rate entered into the transmitter. The maximum output frequency is 1000 Hz.

If, for example, the *MAX RATE* parameter was set to 400 gpm, then an output frequency of 500 Hz (half of the full scale frequency of 1000 Hz) would represent 200 gpm.

In addition to the control outputs, the frequency output can be used to provide total information by use of a K factor. A K factor simply relates the number of pulses from the frequency output to the number of accumulated pulses that equates to a specific volume.

For this transmitter, the relationship is described by the following equation. The 60,000 relates to measurement units in volume/min. Measurement units in seconds, hours or days would require a different numerator.

$$K \text{ factor} = \frac{60,000}{\text{Full Scale Units}}$$

A practical example would be if the *MAX RATE* for the application were 400 gpm, the K factor (representing the number of pulses accumulated needed to equal one gallon) would be:

$$K \text{ factor} = \frac{60,000}{400 \text{ gpm}} = 150 \text{ Pulses Per Gallon}$$

If the frequency output is to be used as a totalizing output, the transmitter and the receiving instrument must have identical K factor values programmed into them to ensure that accurate readings are being recorded by the receiving instrument. Unlike standard mechanical transmitters such as turbines, gear or nutating disc meters, the K factor can be changed by modifying the *MAX RATE* flow rate value. See “Calculating K Factors” on page 106.



There are two frequency output options available:

- The **Turbine Meter Simulation** option is used when a receiving instrument is capable of interfacing directly with a turbine transmitter's magnetic pickup. The output is a relatively low voltage AC signal whose amplitude swings above and below the signal ground reference. The minimum AC amplitude is approximately 500 mV peak-to-peak. To activate the turbine output circuit, turn **SW4** OFF.

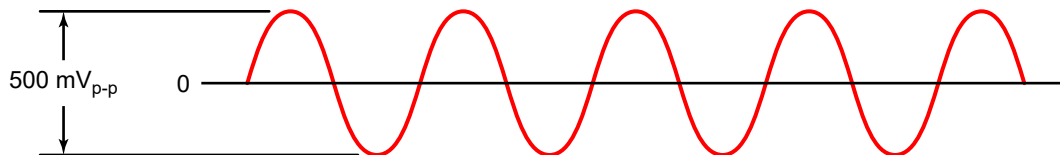

Figure 30: Frequency output waveform (simulated turbine)

- The **Square-Wave Frequency** option is used when a receiving instrument requires that the pulse voltage level be either of a higher potential and/or referenced to DC ground. The output is a square-wave with a peak voltage equaling the instrument supply voltage when the **SW3** is ON. If desired, an external pullup resistor and power source can be used by leaving **SW3** OFF. Set **SW4** to ON for a square-wave output.

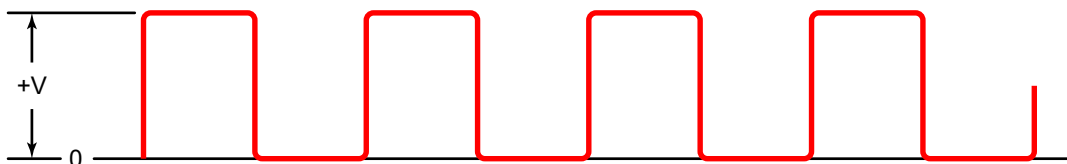

Figure 31: Frequency output waveform (square wave)

## Totalizer Output Option (Energy Model)

Energy models can be ordered with a totalizer pulse output option. This option is installed in the position where the Ethernet option would normally be installed.

### Optional Totalizing Pulse Specifications

Parameter	Specification
Signal	One pulse for each increment of the totalizer's least significant digit
Type	Opto-isolated, open collector transistor
Pulse Width	30 mSec, maximum pulse rate 16 Hz
Voltage	28V DC maximum
Current	100 mA maximum (current sink)
Pullup Resistor	2.8 ... 10 k Ohms

Table 7: Optional energy usage totalizing pulse output

**NOTE:** The totalizer pulse output option and the Ethernet communications output cannot be installed in the same Energy model at the same time.

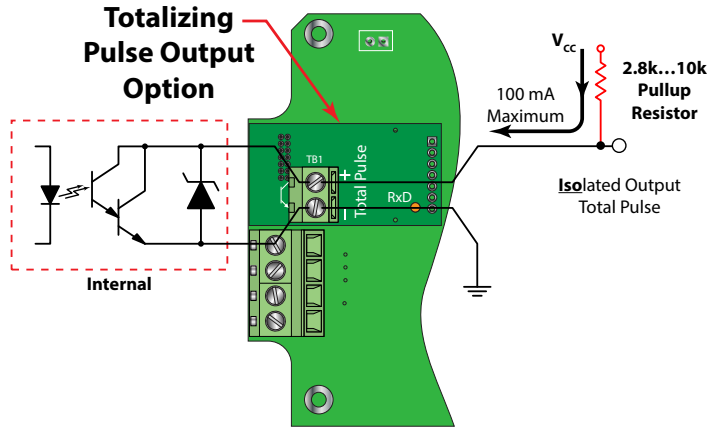

Figure 32: Energy model auxiliary totalizer output option

Wiring and configuration of the Energy model is similar to the totalizing pulse output for the Flow-Only model. This option **must use** an external current limiting resistor.

### RS485 Port

The RS485 feature allows up to 126 transmitters to be placed on a single three-wire cable bus. All transmitters are assigned a unique numeric address that allows all of the transmitters on the cable network to be independently accessed. A Modbus RTU command protocol is used to interrogate the transmitters. See “*Communications Protocols*” on page 66.

Flow rate, total, signal strength and temperature (if so equipped) can be monitored over the digital communications bus. Baud rates up to 9600 and cable lengths to 5000 feet (1500 meters) are supported without repeaters or end-of-line resistors.

To interconnect transmitters, use three-wire shielded cable (like the Belden 9939 or equal). In noisy environments, connect the shield on one end to a good earth-ground connection. Use a USB-to-RS485 converter (like the B&B Electronics P/N 485USBTB-2W) to communicate with a PC running Windows XP, Windows Vista and Windows 7. For computers with RS232C serial ports, use an RS232C-to-RS485 converter (like the B&B Electronics P/N 485SD9TB illustrated in Figure 33), to interconnect the RS485 network to a communication port on a PC. If more than 126 transmitters must be monitored, an additional converter and communication port are required.

**NOTE:** When a USB programming cable is connected, the RS485 and frequency outputs are disabled.

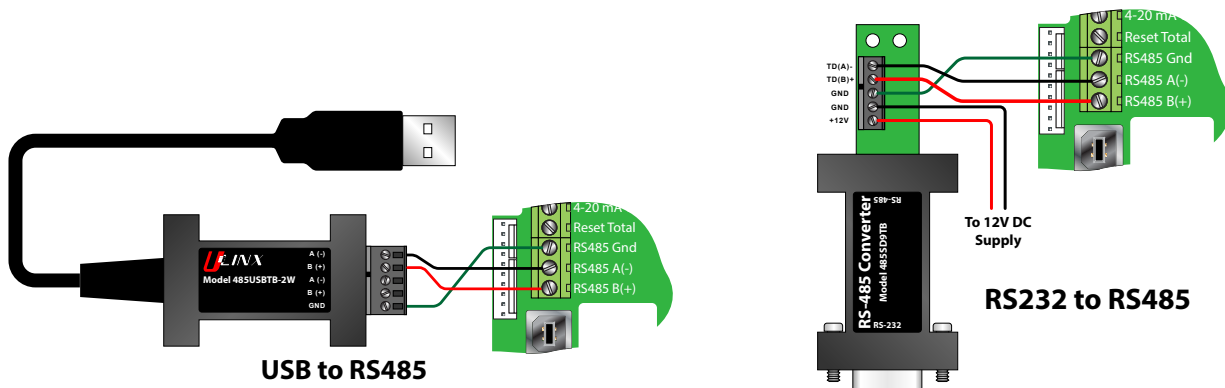

Figure 33: RS485 network connections

## Ethernet Port

The Ethernet port is 10/100 Base T with an RJ connector and supports BACnet IP, Modbus TCP/IP and EtherNet/IP protocols. The Ethernet option must be ordered with the transmitter. For Energy models, the Ethernet option is not available with the Totalizing Pulse option.

See “*Communications Protocols*” on page 66 for information on configuring Ethernet settings.

## USB Programming Port

The USB programming port is a USB 2.0 Type B connector similar to the USB port on many printers. The USB programming port on the transmitter is the cable connection point from a computer with UltraLink software. UltraLink is used for configuring, calibrating and troubleshooting the meter.

See “*Parameter Configuration Using UltraLink Software*” on page 48 for further details.

## HEAT FLOW FOR ENERGY MODEL ONLY

The Energy model allows the integration of two 1000 Ohm, platinum RTDs with the transmitter, effectively providing an instrument for measuring energy consumed in liquid heating and cooling systems. RTDs ordered with the Energy model are factory calibrated and shipped with the transmitter.

The Energy model has multiple heat ranges. Select the range that encompasses the temperature range of your application. The three-wire surface-mount RTDs are attached at the factory to a plug-in connector. Install the RTDs on or in the pipe as recommended, and then plug the RTDs into the RTD connector in the transmitter.

Four ranges of surface-mount RTDs and two lengths of wetted insertion probes are offered. Other cable lengths for surface mount RTDs are available. Contact the manufacturer for additional offerings.

All RTDs are 1000 Ohm platinum, three-wire devices. The surface-mount RTDs are available in standard lengths of 20 feet (6 meters), 50 feet (15 meters) and 100 feet (30 meters) of attached shielded cable.

### Installing Surface-Mounted RTDs

Use surface-mount RTDs on well insulated pipe. Use insertion (wetted) RTDs on pipes that are not insulated.

1. Select areas on the supply and return pipes where the RTDs will be mounted.
2. Remove or peel back the insulation all the way around the pipe in the installation area.
3. Clean an area slightly larger than the RTD down to bare metal on the pipe.
4. Place a small amount of heat sink compound on the pipe in the RTD installation location. See *Figure 35*.
5. Press the RTD firmly into the compound. Fasten the RTD to the pipe with the included stretch tape.
6. Route the RTD cables back to the transmitter and secure the cable so that it will not be pulled on or abraded inadvertently.
7. Replace the insulation on the pipe. Check that the RTDs are not exposed to air currents.

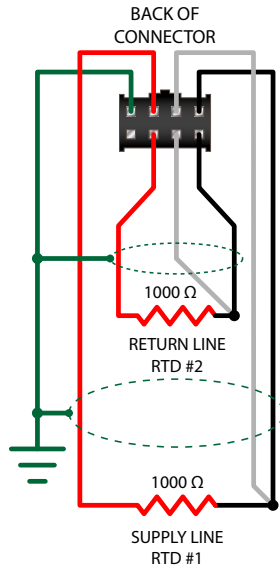

Figure 34: RTD schematic

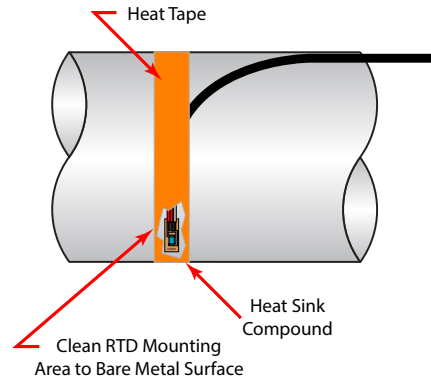

Figure 35: Surface mount RTD installation

## Installing Insertion (Wetted) RTDs

**NOTE:** The hot tap shutoff shown in *Figure 36* is customer-supplied.

Insertion RTDs are typically installed through 1/4 inch (6 mm) compression fittings and isolation ball valves.

1. Insert the RTD sufficiently into the flow stream such that a minimum of 1/4 inch (6 mm) of the probe tip extends into the pipe diameter.

RTDs should be mounted within  $\pm 45$  degrees of the side of a horizontal pipe. On vertical pipes, the orientation is not critical.

2. Route the RTD cables back to the transmitter and secure the cable so it will not be pulled on or abraded inadvertently.

If the cables are not long enough to reach the transmitter, route the cables to an electrical junction box and add cable from that point. Use three-wire shielded cable, such as Belden® 9939 or equal.

**NOTE:** Adding cable adds to the resistance the transmitter reads and may have an effect on absolute accuracy. If cable is added, add the same length to both RTDs to minimize errors due to changes in cable resistance.

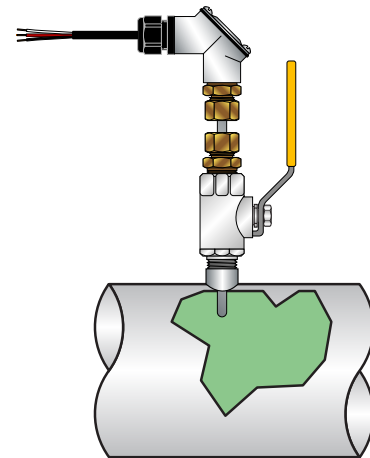

Figure 36: Insertion style RTD installation

## Wiring RTDs to the Transmitter

After the RTDs have been mounted to the pipe:

1. Route the cable back to the transmitter through the middle hole in the enclosure.
2. Insert the RTD connector into the mating connector on the circuit board. Be sure that the alignment tab on the RTD cable is up.

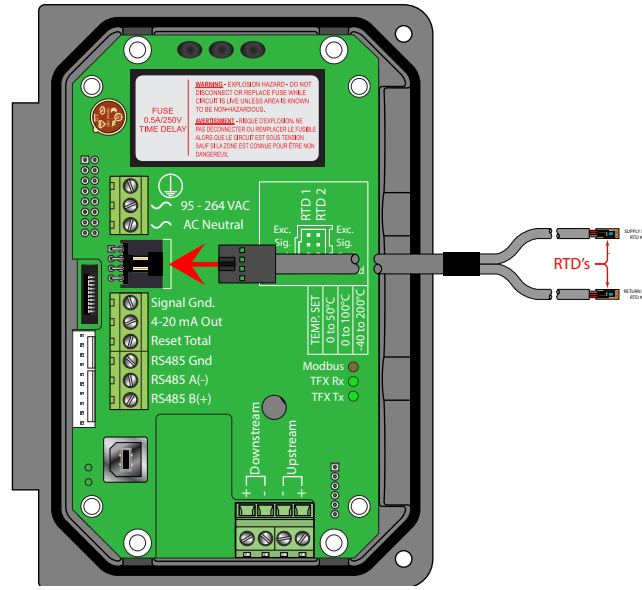

Figure 37: Wiring RTDs to the transmitter

## Replacing RTDs

Complete RTD replacement kits, including the Energy model's plug-in connector and calibration values for the transmitter, are available from the manufacturer.

You can also use other manufacturer's RTDs. The RTDs must be 1000 Ohm, platinum RTDs suitable for a three-wire connection. A connection adapter (part number D005-0350-300) is available to facilitate connection to the Energy model. See *Figure 38*.

**NOTE:** You have to calibrate third-party RTDs according to the directions supplied on the meter being used. See *"In-Field Calibration of RTD Temperature Sensors"* on page 92.

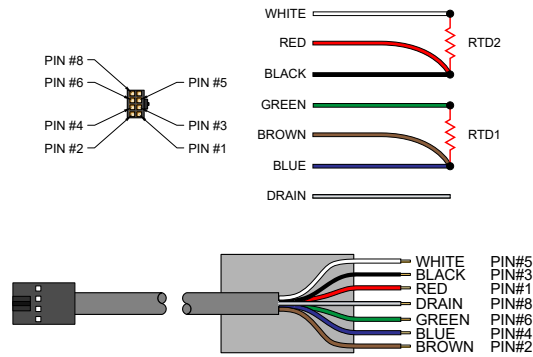

Figure 38: Energy model RTD adapter connections

## PARAMETER CONFIGURATION USING THE KEYPAD

A transmitter with a keypad can be configured through the keypad interface or by using the Windows-compatible UltraLink software utility. When a USB programming cable is connected, the RS485 and frequency outputs are disabled.

Transmitters without a keypad can only be configured using the UltraLink software utility. See “Parameter Configuration Using UltraLink Software” on page 48 for software details. Of the two methods of configuration, the UltraLink software utility provides more advanced features and offers the ability to store and transfer meter configurations between similar transmitters. All entries are saved in non-volatile FLASH memory and are retained indefinitely in the event of a power loss.

The transmitter’s keypad is a four-key tactile feedback interface that lets you view and change configuration parameters used by the operating system.

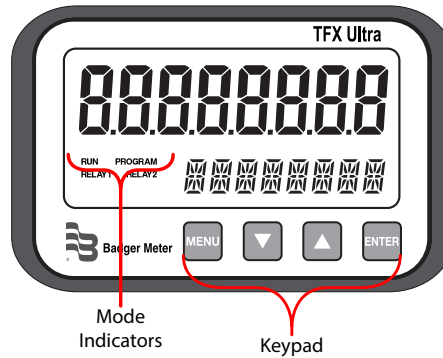

Figure 39: Keypad interface

Key	Function
MENU	Press <b>MENU</b> to toggle between <i>RUN</i> mode and <i>PROGRAM</i> mode. Press <b>MENU</b> while in <i>PROGRAM</i> mode to exit from configuration parameter selection and menus. However, if you changed any configuration parameters, you will be prompted to save the changes before returning to <i>RUN</i> mode. At the prompt, select <b>YES</b> to save the changes.
▲▼	The arrow keys have two functions. Use them to: <ul style="list-style-type: none"> <li>• Scroll through the menus and configuration parameters</li> <li>• Adjust numerical values</li> </ul>
ENTER	Press <b>ENTER</b> from the <i>RUN</i> mode to view the current software version. Press <b>ENTER</b> from the <i>PROGRAM</i> mode to: <ul style="list-style-type: none"> <li>• Access the configuration parameters in the various menus.</li> <li>• Initiate changes in configuration parameters.</li> <li>• Accept configuration parameter changes.</li> </ul>

Table 8: Keypad functions

## STARTUP

The TFX Ultra system requires a full pipe of liquid for a successful startup. Do not attempt to make adjustments or change configurations until a full pipe is verified.

**NOTE:** If you used Dow 732 RTV to couple the transducers to the pipe, make sure the adhesive is fully cured before you try to take readings. Dow 732 RTV takes 24 hours to cure satisfactorily.

1. Verify that all wiring is properly connected and routed, as described in *“Transducer Installation” on page 15.*
2. Verify that the transducers are properly mounted, as described in *“Transducer Installation” on page 15.*
3. Apply power to the transmitter. The transmitter display will briefly show a software version number and then all of the segments will illuminate in succession.
4. Verify that the pipe is full of liquid.
5. Go to *SER MENU > SIG STR* and confirm that the signal strength is 5...98. If the signal strength is lower than five, check the transducer mounting methods and liquid/pipe characteristics you entered. If what you entered is correct, you need to reconfigure the installation to increase the signal strength. For example, change a W-Mount transducer installation to a V-Mount installation. Or change a V-Mount installation to a Z-Mount installation.

**NOTE:** Mounting configuration changes apply only to DTTR, DTTN, DTTL and DTTH transducer sets.

6. Go to *SER MENU > SSPD FPS* and *SSPD MPS* and confirm that the actual measured liquid sound speed is within two percent of the value entered as *FLUID SS* in the *BSC MENU*. The pipe must be full of liquid in order to make this measurement.

Once the transmitter is operating properly, see *“Parameter Configuration Using the Keypad” on page 34* for additional programming features.

## CONFIGURATION

### Menu Structure

The transmitter's firmware has a hierarchical menu structure. See *“Menu Maps” on page 64* for a visual path to the configuration parameters.

The seven menus used in the transmitter firmware are as follows:

Menu	Meaning	Function
<i>BSC MENU</i>	<b>BASIC</b>	Contains all of the configuration parameters necessary to initially program the transmitter to measure flow.
<i>CH1 MENU</i>	<b>CHANNEL 1</b>	Configures the 4-20 mA output. Applies to both the Flow-Only and Energy models.
<i>CH2 MENU</i>	<b>CHANNEL 2</b>	Configures the type and operating parameters for channel 2 output options. Channel 2 parameters are specific to the model of transmitter used.
<i>SEN MENU</i>	<b>SENSOR</b>	Used to select the transducer type such as DTTN or DTTS.
<i>SEC MENU</i>	<b>SECURITY</b>	Used to reset totalizers, return filtering to factory settings, and revise security level of a password.
<i>SER MENU</i>	<b>SERVICE</b>	Contains system settings that are used for advanced configuration and zeroing the transmitter on the pipe.
<i>DSP MENU</i>	<b>DISPLAY</b>	Used to configure transmitter display functions.

The following pages define the configuration parameters located in each of the menus.

## Basic Menu (BSC)

The basic menu contains all of the configuration parameters necessary to make the transmitter operational.

Parameter	Meaning	Options	Description																																																
UNITS	Measurement standard	ENGLISH (Inches) METRIC (Millimeters)	The English/metric selection will also configure the transmitter to display sound speeds in pipe materials and liquids as either feet per second (fps) or meters per second (mps), respectively. <b>IMPORTANT:</b> If the UNITS entry has been changed from ENGLISH to METRIC or from METRIC to ENGLISH, the entry must be saved and the instrument reset (power cycled or System Reset SYS RSET entered) in order for the transmitter to initiate the change in operating units. Failure to save and reset the instrument will lead to improper transducer spacing calculations and an instrument that may not measure properly.																																																
ADDRESS	Modbus or BACnet address	1...126	This address is for the EIA-485 port only. Ethernet addresses are set via the integrated HTML application in the Ethernet Port. For transmitters ordered with a Modbus RTU option, enter a value 1...126. For transmitters ordered with a BACnet MS/TP option, enter a value 0...127. Each transmitter connected on the network must have a unique address number assigned.																																																
BAUD	Baud rate of RS485	9600 14400 19200 38400 56000 57600 76800	—																																																
BACNET ID	BACnet device ID value	0...4194303	Applies to BACnet networks only.																																																
XDCR MNT	Transducer mounting method	V W Z	Selects the mounting orientation for the transducers based on pipe and liquid characteristics. See <i>"Transducer Installation"</i> on page 15 .																																																
XDCR HZ	Transducer transmission frequency	500 kHz 1 MHz 2 MHz	Transducer transmission frequencies are specific to the type of transducer and the size of pipe. In general the DTTL 500 kHz transducers are used for pipes greater than 24 inches (600 mm). DTTR, DTTN and DTTH 1 MHz transducers, are for intermediate sized pipes between 2 inches (50 mm) and 24 inches (600 mm). The DTTs and DTTC, 2 MHz transducers, are for pipe sizes between 1/2 inch (13 mm) and 2 inches (50 mm)																																																
FLO DIR	Transducer flow direction	FORWARD REVERSE	Allows the change of the direction the transmitter assumes is forward. When mounting transmitters with integral transducers, this feature allows upstream and downstream transducers to be "electronically" reversed making upside down mounting of the display unnecessary.																																																
PIPE OD	Pipe outside diameter	ENGLISH (Inches) METRIC (Millimeters)	Enter the pipe outside diameter in inches if <i>ENGLISH</i> was selected as <i>UNITS</i> ; in millimeters if <i>METRIC</i> was selected. Charts listing popular pipe sizes have been included in the Appendix of this manual. Correct entries for pipe O.D. and pipe wall thickness are critical to obtaining accurate flow measurement readings.																																																
PIPE WT	Pipe wall thickness	ENGLISH (Inches) METRIC (Millimeters)	Enter the pipe wall thickness in inches if <i>ENGLISH</i> was selected as <i>UNITS</i> ; in millimeters if <i>METRIC</i> was selected. See <i>"North American Pipe Schedules"</i> on page 110 for charts listing popular pipe sizes. Correct entries for pipe O.D. and pipe wall thickness are critical to obtaining accurate flow measurement readings.																																																
PIPE MAT	Pipe material	<p>Select a material. This list is provided as an example. Additional pipe materials are added periodically. Select the appropriate pipe material from the list or select <i>OTHER</i> if the material is not listed.</p> <table border="1"> <tbody> <tr> <td>Acrylic</td> <td>ACRYLIC</td> <td>Glass Pyrex</td> <td>PYREX</td> <td>St Steel 304/316</td> <td>SS 316</td> </tr> <tr> <td>Aluminum</td> <td>ALUMINUM</td> <td>Nylon</td> <td>NYLON</td> <td>St Steel 410</td> <td>SS 410</td> </tr> <tr> <td>Brass (Naval)</td> <td>BRASS</td> <td>HD Polyethylene</td> <td>HDPE</td> <td>St Steel 430</td> <td>SS 430</td> </tr> <tr> <td>Carbon Steel</td> <td>CARB ST</td> <td>LD Polyethylene</td> <td>LDPE</td> <td>PFA</td> <td>PFA</td> </tr> <tr> <td>Cast Iron</td> <td>CAST IRN</td> <td>Polypropylene</td> <td>POLYPRO</td> <td>Titanium</td> <td>TITANIUM</td> </tr> <tr> <td>Copper</td> <td>COPPER</td> <td>PVC CPVC</td> <td>PVC/CPVC</td> <td>Asbestos</td> <td>ASBESTOS</td> </tr> <tr> <td>Ductile Iron</td> <td>DCTL IRN</td> <td>PVDF</td> <td>PVDF</td> <td>Other</td> <td>OTHER</td> </tr> <tr> <td>Fiberglass-Epoxy</td> <td>FBRGLASS</td> <td>St Steel 302/303</td> <td>SS 303</td> <td></td> <td></td> </tr> </tbody> </table>		Acrylic	ACRYLIC	Glass Pyrex	PYREX	St Steel 304/316	SS 316	Aluminum	ALUMINUM	Nylon	NYLON	St Steel 410	SS 410	Brass (Naval)	BRASS	HD Polyethylene	HDPE	St Steel 430	SS 430	Carbon Steel	CARB ST	LD Polyethylene	LDPE	PFA	PFA	Cast Iron	CAST IRN	Polypropylene	POLYPRO	Titanium	TITANIUM	Copper	COPPER	PVC CPVC	PVC/CPVC	Asbestos	ASBESTOS	Ductile Iron	DCTL IRN	PVDF	PVDF	Other	OTHER	Fiberglass-Epoxy	FBRGLASS	St Steel 302/303	SS 303		
Acrylic	ACRYLIC	Glass Pyrex	PYREX	St Steel 304/316	SS 316																																														
Aluminum	ALUMINUM	Nylon	NYLON	St Steel 410	SS 410																																														
Brass (Naval)	BRASS	HD Polyethylene	HDPE	St Steel 430	SS 430																																														
Carbon Steel	CARB ST	LD Polyethylene	LDPE	PFA	PFA																																														
Cast Iron	CAST IRN	Polypropylene	POLYPRO	Titanium	TITANIUM																																														
Copper	COPPER	PVC CPVC	PVC/CPVC	Asbestos	ASBESTOS																																														
Ductile Iron	DCTL IRN	PVDF	PVDF	Other	OTHER																																														
Fiberglass-Epoxy	FBRGLASS	St Steel 302/303	SS 303																																																



**Basic Menu (BSC) continued**

Parameter	Meaning	Options	Description																																										
PIPE SS	Pipe sound speed	ENGLISH (fps) METRIC (mps)	Specifies the speed of sound value, shear or transverse wave, for the pipe wall. If the <i>UNITS</i> value was set to <i>ENGLISH</i> , the entry is in fps (feet per second). <i>METRIC</i> entries are made in mps (meters per second).  If a pipe material was chosen from the <i>PIPE MAT</i> list, a nominal value for speed of sound in that material will be automatically loaded. If the actual sound speed is known for the application piping system and that value varies from the automatically loaded value, the value can be revised.  If <i>OTHER</i> was chosen as <i>PIPE MAT</i> , then a <i>PIPE SS</i> must also be entered.																																										
PIPE R	Pipe material relative roughness	(Enter a numeric value)	The transmitter provides flow profile compensation in its flow measurement calculation. The ratio of average surface imperfection as it relates to the pipe internal diameter is used in this compensation algorithm and is found by using the following formula:  $\text{Pipe R} = \frac{\text{Linear RMS Measurement of the Pipes Internal Wall Surface}}{\text{Inside Diameter of the Pipe}}$  If a pipe material was chosen from the <i>PIPE MAT</i> list, a nominal value for relative roughness in that material will be automatically loaded. If the actual roughness is known for the application piping system and that value varies from the automatically loaded value, the value can be revised.																																										
LINER T	Pipe liner thickness	ENGLISH (Inches) METRIC (Millimeters)	If the pipe has a liner, enter the pipe liner thickness. Enter this value in inches if <i>ENGLISH</i> was selected as <i>UNITS</i> ; in millimeters if <i>METRIC</i> was selected.																																										
LINER MA	Pipe liner material	<p>Select a liner material. This list is provided as an example. Additional materials are added periodically. Select the appropriate material from the list or select <i>OTHER</i> if the liner material is not listed.</p> <table border="1"> <tr> <td>Tar Epoxy</td> <td><i>TAR EPXY</i></td> <td>HD Polyethylene</td> <td><i>HDPE</i></td> </tr> <tr> <td>Rubber</td> <td><i>RUBBER</i></td> <td>LD Polyethylene</td> <td><i>LDPE</i></td> </tr> <tr> <td>Mortar</td> <td><i>MORTAR</i></td> <td>Teflon (PFA)</td> <td><i>TEFLON</i></td> </tr> <tr> <td>Polypropylene</td> <td><i>POLYPRO</i></td> <td>Ebonite</td> <td><i>EBONITE</i></td> </tr> <tr> <td>Polystyrene</td> <td><i>POLYSTY</i></td> <td>Other</td> <td><i>OTHER</i></td> </tr> </table>		Tar Epoxy	<i>TAR EPXY</i>	HD Polyethylene	<i>HDPE</i>	Rubber	<i>RUBBER</i>	LD Polyethylene	<i>LDPE</i>	Mortar	<i>MORTAR</i>	Teflon (PFA)	<i>TEFLON</i>	Polypropylene	<i>POLYPRO</i>	Ebonite	<i>EBONITE</i>	Polystyrene	<i>POLYSTY</i>	Other	<i>OTHER</i>																						
Tar Epoxy	<i>TAR EPXY</i>	HD Polyethylene	<i>HDPE</i>																																										
Rubber	<i>RUBBER</i>	LD Polyethylene	<i>LDPE</i>																																										
Mortar	<i>MORTAR</i>	Teflon (PFA)	<i>TEFLON</i>																																										
Polypropylene	<i>POLYPRO</i>	Ebonite	<i>EBONITE</i>																																										
Polystyrene	<i>POLYSTY</i>	Other	<i>OTHER</i>																																										
LINER SS	Speed of sound in the liner	ENGLISH (fps) METRIC (mps)	Allows adjustments to be made to the speed of sound value, shear or transverse wave, for the pipe wall. If the <i>UNITS</i> value was set to <i>ENGLISH</i> , the entry is in fps (feet per second). <i>METRIC</i> entries are made in mps (meters per second).  If a liner was chosen from the <i>LINER MA</i> list, a nominal value for speed of sound in that media will be automatically loaded. If the actual sound speed rate is known for the pipe liner and that value varies from the automatically loaded value, the value can be revised.																																										
LINER R	Liner material relative roughness	(Enter a numeric value)	The transmitter provides flow profile compensation in its flow measurement calculation. The ratio of average surface imperfection as it relates to the pipe internal diameter is used in this compensation and is found by using the following formula:  $\text{Liner R} = \frac{\text{Linear RMS Measurement of the Liner's Internal Wall Surface}}{\text{Inside Diameter of the Liner}}$  If a liner material was chosen from the <i>LINER MA</i> list, a nominal value for relative roughness in that material will be automatically loaded. If the actual roughness is known for the application liner and that value varies from the automatically loaded value, the value can be revised.																																										
FL TYPE	Fluid/media type	<p>Select a fluid type. This list is provided as an example. Additional liquids are added periodically. Select the appropriate liquid from the list or select <i>OTHER</i> if the liquid is not listed.</p> <table border="1"> <tr> <td>Water Tap</td> <td><i>WATER</i></td> <td>Ethanol</td> <td><i>ETHANOL</i></td> <td>Oil Hydraulic, Petro-based</td> <td><i>HYD OIL</i></td> </tr> <tr> <td>Sewage</td> <td><i>SEWAGE</i></td> <td>Ethylene Glycol</td> <td><i>ETH-GLYC</i></td> <td>Oil Lubricating</td> <td><i>LUBE OIL</i></td> </tr> <tr> <td>Acetone</td> <td><i>ACETONE</i></td> <td>Gasoline</td> <td><i>GASOLINE</i></td> <td>Oil Motor, SAE 20/30</td> <td><i>MTR OIL</i></td> </tr> <tr> <td>Alcohol</td> <td><i>ALCOHOL</i></td> <td>Glycerin</td> <td><i>GLYCERIN</i></td> <td>Water Distilled</td> <td><i>WATR-DST</i></td> </tr> <tr> <td>Ammonia</td> <td><i>AMMONIA</i></td> <td>Isopropyl Alcohol</td> <td><i>ISO-ALC</i></td> <td>Water Sea</td> <td><i>WATR-SEA</i></td> </tr> <tr> <td>Benzene</td> <td><i>BENZENE</i></td> <td>Kerosene</td> <td><i>KEROSENE</i></td> <td>Other</td> <td><i>OTHER</i></td> </tr> <tr> <td>Brine</td> <td><i>BRINE</i></td> <td>Methanol</td> <td><i>METHANOL</i></td> <td></td> <td></td> </tr> </table>		Water Tap	<i>WATER</i>	Ethanol	<i>ETHANOL</i>	Oil Hydraulic, Petro-based	<i>HYD OIL</i>	Sewage	<i>SEWAGE</i>	Ethylene Glycol	<i>ETH-GLYC</i>	Oil Lubricating	<i>LUBE OIL</i>	Acetone	<i>ACETONE</i>	Gasoline	<i>GASOLINE</i>	Oil Motor, SAE 20/30	<i>MTR OIL</i>	Alcohol	<i>ALCOHOL</i>	Glycerin	<i>GLYCERIN</i>	Water Distilled	<i>WATR-DST</i>	Ammonia	<i>AMMONIA</i>	Isopropyl Alcohol	<i>ISO-ALC</i>	Water Sea	<i>WATR-SEA</i>	Benzene	<i>BENZENE</i>	Kerosene	<i>KEROSENE</i>	Other	<i>OTHER</i>	Brine	<i>BRINE</i>	Methanol	<i>METHANOL</i>		
Water Tap	<i>WATER</i>	Ethanol	<i>ETHANOL</i>	Oil Hydraulic, Petro-based	<i>HYD OIL</i>																																								
Sewage	<i>SEWAGE</i>	Ethylene Glycol	<i>ETH-GLYC</i>	Oil Lubricating	<i>LUBE OIL</i>																																								
Acetone	<i>ACETONE</i>	Gasoline	<i>GASOLINE</i>	Oil Motor, SAE 20/30	<i>MTR OIL</i>																																								
Alcohol	<i>ALCOHOL</i>	Glycerin	<i>GLYCERIN</i>	Water Distilled	<i>WATR-DST</i>																																								
Ammonia	<i>AMMONIA</i>	Isopropyl Alcohol	<i>ISO-ALC</i>	Water Sea	<i>WATR-SEA</i>																																								
Benzene	<i>BENZENE</i>	Kerosene	<i>KEROSENE</i>	Other	<i>OTHER</i>																																								
Brine	<i>BRINE</i>	Methanol	<i>METHANOL</i>																																										

**Basic Menu (BSC) continued**

Parameter	Meaning	Options	Description
FLUID SS	Speed of sound in the fluid	ENGLISH (fps) METRIC (mps)	<p>Allows adjustments to be made to the speed of sound entry for the liquid. If the <i>UNITS</i> value was set to <i>ENGLISH</i>, the entry is in fps (feet per second). <i>METRIC</i> entries are made in mps (meters per second).</p> <p>If a fluid was chosen from the <i>FL TYPE</i> list, a nominal value for speed of sound in that media will be automatically loaded. If the actual sound speed is known for the application fluid and that value varies from the automatically loaded value, the value can be revised.</p> <p>If <i>OTHER</i> was chosen as <i>FL TYPE</i>, a <i>FLUID SS</i> will need to be entered. A list of alternate fluids and their associated sound speeds is located in the Appendix located at the back of this manual.</p> <p>Fluid sound speed may also be found using the <i>Target DBg Data</i> screen available in the UltraLink software utility. See "<i>Target Dbg Data Screen Definitions</i>" on page 63.</p>
FLUID VI	Absolute viscosity of the fluid	(Enter a numeric value in centipoise)	<p>Allows adjustments to be made to the absolute viscosity of the liquid in centipoise.</p> <p>Ultrasonic transmitters use pipe size, viscosity and specific gravity to calculate Reynolds numbers. Since the Reynolds number influences flow profile, the transmitter has to compensate for the relatively high velocities at the pipe center during transitional or laminar flow conditions. The entry of <i>FLUID VI</i> is used in the calculation of Reynolds and the resultant compensation values.</p> <p>If a fluid was chosen from the <i>FL TYPE</i> list, a nominal value for viscosity in that media will be automatically loaded. If the actual viscosity is known for the application fluid and that value varies from the automatically loaded value, the value can be revised.</p> <p>If <i>OTHER</i> was chosen as <i>FL TYPE</i>, then a <i>FLUID VI</i> must also be entered. See "<i>Fluid Properties</i>" on page 115 for a list of alternate fluids and their associated viscosities.</p>
SP GRAVITY	Fluid specific gravity	(Enter a numeric value)	<p>Allows adjustments to be made to the specific gravity (density relative to water) of the liquid.</p> <p>As stated previously in the <i>FLUID VI</i> section, specific gravity is used in the Reynolds correction algorithm. It is also used if mass flow measurement units are selected for rate or total.</p> <p>If a fluid was chosen from the <i>FL TYPE</i> list, a nominal value for specific gravity in that media will be automatically loaded. If the actual specific gravity is known for the application fluid and that value varies from the automatically loaded value, the value can be revised.</p> <p>If <i>OTHER</i> was chosen as <i>FL TYPE</i>, a <i>SP GRVITY</i> may need to be entered if mass flows are to be calculated. See "<i>Specifications</i>" on page 108 for list of alternate fluids and their specific gravities.</p>

Basic Menu (BSC) continued

Parameter	Meaning	Options	Description																																																																																																																																																					
SP HEAT	Fluid specific heat capacity	BTU/lb	<p>Allows adjustments to be made to the specific heat capacity of the liquid. If a fluid was chosen from the <i>FL TYPE</i> list, a default specific heat will be automatically loaded. This default value is displayed as <i>SP HEAT</i> in the <i>BSC MENU</i>. If the actual specific heat of the liquid is known or it differs from the default value, the value can be revised. See <i>Table 6</i>, <i>Table 7</i> and <i>Table 8</i> for specific values. Enter a value that is the mean of both pipes.</p> <table border="1"> <thead> <tr> <th colspan="3">Specific Heat Capacity for Water</th> </tr> <tr> <th colspan="2">Temperature</th> <th rowspan="2">Specific Heat BTU/lb ° F</th> </tr> <tr> <th>° F</th> <th>° C</th> </tr> </thead> <tbody> <tr> <td>32...212</td> <td>0...100</td> <td>1.00</td> </tr> <tr> <td>250</td> <td>121</td> <td>1.02</td> </tr> <tr> <td>300</td> <td>149</td> <td>1.03</td> </tr> <tr> <td>350</td> <td>177</td> <td>1.05</td> </tr> </tbody> </table> <table border="1"> <thead> <tr> <th colspan="4">Specific Heat Capacity Values for Common Fluids</th> </tr> <tr> <th rowspan="2">Fluid</th> <th colspan="2">Temperature</th> <th rowspan="2">Specific Heat BTU/lb ° F</th> </tr> <tr> <th>° F</th> <th>° C</th> </tr> </thead> <tbody> <tr> <td>Ethanol</td> <td>32</td> <td>0</td> <td>0.65</td> </tr> <tr> <td>Methanol</td> <td>54</td> <td>12</td> <td>0.60</td> </tr> <tr> <td>Brine</td> <td>32</td> <td>0</td> <td>0.71</td> </tr> <tr> <td>Brine</td> <td>60</td> <td>15</td> <td>0.72</td> </tr> <tr> <td>Sea Water</td> <td>63</td> <td>17</td> <td>0.94</td> </tr> </tbody> </table> <table border="1"> <thead> <tr> <th colspan="9">Specific Heat Capacity BTU/lb °F</th> </tr> <tr> <th colspan="2">Temperature</th> <th colspan="7">Ethylene Glycol Solution (% by Volume)</th> </tr> <tr> <th>° F</th> <th>° C</th> <th>25</th> <th>30</th> <th>40</th> <th>50</th> <th>60</th> <th>65</th> <th>100</th> </tr> </thead> <tbody> <tr> <td>-40</td> <td>-40</td> <td>n/a</td> <td>n/a</td> <td>n/a</td> <td>n/a</td> <td>0.68</td> <td>0.70</td> <td>n/a</td> </tr> <tr> <td>0</td> <td>-17.8</td> <td>n/a</td> <td>n/a</td> <td>0.83</td> <td>0.78</td> <td>0.72</td> <td>0.70</td> <td>0.54</td> </tr> <tr> <td>40</td> <td>4.4</td> <td>0.91</td> <td>0.89</td> <td>0.845</td> <td>0.80</td> <td>0.75</td> <td>0.72</td> <td>0.56</td> </tr> <tr> <td>80</td> <td>26.7</td> <td>0.92</td> <td>0.90</td> <td>0.86</td> <td>0.82</td> <td>0.77</td> <td>0.74</td> <td>0.59</td> </tr> <tr> <td>120</td> <td>84.9</td> <td>0.93</td> <td>0.92</td> <td>0.88</td> <td>0.83</td> <td>0.79</td> <td>0.77</td> <td>0.61</td> </tr> <tr> <td>160</td> <td>71.1</td> <td>0.94</td> <td>0.93</td> <td>0.89</td> <td>0.85</td> <td>0.81</td> <td>0.79</td> <td>0.64</td> </tr> <tr> <td>200</td> <td>93.3</td> <td>0.95</td> <td>0.94</td> <td>0.91</td> <td>0.87</td> <td>0.83</td> <td>0.81</td> <td>0.66</td> </tr> <tr> <td>240</td> <td>115.6</td> <td>n/a</td> <td>n/a</td> <td>n/a</td> <td>n/a</td> <td>n/a</td> <td>0.83</td> <td>0.69</td> </tr> </tbody> </table>	Specific Heat Capacity for Water			Temperature		Specific Heat BTU/lb ° F	° F	° C	32...212	0...100	1.00	250	121	1.02	300	149	1.03	350	177	1.05	Specific Heat Capacity Values for Common Fluids				Fluid	Temperature		Specific Heat BTU/lb ° F	° F	° C	Ethanol	32	0	0.65	Methanol	54	12	0.60	Brine	32	0	0.71	Brine	60	15	0.72	Sea Water	63	17	0.94	Specific Heat Capacity BTU/lb °F									Temperature		Ethylene Glycol Solution (% by Volume)							° F	° C	25	30	40	50	60	65	100	-40	-40	n/a	n/a	n/a	n/a	0.68	0.70	n/a	0	-17.8	n/a	n/a	0.83	0.78	0.72	0.70	0.54	40	4.4	0.91	0.89	0.845	0.80	0.75	0.72	0.56	80	26.7	0.92	0.90	0.86	0.82	0.77	0.74	0.59	120	84.9	0.93	0.92	0.88	0.83	0.79	0.77	0.61	160	71.1	0.94	0.93	0.89	0.85	0.81	0.79	0.64	200	93.3	0.95	0.94	0.91	0.87	0.83	0.81	0.66	240	115.6	n/a	n/a	n/a	n/a	n/a	0.83	0.69
Specific Heat Capacity for Water																																																																																																																																																								
Temperature		Specific Heat BTU/lb ° F																																																																																																																																																						
° F	° C																																																																																																																																																							
32...212	0...100	1.00																																																																																																																																																						
250	121	1.02																																																																																																																																																						
300	149	1.03																																																																																																																																																						
350	177	1.05																																																																																																																																																						
Specific Heat Capacity Values for Common Fluids																																																																																																																																																								
Fluid	Temperature		Specific Heat BTU/lb ° F																																																																																																																																																					
	° F	° C																																																																																																																																																						
Ethanol	32	0	0.65																																																																																																																																																					
Methanol	54	12	0.60																																																																																																																																																					
Brine	32	0	0.71																																																																																																																																																					
Brine	60	15	0.72																																																																																																																																																					
Sea Water	63	17	0.94																																																																																																																																																					
Specific Heat Capacity BTU/lb °F																																																																																																																																																								
Temperature		Ethylene Glycol Solution (% by Volume)																																																																																																																																																						
° F	° C	25	30	40	50	60	65	100																																																																																																																																																
-40	-40	n/a	n/a	n/a	n/a	0.68	0.70	n/a																																																																																																																																																
0	-17.8	n/a	n/a	0.83	0.78	0.72	0.70	0.54																																																																																																																																																
40	4.4	0.91	0.89	0.845	0.80	0.75	0.72	0.56																																																																																																																																																
80	26.7	0.92	0.90	0.86	0.82	0.77	0.74	0.59																																																																																																																																																
120	84.9	0.93	0.92	0.88	0.83	0.79	0.77	0.61																																																																																																																																																
160	71.1	0.94	0.93	0.89	0.85	0.81	0.79	0.64																																																																																																																																																
200	93.3	0.95	0.94	0.91	0.87	0.83	0.81	0.66																																																																																																																																																
240	115.6	n/a	n/a	n/a	n/a	n/a	0.83	0.69																																																																																																																																																
XDC SPAC	Transducer spacing calculation	ENGLISH (Inches) METRIC (Millimeters)	<p><b>NOTE:</b> This value is calculated by the firmware after all pipe parameters have been entered. The spacing value only pertains to DTTR,DTTN, DTTL and DTTH transducer sets.</p> <p>This value represents the one-dimensional linear measurement between the transducers (the upstream/downstream measurement that runs parallel to the pipe). This value is in inches if <i>ENGLISH</i> was selected as <i>UNITS</i>; in millimeters if <i>METRIC</i> was selected. This measurement is taken between the lines which are scribed into the side of the transducer blocks.</p> <p>If the transducers are being mounted using the transducer track assembly, a measuring scale is etched into the track. Place one transducer at 0 and the other at the appropriate measurement.</p>																																																																																																																																																					
RATE UNT	Engineering units for flow rate	<p>Select an engineering unit for flow rate measurements.</p> <table border="1"> <thead> <tr> <th>US Gallons</th> <th>US Gallons</th> <th>Pounds</th> <th>LB</th> </tr> </thead> <tbody> <tr> <td>Liters</td> <td>Liters</td> <td>Kilograms</td> <td>KG</td> </tr> <tr> <td>Millions of US Gallons</td> <td>MGal</td> <td>British Thermal Units</td> <td>BTU</td> </tr> <tr> <td>Cubic Feet</td> <td>Cubic Ft</td> <td>Thousands of BTUs</td> <td>MBTU</td> </tr> <tr> <td>Cubic Meters</td> <td>Cubic Me</td> <td>Millions of BTUs</td> <td>MMBTU</td> </tr> <tr> <td>Acre Feet</td> <td>Acre Ft</td> <td>1 Ton/HR [12000 BTU]</td> <td>TONHR</td> </tr> <tr> <td>Oil Barrels</td> <td>Oil Barr [42 US Gallons]</td> <td>Kilojoule</td> <td>kJ</td> </tr> <tr> <td>Liquid Barrels</td> <td>Liq Barr [31.5 US Gallons]</td> <td>Kilowatt</td> <td>kWH</td> </tr> <tr> <td>Feet</td> <td>Feet</td> <td>Megawatt</td> <td>MWH</td> </tr> <tr> <td>Meters</td> <td>Meters</td> <td></td> <td></td> </tr> </tbody> </table>		US Gallons	US Gallons	Pounds	LB	Liters	Liters	Kilograms	KG	Millions of US Gallons	MGal	British Thermal Units	BTU	Cubic Feet	Cubic Ft	Thousands of BTUs	MBTU	Cubic Meters	Cubic Me	Millions of BTUs	MMBTU	Acre Feet	Acre Ft	1 Ton/HR [12000 BTU]	TONHR	Oil Barrels	Oil Barr [42 US Gallons]	Kilojoule	kJ	Liquid Barrels	Liq Barr [31.5 US Gallons]	Kilowatt	kWH	Feet	Feet	Megawatt	MWH	Meters	Meters																																																																																																															
US Gallons	US Gallons	Pounds	LB																																																																																																																																																					
Liters	Liters	Kilograms	KG																																																																																																																																																					
Millions of US Gallons	MGal	British Thermal Units	BTU																																																																																																																																																					
Cubic Feet	Cubic Ft	Thousands of BTUs	MBTU																																																																																																																																																					
Cubic Meters	Cubic Me	Millions of BTUs	MMBTU																																																																																																																																																					
Acre Feet	Acre Ft	1 Ton/HR [12000 BTU]	TONHR																																																																																																																																																					
Oil Barrels	Oil Barr [42 US Gallons]	Kilojoule	kJ																																																																																																																																																					
Liquid Barrels	Liq Barr [31.5 US Gallons]	Kilowatt	kWH																																																																																																																																																					
Feet	Feet	Megawatt	MWH																																																																																																																																																					
Meters	Meters																																																																																																																																																							
RATE INT	Time interval for flow rate	SEC MIN HOUR DAY	<p>Seconds Minutes Hours Days</p> <p>Select a time interval for flow rate measurements.</p>																																																																																																																																																					

**Basic Menu (BSC) continued**

Parameter	Meaning	Options	Description																																								
TOTL UNT	Totalizer units	Select an engineering unit for flow totalizer measurements. <table border="1" style="width: 100%; border-collapse: collapse;"> <tr> <td>US Gallons</td> <td><i>US Gallons</i></td> <td>Pounds</td> <td><i>LB</i></td> </tr> <tr> <td>Liters</td> <td><i>Liters</i></td> <td>Kilograms</td> <td><i>KG</i></td> </tr> <tr> <td>Millions of US Gallons</td> <td><i>MGal</i></td> <td>British Thermal Units</td> <td><i>BTU</i></td> </tr> <tr> <td>Cubic Feet</td> <td><i>Cubic Ft</i></td> <td>Thousands of BTUs</td> <td><i>MBTU</i></td> </tr> <tr> <td>Cubic Meters</td> <td><i>Cubic Me</i></td> <td>Millions of BTUs</td> <td><i>MMBTU</i></td> </tr> <tr> <td>Acre Feet</td> <td><i>Acre Ft</i></td> <td>1 Ton/HR = 12000 BTU</td> <td><i>TONHR</i></td> </tr> <tr> <td>Oil Barrels</td> <td><i>Oil Barr [42 US Gallons]</i></td> <td>Kilojoule</td> <td><i>kJ</i></td> </tr> <tr> <td>Liquid Barrels</td> <td><i>Liq Barr [31.5 US Gallons]</i></td> <td>Kilowatt</td> <td><i>kWH</i></td> </tr> <tr> <td>Feet</td> <td><i>Feet</i></td> <td>Megawatt</td> <td><i>MWH</i></td> </tr> <tr> <td>Meters</td> <td><i>Meters</i></td> <td></td> <td></td> </tr> </table>		US Gallons	<i>US Gallons</i>	Pounds	<i>LB</i>	Liters	<i>Liters</i>	Kilograms	<i>KG</i>	Millions of US Gallons	<i>MGal</i>	British Thermal Units	<i>BTU</i>	Cubic Feet	<i>Cubic Ft</i>	Thousands of BTUs	<i>MBTU</i>	Cubic Meters	<i>Cubic Me</i>	Millions of BTUs	<i>MMBTU</i>	Acre Feet	<i>Acre Ft</i>	1 Ton/HR = 12000 BTU	<i>TONHR</i>	Oil Barrels	<i>Oil Barr [42 US Gallons]</i>	Kilojoule	<i>kJ</i>	Liquid Barrels	<i>Liq Barr [31.5 US Gallons]</i>	Kilowatt	<i>kWH</i>	Feet	<i>Feet</i>	Megawatt	<i>MWH</i>	Meters	<i>Meters</i>		
US Gallons	<i>US Gallons</i>	Pounds	<i>LB</i>																																								
Liters	<i>Liters</i>	Kilograms	<i>KG</i>																																								
Millions of US Gallons	<i>MGal</i>	British Thermal Units	<i>BTU</i>																																								
Cubic Feet	<i>Cubic Ft</i>	Thousands of BTUs	<i>MBTU</i>																																								
Cubic Meters	<i>Cubic Me</i>	Millions of BTUs	<i>MMBTU</i>																																								
Acre Feet	<i>Acre Ft</i>	1 Ton/HR = 12000 BTU	<i>TONHR</i>																																								
Oil Barrels	<i>Oil Barr [42 US Gallons]</i>	Kilojoule	<i>kJ</i>																																								
Liquid Barrels	<i>Liq Barr [31.5 US Gallons]</i>	Kilowatt	<i>kWH</i>																																								
Feet	<i>Feet</i>	Megawatt	<i>MWH</i>																																								
Meters	<i>Meters</i>																																										
TOTL E	Flow totalizer exponent value	E(-1)...E6	Used for setting the flow totalizer exponent. This feature is useful for accommodating a very large accumulated flow or to increase totalizer resolution when flows are small (displaying fractions of whole barrels, gallons, etc.) The exponent is a $\times 10^n$ multiplier, where "n" can be from $-1 (\times 0.1) \dots 6 (\times 1000,000)$ . Table 9 should be referenced for valid entries and their influence on the display. Selection of E-1 and E0 adjusts the decimal point on the display. Selection of E1, E2 and E3 causes an icon of $\times 10$ , $\times 100$ or $\times 1000$ respectively to appear to the right of the total flow display value. <table border="1" style="width: 100%; border-collapse: collapse;"> <thead> <tr> <th>Exponent</th> <th>Display Multiplier</th> </tr> </thead> <tbody> <tr> <td>E-1</td> <td><math>\times 0.1 (\div 10)</math></td> </tr> <tr> <td>E0</td> <td><math>\times 1</math> (no multiplier)</td> </tr> <tr> <td>E1</td> <td><math>\times 10</math></td> </tr> <tr> <td>E2</td> <td><math>\times 100</math></td> </tr> <tr> <td>E3</td> <td><math>\times 1000</math></td> </tr> <tr> <td>E4</td> <td><math>\times 10,000</math></td> </tr> <tr> <td>E5</td> <td><math>\times 100,000</math></td> </tr> <tr> <td>E6</td> <td><math>\times 1000,000</math></td> </tr> </tbody> </table>	Exponent	Display Multiplier	E-1	$\times 0.1 (\div 10)$	E0	$\times 1$ (no multiplier)	E1	$\times 10$	E2	$\times 100$	E3	$\times 1000$	E4	$\times 10,000$	E5	$\times 100,000$	E6	$\times 1000,000$																						
Exponent	Display Multiplier																																										
E-1	$\times 0.1 (\div 10)$																																										
E0	$\times 1$ (no multiplier)																																										
E1	$\times 10$																																										
E2	$\times 100$																																										
E3	$\times 1000$																																										
E4	$\times 10,000$																																										
E5	$\times 100,000$																																										
E6	$\times 1000,000$																																										
MIN RATE	Minimum flow rate settings	(Enter a numeric value)	A minimum rate setting is entered to establish filter software settings and the lowest rate value that will be displayed. Volumetric entries will be in the rate units and interval selected previously. For unidirectional measurements, set <i>MIN RATE</i> to zero. For bidirectional measurements, set <i>MIN RATE</i> to the highest negative (reverse) flow rate expected in the piping system.  <b>NOTE:</b> The transmitter will not display a flow rate at flows less than the <i>MIN RATE</i> value. As a result, if the <i>MIN RATE</i> is set to a value greater than zero, the transmitter will display the <i>MIN RATE</i> value, even if the actual flow/energy rate is less than the <i>MIN RATE</i> .  For example, if the <i>MIN RATE</i> is set to 25 and actual rate is 0, the transmitter display will indicate 25. Another example, if the <i>MIN RATE</i> is set to -100 and the actual flow is -200, the transmitter will indicate -100. This can be a problem if the transmitter <i>MIN RATE</i> is set to a value greater than zero because at flows below the <i>MIN RATE</i> the rate display will show zero flow, but the totalizer which is not affected by the <i>MIN RATE</i> setting will keep totalizing.																																								
MAX RATE	Maximum flow rate settings	(Enter a numeric value)	A maximum volumetric flow rate setting is entered to establish filter software settings. Volumetric entries will be in the rate units and Interval selected previously. For unidirectional measurements, set <i>MAX RATE</i> to the highest (positive) flow rate expected in the piping system. For bidirectional measurements, set <i>MAX RATE</i> to the highest (positive) flow rate expected in the piping system.																																								
FL C-OFF	Flow cutoff	(Enter a numeric value)	A low flow cutoff entry is provided to allow very low flow rates (that can be present when pumps are off and valves are closed) to be displayed as zero flow. Typical values that should be entered are between 1.0% and 5.0% of the flow range between <i>MIN RATE</i> and <i>MAX RATE</i> .																																								
DAMP PER	System damping value	0...100%	Flow filter damping establishes a maximum adaptive filter value. Under stable flow conditions (flow varies less than 10% of reading), this adaptive filter will increase the number of successive flow readings that are averaged together up to this maximum value. If flow changes outside of the 10% window, the flow filter adapts by decreasing the number of averaged readings which allows the transmitter to react faster. Increasing this value tends to provide smoother steady-state flow readings and outputs. If very erratic flow conditions are present or expected, other filters are available for use in the UltraLink software utility.																																								

## Channel 1 Menu (CH1)

The *CH1* menu controls how the 4-20 mA output is spanned for all transmitter models and how the frequency output is spanned for the flow-only model.

Parameter	Meaning	Description
FL 4MA	Flow at 4 mA	<p>The FL 4MA and FL 20MA settings are used to set the span for both the 4-20 mA output and the 0...1000 Hz frequency output on the Flow-Only models.</p> <p>The 4-20 mA output is internally powered (current sourcing) and can span negative to positive flow/energy rates. This output interfaces with virtually all recording and logging systems by transmitting an analog current that is proportional to system flow rate. Independent 4 mA and 20 mA span settings are established in firmware using the flow measuring range entries. These entries can be set anywhere in the -40...40 fps (-12...12 mps) range of the instrument. Resolution of the output is 12-bits (4096 discrete points) and the can drive up to a 400 Ohm load when the transmitter is AC powered. When powered by a DC supply, the load is limited by the input voltage supplied to the instrument. See <i>Figure 23</i> for allowable loop loads.</p> <p><i>FL 4MA</i> — Flow at 4 mA <i>FL 20MA</i> — Flow at 20 mA</p> <p>The <i>FL 4MA</i> and <i>FL 20MA</i> entries are used to set the span of the 4-20 mA analog output and the frequency output on Flow-Only models. These entries are volumetric rate units that are equal to the volumetric units configured as <i>RATE UNT</i> and <i>RATE INT</i> discussed previously.</p> <p>For example, to span the 4-20 mA output from -100...100 gpm, with 12 mA being 0 gpm, set the <i>FL 4MA</i> and <i>FL 20MA</i> inputs as follows:</p> <p><i>FL 4MA</i> = -100.0 <i>FL 20MA</i> = 100.0</p> <p>If the transmitter were a Flow-Only model, this setting would also set the span for the frequency output. At -100 gpm, the output frequency would be 0 Hz. At the maximum flow of 100 gpm, the output frequency would be 1000 Hz, and in this instance a flow of zero would be represented by an output frequency of 500 Hz.</p> <p>Example 2 – To span the 4-20 mA output from 0...100 gpm, with 12 mA being 50 gpm, set the <i>FL 4MA</i> and <i>FL 20MA</i> inputs as follows:</p> <p><i>FL 4MA</i> = 0.0 <i>FL 20MA</i> = 100.0</p> <p>For the Flow-Only model, in this instance zero flow would be represented by 0 Hz and 4 mA. The full scale flow or 100 gpm would be 1000 Hz and 20 mA, and a midrange flow of 50 gpm would be expressed as 500 Hz and 12 mA.</p>
FL 20MA	Flow at 20 mA	
CAL 4MA	4 mA calibration	<p>The 4-20 mA output is factory calibrated and should not require adjustment. If small adjustments to the DAC (Digital to Analog Converter) are needed, for instance if adjustment due to the accumulation of line losses from long output cable lengths are required, the CAL 4mA and CAL 20 MA can be used.</p> <p><i>CAL 4 MA</i> — 4 mA DAC Calibration Entry (Value) <i>CAL 20 MA</i>— 20 mA DAC Calibration Entry (Value)</p> <p>The <i>CAL 4MA</i> and <i>CAL 20 MA</i> entries allow fine adjustments to be made to the zero and full scale of the 4-20 mA output. To adjust the outputs, an ammeter or reliable reference connection to the 4-20 mA output must be present.</p> <p><b>NOTE:</b> Calibration of the 20 mA setting is conducted much the same way as the 4 mA adjustments.</p> <p><b>NOTE:</b> The <i>CAL 4MA</i> and <i>CAL 20MA</i> entries should not be used in an attempt to set the 4-20 mA range. Use <i>FL 4MA</i> and <i>FL 20MA</i>, detailed above, for this purpose.</p>
CAL 20 MA	20 mA calibration	
4-20 TST	4-20 mA test	Allows a simulated flow value to be sent from the 4-20 mA output. By incrementing this value, the 4-20 mA output will transmit the indicated current value.

### 4 mA Calibration Procedure

1. Disconnect one side of the current loop and connect the ammeter in series (disconnect either wire at the terminals labeled 4-20 mA Out or Signal Gnd).
2. Using the arrow keys, increase the numerical value to increase the current in the loop to 4 mA. Decrease the value to decrease the current in the loop to 4 mA. Typical values range between 40...80 counts.
3. Reconnect the 4-20 mA output circuitry as required.

### **20 mA Calibration Procedure**

1. Disconnect one side of the current loop and connect the ammeter in series (disconnect either wire at the terminals labeled 4-20 mA Out or Signal Gnd).
2. Using the arrow keys, increase the numerical value to increase the current in the loop to 20 mA. Decrease the value to decrease the current in the loop to 20 mA. Typical values range between 3700...3900 counts.
3. Reconnect the 4-20 mA output circuitry as required.

## Channel 2 Menu (CH2)

The CH2 menu is used to configure model specific I/O options. The Flow-Only model presents a different set of parameters than the Energy model.

### Options Menu

**CAUTION**

**IT IS POSSIBLE TO CHOOSE OPTIONS PERTAINING ONLY TO THE FLOW-ONLY MODEL WHEN AN ENERGY MODEL IS PRESENT. THE OPPOSITE IS ALSO TRUE. THE PROPER MENU TYPE MUST BE CHOSEN FOR THE ACTUAL METER. FOLLOW THIS CAUTION OR TRANSMITTER READINGS WILL BE UNPREDICTABLE.**

Parameter	Meaning	Options	Description
RTD	Input values for <b>Energy models</b> .	RTD1 A Calibration Value for RTD1 A RTD1 B Calibration Value for RTD1 B RTD2 A Calibration Value for RTD2 A RTD2 B Calibration Value for RTD2 B	Inputs from two 1000 Ohm platinum RTD temperature sensors allow measurements of heating or cooling usage.  The values used to calibrate the RTD temperature sensors are derived in the laboratory and are specific to the RTD and to the electronic circuit it is connected to. The RTDs on new transmitters come with the calibration values already entered into the Energy model and should not need to be changed.  Field replacement of RTDs is possible thru the use of the keypad or the UltraLink software utility. If the RTDs were ordered from the manufacturer, they will come with calibration values that need to be loaded into the Energy model.  New, non-calibrated RTDs will need to be field calibrated using an ice bath and boiling water to derive calibration values. See "Replacing RTDs" on page 33.
CONTROL/ HZ	Output options for <b>Flow-Only models</b> . Scroll to the end of the Options menu to select CONTROL 1, CONTROL 2 or TOT MULT.	The setup options for both CONTROL 1 and CONTROL 2 follow the same menu path. For a complete view of the menu options, see "Menu Maps" on page 64.  <b>Select one of the following:</b>	Two independent open collector transistor outputs are included with the Flow-Only model. Each output can be configured independently.
	CONTROL 1 or CONTROL 2 Function of CONTROL 1 or CONTROL 2 digital output	FLOW—Flow Alarm Values	Output turns on when flow is at or above the ON flow rate and turns off when flow falls to or below the OFF flow rate. See "Rate Alarm Outputs" on page 27.
		SIG STR—Signal Strength Alarm Values	Output turns on when signal strength is at or above the ON signal strength and turns off when signal strength falls to or below the OFF signal strength.
		ERRORS	Outputs on any error condition.
		NONE	Outputs disabled.
		POSTOTAL	Output totalizing pulse for positive flow based on TOT MULT.
	TOT MULT* Totalizer multiplier for CONTROL 1 or CONTROL 2	(Enter a numeric value)	Sets the multiplier value applied to the totalizing pulse output if POSTOTAL or NEGTOTAL is selected for the output.
	ON*	(Enter a numeric value)	Sets value at which the alarm output will turn ON.
OFF*	(Enter a numeric value)	Sets value at which the alarm output will turn OFF.	
RTD POS	RTD position	NORMAL SWAPPED	In cases that the RTD1 and RTD2 are mounted on the opposite pipes, the parameter allows the RTD positions to be swapped virtually.

\* TOT MULT, ON, and OFF parameters will appear when the corresponding option is selected.

## Sensor Menu (SEN)

The *SEN MENU* allows access to the various types of transducers the transmitter can work with. Selecting the proper transducers in conjunction with the transducer mount *XDCR MNT* and transducer frequency *XDCR HZ* is critical to accurate operation of the transmitter.

Parameter	Meaning	Options	Description	
XDCR TYPE	Transducer Type	DTTR	(Use DTTN)	
		DTTN	Used on pipes 2 inches (51 mm) and larger	
		DTTH	High temperature version of DTTN	
		DTTL	Used on pipes 24 inches (600 mm) and larger	
		For pipes 24 inches (600 mm) and larger the DTTL transducers using a transmission frequency of 500 kHz are recommended.		
		DTTL transducers may also be advantageous on pipes between 4...24 inches if there are less quantifiable complicating aspects such as, sludge, tuberculation, scale, rubber liners, plastic liners, thick mortar, gas bubbles, suspended solids, emulsions, or pipes that are perhaps partially buried where a V-mount is required.		
		DT1500	Used with the M5-1500 and D1500 legacy transmitters.	
		COP TUBE	1/2...1-1/2 in. copper tubing used with DTTS and DTTC small pipe transducers	
		ASA PIPE	3/4...1-1/2 in. ANSI schedule pipes used with DTTS and DTTC small pipe transducers	
		TUBING	3/4 in. or larger stainless steel tubing used with DTTS and DTTC small pipe transducers	
		1/2 TUBE	1/2 in. stainless steel tubing used with DTTS and DTTC small pipe transducers	
		1/2 PIPE	1/2 in. ANSI schedule pipe (steel, PVC and so on) used with DTTS and DTTC small pipe transducers	
		1 INCH W	1 in. wetted transducer	
		2 IN PIPE	2 in. ANSI schedule pipe used with DTTS and DTTC small pipe transducers	
2 IN COPPER	2 in. copper tubing used with DTTS and DTTC small pipe transducers			

## Security Menu (SEC)

The *SEC MENU* menu allows access to transmitter functions that may need to be protected from changes.

Parameter	Meaning	Options	Description
TOT RES	Totalizer reset	YES NO	Resets the totalizing displayed on the LCD to zero.
SYS RSET	System reset	YES NO	Restarts the transmitter's microprocessor. This is similar to power cycling the transmitter.
CH PSWD	Change password	0...9999	The password comes from the factory set to 0000. When set to 0000 the password function is disabled. By changing the password from 0000 to some other value (any value between 0001...9999), configuration parameters will not be accessible without first entering the password value when prompted. If the value is left at 0000, no security is invoked and unauthorized changes can be made. Access to resetting of the totalizer is also protected by this password. If the password is lost or forgotten, contact the manufacturer for a universal password to unlock the transmitter.



## Service Menu (SER)

The *SER MENU* menu allows access to transmitter setup values that may need revision due to application-specific conditions and information valuable in troubleshooting.

Parameter	Meaning	Description																																																																																																																								
SSPD MPS	Liquid sound speed in meters per second, reported by the firmware	The transmitter performs an actual speed-of-sound calculation for the liquid it is measuring. The calculation varies with temperature, pressure and fluid composition. The transmitter compensates for fluid sound speeds that vary within a window of $\pm 10\%$ of the liquid specified in the <i>BSC MENU</i> . If this range is exceeded, error code 0011 appears on the display and you must correct the sound speed entry.																																																																																																																								
SSPD FPS	Liquid sound speed in feet per second	The value indicated in <i>SSPD</i> measurement should be within 10% of the value specified in the <i>BSC MENU</i> item <i>FLUID SS</i> . (The <i>SSPD</i> value itself cannot be edited.) If the actual measured value is significantly different ( $> \pm 10\%$ ) than the <i>BSC MENU</i> 's <i>FLUID SS</i> value, there may be a problem with the instrument setup. An entry such as <i>FL TYPE</i> , <i>PIPE OD</i> or <i>PIPE WT</i> may be in error, the pipe may not be round or the transducer spacing is not correct. The following table lists sound speed values for water at varying temperatures. If the transmitter is measuring sound speed within 2% of the table values, then the installation and setup of the instrument is correct. <table border="1"> <thead> <tr> <th colspan="2">Temperature</th> <th colspan="2">Velocity</th> <th colspan="2">Temperature</th> <th colspan="2">Velocity</th> <th colspan="2">Temperature</th> <th colspan="2">Velocity</th> </tr> <tr> <th>°C</th> <th>°F</th> <th>mps</th> <th>fps</th> <th>°C</th> <th>°F</th> <th>mps</th> <th>fps</th> <th>°C</th> <th>°F</th> <th>mps</th> <th>fps</th> </tr> </thead> <tbody> <tr><td>0</td><td>32</td><td>1402</td><td>4600</td><td>80</td><td>176</td><td>1554</td><td>5098</td><td>160</td><td>320</td><td>1440</td><td>4724</td></tr> <tr><td>10</td><td>50</td><td>1447</td><td>4747</td><td>90</td><td>194</td><td>1550</td><td>5085</td><td>170</td><td>338</td><td>1412</td><td>4633</td></tr> <tr><td>20</td><td>68</td><td>1482</td><td>4862</td><td>100</td><td>212</td><td>1543</td><td>5062</td><td>180</td><td>356</td><td>1390</td><td>4560</td></tr> <tr><td>30</td><td>86</td><td>1509</td><td>4951</td><td>110</td><td>230</td><td>1532</td><td>5026</td><td>190</td><td>374</td><td>1360</td><td>4462</td></tr> <tr><td>40</td><td>104</td><td>1529</td><td>5016</td><td>120</td><td>248</td><td>1519</td><td>4984</td><td>200</td><td>392</td><td>1333</td><td>4373</td></tr> <tr><td>50</td><td>122</td><td>1543</td><td>5062</td><td>130</td><td>266</td><td>1503</td><td>4931</td><td>220</td><td>428</td><td>1268</td><td>4160</td></tr> <tr><td>60</td><td>140</td><td>1551</td><td>5089</td><td>140</td><td>284</td><td>1485</td><td>4872</td><td>240</td><td>464</td><td>1192</td><td>3911</td></tr> <tr><td>70</td><td>158</td><td>1555</td><td>5102</td><td>150</td><td>302</td><td>1466</td><td>4810</td><td>260</td><td>500</td><td>1110</td><td>3642</td></tr> </tbody> </table>	Temperature		Velocity		Temperature		Velocity		Temperature		Velocity		°C	°F	mps	fps	°C	°F	mps	fps	°C	°F	mps	fps	0	32	1402	4600	80	176	1554	5098	160	320	1440	4724	10	50	1447	4747	90	194	1550	5085	170	338	1412	4633	20	68	1482	4862	100	212	1543	5062	180	356	1390	4560	30	86	1509	4951	110	230	1532	5026	190	374	1360	4462	40	104	1529	5016	120	248	1519	4984	200	392	1333	4373	50	122	1543	5062	130	266	1503	4931	220	428	1268	4160	60	140	1551	5089	140	284	1485	4872	240	464	1192	3911	70	158	1555	5102	150	302	1466	4810	260	500	1110	3642
Temperature		Velocity		Temperature		Velocity		Temperature		Velocity																																																																																																																
°C	°F	mps	fps	°C	°F	mps	fps	°C	°F	mps	fps																																																																																																															
0	32	1402	4600	80	176	1554	5098	160	320	1440	4724																																																																																																															
10	50	1447	4747	90	194	1550	5085	170	338	1412	4633																																																																																																															
20	68	1482	4862	100	212	1543	5062	180	356	1390	4560																																																																																																															
30	86	1509	4951	110	230	1532	5026	190	374	1360	4462																																																																																																															
40	104	1529	5016	120	248	1519	4984	200	392	1333	4373																																																																																																															
50	122	1543	5062	130	266	1503	4931	220	428	1268	4160																																																																																																															
60	140	1551	5089	140	284	1485	4872	240	464	1192	3911																																																																																																															
70	158	1555	5102	150	302	1466	4810	260	500	1110	3642																																																																																																															
SIG STR	Signal strength reported by the firmware	The <i>SIG STR</i> value is a relative indication of the amount of ultrasound making it from the transmitting transducer to the receiving transducer. The signal strength is a blending of esoteric transit time measurements distilled into a usable overall reference. The measurement of signal strength assists service personnel in troubleshooting the transmitter system. In general, expect the signal strength readings to be greater than five on a full pipe with the transducers properly mounted. Signal strength readings that are less than five indicate a need to choose an alternative mounting method for the transducers or that an improper pipe size has been entered. Signal strength below the low signal cutoff <i>SIG C-OF</i> value will generate a 0010 error (Low Signal Strength) and require either a change in the <i>SIG C-OF</i> value or transducer mounting changes. <b>NOTE:</b> If the transmitter is configured to display totalizer values, the display will alternate between error 0010 and the totalizer value. Signal strength readings in excess of 98 may indicate that a mounting method with a longer path length may be required. For example, if transducers mounted on a 3 inch PVC pipe in V-Mount cause the measured signal strength value to exceed 98, change the mounting method to W-Mount for greater stability in readings. Because signal strength is not an absolute indication of how well a transmitter is functioning, there is no real advantage to a signal strength of 50 over a signal strength of 10.																																																																																																																								
SIG C-OF	Low signal cutoff value	Options: 0.0...100.0 <b>NOTE:</b> The factory default Signal Strength Cutoff is 5. If the measured signal strength is lower than the <i>SIG C-OF</i> setting, an error 0010 will be shown on the transmitter's display until the measured signal strength becomes greater than the cutoff value. A signal strength indication below 2 is considered to be no signal at all. Verify that the pipe is full of liquid, the pipe size and liquid parameters are entered correctly, and that the transducers have been mounted accurately. Highly aerated liquids will also cause low signal strength conditions.																																																																																																																								
TEMP 1 C	Temperature of RTD 1	Reported by the firmware in °C. When RTD is selected from the <i>CH2</i> menu and RTDs are connected to the Energy model, the firmware will display the temperature measured by RTD 1 in °C.																																																																																																																								
TEMP 1 F	Temperature of RTD 1	Reported by the firmware in °F. When RTD is selected from the <i>CH2</i> menu and RTDs are connected to the Energy model, the firmware will display the temperature measured by RTD 1 in °F.																																																																																																																								
TEMP 2 C	Temperature of RTD 2	Reported by the firmware in °C. When RTD is selected from the <i>CH2</i> menu and RTDs are connected to the Energy model, the firmware will display the temperature measured by RTD 2 in °C.																																																																																																																								
TEMP 2 F	Temperature of RTD 2	Reported by the firmware in °F. When RTD is selected from the <i>CH2</i> menu and RTDs are connected to the Energy model, the firmware will display the temperature measured by RTD 2 in °F.																																																																																																																								
TEMP DIFF C	Temperature difference	Reported by the firmware in °C. When RTD is selected from the <i>CH2</i> menu and RTDs are connected to the Energy model, the firmware will display the difference in temperature measured between RTD 1 and RTD 2 in °C.																																																																																																																								
TEMP DIFF F	Temperature difference	Reported by the firmware in °F. When RTD is selected from the <i>CH2</i> menu and RTDs are connected to the Energy model, the firmware will display the difference in temperature measured between RTD 1 and RTD 2 in °F.																																																																																																																								

**Service Menu (SER) continued**

Parameter	Meaning	Options	Description																				
SUB FLOW	Substitute flow value	0.0...100.0	<p>Substitute Flow <i>SUB FLOW</i> is a value that the analog outputs and the flow rate display will indicate when an error condition in the transmitter occurs. The typical setting for this entry is a value that will make the instrument display zero flow during an error condition.</p> <p>Substitute flow is set as a percentage between <i>MIN RATE</i> and <i>MAX RATE</i>. In a unidirectional system, this value is typically set to zero to indicate zero flow while in an error condition. In a bidirectional system, the percentage can be set such that zero is displayed in a error condition. To calculate where to set the substitute flow value in a bidirectional system, perform the following calculation:</p> $\text{Substitute Flow} = 100 - \frac{100 \times \text{Maximum Flow}}{\text{Maximum Flow} - \text{Minimum Flow}}$ <p>Some typical settings to achieve zero with respect to <i>MIN RATE</i> and <i>MAX RATE</i> settings are listed below.</p> <p><b>NOTE:</b> *The UltraLink software utility is required to set values outside of 0.0...100.0.</p> <table border="1"> <thead> <tr> <th>Min Rate Setting</th> <th>Max Rate Setting</th> <th>Sub Flow Setting</th> <th>Display Reading During Errors</th> </tr> </thead> <tbody> <tr> <td>0.0</td> <td>1000.0</td> <td>0.0</td> <td>0.000</td> </tr> <tr> <td>-500.0</td> <td>500.0</td> <td>50.0</td> <td>0.000</td> </tr> <tr> <td>-100.0</td> <td>200.0</td> <td>33.3</td> <td>0.000</td> </tr> <tr> <td>0.0</td> <td>1000.0</td> <td>-5.0*</td> <td>-50.00</td> </tr> </tbody> </table>	Min Rate Setting	Max Rate Setting	Sub Flow Setting	Display Reading During Errors	0.0	1000.0	0.0	0.000	-500.0	500.0	50.0	0.000	-100.0	200.0	33.3	0.000	0.0	1000.0	-5.0*	-50.00
Min Rate Setting	Max Rate Setting	Sub Flow Setting	Display Reading During Errors																				
0.0	1000.0	0.0	0.000																				
-500.0	500.0	50.0	0.000																				
-100.0	200.0	33.3	0.000																				
0.0	1000.0	-5.0*	-50.00																				
SET ZERO	Set zero flow point	NO YES	<p>Because every transmitter installation is slightly different and sound waves can travel in slightly different ways through these various installations, it is important to remove the zero offset at zero flow to maintain the transmitter's accuracy. A provision is made using this entry to establish "Zero" flow and eliminate the offset.</p> <ol style="list-style-type: none"> <li>1. The pipe must be full of liquid.</li> <li>2. Flow must be absolute zero - securely close any valves and allow time for any settling to occur.</li> <li>3. Press <b>ENTER</b>, use the arrow <b>▲▼</b> keys to make the display read <b>YES</b>.</li> <li>4. Press <b>ENTER</b>.</li> </ol>																				
D-FLT 0	Set default zero point	NO YES	<p>If the flow in a piping system cannot be shut off, allowing the <b>SET ZERO</b> procedure described above to be performed or if an erroneous "zero" flow was captured - like can happen if <b>SET ZERO</b> is conducted with flowing fluid, then the factory default zero should be used. To use the <b>D-FLT 0</b> function, simply press <b>ENTER</b>, then press an arrow <b>▲▼</b> key to display <b>YES</b> on the display and then press <b>ENTER</b>.</p> <p>The default zero places an entry of zero (0) into the firmware instead of the actual zero offset entered by using the <b>SET ZERO</b> procedure.</p>																				
COR FTR	Correction Factor	0.500...1.500	<p>This function can be used to make the transmitter agree with a different (or reference) transmitter by applying a correction factor / multiplier to the readings and outputs. A factory calibrated system should be set to 1.000. The range of settings for this entry is 0.500 to 1.500. The following examples describe two uses for the <b>COR FTR</b> entry:</p> <ul style="list-style-type: none"> <li>• The transmitter is indicating a flow rate that is 4% higher than another transmitter located in the same pipe line. To make the transmitter indicate the same flow rate as the other transmitter, enter a <b>COR FTR</b> of 0.960 to lower the readings by 4%.</li> <li>• An out-of-round pipe, carrying water, causes the transmitter to indicate a measured sound speed that is 7.4% lower than the <b>Table 4.5</b> value. This pipe condition will cause the transmitter to indicate flow rates that are 7.4% lower than actual flow. To correct the flow readings, enter 1.074.</li> </ul>																				

## Display Menu (DSP)

The **DISPLAY** menu parameters control what is shown on the display and the rate at which displayed items alternate (dwell time).

Parameter	Meaning	Options	Description
DISPLAY	Display	FLOW TOTAL BOTH	The transmitter will only display the flow rate with the <b>DISPLAY</b> set to <b>FLOW</b> - it will not display the total flow. The transmitter will only display the total flow with the <b>DISPLAY</b> set to <b>TOTAL</b> - it will not display the flow rate. By selecting <b>BOTH</b> , the display will alternate between <b>FLOW</b> and <b>TOTAL</b> at the interval selected in <b>SCN DWL</b> .
TOTAL	Totalizer options	POS, Positive Flow Only NEG, Negative Flow Only NET, Net Flow BATCH, Batch Mode	Select <b>POS</b> to view the positive direction total only. Select <b>NEG</b> to view the negative direction total only. Select <b>NET</b> to display the net difference between the positive direction and negative direction totals. Select the <b>BATCH</b> to configure the totalizer to count up to a value that is entered as <b>BTCH MUL</b> . After reaching the <b>BTCH MUL</b> value, the display will return to zero and will repeat counting to the <b>BTCH MUL</b> value.
SCN DWL	Screen display dwell time	1...10 seconds	Adjustment of <b>SCN DWL</b> sets the time interval that the display will dwell at <b>FLOW</b> and then alternately <b>TOTAL</b> values when <b>BOTH</b> is chosen from the display submenu. This adjustment range is from 1...10 seconds.
BTCH MUL	Batch multiplier	(Enter a value)	<i>BTCH MUL, Batch Multiplier (Value)</i> If <b>BATCH</b> was chosen for the totalizer mode, a value for batch accumulation must be entered. This is the value to which the totalizer will accumulate before resetting to zero and repeating the accumulation. This value includes any exponents that were entered in the <b>BSC MENU</b> as <b>TOTL E</b> . For example: <ol style="list-style-type: none"> <li>If <b>BTCH MUL</b> is set to 1000, <b>RATE UNT</b> to <b>LITERS</b> and <b>TOTL E</b> to <b>E0</b> (liters × 1), then the batch totalizer will accumulate to 1000 liters, return to zero and repeat indefinitely. The totalizer will increment 1 count for every liter that has passed.</li> <li>If <b>BTCH MUL</b> is set to 1000, <b>RATE UNT</b> to <b>LITERS</b> and <b>TOTL E</b> to <b>E2</b> (liters × 100), then the batch totalizer will accumulate to 100,000 liters, return to zero and repeat indefinitely. The totalizer will only increment 1 count for every 100 liters that has passed.</li> </ol>

## PARAMETER CONFIGURATION USING ULTRALINK SOFTWARE

The UltraLink software utility is used for configuring, calibrating and communicating with transit time flow meters. It has numerous troubleshooting tools to make diagnosing and correcting installation problems easier.

A PC can be hard-wired to the transmitter through a standard USB connection.

### System Requirements

The software requires a PC-type computer, running Windows 98, Windows ME, Windows 2000, Windows NT, Windows XP, Windows Vista or Windows 7 operating systems and a USB communications port.

### Installation

1. From the Windows *Start* button, choose the **Run** command. From the *Run* dialog box, use **Browse** to navigate to the *USP\_Setup.exe* file and double-click.
2. The USP Setup will automatically extract and install on the hard disk. The USP icon can then be copied to the desktop.

**NOTE:** If a previous version of this software is installed, it must be un-installed before a new version of the software can be installed. Newer versions will ask to remove the old version and perform the task automatically. Older versions must be removed using the Microsoft Windows Add/Remove Programs applet.

**NOTE:** Most PCs will require a restart after a successful installation.

### Initialization

1. Connect the B end of the USB 2.0 A/B communications cable (P.N. D005-2117-003) to the transmitter's USB communication port and the A end to a USB port on the computer.

**NOTE:** Power up the transmitter prior to running this software.

**NOTE:** While the USB cable is connected, the RS485 and frequency outputs are disabled.

2. Double-click the USP icon to start the software.

UltraLink software will attempt to connect to the transmitter. If communications cannot be established, you will be prompted to select a Com Port and Com Port Type. For a USB cable connection, select COM6 and RS232 / USB.

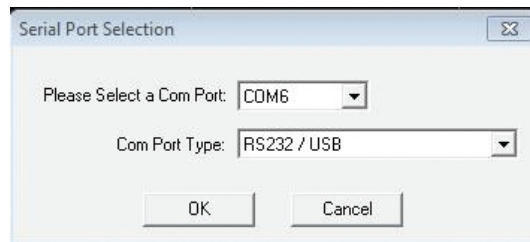

Figure 40: Serial port connection

The first screen is the *RUN* mode screen, which contains real-time information regarding flow rate, totals, signal strength, communications status, and the transmitter's serial number. The *COMM* indicator in the lower right corner indicates that the serial connection is active. If the *COMM* box contains a red *ERROR* indication, select **Communications** on the Menu bar and select **Initialize**. Choose the appropriate COM port and the RS232 / USB Com Port Type. Proper communication is verified when a green *OK* is indicated in the lower right corner of the PC display and the *Last Update* indicator in the text area on the left side of the screen changes from red to an active clock indication.

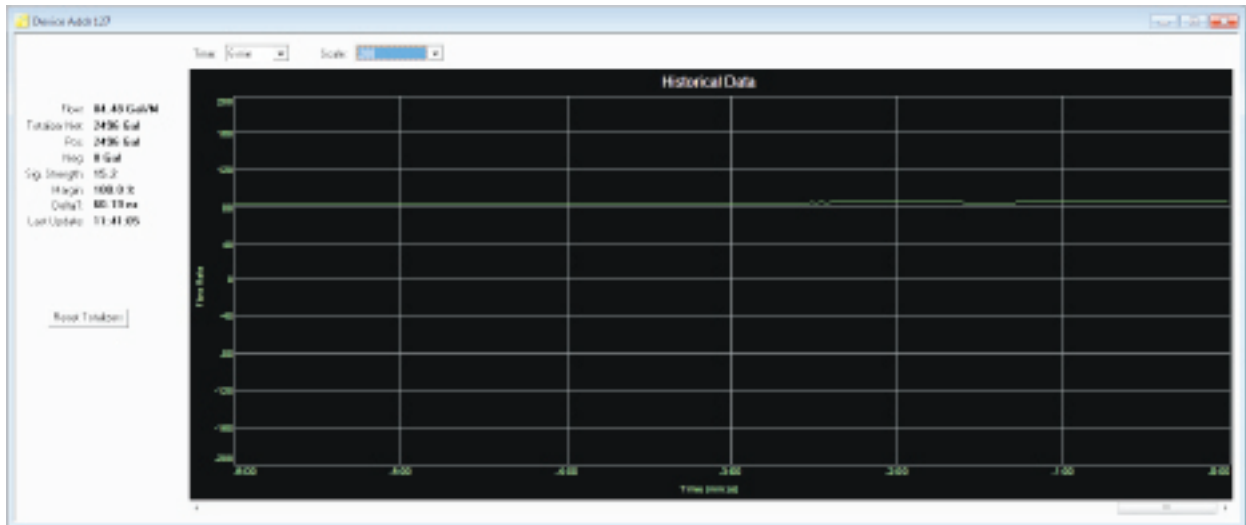
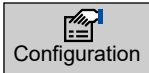

Figure 41: Data display screen

## CONFIGURATION MENU



The *Configuration* menu has six tabs used to control how the transmitter is set up and responds to varying flow conditions. The first screen that appears after clicking the Configuration button is the *Basic* tab.

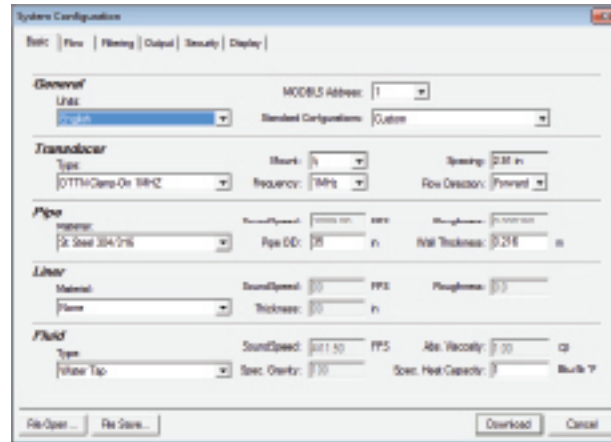

Figure 42: Basic tab

### Basic Tab

Use the *General* options to select the measurement system—**English** (inches) or **Metric** (millimeters)—for transmitter setup, and choose from a number of pre-programmed small pipe configurations in the *Standard Configurations* drop-down menu. If the general entries are altered from those at transmitter startup, click **Download** and cycle power to the transmitter.

When using the *Standard Configurations* drop-down menu alternate, menu choices can be made by using the following guidelines:

1. Select the transducer type and pipe size for the transducer to be used. The firmware will automatically enter the appropriate values for that pipe size and type. Every entry parameter except for *Units*, *Modbus Address*, *Standard Configurations*, *Frequency*, *Flow Direction* and *Specific Heat Capacity* will be unavailable behind a grayed out entry box.
2. Go back to the *Standard Configurations* drop-down menu and select **Custom**. As soon as *Custom* is chosen, the previously grayed out selections will become available for editing.
3. Make any changes to the basic configuration deemed necessary and click **Download**.
4. To ensure that the configuration changes take effect, turn the power off and then back on again to the transmitter.

Also under the *General* heading is a field for entering a Modbus address. If the transmitter is to be used on a multi-drop RS485 network, it must be assigned a unique numerical address. This box allows that unique address to be chosen.

**NOTE:** This address does not set the Modbus TCP/IP, EtherNet/IP, BACnet address. That is set via the web page interface that is integrated into the Ethernet port.

**NOTE:** Do not confuse the Modbus address with the device address as seen in the upper left-hand corner of the display. The *Device Addr* is included for purposes of backward compatibility of first generation transmitter products. The device address has no function and will not change when used with this transmitter family.

*Transducer Type* selects the transducer that will be connected to the transmitter. Select the appropriate transducer type from the drop-down list. This selection influences transducer spacing and transmitter performance, so it must be correct. If you are unsure about the type of transducer to which the transmitter will be connected, consult the shipment packing list or call the manufacturer for assistance.

**NOTE:** A change of transducer type will cause a system configuration error *1002: Sys Config Changed* to occur. This error will clear when the microprocessor is reset or power is cycled on the transmitter.

*Transducer Mount* selects the orientation of the transducers on the piping system. See “*Transducer Installation*” on page 15 and *Table 3* on page 17 for detailed information regarding transducer mounting modes for particular pipe and liquid characteristics. Whenever the transducer mounting mode is changed, a download command and subsequent microprocessor reset or transmitter power cycle must be conducted.

*Transducer Frequency* selects a transmission frequency for the various types of transducers. In general, the larger the pipe the slower the transmission frequency needs to be to attain a good signal.

Frequency	Transducers	Mounting Modes	Pipe Size and Type
2 MHz	All 1/2...1-1/2 in. Small Pipe and Tube 2 in. Tubing	Selected by Firmware	Specific to Transducer
1 MHz	2 in. ANSI Pipe and Copper Tube	Selected by Firmware	Specific to Transducer
	Standard and High Temp	W, V, and Z	2 in. and Greater
500 kHz	Large Pipe	W, V, and Z	24 in. and Greater

Table 9: Transducer Frequencies

*Transducer Spacing* is a value calculated by the transmitter’s firmware that takes into account pipe, liquid, transducer and mounting information. This spacing will adapt as these parameters are modified. The spacing is given in inches for English units selection and millimeters for metric. This value is the lineal distance that must be between the transducer alignment marks. Selection of the proper transducer mounting method is not entirely predictable and many times is an iterative process.

**NOTE:** This setting only applies to DTTR, DTTN, DTTL and DTTH transducers.

*Transducer Flow Direction* allows the change of the direction the transmitter assumes is forward. When mounting transmitters with integral transducers, use this feature to reverse upstream and downstream transducers, making upside-down mounting of the display unnecessary.

Select a *Pipe Material* the pull-down list. If the pipe material used is not found in the list, select **Other** and enter the actual pipe material *Sound Speed* and *Roughness* for pipe relative roughness calculations.

*Pipe O.D.* and *Wall Thickness* are based on the physical dimensions of the pipe on which the transducers will be mounted. Enter this value in inches for English units or millimeters for metric units.

**NOTE:** See “*North American Pipe Schedules*” on page 110 for charts listing popular pipe sizes. Correct entries for pipe O.D. and pipe wall thickness are critical to obtaining accurate flow measurement readings.

*Liner Material* is selected from the pull-down list. If the pipe liner material used is not included in the list, select **Other** and enter liner material *Sound Speed* and *Roughness*). See “*Liner material relative roughness*” on page 38 for pipe liner relative roughness calculations.

*Fluid Type* is selected from a pull-down list. If the liquid is not found in the list, select **Other** and enter the liquid *Sound Speed* and *Absolute Viscosity* into the appropriate boxes. The liquid’s specific gravity is required if mass measurements are to be made, and the specific heat capacity is required for energy measurements.

Use the *RS485 Communications* option to change the RS485 Baud Rate and BACnet MSTP Device ID (used in the Microchip communications microcontroller).



## Flow Tab

*Flow Rate Units* are selected from the drop-down lists. Select an appropriate rate unit and time from the two lists. This entry also includes the selection of *Flow Rate Interval* after the virgule (/) sign.

*Totalizer Units* are selected from dropdown lists. Select an appropriate totalizer unit and totalizer exponent. The totalizer exponents are in scientific notation and permit the eight digit totalizer to accumulate very large values before the totalizer “rolls over” and starts again at zero.

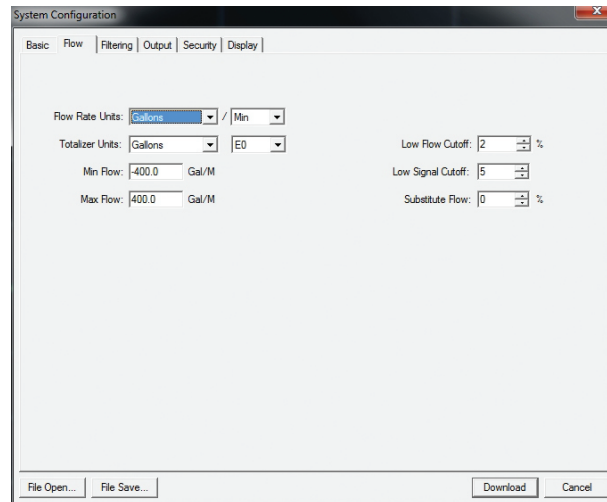

Figure 43: Flow tab

*Min Flow* is the minimum volumetric flow rate setting entered to establish filtering parameters. Volumetric entries will be in the flow rate units. For unidirectional measurements, set *Min Flow* to zero. For bidirectional measurements, set *Min Flow* to the highest negative (reverse) flow rate expected in the piping system.

*Max Flow* is the maximum volumetric flow rate setting entered to establish filtering parameters. Volumetric entries will be in the flow rate units. For unidirectional measurements, set *Max Flow* to the highest (positive) flow rate expected in the piping system. For bidirectional measurements, set *Max Flow* to the highest (positive) flow rate expected in the piping system.

*Low Flow Cutoff* is provided to allow very low flow rates (that can be present when pumps are off and valves are closed) to be displayed as zero flow. Typical values that should be entered are between 1.0...5.0% of the flow range between *Min Flow* and *Max Flow*.

*Low Signal Cutoff* is used to drive the transmitter and its outputs to the value specified in the *Substitute Flow* field when conditions occur that cause low signal strength. A signal strength indication below 5 is generally inadequate for measuring flow reliably, so generally the minimum setting for low signal cutoff is 5. A good practice is to set the low signal cutoff at approximately 60...70% of actual measured maximum signal strength. The factory default low signal cutoff is five.

If the measured signal strength is lower than the low signal cutoff setting, a *Signal Strength too Low* highlighted in red will become visible in the text area to the left in the *Data Display* screen until the measured signal strength becomes greater than the cutoff value.

Signal strength indication below two is considered to be no signal at all. Verify that the pipe is full of liquid, the pipe size and liquid parameters are entered correctly, and that the transducers have been mounted accurately. Highly aerated liquids will also cause low signal strength conditions.

*Substitute Flow* is a value that the analog outputs and the flow rate display will indicate when an error condition in the transmitter occurs. The typical setting for this entry is a value that will make the instrument display zero flow during an error condition.

Substitute flow is set as a percentage between *Min Flow* and *Max Flow*. In a unidirectional system, this value is typically set to zero to indicate zero flow while in an error condition. In a bidirectional system, the percentage can be set such that zero is displayed in an error condition. To calculate where to set the Substitute Flow value in a bidirectional system, use:

$$\text{Substitute Flow} = 100 - \frac{100 \times \text{Maximum Flow}}{\text{Maximum Flow} - \text{Minimum Flow}}$$



Entry of data in the *Basic* and *Flow* tabs is all that is required to provide flow measurement functions to the transmitter. If you are not going to use input/output functions, click **Download** to transfer the configuration to the transmitter. When the configuration has been completely downloaded, turn the power to the transmitter off and then on again to guarantee the changes take effect.

## Filtering Tab

The *Filtering* tab contains several filter settings for the transmitter. These filters can be adjusted to match response times and data “smoothing” performance to a particular application.

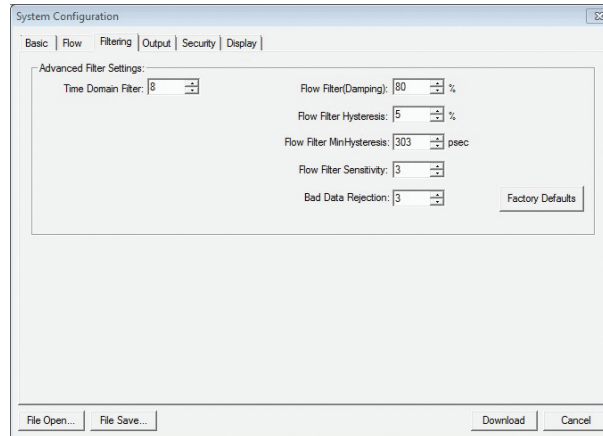

Figure 44: Filtering tab

*Time Domain Filter* (range 1...256) adjusts the number of raw data sets (the wave forms viewed on the software *Diagnostics Screen*) that are averaged together. Increasing this value will provide greater damping of the data and slow the response time of the transmitter. Conversely, lowering this value will decrease the response time of the transmitter to changes in flow/energy rate. This filter is not adaptive, it is operational to the value set at all times.

**NOTE:** The transmitter completes a measurement in approximately 350...400 mS. The exact time is pipe size dependent.

*Flow Filter* (Damping) establishes a maximum adaptive filter value. Under stable flow conditions (flow that varies less than the *Flow Filter Hysteresis* entry), this adaptive filter will increase the number of successive flow readings that are averaged together up to this maximum value. If flow changes outside of the flow filter hysteresis window, the filter adapts by decreasing the number of averaged readings and allows the transmitter to react faster.

The damping value is increased to increase stability of the flow rate readings. Damping values are decreased to allow the transmitter to react faster to changing flow rates. The factory settings are suitable for most installations. Increasing this value tends to provide smoother steady-state flow readings and outputs.

*Flow Filter Hysteresis* creates a window around the average flow measurement reading allowing small variations in flow without changing the damping value. If the flow varies within that hysteresis window, greater display damping will occur up to the maximum values set by the flow filter entry. The filter also establishes a flow rate window where measurements outside of the window are examined by the *Bad Data Rejection* filter. The value is entered as a percentage of actual flow rate.

For example, if the average flow rate is 100 gpm and the *Flow Filter Hysteresis* is set to 5%, a filter window of 95...105 gpm is established. Successive flow measurements that are measured within that window are recorded and averaged in accordance with the *Flow Filter Damping* setting. Flow readings outside of the window are held up in accordance with the *Bad Data Rejection* filter.

*Flow Filter MinHysteresis* sets a minimum hysteresis window that is invoked at sub 0.25 fps (0.08 mps) flow rates, where the “of rate” flow filter hysteresis is very small and ineffective. This value is entered in pico-seconds (psec) and is differential time. If very small fluid velocities are to be measured, increasing the flow filter minhysteresis value can increase reading stability.

*Flow Filter Sensitivity* allows configuration of how fast the *Flow Filter Damping* will adapt in the positive direction.

Increasing this value allows greater damping to occur faster than lower values. Adaptation in the negative direction is not user adjustable.

*Bad Data Rejection* is a value related to the number of successive readings that must be measured outside of the *Flow Filter Hysteresis* or *Flow Filter MinHysteresis* windows before the transmitter will use that flow value. Larger values are entered into *Bad Data Rejection* when measuring liquids that contain gas bubbles, as the gas bubbles tend to disturb the ultrasonic signals and cause more extraneous flow readings to occur. Larger *Bad Data Rejection* values tend to make the transmitter more sluggish to rapid changes in actual flow rate.

## Output Tab

The entries made in the Output tab establish input and output parameters for the transmitter. Select the appropriate function from the pull-down menu and click **Download**. When a function is changed from the factory setting, a configuration error 1002 will result. This error will be cleared by resetting the transmitter microprocessor from the Communications/Commands/**Reset Target** button or by cycling power on the transmitter. Once the proper output is selected and the microprocessor is reset, calibration and configuration of the modules can be completed.

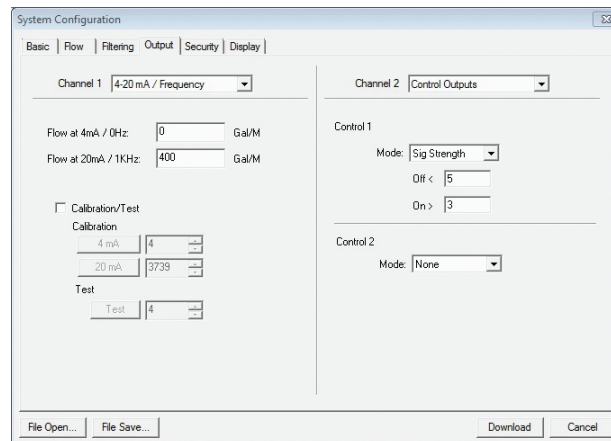

Figure 45: Output tab

### Channel 1, 4-20 mA Configuration

**NOTE:** The *4-20 mA Output* menu applies to all transmitters and is the only output choice for *Channel 1*.

The channel 1 menu controls how the 4-20 mA output is spanned for all models and how the frequency output is spanned for the flow-only model.

The *Flow at 4 mA / 0 Hz* and *Flow at 20 mA / 1000 Hz* settings are used to set the span for both the 4-20 mA output and the 0...1000 Hz frequency output on the Flow-Only model.

The 4-20 mA output is internally powered (current sourcing) and can span negative to positive flow/energy rates. This output interfaces with virtually all recording and logging systems by transmitting an analog current that is proportional to system flow rate. Independent 4 mA and 20 mA span settings are established in firmware using the flow measuring range entries. These entries can be set anywhere in the -40...40 fps (-12 ...12 mps) range of the instrument. Resolution of the output is 12 bits (4096 discrete points) and can drive up to a 400 Ohm load when the transmitter is AC powered. When powered by a DC supply, the load is limited by the input voltage supplied to the instrument. See *Figure 23* for allowable loop loads.

Flow at 4 mA / 0 Hz

Flow at 20 mA / 1000 Hz

The Flow at 4 mA / 0 Hz and Flow at 20 mA / 1000 Hz entries are used to set the span of the 4-20 mA analog output and the frequency output on Flow-Only model. These entries are volumetric rate units that are equal to the volumetric units configured as rate units and rate interval.

For example, to span the 4-20 mA output from -100...100 gpm with 12 mA being 0 gpm, set the Flow at 4 mA / 0 Hz and Flow at 20 mA / 1000 Hz inputs as follows:

Flow at 4 mA / 0 Hz = -100.0

Flow at 20 mA / 1000 Hz = 100.0

If the transmitter is a Flow-Only model, this setting would also set the span for the frequency output. At –100 gpm, the output frequency would be 0 Hz. At the maximum flow of 100 gpm, the output frequency would be 1000 Hz, and in this instance a flow of zero would be represented by an output frequency of 500 Hz.

Example 2 – To span the 4-20 mA output from 0 ... 100 gpm with 12 mA being 50 gpm, set the Flow at 4 mA / 0 Hz and Flow at 20 mA / 1000 Hz inputs as follows:

Flow at 4 mA / 0 Hz = 0.0

Flow at 20 mA / 1000 Hz = 100.0

For the transmitter, in this instance, zero flow would be represented by 0 Hz and 4 mA. The full scale flow or 100 gpm would be 1000 Hz and 20 mA and a midrange flow of 50 gpm would be expressed as 500 Hz and 12 mA.

The 4-20 mA output is factory calibrated and should not require adjustment. If small adjustments to the DAC (**D**igital to **A**nalog **C**onverter) are needed, for instance if adjustments due to the accumulation of line losses from long output cable lengths are required, the **Calibration 4 mA** and **Calibration 20 mA** can be used.

Calibration 4 mA — 4 mA DAC Calibration Entry (Value)

Calibration 20 mA— 20 mA DAC Calibration Entry (Value)

The *Calibration 4 mA* and *Calibration 20 mA* entries allows fine adjustments to be made to the “zero” and full scale of the 4-20 mA output. To adjust the outputs, an ammeter or reliable reference connection to the 4-20 mA output must be present.

**NOTE:** Calibration of the 20 mA setting is conducted much the same way as the 4 mA adjustments.

**NOTE:** The Calibration 4 mA and Calibration 20 mA entries should not be used in an attempt to set the 4-20 mA range. Use Flow at 4 mA / 0 Hz and Flow at 20 mA / 1000 Hz detailed above for this purpose.

#### 4 mA Calibration Procedure

1. Disconnect one side of the current loop and connect the ammeter in series (disconnect either wire at the terminals labeled 4-20 mA Out or Signal Gnd).
2. Using the arrow keys, increase the numerical value to increase the current in the loop to 4 mA. Decrease the value to decrease the current in the loop to 4 mA. Typical values range between 40...80 counts.
3. Reconnect the 4-20 mA output circuitry as required.

#### 20 mA Calibration Procedure

1. Disconnect one side of the current loop and connect the ammeter in series (disconnect either wire at the terminals labeled 4-20 mA Out or Signal Gnd).
2. Using the arrow keys, increase the numerical value to increase the current in the loop to 20 mA. Decrease the value to decrease the current in the loop to 20 mA. Typical values range between 3700...3900 counts.
3. Reconnect the 4-20 mA output circuitry as required.

#### 4-20 Test, 4-20 mA Output Test (Value)

Allows a simulated flow value to be sent from the 4-20 mA output. By incrementing this value, the 4-20 mA output will transmit the indicated current value.

### Channel 2, RTD Configuration for Energy Model Only

**NOTE:** The Channel 2 Menu is used to configure model specific I/O options. The Flow-Only model presents a different set of parameters than the Energy model.

**CAUTION**

**IT IS POSSIBLE TO CHOOSE OPTIONS PERTAINING ONLY TO THE FLOW-ONLY MODEL WHEN AN ENERGY MODEL IS PRESENT. THE OPPOSITE IS ALSO TRUE. THE PROPER MENU TYPE MUST BE CHOSEN FOR THE ACTUAL TRANSMITTER. IF NOT, THE OUTPUTS OR TRANSMITTER READINGS WILL BE UNPREDICTABLE.**

Inputs from two 1000 Ohm platinum RTD temperature sensors allow the measurement of energy delivered in liquid heating and cooling systems.

The values used to calibrate the RTD temperature sensors are derived in the laboratory and are specific to a specific RTD. The RTDs on new transmitters come with the calibration values already entered into the Energy model and should not need to be changed.

Field replacement of RTDs is possible thru the use of the keypad or the software. If the RTDs were ordered from the manufacturer, they will come with calibration values that need to be loaded into the Energy model.

*RTD Calibration Procedure*

1. Enter the calibration values for *RTD #1 A* and *RTD #1 B* followed by *RTD #2 A* and *RTD #2 B*.
2. Double-click **Download** to send the values to memory.
3. Turn the power off and then back on to the transmitter to enable the changes to take effect.

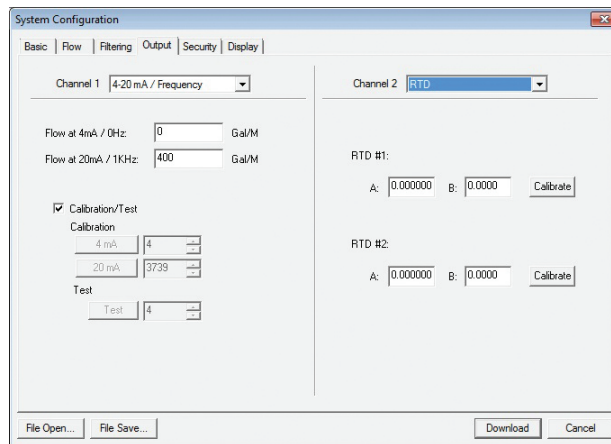

Figure 46: Channel 2 input (RTD)

New, non-calibrated RTDs will need to be field calibrated using an ice bath and boiling water to derive calibration values. See *"In-Field Calibration of RTD Temperature Sensors"* on page 92.

## Channel 2, Control Output Configuration for Flow-Only Model

Two independent open-collector transistor outputs are included with the Flow-Only model. Each output can be configured independently.

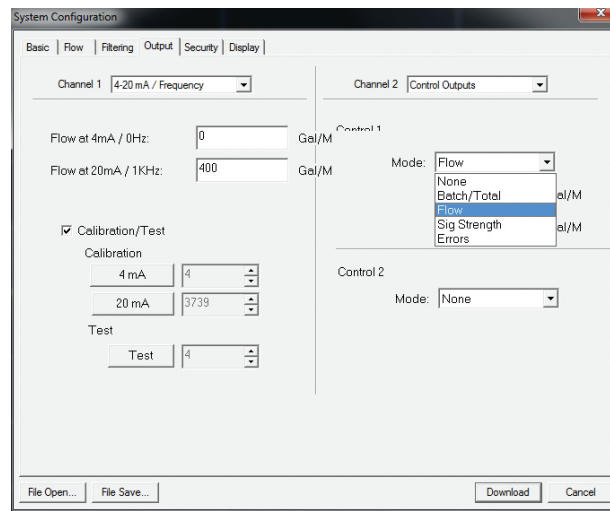

Figure 47: Channel 2 output choices

### None

All alarm outputs are disabled.

### Batch / Total

Multiplier value to which the totalizer will accumulate before resetting to zero and repeating the accumulation. This value includes any exponents that were entered in the BASIC menu as *TOTAL E*.

### Flow

ON sets value at which the alarm output will switch from OFF to ON.  
OFF sets value at which the alarm output will switch from ON to OFF.

### Signal Strength

ON sets value at which the alarm output will turn ON.  
OFF sets value at which the alarm output will turn OFF.

### Errors

Alarm outputs on any error condition. See “Brad Harrison® Connector Option” on page 95.

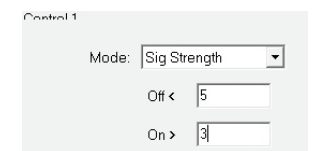
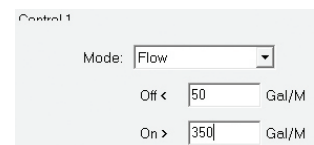

## Security Tab

Use the *Security* tab to enter your system password.

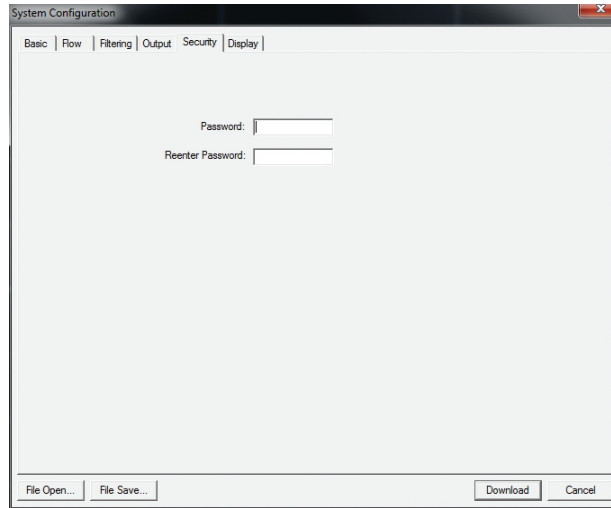

Figure 48: Security tab

## Display Tab

Use the *Display* tab to select display options.

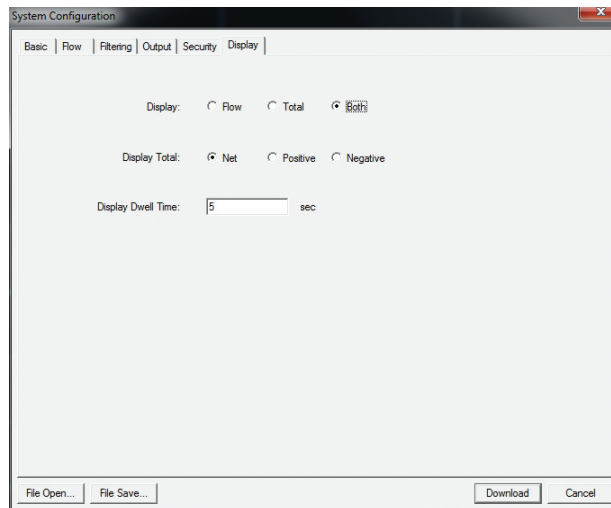
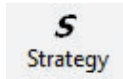

Figure 49: Display tab

## STRATEGY MENU



The *Strategy* menu parameters are factory-set. To change these parameters, call Technical Support.

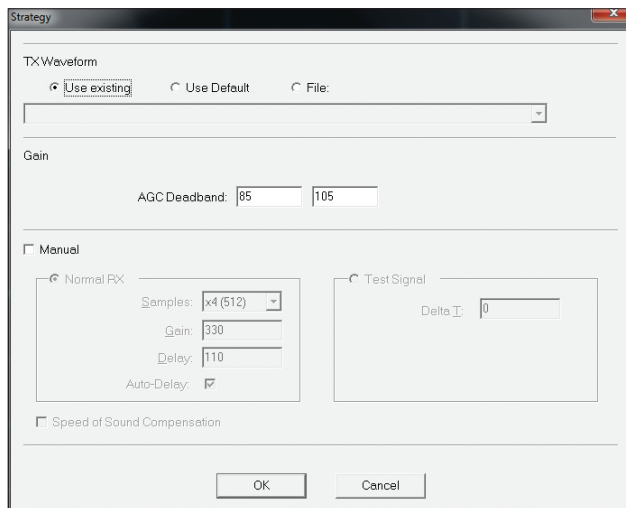

Figure 50: Strategy menu

## CALIBRATION MENU

**C**  
Calibration

The *Calibration* menu contains a powerful multi-point routine for calibrating the transmitter to a primary measuring standard in a particular installation. To initialize the three-step calibration routine, click **Calibration**.

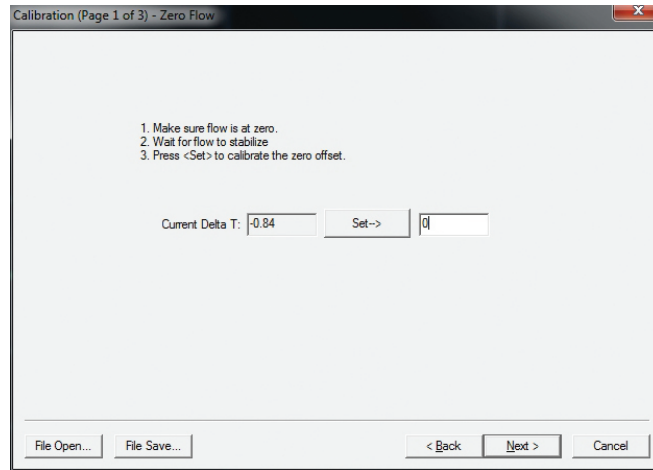

Figure 51: Calibration Page 1 of 3

The first screen, *Page 1 of 3* establishes a baseline zero flow rate measurement for the transmitter.

### Remove the Zero Offset

Because every transmitter installation is slightly different and sound waves can travel in slightly different ways through these installations, it is important to remove the zero offset at zero flow to maintain the transmitter's accuracy. The zeroing process is essential in systems using the DTTS and DTTC transducer sets for accuracy. To establish zero flow and eliminate the offset:

1. Establish zero flow in the pipe (verify that the pipe is full of fluid, turn off all pumps, and close a dead-heading valve). Wait until the delta time interval shown in *Current Delta T* is stable (and typically very close to zero).
2. Click **Set**.
3. Click **Next** when prompted, then click **Finish** to advance to *Page 2 of 3*.

### Select Flow Rate Units

Use *Page 2 of 3* to select the engineering units for the calibration.

1. Select an engineering unit from the *Flow Rate Units* drop-down menu.
2. Click **Next** to advance to *Page 3 of 3*.

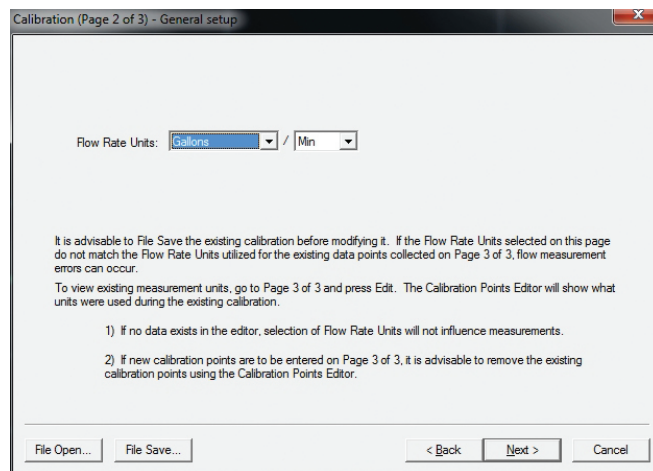

Figure 52: Calibration page 2 of 3



## Set Multiple Flow Rates

Use *Page 3 of 3* to set multiple actual flow rates to be recorded by the transmitter.

To calibrate a point:

1. Establish a stable, known flow rate (verified by a real-time primary flow instrument).
2. Enter the actual flow rate in the *Flow* window and click **Set**.
3. Repeat for as many points as desired.
4. Click **Finish** when you have entered all points.

If you are using only two points (zero and span), use the highest flow rate anticipated in normal operation as the calibration point. If an erroneous data point is collected, remove it (click **Edit**, select the bad point, click **Remove**).

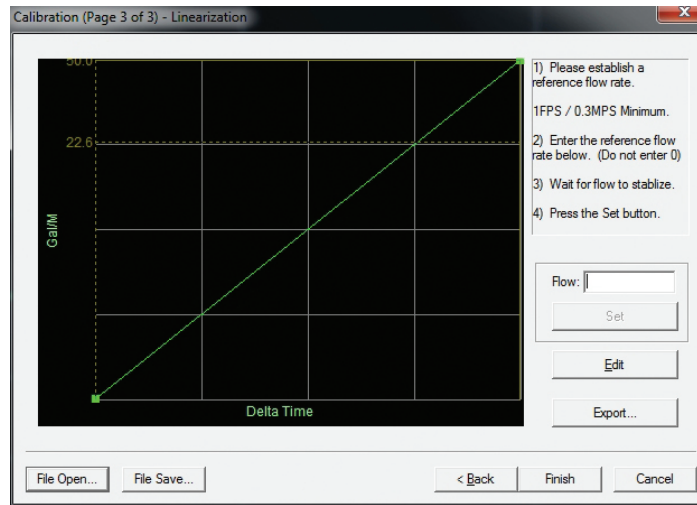

Figure 53: Calibration page 3 of 3

Zero values are not valid for linearization entries. Flow meter zero is entered on *Page 1 of 3*. If a zero calibration point is attempted, the following error message displays:

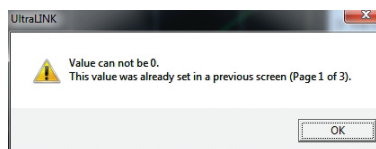

Figure 54: Zero value error

## UltraLink Error Codes

Revised 9-19-2014

	Code	Description	Correction
<b>Warnings</b>	<b>0001</b>	Serial number not present	Hardware serial number has become inoperative – system performance will not be influenced.
	<b>0010</b>	Signal Strength is below Signal Strength Cutoff entry	Low signal strength is typically caused by one of the following: » Empty pipe » Improper programming/incorrect values » Improper transducer spacing » Non-homogeneous pipe wall Removing the resistors from the transducer terminal block can boost the signal.
	<b>0011</b>	Measured speed of sound in the liquid is greater than $\pm 10\%$ of the value entered during transmitter setup	Verify that the correct liquid was selected in the BASIC menu. Verify that pipe size parameters are correct.
	<b>0020</b>	Heat flow is selected and there is no RTD	Verify that you are using an Energy model and that the RTDs are connected.
<b>Class C Errors</b>	<b>1001</b>	System tables have changed	Initiate a transmitter RESET by cycling power or by selecting SYSTEM RESET in the SEC MENU.
	<b>1002</b>	System configuration has changed	Initiate a transmitter RESET by cycling power or by selecting SYSTEM RESET in the SEC MENU.
<b>Class B Errors</b>	<b>3001</b>	Invalid hardware configuration	Upload corrected file.
	<b>3002</b>	Invalid system configuration	Upload corrected file.
	<b>3003</b>	Invalid strategy file	Upload corrected file.
	<b>3004</b>	Invalid calibration data	Re-calibrate the system.
	<b>3005</b>	Invalid speed-of-sound calibration data	Upload new data.
	<b>3006</b>	Bad system tables	Upload new table data.
<b>Class A Errors</b>	<b>4001</b>	Flash memory full	Return transmitter to factory for evaluation

Table 10: Error codes

## Target Dbg Data Screen Definitions

Field	Description
Device Type	Auto-filled.
Calc Count	The number of flow calculations performed by the transmitter beginning at the time the power to the transmitter was last turned off and then on again.
Sample Count	The number of samples currently being taken in one second.
Raw Delta T (ns)	The actual amount of time it takes for an ultrasonic pulse to cross the pipe.
Course Delta T	The transmitter series that uses two wave forms. The coarse to find the best delay and other timing measurements and a fine to do the flow measurement.
Gain	The amount of signal amplification applied to the reflected ultrasound pulse to make it readable by the digital signal processor.
Gain Setting/ Waveform Power	The first number The gain setting on the digital pot (automatically controlled by the AGC circuit). Valid numbers are from 1...100. The second number The power factor of the current waveform being used. For example, 8 indicates that a 1/8 power wave form is being used.
Tx Delay	The amount of time the transmitting transducer waits for the receiving transducer to recognize an ultrasound signal before the transmitter initiates another measurement cycle.
Flow Filter	The current value of the adaptive filter.
SS (Min/Max)	The minimum and maximum signal strength levels encountered by the transmitter beginning at the time the power to the transmitter was last turned off and then on again.
Signal Strength State	indicates if the present signal strength minimum and maximum are within a pre-programmed signal strength window.
Sound Speed	The actual sound speed being measured by the transducers at that moment.
Reynolds	is a number indicating how turbulent a fluid is. Reynolds numbers between 0 and 2000 are considered laminar flow. Numbers between 2000...4000 are in transition between laminar and turbulent flows and numbers greater than 4000 indicate turbulent flow.
Reynolds Factor	The value applied to the flow calculation to correct for variations in Reynolds numbers.

The screenshot shows a window titled "Target Dbg Data" with the following fields and values:

- Device Type: TFX Ultra
- Calc Count: 1049 (with a secondary value of 2.3 CPS)
- Raw DeltaT(ns): -0.39 (with a secondary value of 0)
- Gain: 393 (with a secondary value of 53)
- Tx Delay: 43.8
- Flow Filter: 80
- SS (Min/Max): 22.8/23.3 % (with an OK button)
- Sound Speed: 6242.60
- Reynolds: 4 (with a secondary value of 0.7500)
- Reset button

Figure 55: Target Dbg data screen

## Saving the Configuration on a PC

The complete configuration of the transmitter can be saved from the Configuration screen. Select **File Save** button located in the lower left-hand corner of the screen and name the file. Files are saved as a \*.dcf extension. This file may be transferred to other transmitters or may be recalled should the same pipe be surveyed again or multiple transmitters programmed with the same information.

## Printing a Configuration Report

Select **File > Print** to print a calibration/configuration information sheet for the installation.

# MENU MAPS

## Basic Menu

<b>UNITS</b> <small>Programming Units</small> English Metric	<b>PIPE WT</b> <small>Pipe Wall Thickness</small> English (Inches) Metric (mm)	<b>LINER MA</b> <small>Pipe Liner Material</small> Ebonite Mortar HDPE LDPE Polypropylene Polystyrene Rubber Tar Epoxy Teflon PFA Other	<b>FLUID SS</b> <small>Fluid Sound Speed</small> English (FPS) Metric (MPS)	<b>RATE INT</b> <small>Rate Interval</small> Sec Min Hour Day	<b>MIN RATE</b> <small>Minimum Flow Rate</small> Numeric Entry
<b>ADDRESS</b> <small>Multi-Drop Device Address</small> Numeric Entry (1 ... 126)	<b>PIPE MAT</b> <small>Pipe Material</small> Acrylic Aluminum Brass (Naval) Carbon Steel Cast Iron Copper Ductile Iron Fiberglass-Epoxy Glass Pyrex Nylon HD Polyethylene LD Polyethylene Polypropylene PVC CPVC PVDF St Steel 302/303 St Steel 304/316 St Steel 410 St Steel 430 PFA Titanium Asbestos Other	<b>LINER SS</b> <small>Pipe Liner Sound Speed</small> English (FPS) Metric (MPS)	<b>FLUID VI</b> <small>Fluid Viscosity</small> CPS	<b>TOTL UNT</b> <small>Total Units</small> Gallons Liters MGal Cubic Ft Cubic Me Acre Ft Oil Barr (42 Gal) Liq Barr (31.5 Gal) Feet Meters LB KG <sup>1</sup> BTU <sup>1</sup> MBTU <sup>1</sup> MMBTU <sup>1</sup> TONHR <sup>1</sup> kJ <sup>1</sup> kWH <sup>1</sup> MWH	<b>MAX RATE</b> <small>Maximum Flow Rate</small> Numeric Entry
<b>BAUD</b> <small>Baud Rate of RS485</small> 9600 14400 19200 38400 56000 57600 76800	<b>PIPE SS</b> <small>Pipe Sound Speed</small> English (FPS) Metric (MPS)	<b>LINER R</b> <small>Liner Roughness</small> Numeric Entry	<b>SP GRVTY</b> <small>Specific Gravity</small> Numeric Entry	<b>DAMP PER</b> <small>Damping Percentage</small> Numeric Entry	
<b>BACNET ID</b> <small>BACnet Device ID Value</small> 0 ... 4194303	<b>FL TYPE</b> <small>Fluid Type</small> Water Tap Sewage Acetone Alcohol Ammonia Benzene Brine Ethanol Ethylene Glycol Gasoline Glycerin Isopropyl Alcohol Kerosene Methanol Oil Hydraulic (petro-base) Oil Lubricating Oil Motor (SAE 20/30) Water Distilled Water Sea Other	<b>SP HEAT</b> <small>Nominal Heat Capacity</small> Numeric Entry	<b>XDC SPAC</b> <small>Transducer Spacing</small> English (Inches) Metric (mm) Note: This value is calculated by firmware.	<b>TOTL E</b> <small>Totalizer Exponent</small> E-1 (-10) E0 (X1) E1 (X10) E2 (X100) E3 (X1,000) E4 (X10,000) E5 (X100,000) E6 (X1,000,000)	
<b>XDCR MNT</b> <small>Transducer Mounting</small> V W Z	<b>PIPE R</b> <small>Relative Roughness</small> Numeric Entry	<b>RATE UNT</b> <small>Rate Units</small> Gallons Liters MGal Cubic Ft Cubic Me Acre Ft Oil Barr (42 Gal) Liq Barr (31.5 Gal) Feet Meters LB KG <sup>1</sup> BTU <sup>1</sup> MBTU <sup>1</sup> MMBTU <sup>1</sup> TONHR <sup>1</sup> kJ <sup>1</sup> kWH <sup>1</sup> MWH			
<b>XDCR HZ</b> <small>Transducer Frequency</small> 1 MHz 2 MHz 500 kHz	<b>LINER T</b> <small>Pipe Liner Thickness</small> English (Inches) Metric (mm)				
<b>FLOW DIR</b> <small>Flow Direction</small> Forward Reverse					
<b>PIPE OD</b> <small>Pipe Outside Diameter</small> English (Inches) Metric (mm)					

<sup>1</sup> The heat flow measurements only appear when RTD is chosen in the Output 2 menu.

## Channel 1 Menu

<b>4-20MA</b> <small>4-20 mA Setup</small> FL 4MA FL 20MA CAL 4MA CAL 20MA 4-20 TST
---

## Channel 2 Menu

- The Channel 2 menu allows the configuration of meter-specific I/O parameters.
- RTD values are specific to a particular RTD.
- The menu structure and programming are identical for both Control 1 and Control 2, but the choice of function for a specific control output is independent of the other.

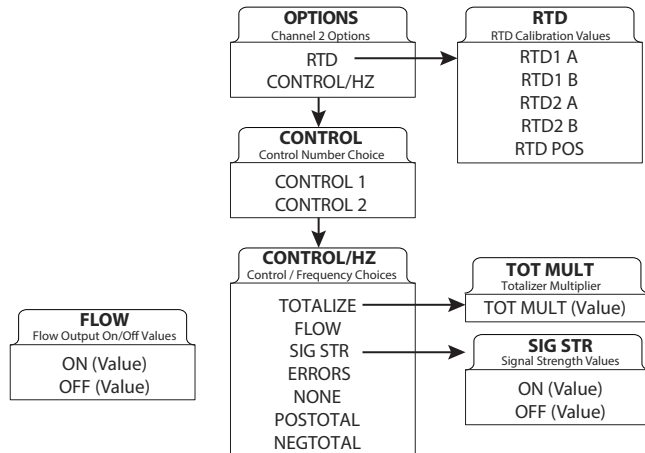

## Sensor Menu

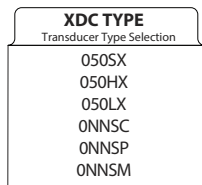

## Security Menu

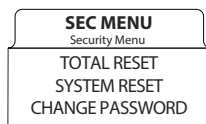

## Service Menu

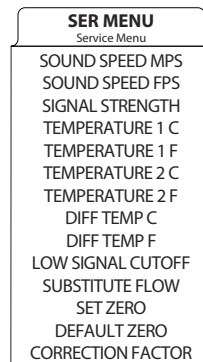

## Display Menu

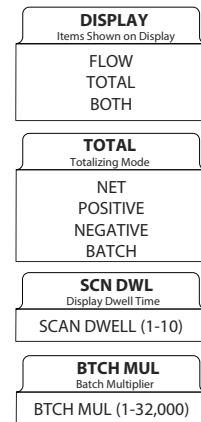

## COMMUNICATIONS PROTOCOLS

### Non-Ethernet Module Models

The following three parameters can be set through the TFX menu or the UltraLink software utility:

- Modbus RTU
  - Address: = Meter Address / Modbus Address
  - Baud Rate: = Baud Rate Selection (9600, 14400, 19200, 38400, 56000, 57600, 76800)
  - BACnet ID: = Not Used (Value does not affect Modbus in any way)
- BACnet MSTP
  - Address: = Meter Address / BACnet MAC Address
  - Baud Rate: = Baud Rate Selection (9600, 14400, 19200, 38400, 56000, 57600, 76800)
  - BACnet ID: = BACnet Device ID

### Ethernet Module Models

The Ethernet communication parameters are set through the internal web pages of the Ethernet module, not through the TFX menu or the UltraLink software utility. See *“Ethernet Port Settings”* on page 83 for details.

- Modbus TCP/IP
  - Address: = IP Address
  - Baud Rate: = Does not exist for Modbus TCP/IP. Com speed = Ethernet Link Speed.
  - BACnet ID: = Not Used (Value does not affect Modbus TCP/IP in any way)
- BACnet IP
  - Address: = IP Address
  - Baud Rate = Does not exist for BACnet IP. Com speed = Ethernet Link Speed.
  - BACnet ID: = BACnet Device ID
- Ethernet IP
  - Address: = IP Address
  - Baud Rate: = Does not exist for Ethernet IP. Com speed = Ethernet Link Speed.
  - BACnet ID: = Not Used (Value does not affect Ethernet IP in any way)

## EtherNet/IP

### Overview

EtherNet/IP is an open industrial Ethernet network with Common Industrial Protocol (CIP™) at its upper layers. ODVA manages the development of CIP network technologies and standards ([www.odva.org](http://www.odva.org)).

#### EtherNet/IP Addressing

The following table describes all of the data types used.

USINT	Unsigned Short Integer (8-bit)
UINT	Unsigned Integer (16-bit)
UDINT	Unsigned Double Integer (32-bit)
INT	Signed Integer (16-bit)
DINT	Signed Integer (32-bit)
STRING	Character String (1 byte per character)
SHORT STRINGNN	Character String (1st byte is length; up to NN characters)
BYTE	Bit String (8-bits)
WORD	Bit String (16-bits)
DWORD	Bit String (32-bits)
REAL	IEEE 32-bit Single Precision Floating Point

Table 11: Data types

### Identity Object (01<sub>HEX</sub> – 1 Instance)

The following tables contain the attribute, status, and common services information for the Identity Object.

#### Class Attributes (Instance 0)

Attribute ID	Name	Data Type	Data Value	Access Rule
1	Revision	UINT	1	Get

#### Instance Attributes (Instance 1)

Attribute ID	Name	Data Type	Data Value	Access Rule
1	Vendor Number	UINT	1126	Get
2	Device Type	UINT	00 <sub>HEX</sub>	Get
3	Product Code Number	UINT	1	Get
4	Product Major Revision Product Minor Revision	USINT USINT	01 01	Get
5	Status	WORD	See Below	Get
6	Serial Number	UDINT	TFX	Get
7	Product Name	SHORT STRING32	TFX	Get
16	User Configurable Product Description Name	SHORT STRING32	TFX	Get/Set

Common Services

Service Code	Implemented for		Service Name
	Class Level	Instance Level	
05 <sub>HEX</sub>	No	Yes	Reset
0E <sub>HEX</sub>	Yes	Yes	Get_Attribute_Single
10 <sub>HEX</sub>	No	Yes	Set_Attribute_Single

**Message Router Object (02<sub>HEX</sub> – 1 Instance)**

\*\*\*No supported services or attributes\*\*\*

**Assembly Object (04HEX – 2 Instances)**

*Class Attributes (Instance 0)*

Attribute ID	Name	Data Type	Data Value	Access Rule
1	Revision	UINT	2	Get
2	Max Instance	UINT	101	Get

*Input Instance Attributes (Instance 100)*

Attribute ID	Name	Data Type	Default Data Value	Access Rule
3	Input Data	USINT[56]	0	Get

*Input Instance 100 – 100 Bytes (Single Precision Floating Point)*

Bytes	Description
0 - 3	Signal Strength
4 - 7	Flow Rate
8 - 11	Net Totalizer
12 - 15	Positive Totalizer
16 - 19	Negative Totalizer
20 - 23	Temp1 degC
24 - 27	Temp2 degC
28 - 31	Diff Temp(1-2) degC
32 - 35	Diff Temp(2-1) degC
36 - 39	Abs Diff Temp degC
40 - 43	Temp1 degF
44 - 47	Temp2 degF
48 - 51	Diff Temp(1-2) degF
52 - 55	Diff Temp(2-1) degF
56 - 59	Abs Diff Temp degF
60 - 63	Flow Rate GPM
64 - 67	Flow Rate LPM
68 - 71	Flow Rate CFH
72 - 75	Flow Rate CMH
76 - 79	Flow Rate FPS
80 - 83	Flow Rate MPS
84 - 87	Flow Unit Code
88 - 91	Total Unit Code
92 - 95	Total Exponent Unit Code
96 - 99	Time Unit Code



*Input Instance 101 – 200 Bytes (Double Precision Floating Point)*

<b>Bytes</b>	<b>Description</b>
0 - 7	Signal Strength
8 - 15	Flow Rate
16 - 23	Net Totalizer
24 - 31	Positive Totalizer
32 - 39	Negative Totalizer
40 - 47	Temp1 degC
48 - 55	Temp2 degC
56 - 63	Diff Temp(1-2) degC
64 - 71	Diff Temp(2-1) degC
72 - 79	Abs Diff Temp degC
80 - 87	Temp1 degF
88 - 95	Temp2 degF
96 - 103	Diff Temp(1-2) degF
104 - 111	Diff Temp(2-1) degF
112 - 119	Abs Diff Temp degF
120 - 127	Flow Rate GPM
128 - 135	Flow Rate LPM
136 - 143	Flow Rate CFH
144 - 151	Flow Rate CMH
152 - 159	Flow Rate FPS
160 - 167	Flow Rate MPS
168 - 175	Flow Unit Code
176 - 183	Total Unit Code
184 - 191	Total Exponent Unit Code
192 - 199	Time Unit Code

**Input Instance Common Services**

<b>Service Code</b>	<b>Implemented for</b>		<b>Service Name</b>
	<b>Class Level</b>	<b>Instance Level</b>	
0E <sub>HEX</sub>	Yes	Yes	Get_Attribute_Single

**Connection Manager Object (06<sub>HEX</sub>)**

\*\*\*No supported services or attributes\*\*\*

## TCP Object (F5<sub>HEX</sub> – 1 Instance)

The following tables contain the attribute and common services information for the TCP Object.

### Class Attributes

Attribute ID	Name	Data Type	Data Value	Access Rule
1	Revision	UINT	2	Get

### Instance Attributes

Attribute ID	Name	Data Type	Default Data Value	Access Rule
1	Status <sup>1</sup>	DWORD	1	Get
2	Configuration Capability <sup>2</sup>	DWORD	0	Get
3	Configuration Control <sup>3</sup>	DWORD	0	Get
4	Physical Link Object <sup>4</sup> <b>Structure of:</b> Path Size Path	UINT Array Of WORD	2 0x20F6 0x2401	Get
5	Interface Configuration <sup>5</sup> <b>Structure of:</b> IP Address Network Mask Gateway Address Name Server Name Server 2 Domain Name Size Domain Name	UDINT UDINT UDINT UDINT UDINT UINT STRING	0 0 0 0 0 0 0	Get
6	Host Name <sup>6</sup> <b>Structure of:</b> Host Name Size Host Name	UINT STRING	0 0	Get

### Common Services

Service Code	Implemented for		Instance Level
	Class Level	Instance Level	
0E <sub>HEX</sub>	Yes	Yes	Get_Attribute_Single

<sup>1</sup> See section 5-3.2.2.1 of "Volume 2: EtherNet/IP Adaptation of CIP" from ODVA for more details on this attribute.

<sup>2</sup> See section 5-3.2.2.2 of "Volume 2: EtherNet/IP Adaptation of CIP" from ODVA for more details on this attribute.

<sup>3</sup> See section 5-3.2.2.3 of "Volume 2: EtherNet/IP Adaptation of CIP" from ODVA for more details on this attribute.

<sup>4</sup> See section 5-3.2.2.4 of "Volume 2: EtherNet/IP Adaptation of CIP" from ODVA for more details on this attribute.

<sup>5</sup> See section 5-3.2.2.5 of "Volume 2: EtherNet/IP Adaptation of CIP" from ODVA for more details on this attribute.

<sup>6</sup> See section 5-3.2.2.6 of "Volume 2: EtherNet/IP Adaptation of CIP" from ODVA for more details on this attribute.

## Ethernet Link Object (F6<sub>HEX</sub> – 1 Instance)

The following tables contain the attribute and common services information for the Ethernet Link Object.

### Class Attributes

Attribute ID	Name	Data Type	Data Value	Access Rule
1	Revision	UINT	3	Get

### Instance Attributes

Attribute ID	Name	Data Type	Default Data Value	Access Rule
1	Interface Speed <sup>7</sup>	UDINT	100	Get
2	Interface Flags <sup>8</sup>	DWORD	3	Get
3	Physical Address <sup>9</sup>	USINT Array[6]	0	Get

### Common Services

Service Code	Implemented for		Service Name
	Class Level	Instance Level	
0E <sub>HEX</sub>	Yes	Yes	Get_Attribute_Single

<sup>7</sup> See section 5-4.2.2.1 of "Volume 2: EtherNet/IP Adaptation of CIP" from ODVA for more details on this attribute.

<sup>8</sup> See section 5-4.2.2.2 of "Volume 2: EtherNet/IP Adaptation of CIP" from ODVA for more details on this attribute.

<sup>9</sup> See section 5-4.2.2.3 of "Volume 2: EtherNet/IP Adaptation of CIP" from ODVA for more details on this attribute.

## Reset Totalizer Object (65<sub>HEX</sub> - 1 Instance)

### Class Attributes (Instance 0)

Attribute ID	Name	Data Type	Data Value	Access Rule
1	Revision	UINT	1	Get

### Instance Attributes (Instance 1)

Attribute ID	Name	Data Type	Default Data Value	Access Rule
1	Reset Totalizers	BOOL	*Write "1" to reset *Will always read "0"	Get/Set

### Common Services

Service Code	Implemented for		Service Name
	Class Level	Instance Level	
0E <sub>HEX</sub>	Yes	Yes	Get_Attribute_Single
10 <sub>HEX</sub>	No	Yes	Set_Attribute_Single

## Modbus

Data Formats			
	Bits	Bytes	Modbus Registers
Long Integer	32	4	2
Single Precision IEEE754	32	4	2
Double Precision IEEE754	64	8	4

Table 12: Available data formats

### Modbus Register / Word Ordering

Each Modbus Holding Register represents a 16-bit integer value (2 bytes). The official Modbus standard defines Modbus as a 'big-endian' protocol where the most significant byte of a 16-bit value is sent before the least significant byte. For example, the 16-bit hex value of '1234' is transferred as '12'34'.

Beyond 16-bit values, the protocol itself does not specify how 32-bit (or larger) numbers that span over multiple registers should be handled. It is very common to transfer 32-bit values as pairs of two consecutive 16-bit registers in little-endian word order. For example, the 32-bit hex value of '12345678' is transferred as '56'78'12'34'. Notice the Register Bytes are still sent in big-endian order per the Modbus protocol, but the Registers are sent in little-endian order.

Other manufacturers, store and transfer the Modbus Registers in big-endian word order. For example, the 32-bit hex value of '12345678' is transferred as '12'34'56'78'. It does not matter in which order the words are sent, as long as the receiving device knows which way to expect it. Since it is a common problem between devices regarding word order, many Modbus master devices have a configuration setting for interpreting data (over multiple registers) as 'little-endian' or 'big-endian' word order. This is also referred to as swapped or word-swapped values and allows the master device to work with slave devices from different manufacturers.

If, however, the endianness is not a configurable option within the Modbus master device, it is important to make sure it matches the slave endianness for proper data interpretation. The transmitter actually provides two Modbus Register maps to accommodate both formats. This is useful in applications where the Modbus Master cannot be configured for endianness.

Communication Settings	
Baud Rate	9600
Parity	None
Data Bits	8
Stop Bits	1
Handshaking	None

Table 13: Communications settings

**Modbus Register Mappings for Modbus RTU and Modbus TCP/IP**

Data Component Name	MODBUS Registers			Units	
	Long Integer Format	Single Precision Floating Point Format	Double Precision Floating Point Format		
Signal Strength	40100 - 40101	40200 - 40201	40300 - 40303	—	
Flow Rate	40102 - 40103	40202 - 40203	40304 - 40307	Gallons, Liters, MGallons, Cubic Feet, Cubic Meters, Acre Feet, Oil Barrel, Liquid Barrel, Feet, Meters, Lb, Kg, BTU, MBTU, MMBTU, TON <b>Per</b> Second, Minute, Hour, Day	
Net Totalizer	40104 - 40105	40204 - 40205	40308 - 40311		
Positive Totalizer	40106 - 40107	40206 - 40207	40312 - 40315		
Negative Totalizer	40108 - 40109	40208 - 40209	40316 - 40319		
Temperature 1	40110 - 40111	40210 - 40211	40320 - 40323	°C	
Temperature 2	40112 - 40113	40212 - 40213	40324 - 40327	°C	
Diff Temp (1-2)	40114 - 40115	40214 - 40215	40328 - 40331	°C	
Diff Temp (2-1)	40116 - 40117	40216 - 40217	40332 - 40335	°C	
Abs Diff Temp	40118 - 40119	40218 - 40219	40336 - 40339	°C	
Temperature 1	40120 - 40121	40220 - 40221	40340 - 40343	°F	
Temperature 2	40122 - 40123	40222 - 40223	40344 - 40347	°F	
Diff Temp (1-2)	40124 - 40125	40224 - 40225	40348 - 40351	°F	
Diff Temp (2-1)	40126 - 40127	40226 - 40227	40352 - 40355	°F	
Abs Diff Temp	40128 - 40129	40228 - 40229	40356 - 40359	°F	
Flow Rate	40130 - 40131	40230 - 40231	40360 - 40363	GPM	
Flow Rate	40132 - 40133	40232 - 40233	40364 - 40367	LPM	
Flow Rate	40134 - 40135	40234 - 40235	40368 - 40371	CFH	
Flow Rate	40136 - 40137	40236 - 40237	40372 - 40375	CMH	
Flow Rate	40138 - 40139	40238 - 40239	40376 - 40379	FPS	
Flow Rate	40140 - 40141	40240 - 40241	40380 - 40383	MPS	
<b>Flow</b> Unit Code	40142 - 40143	40242 - 40243	40384 - 40387	1 = Gallons 2 = Liters 3 = MGallons 4 = Cubic Feet 5 = Cubic Meter 6 = Acre Feet 7 = Oil Barrel 8 = Liq Barrel 9 = Feet 10 = Meters	11 = LB 12 = Kg 13 = BTU 14 = MBTU 15 = MMBTU 16 = Ton 17 = KJ 18 = kWh 19 = MWh
<b>Total</b> Unit Code	40144 - 40145	40244 - 40245	40388 - 40391		
<b>Total Exponent</b> Unit Code	40146 - 40147	40246 - 40247	40392 - 40395	1 = E-1 2 = E0 3 = E1 4 = E2	5 = E3 6 = E4 7 = E5 8 = E6
<b>Time</b> Unit Code	40148 - 40149	40248 - 40249	40396 - 40399	1 = Second 2 = Minute 3 = Hour 4 = Day	5 = msec 6 = usec 7 = nsec 8 = psec

Table 14: Modbus register map for 'Little-endian' word order master devices

For reference: If the transmitters Net Totalizer = 12345678 hex

Register 40102 would contain 5678 hex (Word Low)

Register 40103 would contain 1234 hex (Word High)

Data Component Name	MODBUS Registers			Units	
	Long Integer Format	Single Precision Floating Point Format	Double Precision Floating Point Format		
Signal Strength	40600 - 40601	40700 - 40701	40800 - 40803	—	
Flow Rate	40602 - 40603	40702 - 40703	40804 - 40807	Gallons, Liters, MGallons, Cubic Feet, Cubic Meters, Acre Feet, Oil Barrel, Liquid Barrel, Feet, Meters, Lb, Kg, BTU, MBTU, MMBTU, TON <b>Per</b> Second, Minute, Hour, Day	
Net Totalizer	40604 - 40605	40704 - 40705	40808 - 40811		
Positive Totalizer	40606 - 40607	40706 - 40707	40812 - 40815		
Negative Totalizer	40608 - 40609	40708 - 40709	40816 - 40819		
Temperature 1	40610 - 40611	40710 - 40711	40820 - 40823		
Temperature 2	40612 - 40613	40712 - 40713	40824 - 40827	°C	
Diff Temp (1-2)	40614 - 40615	40714 - 40715	40828 - 40831	°C	
Diff Temp (2-1)	40616 - 40617	40716 - 40717	40832 - 40835	°C	
Abs Diff Temp	40618 - 40619	40718 - 40719	40836 - 40839	°C	
Temperature 1	40620 - 40621	40720 - 40721	40840 - 40843	°F	
Temperature 2	40622 - 40623	40722 - 40723	40844 - 40847	°F	
Diff Temp (1-2)	40624 - 40625	40724 - 40725	40848 - 40851	°F	
Diff Temp (2-1)	40626 - 40627	40726 - 40727	40852 - 40855	°F	
Abs Diff Temp	40628 - 40629	40728 - 40729	40856 - 40859	°F	
Flow Rate	40630 - 40631	40730 - 40731	40860 - 40863	GPM	
Flow Rate	40632 - 40633	40732 - 40733	40864 - 40867	LPM	
Flow Rate	40634 - 40635	40734 - 40735	40868 - 40871	CFH	
Flow Rate	40636 - 40637	40736 - 40737	40872 - 40875	CMH	
Flow Rate	40638 - 40639	40738 - 40739	40876 - 40879	FPS	
Flow Rate	40640 - 40641	40740 - 40741	40880 - 40883	MPS	
<b>Flow</b> Unit Code	40642 - 40643	40742 - 40743	40884 - 40887	1 = Gallons 2 = Liters 3 = MGallons 4 = Cubic Feet 5 = Cubic Meter 6 = Acre Feet 7 = Oil Barrel 8 = Liq Barrel 9 = Feet 10 = Meters	11 = LB 12 = Kg 13 = BTU 14 = MBTU 15 = MMBTU 16 = Ton 17 = KJ 18 = kWh 19 = MWh
<b>Total</b> Unit Code	40644 - 40645	40744 - 40745	40888 - 40891		
<b>Total Exponent</b> Unit Code	40646 - 40647	40746 - 40747	40892 - 40895	1 = E-1 2 = E0 3 = E1 4 = E2	5 = E3 6 = E4 7 = E5 8 = E6
<b>Time</b> Unit Code	40648 - 40649	40748 - 40749	40896 - 40899	1 = Second 2 = Minute 3 = Hour 4 = Day	5 = msec 6 = usec 7 = nsec 8 = psec

Table 15: Modbus register map for 'Big-endian' word order master devices

For reference: If the transmitters Net Totalizer = 12345678 hex

Register 40602 would contain 1234 hex (Word High)

Register 40603 would contain 5678 hex (Word Low)

Modbus Coil Description	Modbus Coil	Notes
Reset Totalizers	1	Forcing this coil on will reset all totalizers. After reset, the coil automatically returns to the off state.

Table 16: Modbus coil map

## BACnet

BACnet is a communication protocol for building automation and control networks, including BACnet/IP with Ethernet cabling and BACnet MS/TP with EIA-485 wiring. The protocol is supported and maintained by ASHRAE Standing Standard Project Committee 135.

### BACnet IP Object Mappings

Object Description	BACnet Object (Access Point)	Notes	Available Units	
Signal Strength	AI1	Analog Input 1	—	
Flow Rate (Flow model) Energy Rate (BTU model)	AI2	Analog Input 2	Gallons, Liters, MGallons, Cubic Feet, Cubic Meters, Acre Feet, Oil Barrel, Liquid Barrel, Feet, Meters, Lb, Kg, BTU, MBTU, MMBTU, TON <b>Per</b> Second, Minute, Hour, Day	
Net Totalizer	AI3	Analog Input 3		
Positive Totalizer	AI4	Analog Input 4		
Negative Totalizer	AI5	Analog Input 5		
Temperature 1	AI6	Analog Input 6		
Temperature 2	AI7	Analog Input 7	°C	
Diff Temp (1-2)	AI8	Analog Input 8	°C	
Diff Temp (2-1)	AI9	Analog Input 9	°C	
Abs Diff Temp	AI10	Analog Input 10	°C	
Temperature 1	AI11	Analog Input 11	°F	
Temperature 2	AI12	Analog Input 12	°F	
Diff Temp (1-2)	AI13	Analog Input 13	°F	
Diff Temp (2-1)	AI14	Analog Input 14	°F	
Abs Diff Temp	AI15	Analog Input 15	°F	
Flow Rate	AI16	Analog Input 16	GPM	
Flow Rate	AI17	Analog Input 17	LPM	
Flow Rate	AI18	Analog Input 18	CFH	
Flow Rate	AI19	Analog Input 19	CMH	
Flow Rate	AI20	Analog Input 20	FPS	
Flow Rate	AI21	Analog Input 21	MPS	
<b>Flow</b> Unit Code	AI22	Analog Input 22	1 = Gallons 2 = Liters 3 = MGallons 4 = Cubic Feet 5 = Cubic Meter 6 = Acre Feet 7 = Oil Barrel 8 = Liq Barrel 9 = Feet 10 = Meters	11 = LB 12 = Kg 13 = BTU 14 = MBTU 15 = MMBTU 16 = Ton 17 = KJ 18 = kWh 19 = MWh
<b>Total</b> Unit Code	AI23	Analog Input 23		
<b>Total Exponent</b> Unit Code	AI24	Analog Input 24	1 = E-1 2 = E0 3 = E1 4 = E2	5 = E3 6 = E4 7 = E5 8 = E6
<b>Time</b> Unit Code	AI25	Analog Input 25	1 = Second 2 = Minute 3 = Hour 4 = Day	5 = msec 6 = usec 7 = nsec 8 = psec
Reset Totalizers	BO1	Binary Output 1  Writing a (1) active state to this object will reset all totalizers. The Object will then automatically return to the (0) inactive state.	—	

Table 17: BACnet IP object mappings

**BACnet MSTP Object Mappings**

Object Description	BACnet Object (Access Point)	Notes	Available Units
Signal Strength	AI1	Analog Input 1	—
Flow Rate (Flow model) Energy Rate (BTU model)	AI2	Analog Input 2	Gallons, Liters, MGallons, Cubic Feet, Cubic Meters, Acre Feet, Oil Barrel, Liquid Barrel, Feet, Meters, Lb, Kg, BTU, MBTU, MMBTU, TON <b>Per</b> Second, Minute, Hour, Day
Net Totalizer	AI3	Analog Input 3	
Positive Totalizer	AI4	Analog Input 4	
Negative Totalizer	AI5	Analog Input 5	
Temperature 1	AI6	Analog Input 6	
Temperature 2	AI7	Analog Input 7	°C
Temperature 1	AI11	Analog Input 11	°F
Temperature 2	AI12	Analog Input 12	°F
Flow Rate	AI16	Analog Input 16	GPM
Flow Rate	AI17	Analog Input 17	LPM
Reset Totalizers	BO1	Binary Output 1  Writing a (1) active state to this object will reset all totalizers. The Object will then automatically return to the (0) inactive state.	—

Table 18: BACnet MSTP object mappings



## BACnet Configuration

To change settings, click **Edit** to access a category.



Figure 56: BACnet configuration screen

## BACnet Object Support

Twenty-seven BACnet standard objects are supported, a Device object (DEx), a Binary Output object (BO1), and twenty-five Analog Input objects (AI1 through A25). The BACnet/IP UDP port defaults to 0xBAC0. The Object Identifier (BACnet Device ID) and Location can both be modified through the web page interface.

DEx	Object_Identifier	Defaults to DEx Can modify "x" through web page (1-9999)	
	Object_Name	Up to 32 characters	W
	Object_Type	DEVICE (8)	R
	System_Status	OPERATIONAL or NON_OPERATIONAL	R
	Vendor_Name	"Badger Meter, Inc."	R
	Vendor_Identifier	306	R
	Model_Name	"TFX"	R
	Application_Software_Version	"1.24"	R
	Location	"Sample Device Location" Up to 64 characters - can modify through web page	W
	Protocol_Version	1	R
	Protocol_Revision	2	R
	Protocol_Services_Supported	{ readProperty, writeProperty, readPropertyMultiple, writePropertyMultiple, deviceCommunicationControl, who-Has, who-Is }	R
	Protocol_Object_Types_Supported	{ AnalogInput, BinaryOutput, Device }	R
	Object_List	DEx, AI1, AI2, AI3, AI4, AI5, AI6, AI7, AI8, AI9, AI10, AI11, AI12, AI13, AI14, AI15, AI16, AI17, AI18, AI19, AI	R
		BO1	W
	Max_APDU_Length_Accepted	1476	R
	Segmentation_Supported	3 – NONE	R
	APDU_Timeout	3000 default	R
	Number_Of_APDU_Retries	1 default	R
	Device_Address_Binding	always empty	R
	Database_Revision	0	R

Table 19: BACnet standard objects

---

## Annex A—Protocol Implementation Conformance Statement (Normative)

### BACnet Protocol Implementation Conformance Statement

**Date:** 05/30/2014  
**Vendor Name:** Badger Meter, Inc.  
**Product Name:** TFX Ultra Flow meter  
**Product Model Number:** TFX  
**Application Software Version:** 2.03  
**Firmware Revision:** N/A  
**BACnet Protocol Revision:** 10

#### Product Description:

Clamp-on ultrasonic flow and energy meters for liquids

#### BACnet Standardized Device Profile (Annex L):

- BACnet Operator Workstation (B-OWS)
- BACnet Building Controller (B-BC)
- BACnet Advanced Application Controller (B-AAC)
- BACnet Application Specific Controller (B-ASC)
- BACnet Smart Sensor (B-SS)
- BACnet Smart Actuator (B-SA)

#### List all BACnet Interoperability Building Blocks Supported (Annex K):

- Data Sharing-ReadProperty-B (DS-RP-B)
- Data Sharing-WriteProperty-B (DS-WP-B)
- Data Sharing - ReadProperty Multiple - B (DS-RPM-B)
- Data Sharing - WriteProperty Multiple - B (DS-WPM-B)
- Device Management-Dynamic Device Binding-B (DM-DDB-B)
- Device Management-Dynamic Object Binding-B (DM-DOB-B)
- Device Management-DeviceCommunicationControl-B (DM-DCC-B)

#### Segmentation Capability:

- Segmented requests supported Window Size \_\_\_\_\_
- Segmented responses supported Window Size \_\_\_\_\_

#### Standard Object Types Supported:

- 1 Device Object
- 11 Analog Input Objects
- 1 Binary Output Object

**Data Link Layer Options:**

- BACnet IP, (Annex J)
- BACnet IP, (Annex J), Foreign Device
- ISO 8802-3, Ethernet (Clause 7)
- ANSI/ATA 878.1, 2.5 Mb. ARCNET (Clause 8)
- ANSI/ATA 878.1, RS-485 ARCNET (Clause 8), baud rate(s): \_\_\_\_\_
- MS/TP master (Clause 9), baud rate(s): 9600, 19200, 38400, 76800
- MS/TP slave (Clause 9), baud rate(s): \_\_\_\_\_
- Point-To-Point, EIA 232 (Clause 10), baud rate(s): \_\_\_\_\_
- Point-To-Point, modem, (Clause 10), baud rate(s): \_\_\_\_\_
- LonTalk, (Clause 11), medium: \_\_\_\_\_
- Other: \_\_\_\_\_

**Device Address Binding:**

Is static device binding supported? (This is currently necessary for two-way communication with MS/TP slaves and certain other devices.)  Yes  No

**Networking Options:**

- Router, Clause 6 - List all routing configurations, e.g., ARCNET-Ethernet, Ethernet-MS/TP, etc.
- Annex H, BACnet Tunneling Router over IP
- BACnet/IP Broadcast Management Device (BBMD)  
Does the BBMD support registrations by Foreign Devices?  Yes  No

**Character Sets Supported:**

Indicating support for multiple character sets does not imply that they can all be supported simultaneously.

- ANSI X3.4  IBM /Microsoft  DBCS  ISO 8859-1
- ISO 10646 (UCS-2)  ISO 10646 (UCS-4)  JIS C 6226

**If this product is a communication gateway, describe the types of non-BACnet equipment/networks(s) that the gateway supports:**

Not supported

## Annex A—Protocol Implementation Conformance Statement (Normative)

(This annex is part of this Standard and is required for its use.)

### BACnet Protocol Implementation Conformance Statement

**Date:** 5/12/14  
**Vendor Name:** Badger Meter, Inc.  
**Product Name:** TFX Ultra Flow meter  
**Product Model Number:** TFX  
**Application Software Version:** 2.03  
**Firmware Revision:** N/A  
**BACnet Protocol Revision:** 10

#### Product Description:

Clamp-on ultrasonic flow and energy meter for liquids.

#### BACnet Standardized Device Profile (Annex L):

- BACnet Operator Workstation (B-OWS)
- BACnet Advanced Operator Workstation (B-AWS)
- BACnet Operator Display (B-OD)
- BACnet Building Controller (B-BC)
- BACnet Advanced Application Controller (B-AAC)
- BACnet Application Specific Controller (B-ASC)
- BACnet Smart Sensor (B-SS)
- BACnet Smart Actuator (B-SA)

#### List all BACnet Interoperability Building Blocks Supported (Annex K):

- Data Sharing-ReadProperty-B (DS-RP-B)
- Data Sharing-WriteProperty-B (DS-WP-B)
- Data Sharing - ReadProperty Multiple - B (DS-RPM-B)
- Data Sharing - WriteProperty Multiple - B (DS-WPM-B)
- Device Management-Dynamic Device Binding-B (DM-DDB-B)
- Device Management-DeviceCommunicationControl-B (DM-DCC-B)

#### Segmentation Capability:

- Able to transmit segmented messages Window Size \_\_\_\_\_
- Able to receive segmented messages Window Size \_\_\_\_\_

#### Standard Object Types Supported:

	Dynamically Create?	Dynamically Delete?	Optional Properties Supported	Writeable non-Required Properties	Proprietary Properties	Property Range Limits
1-Device Object	No	No	Location	Location		None special
25-Analog Input	No	No	None	None	Double_Value	None special
1-Binary Output	No	No	None	None	None	None special

**Data Link Layer Options:**

- BACnet IP, (Annex J)
- BACnet IP, (Annex J), Foreign Device
- ISO 8802-3, Ethernet (Clause 7)
- ATA 878.1, 2.5 Mb. ARCNET (Clause 8)
- ATA 878.1, EIA-485 ARCNET (Clause 8), baud rate(s) \_\_\_\_\_
- MS/TP master (Clause 9), baud rate(s): \_\_\_\_\_
- MS/TP slave (Clause 9), baud rate(s): \_\_\_\_\_
- Point-To-Point, EIA 232 (Clause 10), baud rate(s): \_\_\_\_\_
- Point-To-Point, modem, (Clause 10), baud rate(s): \_\_\_\_\_
- LonTalk, (Clause 11), medium: \_\_\_\_\_
- BACnet/ZigBee (ANNEX O)
- Other: \_\_\_\_\_

**Device Address Binding:**

Is static device binding supported? (This is currently necessary for two-way communication with MS/TP slaves and certain other devices.)  Yes  No

**Networking Options:**

- Router, Clause 6 - List all routing configurations, e.g., ARCNET-Ethernet, Ethernet-MS/TP, etc.
- Annex H, BACnet Tunneling Router over IP
- BACnet/IP Broadcast Management Device (BBMD)
  - Does the BBMD support registrations by Foreign Devices?  Yes  No
  - Does the BBMD support network address translation?  Yes  No

**Network Security Options:**

- Non-secure Device - is capable of operating without BACnet Network Security
- Secure Device - is capable of using BACnet Network Security (NS-SD BIBB)
  - Multiple Application-Specific Keys:
  - Supports encryption (NS-ED BIBB)
  - Key Server (NS-KS BIBB)

**Character Sets Supported:**

Indicating support for multiple character sets does not imply that they can all be supported simultaneously.

- ANSI X3.4
- ISO 10646 (UTF-8)  IBM  /Microsoft  DBCS  ISO 8859-1
- ISO 10646 (UCS-2)  ISO 10646 (UCS-4)  JIS X 0208

**If this product is a communication gateway, describe the types of non-BACnet equipment/networks(s) that the gateway supports:**

Not supported

## Ethernet Port Settings

### Changing IP Connections

Follow this procedure to get to the internal web page of the Ethernet Module. From the configuration page, you will be able to edit the Device ID and save the changes.

**NOTE:** Your actual internal web pages may differ in appearance from those below.

**NOTE:** USB-to-Ethernet adapter, skip to step 9. If connecting Ethernet directly, the Ethernet portion of the computer must be configured correctly.

1. Disconnect the Ethernet cable from the PC.
2. From the Control Panel, open **Network Connections**.

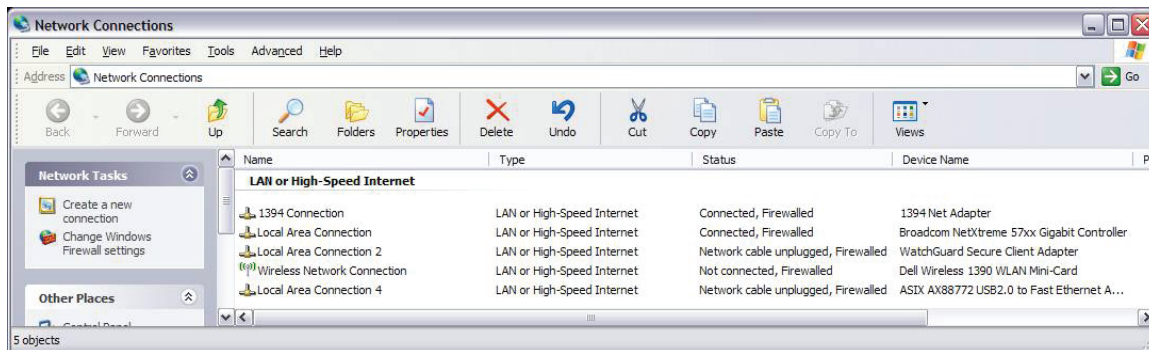

3. Double-click on the **Ethernet Adapter** (1394 is firewire, not Ethernet) to bring up its properties.

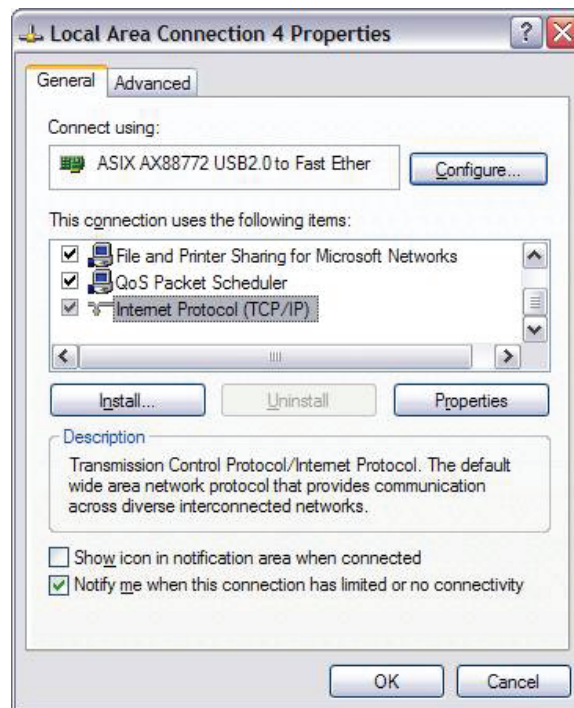

4. Scroll down and select **Internet Protocol (TCP/IP)**.
5. Click **Properties**.

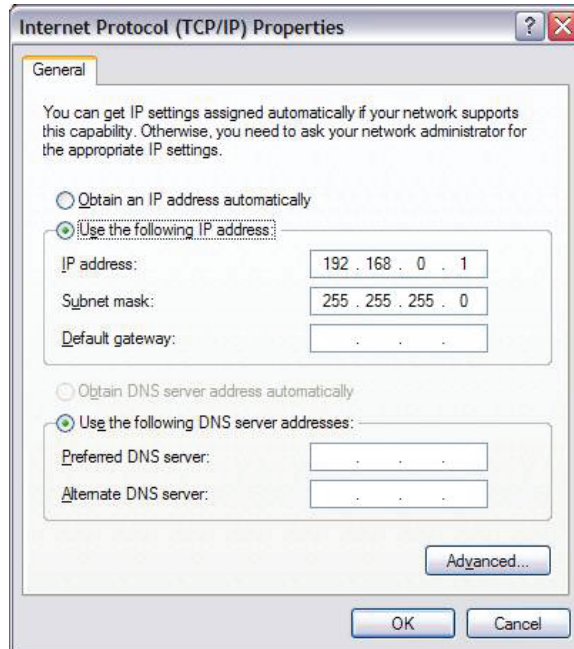

6. MAKE NOTE OF THE EXISTING IP ADDRESS AND SUBNET MASK! YOU WILL NEED TO CHANGE BACK WHEN FINISHED.  
**If this is not done, the PC will not re-connect to the original network.**
7. Enter the IP and Subnet mask shown above and click **OK**.
8. Click **Close** on the previous window.
9. Connect an Ethernet crossover cable between the PC and the Ethernet module.
10. Apply power to the transmitter.
11. Open Internet Explorer, type **http://192.168.0.100** in the address bar and click **Enter**.
12. Enter your user name and password. (The transmitter's factory default user name is Admin. The factory default password is blank.)





The *Main Page* refreshes every 5 seconds and provides real-time data from the transmitter.

The screenshot shows a web browser window with the address bar displaying `http://192.168.0.1/index.htm`. The page title is "Main Page" and the content is for "Room 205".

### Main Page

Room 205

---

#### Device Values

Signal Strength	44.0
Flow Rate	200.4
Net Totalizer	3397.7
Positive Totalizer	3397.7
Negative Totalizer	0.0
Temp 1 (deg C)	-40.0
Temp 2 (deg C)	-40.0
Diff Temp (1-2) (deg C)	0.0
Diff Temp (2-1) (deg C)	0.0
Abs Diff Temp (deg C)	0.0
Temp 1 (deg F)	-40.0
Temp 2 (deg F)	-40.0
Diff Temp (1-2) (deg F)	0.0
Diff Temp (2-1) (deg F)	0.0
Abs Diff Temp (deg F)	0.0
Flow Rate (GPM)	200.4
Flow Rate (LPM)	758.5
Flow Rate (CFH)	1607.2
Flow Rate (CMH)	45.5
Flow Rate (FPS)	6.9
Flow Rate (MPS)	2.1
Flow Unit Code	1.0
Total Unit Code	1.0
Total Exponent Unit Code	2.0
Time Unit Code	2.0

*This page will automatically refresh every 5 seconds*

[Configuration](#)

13. Click **Configuration** on the *Main Page* to display the *Ultrasonic Flow Meter* device configuration page.

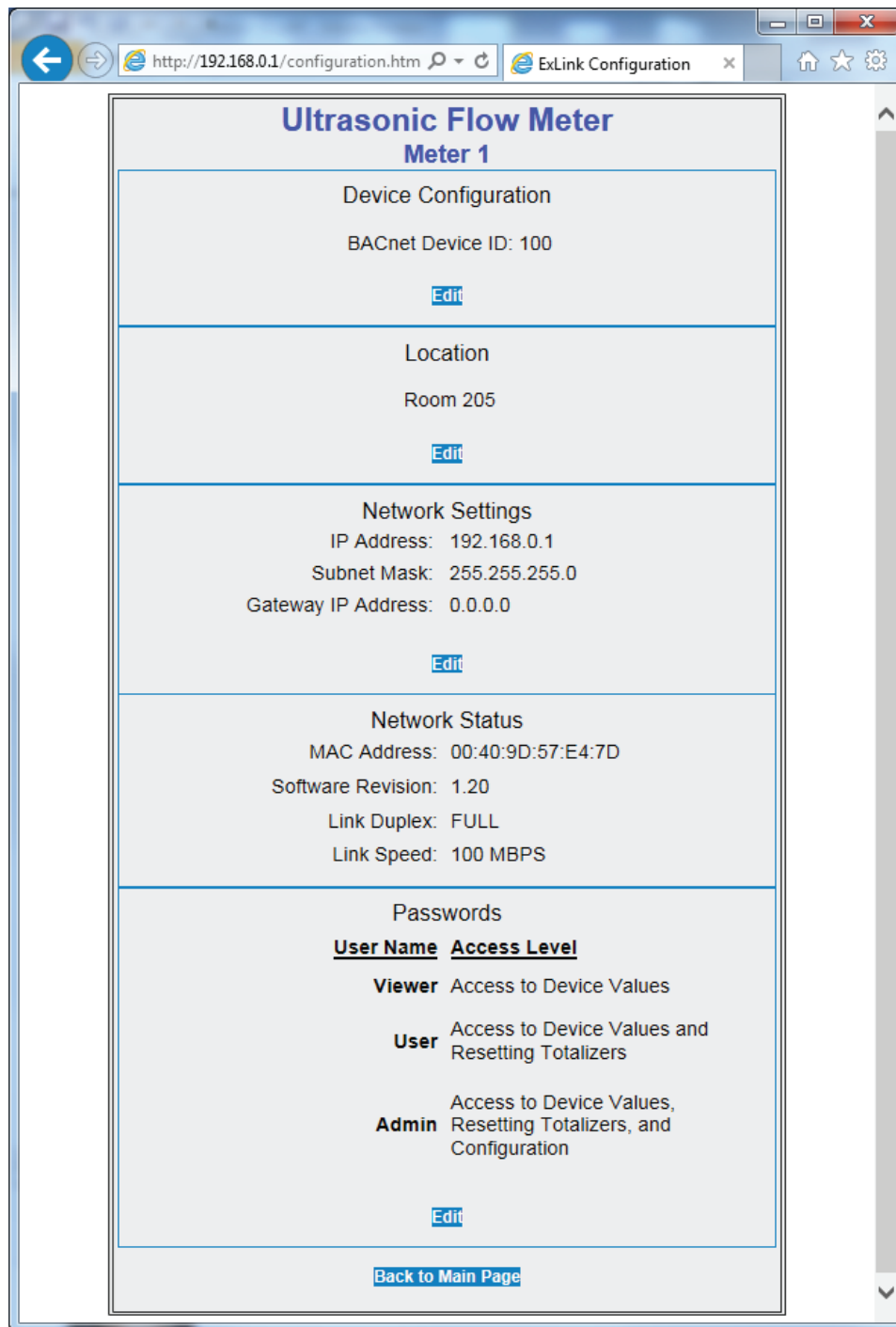

14. Click the **Edit** link to change Device Configuration, Location, Network Settings or Passwords.

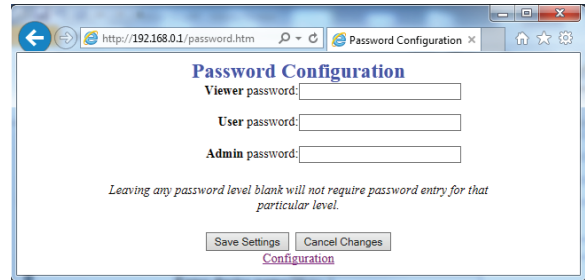
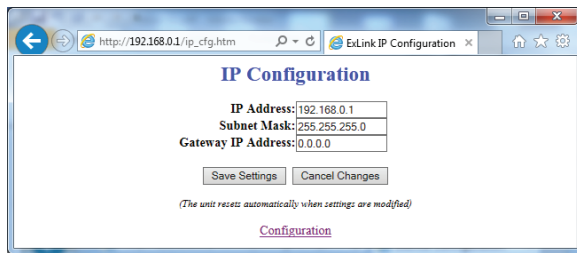
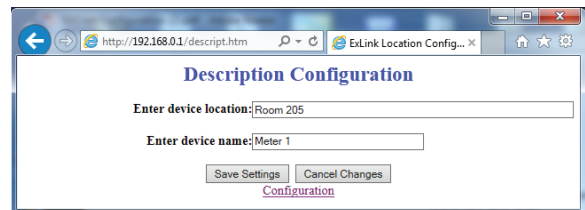
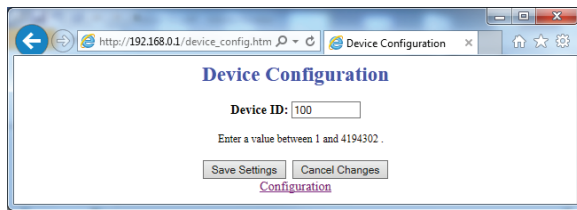

15. Make the necessary network changes and click **Save Settings**. Internet Explorer will no longer communicate with the module because its IP address has changed.

After the module resets and the adapter has been re-configured, you can then use the new IP address to connect to the internal webpage.

Also note you must choose an IP address that is not being used in the existing network.

16. Disconnect the Ethernet crossover cable and go back into the Ethernet adapter settings and restore the IP and subnet values saved from step 6.

The module should now be set up to work on the new network.

## Network Settings

IP address, IP subnet, IP gateway, and Device Description are configured through the web interface. IP address and subnet defaults to 192.168.0.100 and 255.255.255.0. Connection to the web interface requires an Ethernet crossover cable, power to the transmitter, and a PC with a web browser. Typing **http://192.168.0.100** in the address bar will allow connection to the transmitter's web interface for editing.

Access to the transmitter's data requires the entry of a user name and password. The transmitter's default user name is **admin** and the password is blank from the factory.

**NOTE:** Changing the IP address will require use of the new number when trying to access the web page. Each transmitter must be set up with a unique IP address when trying to network multiple transmitters.

## IMPORTANT

*When changes are made to the IP address, you must retain the new number for future access.*

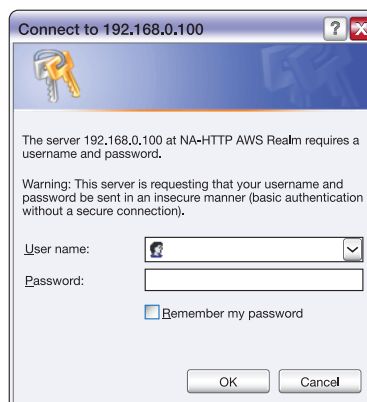

Figure 57: Network login screen

# TROUBLESHOOTING

## DTTS/DTTC Small Pipe Transducer Calibration Procedure

1. Establish communications with the transit time transmitter.
2. From the tool bar, select **Calibration**. See *Figure 60*.
3. On the pop-up screen, click **Next** twice to get to *Page 3 of 3*. See *Figure 58*.
4. Click **Edit**.
5. If a calibration point is displayed in *Calibration Points Editor*, record the information, then highlight and click **Remove**. See *Figure 59*.
6. Click **ADD...**
7. Enter Delta T, Un-calibrated Flow, and Calibrated Flow values from the DTTS/DTTC calibration label, then click **OK**. See *Figure 61*.
8. Click **OK** in the *Edit Calibration Points* screen.
9. The display will return to *Page 3 of 3*. Click **Finish**. See *Figure 58*.
10. After *Writing Configuration File* is complete, turn off the power. Turn on the power again to activate the new settings.

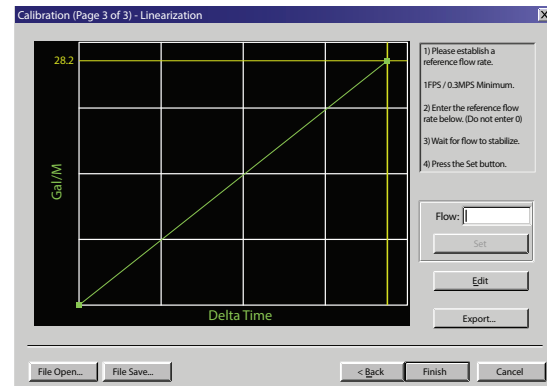

Figure 58: Calibration points editor

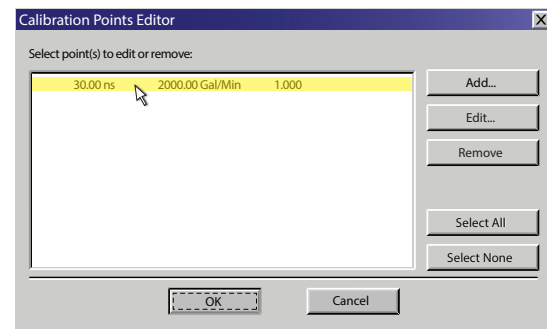

Figure 59: Calibration page 3 of 3

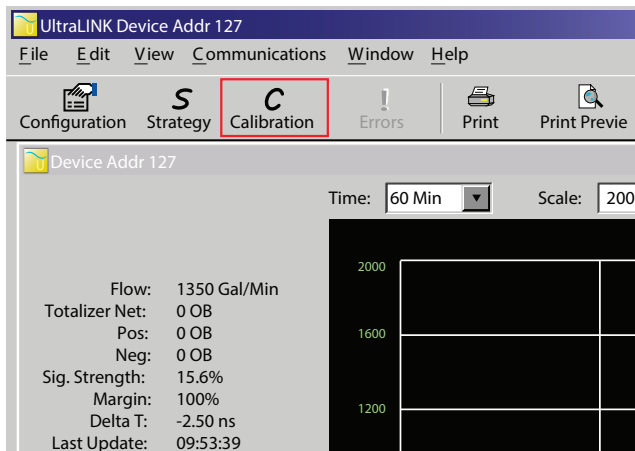

Figure 60: Data display screen

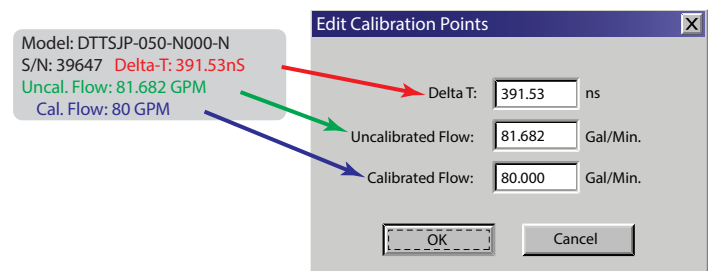

Figure 61: Edit calibration points

Warning and error message numbers are displayed in the flow measurement location when ERROR is displayed on the bottom of the screen. The error numbers correspond to the numbers listed for UltraLink.

Symptoms: Transmitter does not power up.

Possible Causes	Recommended Action
<ul style="list-style-type: none"> <li>No power or inadequate power</li> <li>Blown fuse (AC Model only)</li> <li>Display ribbon cable not seated properly</li> </ul>	<ul style="list-style-type: none"> <li>Measure voltage at the power terminals and check that the voltage matches the labels by the power terminals.</li> <li>Check the fuse near the power terminals. If fuse is blown, verify the voltage and polarity is correct and reset the fuse.</li> <li>Inspect ribbon cable connections. LED's on power board will light up – with no LCD display.</li> <li>Replace the transmitter if the above actions do not resolve the issue.</li> </ul>

Symptoms: Flow reading appears to be incorrect.

Possible Causes	Recommended Action
<ul style="list-style-type: none"> <li>Incorrect positioning of transducers</li> <li>Poor contact between transducers and pipe</li> <li>Poor placement of transducers</li> <li>Low signal strength</li> <li>Process loop issues</li> <li>Incorrect pipe settings</li> <li>Meter not calibrated?</li> <li>Display not set up correctly</li> </ul>	<p>Refer to the Transducer Mounting Configuration section for details on proper installation.</p> <p><b>At the transducer:</b></p> <ul style="list-style-type: none"> <li>Verify that the spacing of the transducers is set correctly. On most transducers, a scribe mark on the side of the transducers indicates the point of measurement—NOT from the end points of the transducers.</li> <li>Verify that the transducers are aligned correctly. For Z-Mount, verify the transducers are 180° from each other.</li> <li>Make sure there is a good contact between the transducers and pipe and a thin coat of acoustic coupling is applied. For integral mount, check for over-tightening of the transducers.</li> </ul> <p><b>Process loop and general location:</b></p> <ul style="list-style-type: none"> <li>Make sure the transducers are on the sides of the pipe and NOT on the top of the pipe.</li> <li>Check that the transducers are NOT located at the highest point in the loop where air may accumulate.</li> <li>Check that the transducers are NOT on a downward flowing pipe unless adequate downstream head pressure is present to overcome partial filling or cavitation.</li> <li>Check that the transducers have adequate straight pipe upstream and downstream.</li> <li>Check process loop for entrained air or particulates which will impact the flow readings.</li> <li>Pipes may develop scale, product build-up or corrosion over time. As a result, the effective wall thickness may be different than a new pipe and wall thickness or liner parameters may need to be adjusted (PIPE WT, LINER T, LINER MA, LINER SS, LINER R).</li> </ul> <p><b>At the transmitter:</b></p> <ul style="list-style-type: none"> <li>Verify that parameters match the installation: XDCR MNT, XDCR HZ, PIPE OD, PIPE WT, PIPE MAT, PIPE SS, PIPE R, LINER T, LINER MA, LINER SS, LINER R, FL TYPE, FLUID SS, FLUID VI, SP GRAVITY.</li> <li>Check that the SIG STR parameter in the Service Menu (SER MENU) is between 5...98. <ul style="list-style-type: none"> <li>◇ If the signal strength is greater than 98, change the mounting to increase the path length. For example from a Z-mount to V-mount or a V-mount to a W-mount. Repeat the startup and configuration steps.</li> <li>◇ If the signal strength is less than 5, change the mounting to decrease the path length. For example from a W-mount to a V-mount or a V-mount to a Z-mount. Repeat the startup and configuration steps.</li> </ul> </li> <li>Zero the meter. See "DTTS/DTTC Small Pipe Transducer Calibration Procedure" on page 88..</li> </ul>

Symptoms: Unstable flow.

Possible Causes	Recommended Action
<ul style="list-style-type: none"> <li>Installation issues</li> <li>Flow instability</li> <li>Transducers mounting is loose</li> <li>Transducers are moved</li> </ul>	<ul style="list-style-type: none"> <li>Check process loop for variations of entrained air which will impact the flow</li> <li>Check for pump induced flow instability.</li> <li>Ensure the transducers are secure and are in area where the transducers will not be inadvertently bumped or disturbed.</li> </ul>

*Symptoms: Flow readout is opposite of the flow direction.*

Possible Causes	Recommended Action
<ul style="list-style-type: none"> <li>Integral mount transmitter is mounted in reverse flow direction so display is properly oriented</li> <li>Up and down transducers wiring reversed</li> </ul>	<ul style="list-style-type: none"> <li>Change the transducer flow direction parameter (Basic Menu &gt; FLO DIR).</li> <li>Rewire the up and down transducers to the transmitter.</li> </ul>

*Symptoms: (Energy Models only) Energy reading appears to be incorrect.*

Possible Causes	Recommended Action
<ul style="list-style-type: none"> <li>Incorrect flow readings</li> <li>Incorrect temperature reading</li> </ul>	<p>Energy is directly calculated from the volumetric flow and temperature difference.</p> <ul style="list-style-type: none"> <li>Verify flow readings are within expected range:                             <ul style="list-style-type: none"> <li>◇ If in PROGRAM mode, press MENU to return to the RUN mode.</li> </ul> </li> <li>Verify temperatures readings are within expected range:                             <ul style="list-style-type: none"> <li>◇ Service Menu (SER) TEMP 1, TEMP 2 and TEMP DIFF</li> </ul> </li> </ul> <p>Refer to symptoms for incorrect flow and temperature readings.</p>

*Symptoms: (Energy Models only) Energy reading is opposite of the flow direction.*

Possible Causes	Recommended Action
<ul style="list-style-type: none"> <li>Flow reading is opposite the flow direction</li> <li>RTDs mounted in reverse order</li> </ul>	<ul style="list-style-type: none"> <li>Verify the flow reading is correct. If not, refer to symptom "Flow reading is opposite of the flow direction".</li> <li>If flow reading is correct, then verify RTD readings.                             <ul style="list-style-type: none"> <li>◇ Refer to symptom "Temperature (RTD) reading appears to be incorrect".</li> <li>◇ Swap the RTDs mounting locations.</li> <li>◇ In Rev S or later, change the RTD position parameter from NORMAL to SWAPPED: Basic Menu (BSC) &gt; RTD POS.</li> </ul> </li> </ul>

*Symptoms: (Energy Models only) Temperature (RTD) reading appears to be incorrect.*

Possible Causes	Recommended Action
<ul style="list-style-type: none"> <li>Incorrect wiring</li> <li>Cable issue</li> <li>RTD not functioning</li> <li>RTD needs recalibration</li> </ul>	<p>Refer to Heat Flow for Energy Models Only section for details on proper mounting and wiring.</p> <ul style="list-style-type: none"> <li>Check that the RTDs are properly wired to transmitter (pins RTD1 A and B, RTD2 A and B).</li> <li>For surface mount RTDs, verify that RTDs are installed on a well-insulated pipe. Ensure that the surface mounted RTDs have good thermal contact by verifying surface is bare metal and heat sink compound is used.</li> <li>Verify that the fluid temperature is within range of the RTD specifications.</li> <li>At the transmitter, disconnect the RTD wiring. Measure the resistance between pin #6 and pins #2/4, and between #5 and pins #1/3. The resistance should be 843... 2297 ohms depending on the fluid temperature. The resistance between pins #2 and #4, and #1 and #3 should be less than 5 ohms.                             <ul style="list-style-type: none"> <li>◇ If the measurements are significantly out of range or there appears to be an open or short in the cable, replace the RTD.</li> <li>◇ If the RTD appears to be functional, it may need to be recalibrated. See "In-Field Calibration of RTD Temperature Sensors" on page 92.</li> </ul> </li> </ul>

*Symptoms: Current, frequency or pulse outputs do not match the readings.*

Possible Causes	Recommended Action
<ul style="list-style-type: none"> <li>Incorrect parameter settings</li> <li>Wiring or control system configuration issues</li> </ul>	<p>Verify that the parameters for the output are set properly.</p> <ul style="list-style-type: none"> <li>4...20 mA: refer to FL 4MA and FL 20MA in the Channel 1 menu</li> <li>Frequency output (Flow-only meter): refer to MAX RATE in the Basic Menu (BSC)</li> <li>Totalizing pulse: refer to TOT MULT and TOTL E in the Basic Menu (BSC) for proper configuration. The pulse output is limited to one pulse per second. For frequency or pulse outputs, verify the proper switch settings, ground reference, voltage source and load compatible with the control system. Refer to Inputs/Outputs for proper wiring.</li> </ul>

## HEATING AND COOLING MEASUREMENT

The Energy model is designed to measure the rate and quantity of heat delivered to a given building, area or heat exchanger. The instrument measures the volumetric flow rate of the heat exchanger liquid (water, water/glycol mixture, brine, etc.), the temperature at the inlet pipe and the temperature at the outlet pipe. Heat delivery is calculated by the following equation:

### Rate of Heat Delivery

$$Q = \int_{V_0}^{V_1} K \Delta \theta dV$$

Where:

- Q** = Quantity of heat absorbed
- V** = Volume of liquid passed
- K** = Heat coefficient of the liquid
- Δθ** = Temperature difference between supply and return

Platinum RTD	
Type	1000 Ohm
Accuracy	±0.3 °C (0.0385 curve)
Temperature Response	Positive Temperature Coefficient

The RTD temperature measurement circuit in the Energy model measures the differential temperature of two 1000 Ohm, three-wire platinum RTDs. The three-wire configuration allows the temperature sensors to be located several hundred feet away from the transmitter without influencing system accuracy or stability.

The Energy model allows integration of two 1000 Ohm platinum RTDs with the energy transmitter, effectively providing an instrument for measuring energy delivered in liquid cooling and heating systems. If RTDs were ordered with the energy transmitter, they have been factory calibrated and are shipped connected to the module as they were calibrated.

Field replacement of RTDs is possible thru the use of the keypad or the UltraLink software utility. If the RTDs were ordered from the manufacturer of the Energy model, they will come with calibration values that need to be loaded into the Energy model.

New, non-calibrated RTDs will need to be field-calibrated using an ice bath and boiling water to derive calibration values. This procedure is outlined below.

## IN-FIELD CALIBRATION OF RTD TEMPERATURE SENSORS

Replacement RTD temperature sensors used in heat flow measurements must be calibrated in the field for proper operation. Failure to calibrate the RTDs to the specific BTU inputs will result in inaccurate heat-flow measurements.

### Equipment Required

- Ice Bath
- Boiling Water Bath
- Laboratory Grade Thermometer (accurate to 0.1 °C)
- Software Utility

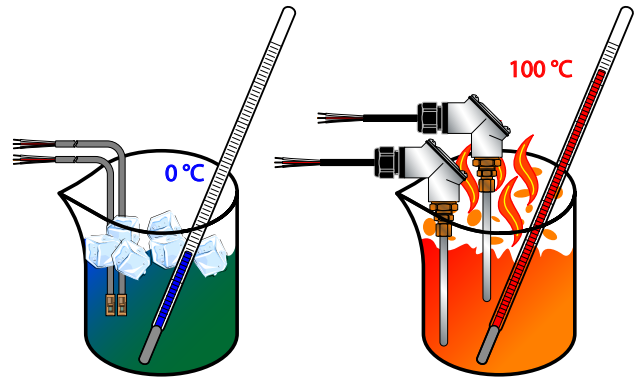

Figure 62: Standards of known temperature

### Replacing or Re-Calibrating RTDs

This procedure works with pairs of surface-mount RTDs or pairs of insertion RTDs supplied by the manufacturer of the Energy model.

1. Connect the RTDs.
2. Establish communications with the transmitter using the UltraLink software utility.
3. Click **Configuration** and select the **Output** tab.

The screen should now look something like the following:

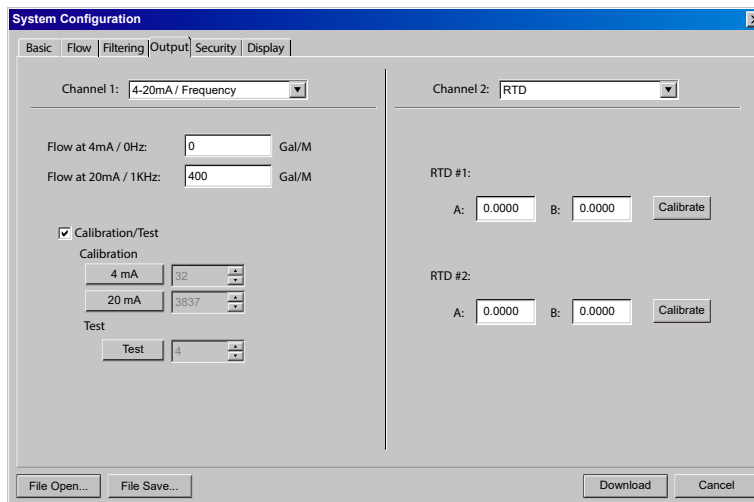

Figure 63: Output configuration screen

4. If **RTD** is not selected in the *Channel 2* dropdown list, select it now.
5. Insert both RTD temperature sensors and the laboratory grade thermometer into either the ice bath or the boiling water bath and allow about 20 minutes for the sensors to come up to the same temperature.

**NOTE:** An ice bath and boiling water bath are used in these examples because their temperatures are easy to maintain and provide known temperature reference points. Other temperature references can be used as long as there is a minimum delta T of 40° C between the two references.

**NOTE:** For maximum RTD temperature below 100° C, the hot water bath should be heated to the maximum temperature for that RTD.



- Click **Calibrate** and the following screen should now be visible. Make sure that the *Calibrate Both RTDs at same temperature* box is checked and then enter the temperature to the nearest 0.1° C in the box labeled *Reference Temp (deg C)*.

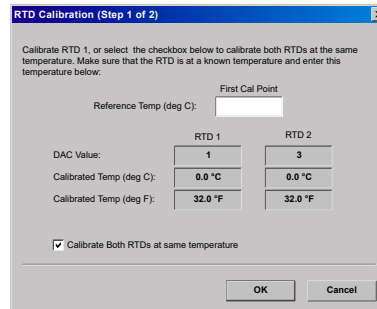

Figure 64: RTD calibration (Step 1 of 2)

- Click **Next**.
- The procedure for step 2 of 2 is similar to step 1 except the second water bath is used.
- Insert both RTD temperature sensors and the laboratory grade thermometer into the second water bath and allow about 20 minutes for the sensors to come up to the same temperature.
  - Make sure that the *Both RTDs at same temperature* box is checked and then enter the temperature to the nearest 0.1° C in the *Temp (deg C)* box.

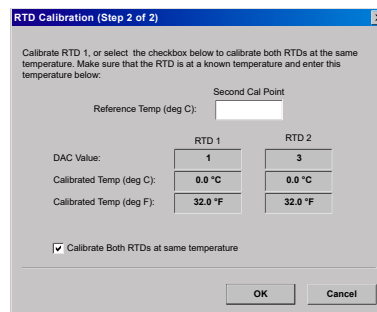

Figure 65: RTD calibration (Step 2 of 2)

- Click **OK**.
- Click **Download** on the *System Configuration* screen to save the calibration values to the transmitter. After the download is complete, cycle the transmitter power off and on to make the newly downloaded values take effect.

If the calibration points are not separated by at least 40° C or if either one or both of the RTDs are open, the following error message will be displayed:

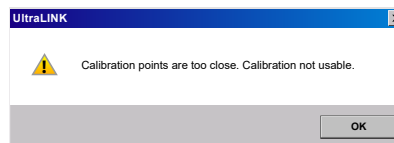

Figure 66: Calibration point error

Check the RTD's resistance values with an ohmmeter to make sure they are not "open" or "shorted". See *Table 21* for typical RTD resistance values. Next, check to make sure that no incorrect "Cal Point" values were entered inadvertently.

Heat Capacity of Water (J/g°C)										
°C	0	1	2	3	4	5	6	7	8	9
0	4.2174	4.2138	4.2104	4.2074	4.2045	4.2019	4.1996	4.1974	4.1954	4.1936
10	4.1919	4.1904	4.1890	4.1877	4.1866	4.1855	4.1846	4.1837	4.1829	4.1822
20	4.1816	4.0310	4.1805	4.1801	4.1797	4.1793	4.1790	4.1787	4.1785	4.1783
30	4.1782	4.1781	4.1780	4.1780	4.1779	4.1779	4.1780	4.1780	4.1781	4.1782
40	4.1783	4.1784	4.1786	4.1788	4.1789	4.1792	4.1794	4.1796	4.1799	4.1801
50	4.1804	4.0307	4.1811	4.1814	4.1817	4.1821	4.1825	4.1829	4.1833	4.1837
60	4.1841	4.1846	4.1850	4.1855	4.1860	4.1865	4.1871	4.1876	4.1882	4.1887
70	4.1893	4.1899	4.1905	4.1912	4.1918	4.1925	4.1932	4.1939	4.1946	4.1954
80	4.1961	4.1969	4.1977	4.1985	4.1994	4.2002	4.2011	4.2020	4.2029	4.2039
90	4.2048	4.2058	4.2068	4.2078	4.2089	4.2100	4.2111	4.2122	4.2133	4.2145

Table 20: Heat capacity of water

Standard RTD (Ohms)			
°C	°F	100 Ohm	1000 Ohm
-50	-58	80.306	803.06
-40	-40	84.271	842.71
-30	-22	88.222	882.22
-20	-4	92.160	921.60
-10	14	96.086	960.86
0	32	100.000	1000.00
10	50	103.903	1039.03
20	68	107.794	1077.94
25	77	109.735	1097.35
30	86	111.673	1116.73
40	104	115.541	1155.41
50	122	119.397	1193.97
60	140	123.242	1232.42
70	158	127.075	1270.75
80	176	130.897	1308.97
90	194	134.707	1347.07
100	212	138.506	1385.06
110	230	142.293	1422.93
120	248	146.068	1460.68
130	266	149.832	1498.32

Table 21: Standard RTD resistance values

# BRAD HARRISON® CONNECTOR OPTION

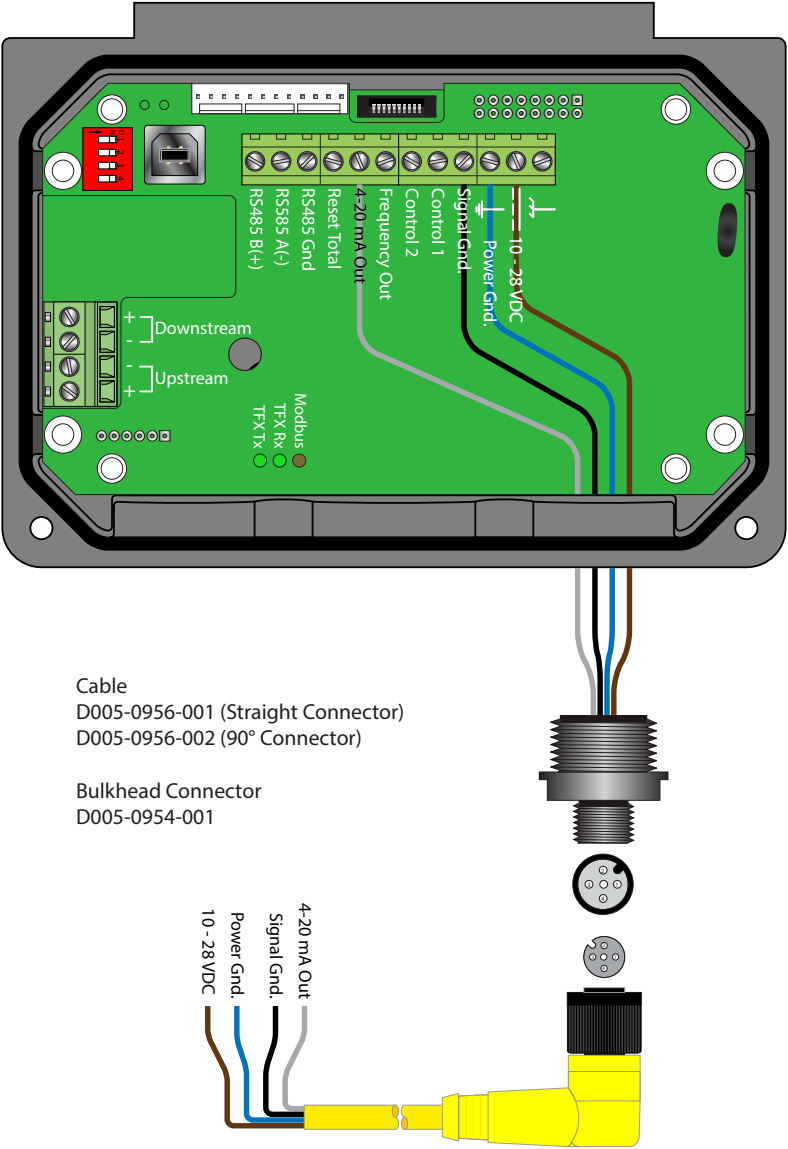

Cable  
D005-0956-001 (Straight Connector)  
D005-0956-002 (90° Connector)  
  
Bulkhead Connector  
D005-0954-001

Figure 67: Brad Harrison connections

## PRODUCT LABELS

**Model:**

Class 2 Supply Voltage: 10 – 28V DC @ 0.50A  
 Transmitter Only Operating Temperature: -40 < Ta < 75° C  
 Ⓜ II 3 G Ex ic nA IIB T4 Gc; Class I, Division 2, Groups C & D: T4  
 WHEN INSTALLED PER DRAWING D091-1054-003

**Warning:** Explosion Hazard - Do not open while the electrical circuit is powered unless area is known to be non-hazardous.

**Avertissement:** Risque d'explosion - Ne pas ouvrir le e'lectrique est alimente' si l'environnement n'est pas dangereux.

S/N:



Electrical and Hazardous  
 Location Safety  
 E112904



Assembled in USA

**Model:**

Rating: 95 – 264V AC ~ 47 – 63 Hz @ 0.15A  
 Transmitter Only Operating Temperature: -40 < Ta < 75° C  
 Ⓜ II 3 G Ex ic nA IIB T4 Gc; Class I, Division 2, Groups C & D: T4  
 WHEN INSTALLED PER DRAWING D091-1054-004

**Warning:** Explosion Hazard - Do not open while the electrical circuit is powered unless area is known to be non-hazardous.

**Avertissement:** Risque d'explosion - Ne pas ouvrir le e'lectrique est alimente' si l'environnement n'est pas dangereux.

S/N:



Electrical and Hazardous  
 Location Safety  
 E112904



Assembled in USA

**Model:**

Rating: 20 - 28VAC ~ 47-63 Hz @ 0.35A  
 Transmitter Only Operating Temperature: -40 to 85° C



ELECTRICAL SAFETY  
 E113055

S/N:

**Model:**

Rating: 95 - 264VAC ~ 47-63 Hz @ 0.15A  
 Transmitter Only Operating Temperature: -40 to 85° C



Electrical Safety  
 E112904

S/N:

**Model:**

Rating: 10 - 28VDC @ 0.5A  
 Transmitter Only Operating Temperature: -40 to 85° C



Electrical Safety  
 E112904

S/N:

Figure 68: Product labels

**INTENTIONAL BLANK PAGE**





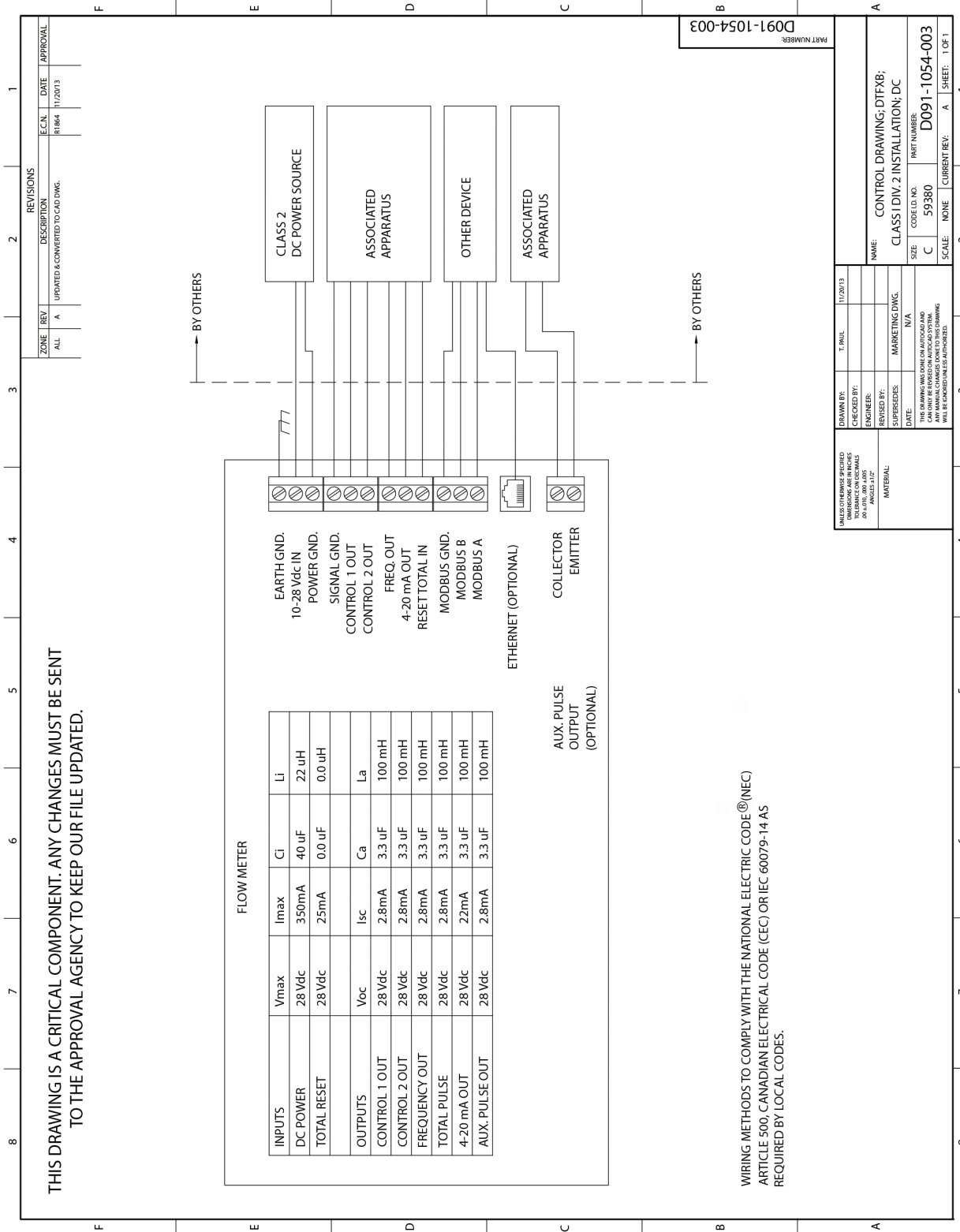

Figure 71: Control drawing



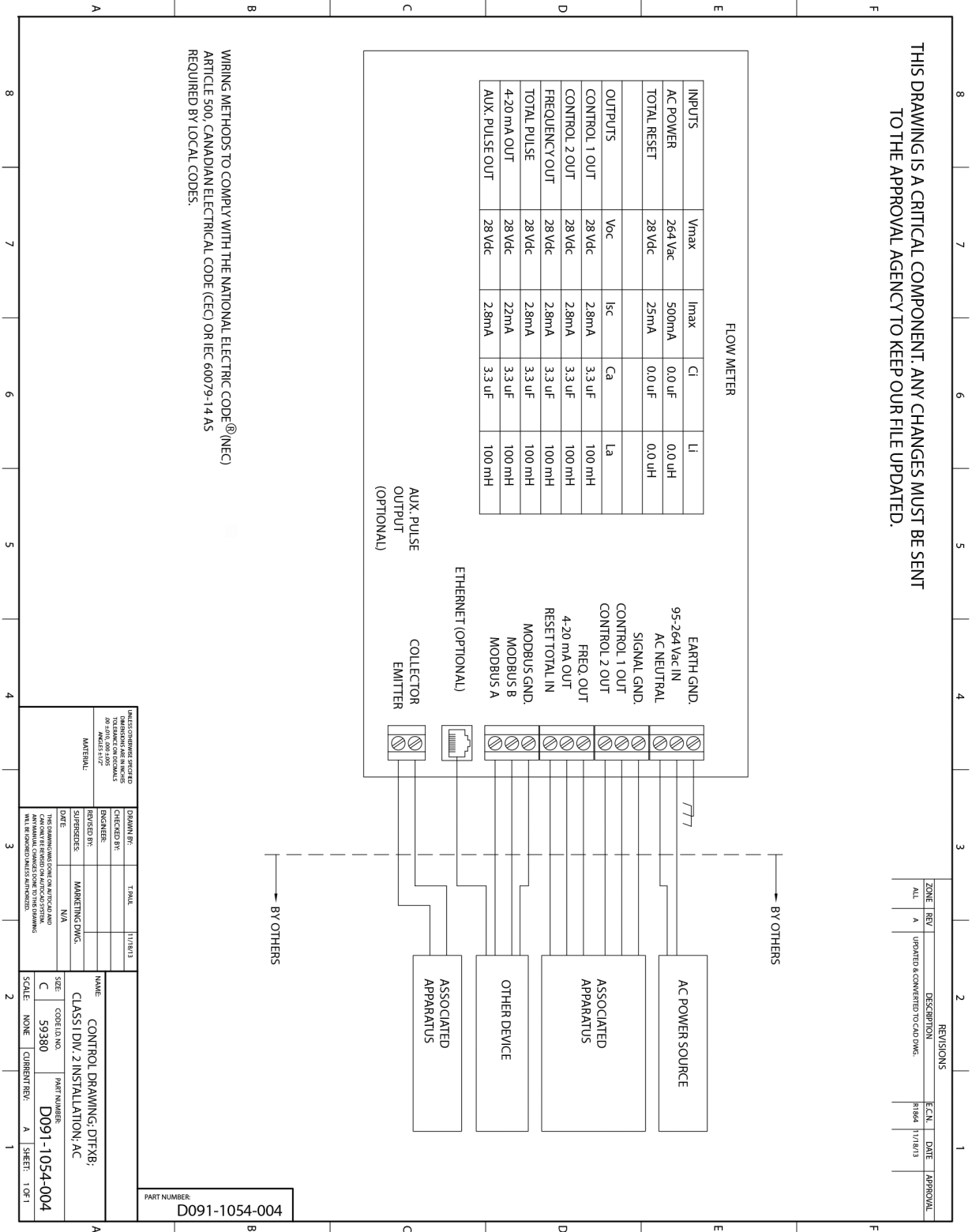

Figure 72: Control drawing Class 1 Div 2 installation, AC



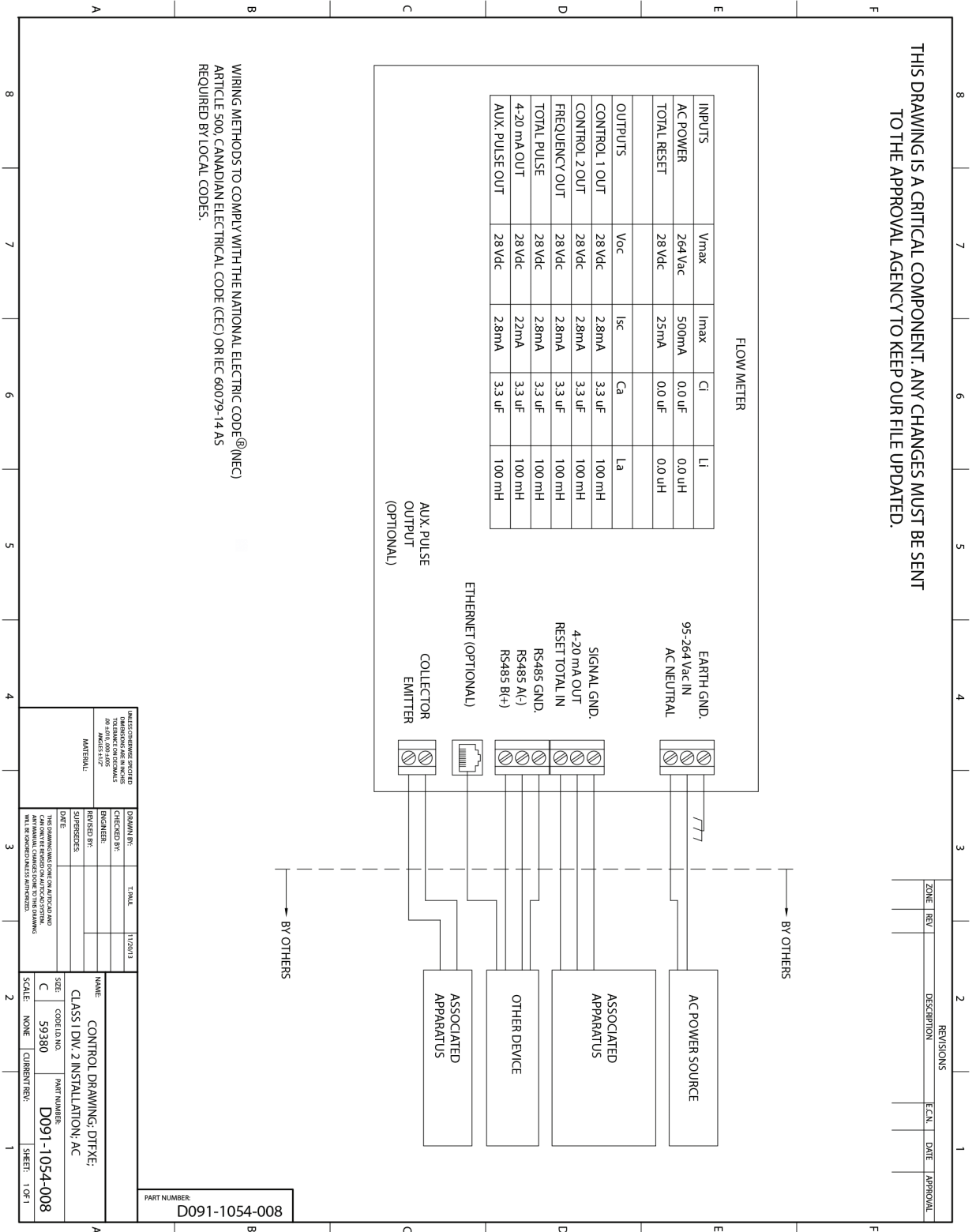

Figure 74: Control drawing Class 1 Div 2 installation, AC

# CE COMPLIANCE DRAWINGS

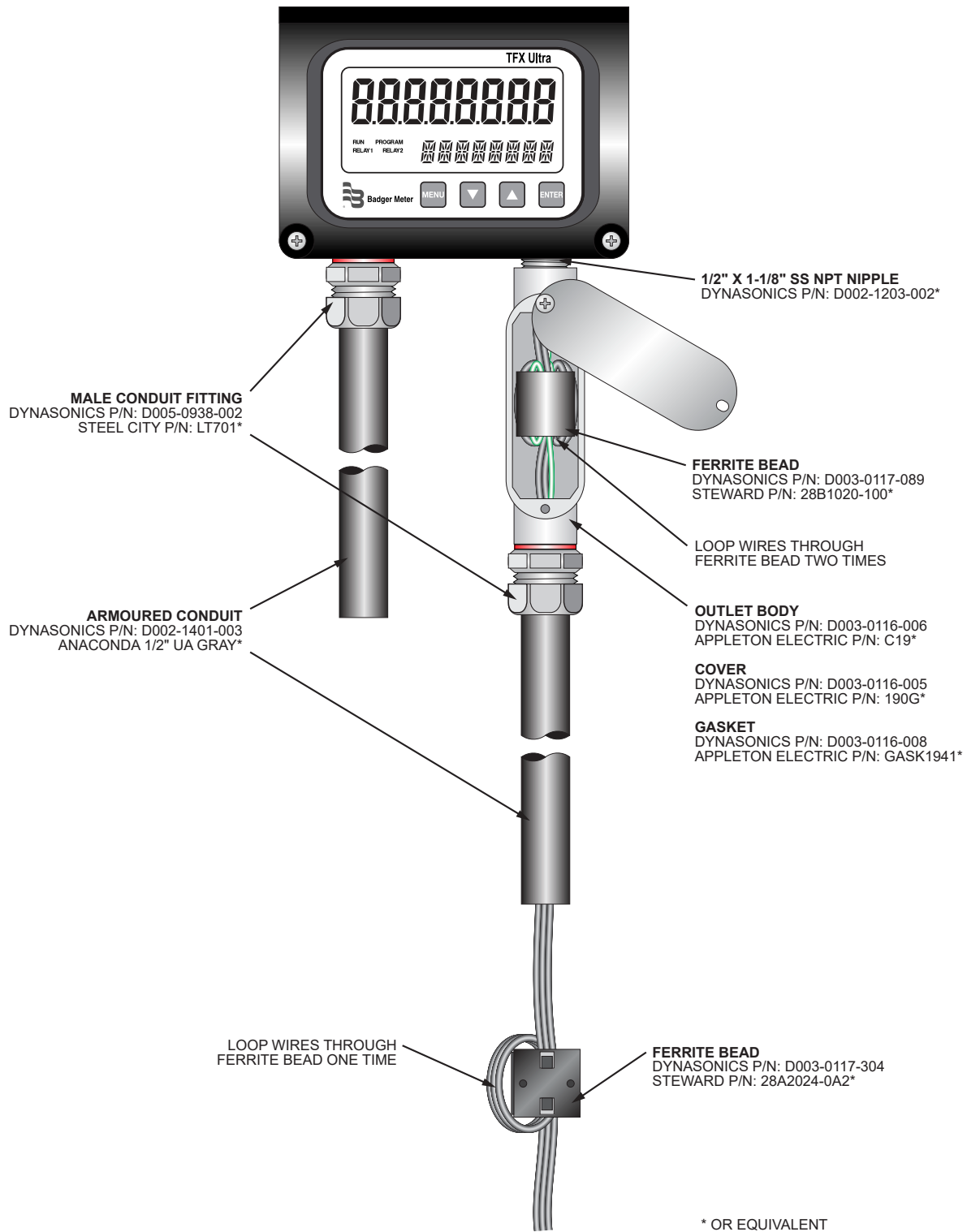

Figure 75: CE compliance drawing, AC power

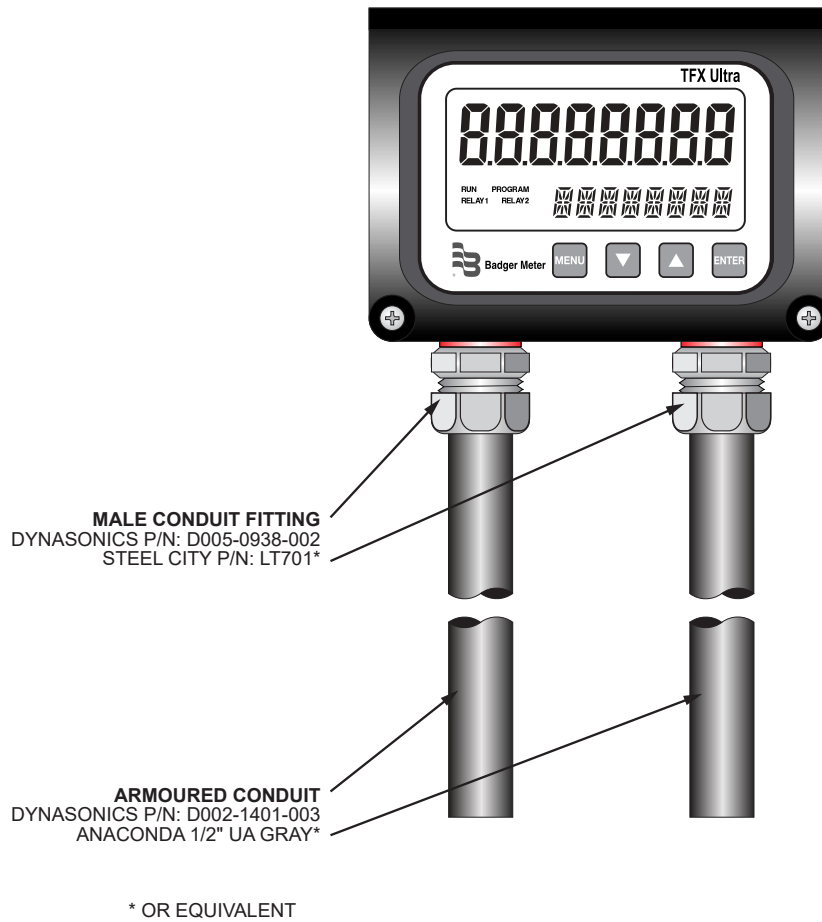

Figure 76: CE compliance drawing, DC power

## K FACTORS

### Description

The K factor (with regards to flow) is the number of pulses that must be accumulated to equal a particular volume of fluid. You can think of each pulse as representing a small fraction of the totalizing unit.

An example might be a K factor of 1000 (pulses per gallon). This means that if you were counting pulses, when the count total reached 1000, you would have accumulated one gallon of liquid. Using the same reasoning, each individual pulse represents an accumulation of 1/1000 of a gallon. This relationship is independent of the time it takes to accumulate the counts.

The frequency aspect of K factors is a little more confusing because it also involves the flow rate. The same K factor number, with a time frame added, can be converted into a flow rate. If you accumulated 1000 counts (one gallon) in one minute, then your flow rate would be one gpm. The output frequency, in Hz, is found simply by dividing the number of counts (1000) by the number of seconds in a minute (60) to get the output frequency.

$1000 \div 60 = 16.6666$  Hz. If you were looking at the pulse output on a frequency counter, an output frequency of 16.666 Hz would be equal to one gpm. If the frequency counter registered 33.333 Hz ( $2 \times 16.666$  Hz), then the flow rate would be two gpm.

Finally, if the flow rate is two gpm, then the accumulation of 1000 counts would take place in 30 seconds because the flow rate, and hence the speed that the 1000 counts is accumulated, is twice as great.

### Calculating K Factors

Many styles of transmitters are capable of measuring flow in a wide range of pipe sizes. Because the pipe size and volumetric units the transmitter will be used on vary, it may not be possible to provide a discrete K factor. In the event that a discrete K factor is not supplied then the velocity range of the transmitter is usually provided along with a maximum frequency output.

The most basic K factor calculation requires that an accurate flow rate and the output frequency associated with that flow rate be known.

#### Example 1

Known values are:

$$\text{Frequency} = 700 \text{ Hz}$$

$$\text{Flow Rate} = 48 \text{ gpm}$$

$$700 \text{ Hz} \times 60 \text{ sec} = 42,000 \text{ pulses per min}$$

$$\text{K factor} = \frac{42,000 \text{ pulses per min}}{48 \text{ gpm}} = 875 \text{ pulses per gallon}$$

#### Example 2

Known values are:

$$\text{Full Scale Flow Rate} = 85 \text{ gpm}$$

$$\text{Full Scale Output Frequency} = 650 \text{ Hz}$$

$$650 \text{ Hz} \times 60 \text{ sec} = 39,000 \text{ pulses per min}$$

$$\text{K factor} = \frac{39,000 \text{ pulses per min}}{85 \text{ gpm}} = 458.82 \text{ pulses per gallon}$$

The calculation is a little more complex if velocity is used because you first must convert the velocity into a volumetric flow rate to be able to compute a K factor.

To convert a velocity into a volumetric flow, the velocity measurement and an accurate measurement of the inside diameter of the pipe must be known. Also needed is the fact that one US gallon of liquid is equal to 231 cubic inches.

#### Example 3

Known values are:

$$\text{Velocity} = 4.3 \text{ ft/sec}$$

$$\text{Inside Diameter of Pipe} = 3.068 \text{ in.}$$

Find the area of the pipe cross section.

$$\text{Area} = \pi r^2$$

$$\text{Area} = \pi \left( \frac{3.068}{2} \right)^2 = \pi \times 2.35 = 7.39 \text{ in}^2$$

Find the volume in one foot of travel.

$$7.39 \text{ in}^2 \times 12 \text{ in. (1 ft)} = \frac{88.71 \text{ in}^3}{\text{ft}}$$

What portion of a gallon does one foot of travel represent?

$$\frac{88.71 \text{ in}^3}{231 \text{ in}^3} = 0.384 \text{ gallons}$$

So for every foot of fluid travel 0.384 gallons will pass.

What is the flow rate in gpm at 4.3 ft/sec?

$$0.384 \text{ gallons} \times 4.3 \text{ FPS} \times 60 \text{ sec (1 min)} = 99.1 \text{ gpm}$$

Now that the volumetric flow rate is known, all that is needed is an output frequency to determine the K factor.

Known values are:

$$\text{Frequency} = 700 \text{ Hz (By measurement)}$$

$$\text{Flow Rate} = 99.1 \text{ gpm (By calculation)}$$

$$700 \text{ Hz} \times 60 \text{ sec} = 42,000 \text{ pulses per gallon}$$

$$\text{K factor} = \frac{42,000 \text{ pulses per min}}{99.1 \text{ qpm}} = 423.9 \text{ pulses per gallon}$$

# SPECIFICATIONS

## System

<b>Liquid Types</b>	Most clean liquids or liquids containing small amounts of suspended solids or gas bubbles		
<b>Velocity Range</b>	Bi-directional to greater than 40 FPS (12 MPS)		
<b>Flow Accuracy</b>	DTTR/DTTN/DTTH/DTTL: ±1% of reading or ±0.01 FPS (0.003 MPS), whichever is greater DTTS/DTTC: 1 in. (25 mm) and larger = ±1 % above 1 FPS (0.3 MPS) and ±0.01 FPS below 1 FPS DTTS/DTTC: 3/4 in. (19 mm) and smaller = ±1% of full scale		
<b>Temperature Accuracy</b>	Option A: 32...122° F (0...50° C)	Absolute: 0.22° F (0.12° C)	Difference: 0.09° F (0.05° C)
<b>(Energy Models Only)</b>	Option B: 32...212° F (0...100° C)	Absolute: 0.45° F (0.25° C)	Difference: 0.18° F (0.1° C)
	Option C: -40...350° F (-40...177° C)	Absolute: 1.1° F (0.6° C)	Absolute: 1.1° F (0.6° C) Difference: 0.45° F (0.25° C)
	Option D: -4...85° F (-20...30° C)	Absolute: 0.22° F (0.12° C)	Absolute: 0.22° F (0.12° C) Difference: 0.09° F (0.05° C)
<b>Sensitivity</b>	Flow:	0.001 FPS (0.0003 MPS)	
	Temperature:		
	Option A:	0.03° F (0.012° C)	
	Option B:	0.05° F (0.025° C)	
	Option C:	0.1° F (0.06° C)	
Option D:	0.03° F (0.012° C)		
<b>Repeatability</b>	0.5% of reading		
<b>Installation Compliance</b>	General Safety (all models): UL 61010-1, CSA C22.2 No. 61010-1; (power options A and D only) EN 61010-1 Hazardous Location (power supply options A and D only): Class I Div. 2 Groups C, D, T4; Class II, Division 2, Groups F, G, T4; Class III Division 2 for US/CAN; Standards: UL 1604, CSA 22.2 No. 213, ANSI/ISA 12.12.01 (2013) Compliant with directives 2004/108/EC, 2006/95/EC and 94/9/EC on meter systems with integral flow transducers, transducers constructed with twinaxial cable (all transducers with cables 100 ft (30 m) and shorter) or remote transducers with conduit		

## Transmitter

<b>Power Requirements</b>	AC: 95...264 V AC 47...63 Hz @ 17 VA max. or 20...26 V AC 47...63 Hz @ 0.35 A max. DC: 10...28 V DC @ 5 W max. Protection: Auto resettable fuse, reverse polarity and transient suppression
<b>Display</b>	Two line LCD, LED backlight: Top row 0.7 inch (18 mm) height, 7-segment Bottom row 0.35 inch (9 mm) height, 14-segment
	Icons: RUN, PROGRAM, RELAY1, RELAY2
	Flow rate indication: 8-digit positive, 7-digit negative max. Auto decimal, lead zero blanking
	Flow accumulator (totalizer): 8-digit positive, 7-digit negative max. Reset via keypad, ULTRALINK, network command or momentary contact closure
<b>Enclosure</b>	NEMA Type 4 (IP-65) Construction: Powder-coated aluminum, polycarbonate, stainless steel, polyurethane, nickel-plated steel mounting brackets
	Size: 6.0 in. W x 4.4 in. H x 2.2 in. D (152 mm W x 112 mm H x 56 mm D)
	Conduit Holes: (2) 1/2 in. NPT female; (1) 3/4 in. NPT female; Optional Cable Gland Kit
<b>Temperature</b>	-40...131° F (-40...55° C) for line AC power with Ethernet option; -40...149° F (-40...65° C) for all others
<b>Configuration</b>	Via optional keypad or PC running ULTRALINK software ( <b>Note:</b> not all configuration parameters are available from the keypad—for example flow and temperature calibration and advanced filter settings)
<b>Engineering Units</b>	Flow-Only Model: Feet, gallons, cubic feet, million gallons, barrels (liquid and oil), acre-feet, pounds, meters, cubic meters, liters, million liters, kilograms
	Energy Model: Btu, mBtu, mmBtu, tons, kJ, kW, MW, kilocalorie, megacalorie
<b>Inputs/Outputs</b>	USB 2.0: For connection of a PC running ULTRALINK configuration utility
	RS485: Modbus RTU command set or BACnet® MSTP; Baud rates 9600, 14400, 19200, 38400, 56000, 57600, 76800
	Ethernet: Optional 10/100 Base T RJ45, communication via Modbus TCP/IP, EtherNet/IP, or BACnet/IP
	4-20 mA: 12-bit, internal power, can span negative to positive flow/energy rates
	Input: Reset totalizer when input is connected to signal ground
	Energy Model: Total Pulse: Opto isolated open collector transistor 2...28V DC, 100 mA max, 30 ms pulse width up to 16 Hz, 12-bit resolution, can span negative to positive rates; square-wave or turbine meter simulation outputs. Cannot be used with Ethernet option
	Flow-Only Model: Frequency Output: Open collector, 10...28V DC, 100 mA max, 0...1000 Hz; square wave or turbine meter simulation Two Alarm Outputs: Open-collector, 10...28V DC, 100 mA max, configure as rate alarm, signal strength alarm or totalizer pulse (100 ms pulse width up to 1 Hz max)



## Transducers

<b>Construction</b>	DTTR	NEMA 6*/IP67	PBT glass filled, Ultem, Nylon cord grip, PVC cable jacket; -40...250° F (-40...121° C)
	DTTC/DTTL	NEMA 6*/IP67	CPVC, Ultem, Nylon cord grip, PVC cable jacket; -40...194° F (-40...90° C)
	DTTN (IS)	NEMA 6*/IP67	CPVC, Ultem, Nylon cord grip, PVC cable jacket; -40...185° F (-40...85° C)
	DTTN/DTTL (Submersible)	NEMA 6P*/IP68	CPVC, Ultem, Nylon cord grip Polyethylene cable jacket; -40...194° F (-40...90° C)
	DTTH	NEMA 6*/IP67	PTFE, Vespel, Nickel-plated brass cord grip PFA cable jacket; -40...350° F (-40...176° C)
	DTTS	NEMA 6*/IP67	PVC, Ultem, Nylon cord grip, PVC cable jacket; -40...140° F (-40...60° C)
	*NEMA 6 units: to a depth of 3 ft (1 m) for 30 days max. NEMA 6P units: to a depth of 100 ft (30 m) seawater equivalent density indefinitely.		
<b>Frequency</b>	DTTS/DTTC: DTTR/DTTN/DTTH: DTTL:	2 MHz 1 MHz 500 KHz	
<b>Cables</b>	RG59 Coaxial or Twinaxial (optional armored conduit)		
<b>Cable Length</b>	990 ft (300 meter) max. in 5 ft (1.5 m) increments; Submersible Conduit limited to 100 ft (30 m)		
<b>RTDs (Energy Models Only)</b>	Platinum 385, 1000 ohm, 3-wire; PVC jacket cable		
<b>Installation</b>	DTTN (option N) /DTTR/DTTS/DTTH/DTTC:		General (see "Installation Compliance" on page 108)
	DTTN Transducer (option F) and IS Barrier D070-1010-002:		Class I Div. 1, Groups C&D T5 Intrinsically Safe Ex ia; CSA C22.2 No. 142 & 157; UL 913 & 916

## Software Utilities

<b>ULTRALINK</b>	Used to configure, calibrate and troubleshoot Flow-Only and Energy models. Connection via USB A/B cable; software is compatible with Windows® 2000, Windows XP, Windows Vista and Windows 7
------------------	---

# NORTH AMERICAN PIPE SCHEDULES

## Steel, Stainless Steel, PVC Pipe, Standard Classes

NPS in.	OD in.	SCH 60		X STG.		SCH 80		SCH 100		SCH 120/140		SCH 180					
		ID in.	Wall in.	ID in.	Wall in.	ID in.	Wall in.	ID in.	Wall in.	ID in.	Wall in.	ID in.	Wall in.				
1	1.315	—	—	0.957	0.179	0.957	0.179	—	—	—	—	0.815	0.250				
1.25	1.660			1.278	0.191	1.278	0.191					1.160	0.250				
1.5	1.900			1.500	0.200	1.500	0.200					1.338	0.281				
2	2.375			1.939	0.218	1.939	0.218					1.687	0.344				
2.5	2.875			2.323	0.276	2.323	0.276					2.125	0.375				
3	3.500			2.900	0.300	2.900	0.300					2.624	0.438				
3.5	4.000	—	—	3.364	0.318	3.364	0.318	—	—	—	—	—	—				
4	4.500			3.826	0.337	3.826	0.337							3.624	0.438	3.438	0.531
5	5.563			4.813	0.375	4.813	0.375							4.563	0.500	4.313	0.625
6	6.625			5.761	0.432	5.761	0.432							5.501	0.562	5.187	0.719
8	8.625	7.813	0.406	7.625	0.500	7.625	0.500	7.437	0.594	7.178	0.719	6.183	1.221				
10	10.75	9.750	0.500	9.75	0.500	9.562	0.594	9.312	0.719	9.062	0.844	8.500	1.125				
12	12.75	11.626	0.562	11.75	0.500	11.37	0.690	11.06	0.845	10.75	1.000	10.12	1.315				
14	14.00	12.814	0.593	13.00	0.500	12.50	0.750	12.31	0.845	11.81	1.095	11.18	1.410				
16	16.00	14.688	0.656	15.00	0.500	14.31	0.845	13.93	1.035	13.56	1.220	12.81	1.595				
18	18.00	16.564	0.718	17.00	0.500	16.12	0.940	15.68	1.160	15.25	1.375	14.43	1.785				
20	20.00	18.376	0.812	19.00	0.500	17.93	1.035	17.43	1.285	17.00	1.500	16.06	1.970				
24	24.00	22.126	0.937	23.00	0.500	21.56	1.220	20.93	1.535	20.93	1.535	19.31	2.345				
30	30.00	—	—	29.00	0.500	—	—	—	—	—	—	—	—				
36	36.00			35.00	0.500												
42	42.00			41.00	0.500												
48	48.00			47.00	0.500												

Table 22: Steel, stainless steel, PVC pipe, standard classes

## Steel, Stainless Steel, PVC Pipe, Standard Classes (continued)

NPS in.	OD in.	SCH 5		SCH 10 (Lt Wall)		SCH 20		SCH 30		STD		SCH 40	
		ID in.	Wall in.	ID in.	Wall in.	ID in.	Wall in.	ID in.	Wall in.	ID in.	Wall in.	ID in.	Wall in.
1	1.315	1.185	0.065	1.097	0.109	—	—	—	—	1.049	—	1.049	0.133
1.25	1.660	1.53	0.065	1.442	0.109					1.380		1.380	0.140
1.5	1.900	1.77	0.065	1.682	0.109					1.610		1.610	0.145
2	2.375	2.245	0.065	2.157	0.109					2.067		2.067	0.154
2.5	2.875	2.709	0.083	2.635	0.120					2.469		2.469	0.203
3	3.500	3.334	0.083	3.260	0.120					3.068		3.068	0.216
3.5	4.000	3.834	0.083	3.760	0.120	—	—	—	—	3.548	—	3.548	0.226
4	4.500	4.334	0.083	4.260	0.120					4.026	0.237	4.026	0.237
5	5.563	5.345	0.109	5.295	0.134					5.047	0.258	5.047	0.258
6	6.625	6.407	0.109	6.357	0.134					6.065	0.280	6.065	0.280
8	8.625	8.407	0.109	8.329	0.148	8.125	0.250	8.071	0.277	7.981	0.322	7.981	0.322
10	10.75	10.482	0.134	10.42	0.165	10.25	0.250	10.13	0.310	10.02	0.365	10.02	0.365
12	12.75	12.42	0.165	12.39	0.180	12.25	0.250	12.09	0.330	12.00	0.375	11.938	0.406
14	14.00	—	—	13.50	0.250	13.37	0.315	13.25	0.375	13.25	0.375	13.124	0.438
16	16.00			15.50	0.250	15.37	0.315	15.25	0.375	15.25	0.375	15.000	0.500
18	18.00			17.50	0.250	17.37	0.315	17.12	0.440	17.25	0.375	16.876	0.562
20	20.00			19.50	0.250	19.25	0.375	19.25	0.375	19.25	0.375	18.814	0.593
24	24.00			23.50	0.250	23.25	0.375	23.25	0.375	23.25	0.375	22.626	0.687
30	30.00	—	—	29.37	0.315	29.00	0.500	29.00	0.500	29.25	0.375	29.25	0.375
36	36.00			35.37	0.315	35.00	0.500	35.00	0.500	35.25	0.375	35.25	0.375
42	42.00			—	—	—	—	—	—	41.25	0.375	41.25	0.375
48	48.00			—	—	—	—	—	—	47.25	0.375	47.25	0.375

Table 23: Steel, stainless steel, PVC pipe, standard classes (continued)

**Copper Tubing, Copper and Brass Pipe, Aluminum**

Nominal Diameter in.		Copper Tubing in.			Copper & Brass Pipe in.	Alum. in.	Nominal Diameter in.		Copper Tubing in.			Copper & Brass Pipe in.	Alum. in.	
		Type							Type					
		K	L	M					K	L	M			
0.5	OD	0.625	0.625	0.625	0.840	—	3-1/2 in.	OD	3.625	3.625	3.625	4.000	—	
	Wall	0.049	0.040	0.028	0.108			Wall	0.120	0.100	0.083	0.250		
	ID	0.527	0.545	0.569	0.625			ID	3.385	3.425	3.459	3.500		
0.6250	OD	0.750	0.750	0.750	—	—	4 in.	OD	4.125	4.125	4.125	4.500	4.000	
	Wall	0.049	0.042	0.030				Wall	0.134	0.110	0.095	0.095	0.250	
	ID	0.652	0.666	0.690				ID	3.857	3.905	3.935	3.935	4.000	
0.75	OD	0.875	0.875	0.875	1.050	—	4-1/2 in.	OD	—	—	—	—	5.000	
	Wall	0.065	0.045	0.032	0.114			0.250						
	ID	0.745	0.785	0.811	0.822			4.500						
1	OD	1.125	1.125	1.125	1.315	—	5 in.	OD	5.125	5.125	5.125	5.563	5.000	
	Wall	0.065	0.050	0.035	0.127			Wall	0.160	0.125	0.109	0.250	0.063	
	ID	0.995	1.025	1.055	1.062			ID	4.805	4.875	4.907	5.063	4.874	
1.25	OD	1.375	1.375	1.375	1.660	—	6 in.	OD	6.125	6.125	6.125	6.625	6.000	
	Wall	0.065	0.055	0.042	0.146			Wall	0.192	0.140	0.122	0.250	0.063	
	ID	1.245	1.265	1.291	1.368			ID	5.741	5.845	5.881	6.125	5.874	
1.5.	OD	1.625	1.625	1.625	1.900	—	7 in.	OD	—	—	—	—	7.625	7.000
	Wall	0.072	0.060	0.049	0.150			Wall					0.282	0.078
	ID	1.481	1.505	1.527	1.600			ID					7.062	6.844
2	OD	2.125	2.125	2.125	2.375	—	8 in.	OD	8.125	8.125	8.125	8.625	8.000	
	Wall	0.083	0.070	0.058	0.157			Wall	0.271	0.200	0.170	0.313	0.094	
	ID	1.959	1.985	2.009	2.062			ID	7.583	7.725	7.785	8.000	7.812	
2.5	OD	2.625	2.625	2.625	2.875	2.500	10 in.	OD	10.125	10.125	10.125	10.000	—	
	Wall	0.095	0.080	0.065	0.188	0.050		Wall	0.338	0.250	0.212	0.094	—	
	ID	2.435	2.465	2.495	2.500	2.400		ID	9.449	9.625	9.701	9.812	—	
3	OD	3.125	3.125	3.125	3.500	3.000	12 in.	OD	12.125	12.125	12.125	—	—	
	Wall	0.109	0.090	0.072	0.219	0.050		Wall	0.405	0.280	0.254	—	—	
	ID	2.907	2.945	2.981	3.062	2.900		ID	11.315	11.565	11.617	—	—	

Table 24: Copper tubing, copper and brass pipe, aluminum

## Cast Iron Pipe, Standard Classes, 3...20 inch

Size in.		Class in.							
		A	B	C	D	E	F	G	H
3	OD	3.80	3.96	3.96	3.96	—	—	—	—
	Wall	0.39	0.42	0.45	0.48				
	ID	3.02	3.12	3.06	3.00				
4	OD	4.80	5.00	5.00	5.00	—	—	—	—
	Wall	0.42	0.45	0.48	0.52				
	ID	3.96	4.10	4.04	3.96				
6	OD	6.90	7.10	7.10	7.10	7.22	7.22	7.38	7.38
	Wall	0.44	0.48	0.51	0.55	0.58	0.61	0.65	0.69
	ID	6.02	6.14	6.08	6.00	6.06	6.00	6.08	6.00
8	OD	9.05	9.05	9.30	9.30	9.42	9.42	9.60	9.60
	Wall	0.46	0.51	0.56	0.60	0.66	0.66	0.75	0.80
	ID	8.13	8.03	8.18	8.10	8.10	8.10	8.10	8.00
10	OD	11.10	11.10	11.40	11.40	11.60	11.60	11.84	11.84
	Wall	0.50	0.57	0.62	0.68	0.74	0.80	0.86	0.92
	ID	10.10	9.96	10.16	10.04	10.12	10.00	10.12	10.00
12	OD	13.20	13.20	13.50	13.50	13.78	13.78	14.08	14.08
	Wall	0.54	0.62	0.68	0.75	0.82	0.89	0.97	1.04
	ID	12.12	11.96	12.14	12.00	12.14	12.00	12.14	12.00
14	OD	15.30	15.30	15.65	15.65	15.98	15.98	16.32	16.32
	Wall	0.57	0.66	0.74	0.82	0.90	0.99	1.07	1.16
	ID	14.16	13.98	14.17	14.01	14.18	14.00	14.18	14.00
16	OD	17.40	17.40	17.80	17.80	18.16	18.16	18.54	18.54
	Wall	0.60	0.70	0.80	0.89	0.98	1.08	1.18	1.27
	ID	16.20	16.00	16.20	16.02	16.20	16.00	16.18	16.00
18	OD	19.50	19.50	19.92	19.92	20.34	20.34	20.78	20.78
	Wall	0.64	0.75	0.87	0.96	1.07	1.17	1.28	1.39
	ID	18.22	18.00	18.18	18.00	18.20	18.00	18.22	18.00
20	OD	21.60	21.60	22.06	22.06	22.54	22.54	23.02	23.02
	Wall	0.67	0.80	0.92	1.03	1.15	1.27	1.39	1.51
	ID	20.26	20.00	20.22	20.00	20.24	20.00	20.24	20.00

Table 25: Cast iron pipe, standard classes, 3...20 inch

**Cast Iron Pipe, Standard Classes, 24...84 inch**

Size in.		Class in.							
		A	B	C	D	E	F	G	H
24	OD	25.80	25.80	26.32	26.32	26.90	26.90	27.76	27.76
	Wall	0.76	0.98	1.05	1.16	1.31	1.45	1.75	1.88
	ID	24.28	24.02	24.22	24.00	24.28	24.00	24.26	24.00
30	OD	31.74	32.00	32.40	32.74	33.10	33.46	—	
	Wall	0.88	1.03	1.20	1.37	1.55	1.73		
	ID	29.98	29.94	30.00	30.00	30.00	30.00		
36	OD	37.96	38.30	38.70	39.16	39.60	40.04	—	
	Wall	0.99	1.15	1.36	1.58	1.80	2.02		
	ID	35.98	36.00	35.98	36.00	36.00	36.00		
42	OD	44.20	44.50	45.10	45.58	—			
	Wall	1.10	1.28	1.54	1.78				
	ID	42.00	41.94	42.02	42.02				
48	OD	50.55	50.80	51.40	51.98	—			
	Wall	1.26	1.42	1.71	1.99				
	ID	47.98	47.96	47.98	48.00				
54	OD	56.66	57.10	57.80	58.40	—			
	Wall	1.35	1.55	1.90	2.23				
	ID	53.96	54.00	54.00	53.94				
60	OD	62.80	63.40	64.20	64.28	—			
	Wall	1.39	1.67	2.00	2.38				
	ID	60.02	60.06	60.20	60.06				
72	OD	75.34	76.00	76.88	—				
	Wall	1.62	1.95	2.39					
	ID	72.10	72.10	72.10					
84	OD	87.54	88.54	—					
	Wall	1.72	2.22						
	ID	84.10	84.10						

Table 26: Cast iron pipe, standard classes, 24...84 inch

## FLUID PROPERTIES

Fluid	Specific Gravity 20° C	Sound Speed		delta-v/° C m/s/° C	Kinematic Viscosity (cSt)	Absolute Viscosity (Cp)
		ft/s	m/s			
Acetate, Butyl	—	4163.9	1270	—	—	—
Acetate, Ethyl	0.901	3559.7	1085	4.4	0.489	0.441
Acetate, Methyl	0.934	3973.1	1211	—	0.407	0.380
Acetate, Propyl	—	4196.7	1280	—	—	—
Acetone	0.79	3851.7	1174	4.5	0.399	0.316
Alcohol	0.79	3960.0	1207	4.0	1.396	1.101
Alcohol, Butyl	0.83	4163.9	1270	3.3	3.239	2.688
Alcohol, Ethyl	0.83	3868.9	1180	4	1.396	1.159
Alcohol, Methyl	0.791	3672.1	1120	2.92	0.695	0.550
Alcohol, Propyl	—	3836.1	1170	—	—	—
Alcohol, Propyl	0.78	4009.2	1222	—	2.549	1.988
Ammonia	0.77	5672.6	1729	6.7	0.292	0.225
Aniline	1.02	5377.3	1639	4.0	3.630	3.710
Benzene	0.88	4284.8	1306	4.7	0.7 11	0.625
Benzol, Ethyl	0.867	4389.8	1338	—	0.797	0.691
Bromine	2.93	2916.7	889	3.0	0.323	0.946
n-Butane	0.60	3559.7	1085	5.8	—	—
Butyrate, Ethyl	—	3836.1	1170	—	—	—
Carbon dioxide	1.10	2752.6	839	7.7	0.137	0.151
Carbon tetrachloride	1.60	3038.1	926	2.5	0.607	0.968
Chloro-benezene	1.11	4176.5	1273	3.6	0.722	0.799
Chloroform	1.49	3211.9	979	3.4	0.550	0.819
Diethyl ether	0.71	3231.6	985	4.9	0.3 11	0.222
Diethyl Ketone	—	4295.1	1310	—	—	—
Diethylene glycol	1.12	5203.4	1586	2.4	—	—
Ethanol	0.79	3960.0	1207	4.0	1.390	1.097
Ethyl alcohol	0.79	3960.0	1207	4.0	1.396	1.101
Ether	0.71	3231.6	985	4.9	0.3 11	0.222
Ethyl ether	0.71	3231.6	985	4.9	0.3 11	0.222
Ethylene glycol	1.11	5439.6	1658	2.1	17.208	19.153
Freon R12	—	2540	774.2	—	—	—
Gasoline	0.7	4098.4	1250	—	—	—
Glycerin	1.26	6246.7	1904	2.2	757.100	953.946
Glycol	1.11	5439.6	1658	2.1	—	—
Isobutanol	0.81	3976.4	1212	—	—	—
Iso-Butane	—	4002	1219.8	—	—	—
Isopentane	0.62	3215.2	980	4.8	0.340	0.211
Isopropanol	0.79	3838.6	1170	—	2.718	2.134

Fluid	Specific Gravity 20° C	Sound Speed		delta-v/° C m/s/° C	Kinematic Viscosity (cSt)	Absolute Viscosity (Cp)
		ft/s	m/s			
Isopropyl Alcohol	0.79	3838.6	1170	—	2.718	2.134
Kerosene	0.81	4343.8	1324	3.6	—	—
Linalool	—	4590.2	1400	—	—	—
Linseed Oil	0.925...0.939	5803.3	1770	—	—	—
Methanol	0.79	3530.2	1076	2.92	0.695	0.550
Methyl Alcohol	0.79	3530.2	1076	2.92	0.695	0.550
Methylene Chloride	1.33	3510.5	1070	3.94	0.310	0.411
Methylethyl Ketone	—	3967.2	1210	—	—	—
Motor Oil (SAE 20/30)	0.88...0.935	4875.4	1487	—	—	—
Octane	0.70	3845.1	1172	4.14	0.730	0.513
Oil, Castor	0.97	4845.8	1477	3.6	0.670	0.649
Oil, Diesel	0.80	4101	1250	—	—	—
Oil (Lubricating X200)	—	5019.9	1530	—	—	—
Oil (Olive)	0.91	4694.9	1431	2.75	100.000	91 .200
Oil (Peanut)	0.94	4783.5	1458	—	—	—
Paraffin Oil	—	4655.7	1420	—	—	—
Pentane	0.626	3346.5	1020	—	0.363	0.227
Petroleum	0.876	4229.5	1290	—	—	—
1-Propanol	0.78	4009.2	1222	—	—	—
Refrigerant 11	1.49	2717.5	828.3	3.56	—	—
Refrigerant 12	1.52	2539.7	774.1	4.24	—	—
Refrigerant 14	1.75	2871.5	875.24	6.61	—	—
Refrigerant 21	1.43	2923.2	891	3.97	—	—
Refrigerant 22	1.49	2932.7	893.9	4.79	—	—
Refrigerant 113	1.56	2571.2	783.7	3.44	—	—
Refrigerant 114	1.46	2182.7	665.3	3.73	—	—
Refrigerant 115	—	2153.5	656.4	4.42	—	—
Refrigerant C318	1.62	1883.2	574	3.88	—	—
Silicone (30 cp)	0.99	3248	990	—	30.000	29.790
Toluene	0.87	4357	1328	4.27	0.644	0.558
Transformer Oil	—	4557.4	1390	—	—	—
Trichlorethylene	—	3442.6	1050	—	—	—
1,1,1 -Trichloroethane	1.33	3231.6	985	—	0.902	1.200
Turpentine	0.88	4117.5	1255	—	1.400	1.232
Water, distilled	0.996	4914.7	1498	-2.4	1.000	0.996
Water, heavy	1	4593	1400	—	—	—
Water, sea	1.025	5023	1531	-2.4	1.000	1.025
Wood Alcohol	0.791	3530.2	1076	2.92	0.695	0.550
m-Xylene	0.868	4406.2	1343	—	0.749	0.650
o-Xylene	0.897	4368.4	1331.5	4.1	0.903	0.810
p-Xylene	—	4376.8	1334	—	0.662	—

Table 27: Fluid properties