

Linking your system



Overview

Temperature sensor adopts PT1000 thermal resistance detecting devices, mainly used to monitor the temperature and temperature compensation or overheat protection. Temperature sensor is a kind of widely used sensor, It is widely used in boiler system, cooling system, air condition system, warehouse temperature control system, process control system and so on.

Applications



- Monitor temperature of cooling water of mould to increase or decrease the volume of flow of cooling water or to warn.
- Detect temperature of enzymes or other chemicals in containers.
- Detect temperature in liquid waste processing systems.



- Detect temperature of oil in pipes of wind power equipments.

Controls and visual indication

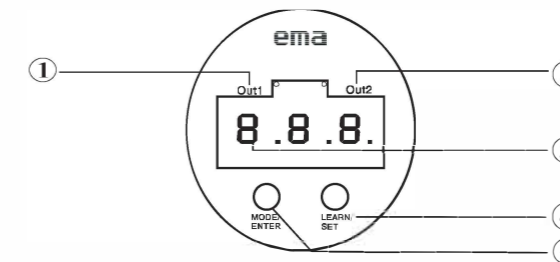

Temperature sensors



ema's temperature sensors detect the operating temperature by PT1000 devices and then transmits the data to an examining circuit. After processing, the current operating temperature is displayed through LED and converted automatically into a digital (NPN, PNP) or an analogue (0-10V, 4-20mA) signal.



①	Out1	Out1 connected, LED light on
②	Out2	Out2 connected, LED light on
③	7-segment LED	displays system temperature, parameters and setting value
④	LEARN/SET	Setting of learn mode and parameter value
⑤	MODE/ENTER	Selection of parameter and acknowledgement of parameter value

Functions and features

By the probe, the temperature sensor can detect and then display the current system temperature ($^{\circ}\text{C}$ or $^{\circ}\text{F}$); meanwhile, it can generate two signals according to the setting of output.

Output 1	Output 2
Hysteresis/N.O.(Hno)	Analogue output
Hysteresis function/N.C.(Hnc)	4~20mA(1)
window function/N.O.(Fno)	Analogue output
window function/N.C.(Fnc)	0~10V(U)

Measuring range

$^{\circ}\text{C}$	-40~150
$^{\circ}\text{F}$	-40~302

Hysteresis

The hysteresis keeps the switching state of the outputs stable if the system temperature varies about the preset value. When the system temperature is rising, the output switches when the switch-on point has been reached (SP1); when the system temperature is falling again, the output switch-off point (rP1) has been reached. The hysteresis can be adjusted: first the switch-on point is set, then the switch-on point with the requested difference.

Window function :

The window function enables the monitoring of a defined acceptable range. When the system temperature varies between the switch-on point (SP1) and the switch-off point (rP1), the output is switched (window function/NO) or not switched (window function/NC). The width of the window can be set by means of the difference between SP1 and rP1. SP1 = upper value, rP1=lower value.

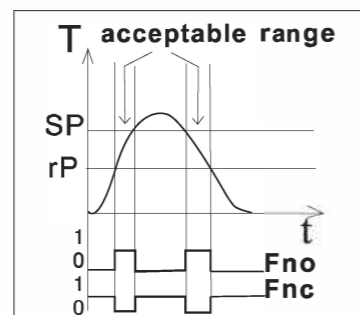
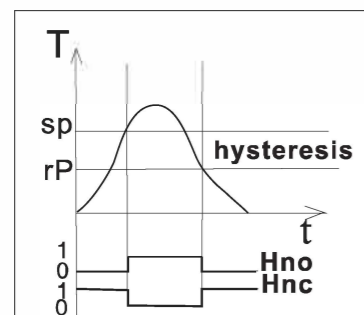

Operating modes

Run mode:(Normal operating mode)

- When the supply voltage has been applied, the unit is in the run mode .it monitors and switches the transistor output according to the set parameters.
The value of the analog output depends on the system temperature.
- The LED display indicates the current system temperature, the red LED indicates the switching state of the transistor output.

Display mode:(Indication of parameters and the set parameter values)

- When the "MODE/ENTER" button is pressed briefly, the unit passes to the display mode which allows parameter values to be read. The internal sensing, processing and output functions of the unit continue as if in run mode.
- The parameter names are scrolled with each pressing of the "MODE/ENTER" button.
- when the "SET" button is pressed briefly, the corresponding parameter value is displayed for 5 sec.. After another 5 sec. The unit returns to the run mode.

Programming

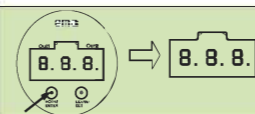
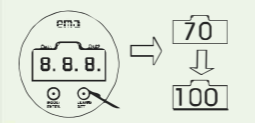
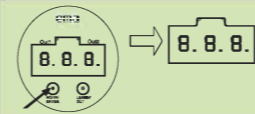
1		Press the MODE/ENTER button several times until the respective parameter is displayed.
2		Press the set button and keep it pressed. The current parameter value is indicated in 5 sec., then the value is increased (incremental by pressing briefly or scrolling by holding pressed).
3		Press the MODE/ENTER button briefly (=acknowledgement). The parameter is displayed again; the set parameter value becomes effective.
Wait 5 sec. (the unit passes to the operating mode and the current measured value is indicated again), or start again		

- Decrease parameter value:** Make the parameter value displayed reach the maximum setting of the parameter value, and then recycle from the minimum value to the maximum value
- Lock:** The device has automatically lock function. If no key pressed when it is in the run mode, it will automatically lock the pushbuttons, normally detect temperature fluctuations, and output control value.
- Unlock:** When it is in normal pressure display state(run mode), long press LEARN/SET, then press MODE/ENTER, maintaining 10 seconds, until display ULC the device is unlocked. All devices from the factory are locked.

Setting / Operation

Detecting secure of device if the operation works effective. Fault situations:

HI	Temperature is too high
LO	Temperature is too low
Sc1	(Flashing) = short-circuit or overload in the switching output; the output is switched off.

Mounting and maintenance

- The probe is not allowed to touch the wall of pipe.
- This product should be mounted in the position which can sense the temperature.
- When this product is mounted in the bottom of the pipe, please clear the sediments; when on the top of the pipe, please make the medium full of the pipe.
- Please inspect the probe of the sensor regularly. If necessary, use vinegar to clear up the sediments stuck on the probe.

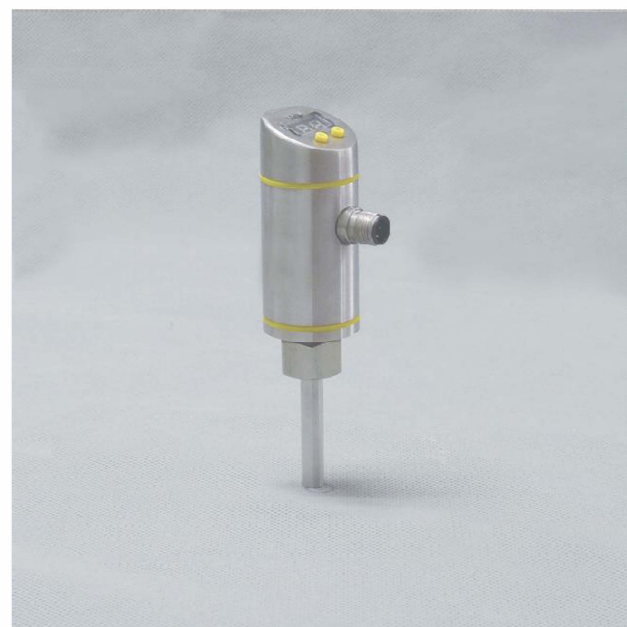



- Programmable temperature sensors
- Can be set 2 units of temperature, °C and °F
- High accuracy, High stability, Anti-corrosion
- Users can set temperature range and switch point easily via the buttons
- No calibration required and long lift-time
- All stainless steel structure and the rating is up to IP68



Order NO.

Order NO.	Thread (Internal)	Medium Temperature (°C/°F)	Supply Voltage (V)	Output 1	Output 2	Probe Length (mm)	Drawing No.
TA1004	M18*1.5	- 40...+150/-40...+302	18~36 DC	PNP NO/NC NPN NO/NC	0~10V, 4~20mA	45	E3T01
TA1005	M18*1.5	- 40...+150/-40...+302	18~36 DC	PNP NO/NC NPN NO/NC	PNP NO/NC NPN NO/NC	45	E3T01
TA1006	M18*1.5	- 40...+150/-40...+302	18~36 DC	PNP NO/NC NPN NO/NC	0~10V, 4~20mA	100	E3T01
TA1007	M18*1.5	- 40...+150/-40...+302	18~36 DC	PNP NO/NC NPN NO/NC	PNP NO/NC NPN NO/NC	100	E3T01

Accessories:

Type	Connector Order No.						Drawing No.
	C	02	I	5	C	12	I:E3U11
	C: Cable	Length 02: 2M 05: 5M 10: 10M	Connector I: Straight L: Angled	Pole 4: 4 5: 5	Material R: PUR C: PVC S: PVC Shielded Wire	Size 12: M12	L:E3U12

Order No.	US0001	US0002	US0003	US0007	US0009
Type					
	M18 x 1.5 – M12 x 1	M18 x 1.5 – G1/4"	M18 x 1.5 – G1/2"	M18 x 1.5 – Ø24mm	M18 x 1.5 – M18 x 1.5
Drawing No.	E3U01	E3U02	E3U03	E3U07	E3U08

Technical parameters:

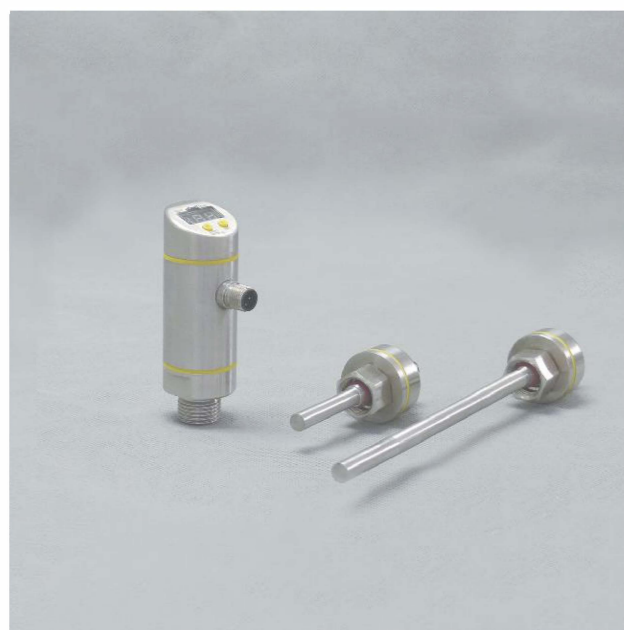

Sensing element PT1000
 Probe material: Stainless steel 316L
 Connection: M12 Socket
 Pressure rating[bar]: 300
 Voltage drop[V]: <3.5
 Power-on delay time [s] : 1.5
 Sensing/display cycle time[ms]:200
 Switching output accuracy[°C]: ± 0.2
 Analogue output accuracy[°C]: ± (0.2+0.4% measuring interval)



- Smart remote temperature sensor
- Used for long-distance measurement
- Three combined units: control monitor, cable, probe
- Users can set temperature range and switch point easily
- Programmable temperature sensors
- Can be set 2 units of temperature, °C and °F
- All stainless steel structure and the rating is up to IP68



Accessories:

Type	Connector Order No.						Drawing No.
	C	02	I	5	C	12	I:E3U11
I	C: Cable	Length 02: 2M 05: 5M 10: 10M	Connector I: Straight L: Angled	Pole 4: 4 5: 5	Material R: PUR C: PVC S: PVC Shielded Wire	Size 12: M12	L:E3U12
							L

Order No.	US0001	US0002	US0003	US0007	US0009
Type					
	M18 x 1.5 – M12 x 1	M18 x 1.5 – G1/4"	M18 x 1.5 – G1/2"	M18 x 1.5 – Ø24mm	M18 x 1.5 – M18 x 1.5
Drawing No.	E3U01	E3U02	E3U03	E3U07	E3U08

Order NO.

TB control monitors

Order NO.	Thread Type	Thread	Medium Temperature (°C/°F)	Supply Voltage (V)	Output 1	Output 2	Drawing No.
TB1004	External	G1/2" A	- 40...+150/-40...+302	18~36 DC	PNP NO/NC NPN NO/NC	0~10V, 4~20mA	E3T04
TB1005	External	G1/2" A	- 40...+150/-40...+302	18~36 DC	PNP NO/NC NPN NO/NC	PNP NO/NC NPN NO/NC	E3T04

TD probe units

Order NO.	Thread Type	Thread	Medium Temperature (°C/°F)	Sensing element	Probe Length (mm)	Drawing No.
TD1000	Internal	M18"x1.5	- 40...+150/-40...+302	PT1000	45mm	E3T05
TD1001	Internal	M18"x1.5	- 40...+150/-40...+302	PT1000	160mm	E3T05
TD1002	Internal	M18"x1.5	- 40...+150/-40...+302	PT1000	260mm	E3T05
TD1003	Internal	M18"x1.5	- 40...+150/-40...+302	PT1000	360mm	E3T05

Type	Cable Order No.						Drawing No.
	C	02	J	5	R	12	J : E3U10
J	C: Cable	Length 02: 2M 05: 5M 10: 10M	J : Jumper male/female	Pole 5: 5	R: PUR	Size 12: M12	

Technical parameters:

Sensing element : PT1000
 Probe material: Stainless steel 316L
 Connection: M12 Socket
 Pressure rating[bar]: 300
 Voltage drop[V]: <3.5
 Power-on delay time [s] : 1.5
 Sensing/display cycle time[ms]:200
 Switching output accuracy[°C]: ± 0.2
 Analogue output accuracy[°C]: ± (0.2+0.4% measuring interval)



- Simple structure, Easy installation, No calibration required
- Shock resistance and anti-corrosion
- Medium temperature: $-40... +100\text{ }^{\circ}\text{C}$ / $-40... +212\text{ }^{\circ}\text{F}$
- High accuracy and high stability
- All stainless steel structure and the rating is up to IP68



Order NO.

Order NO.	Thread (External)	Medium Temperature ($^{\circ}\text{C}/^{\circ}\text{F}$)	Supply Voltage (V)	Output	Probe Length (mm)	Drawing No.
TC0102	G1/2" A	-40~+100/-40...+212	18~36 DC	4~20mA	10	E3T03
TC0103	G1/2" A	-40~+100/-40...+212	18~36 DC	0~10V	10	E3T03
TC0104	G1/4" A	-40~+100/-40...+212	18~36 DC	4~20mA	60	E3T03
TC0105	G1/4" A	-40~+100/-40...+212	18~36 DC	0~10V	60	E3T03

Accessories:

Type	Connector Order No.						Drawing No.
	C	02	I	5	C	12	I:E3U11
I	C: Cable	Length	Connector	Pole	Material	Size	L:E3U12
L		02: 2M 05: 5M 10: 10M	I: Straight L: Angled	4: 4 5: 5	R: PUR C: PVC S: PVC Shielded wire	12: M12	

Technical parameters:

Sensing element :PT1000
 Probe material: Stainless steel 316L
 Connection: M12 Socket
 Pressure rating[bar]: 300
 Voltage drop[V]: <3.5
 Power-on delay time [s] : 1.5
 Sensing/display cycle time[ms]:200
 Analogue output accuracy[$^{\circ}\text{C}$]: <3
 Accuracy [$^{\circ}\text{C}$]: ± 0.2





- This electronic temperature sensors meet the standard of hygienic design
- Can be set 2 units of temperature, °C or °F
- High accuracy, High stability, Anti-corrosion
- Users can set pressure range and switch point via buttons easily
- All stainless steel structure and the rating is up to IP69K



Order NO.

Order NO.	Thread (External)	Medium Temperature (°C/°F)	Supply Voltage (V)	Output 1	Output 2	Probe Length (mm)	Drawing No.
TA3201	G3/4"A	- 40...+150/-40...+302	18~36 DC	PNP NO/NC NPN NO/NC	0~10V, 4~20mA	45	E3T02
TA3202	G3/4"A	- 40...+150/-40...+302	18~36 DC	PNP NO/NC NPN NO/NC	PNP NO/NC NPN NO/NC	45	E3T02

Accessories:

Type	Connector Order No.						Drawing No.
	C	02	I	5	C	12	I:E3U11
	C: Cable	Length 02: 2M 05: 5M 10: 10M	Connector I: Straight L: Angled	Pole 4: 4 5: 5	Material R: PUR C: PVC S: PVC Shielded Wire	Size 12: M12	L:E3U12

Order No.	US0061	US0062
Type	 Hygienic welding adapter	 Hygienic Tri Clamp adapter
Drawing No.	E3U15	E3U16

Technical parameters:

Sensing element :PT1000
 Probe material: Stainless steel 316L
 Connection: M12 Socket
 Pressure rating[bar]: 300
 Voltage drop[V]:<3.5
 Power-on delay time [ms]: 1.5
 Sensing/display cycle time [ms]:200
 Accuracy [°C]: ± 2

Flow sensors/Pressure sensors

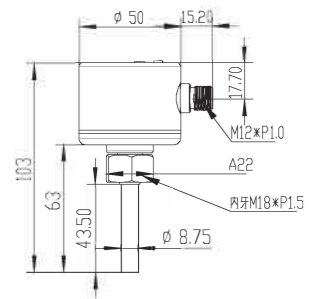

E3F01

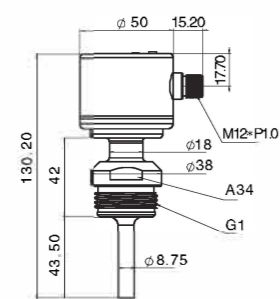

E3F02

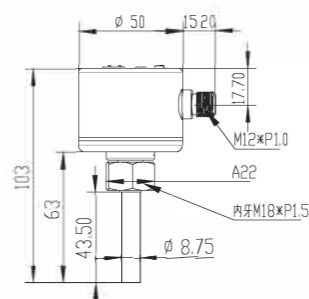

E3F03

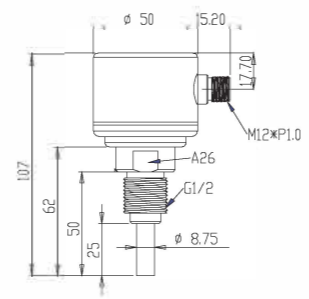

E3F04

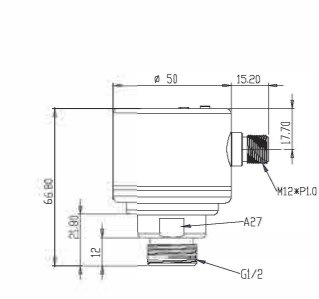

E3F05

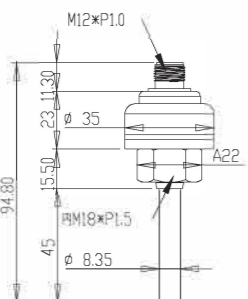

E3F06

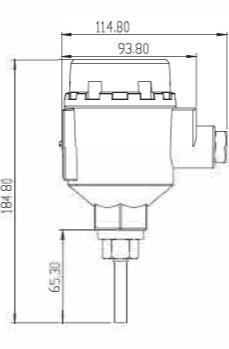
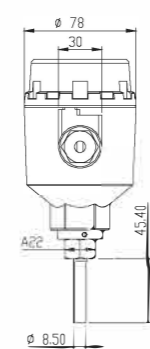

Pressure sensors /Temperature sensors

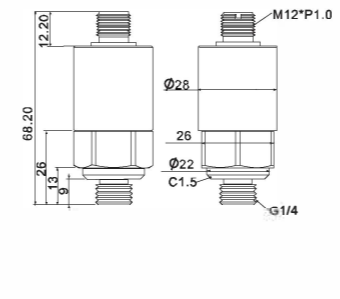

E3P05

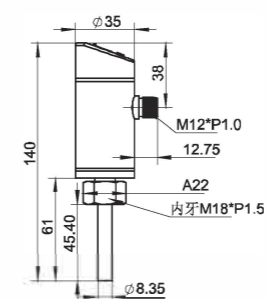

E3T01

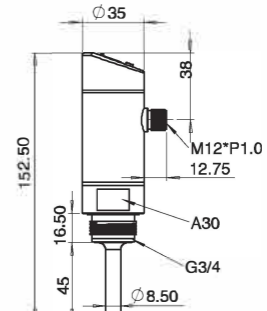

E3T02

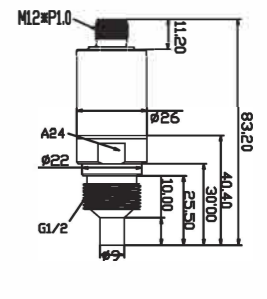

E3T03

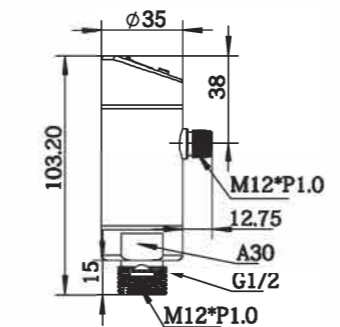

E3T04

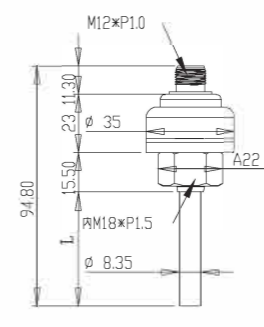

E3T05

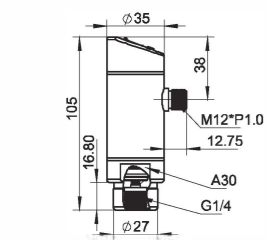

E3P01

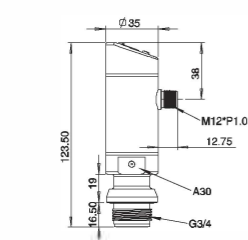

E3P02

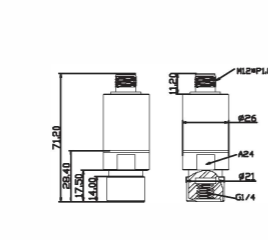

E3P03

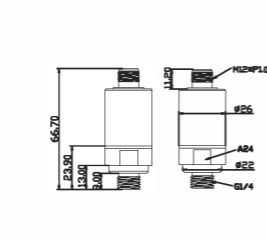

E3P04

Temperature sensors/Adapters

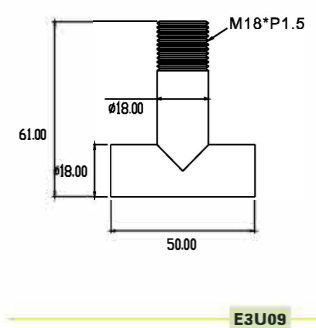
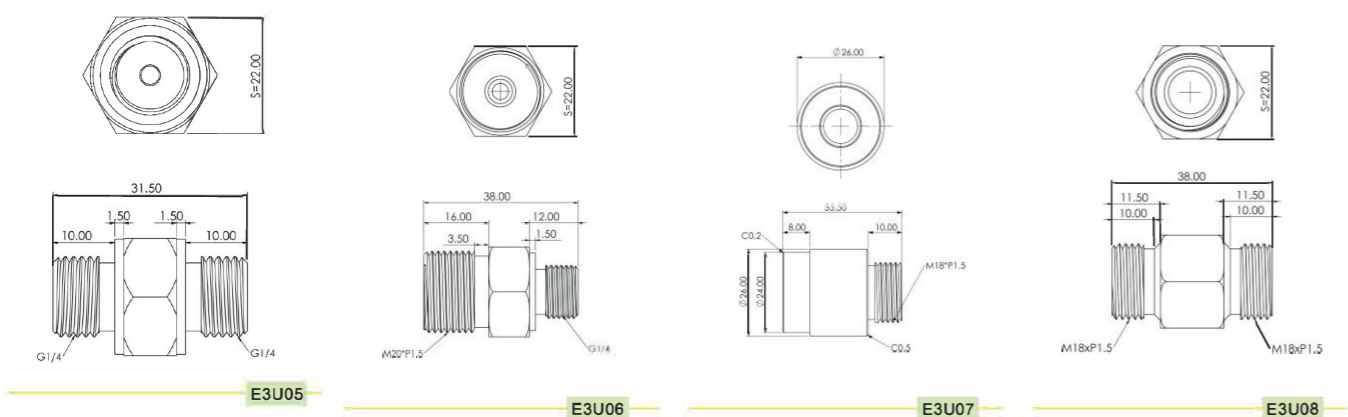
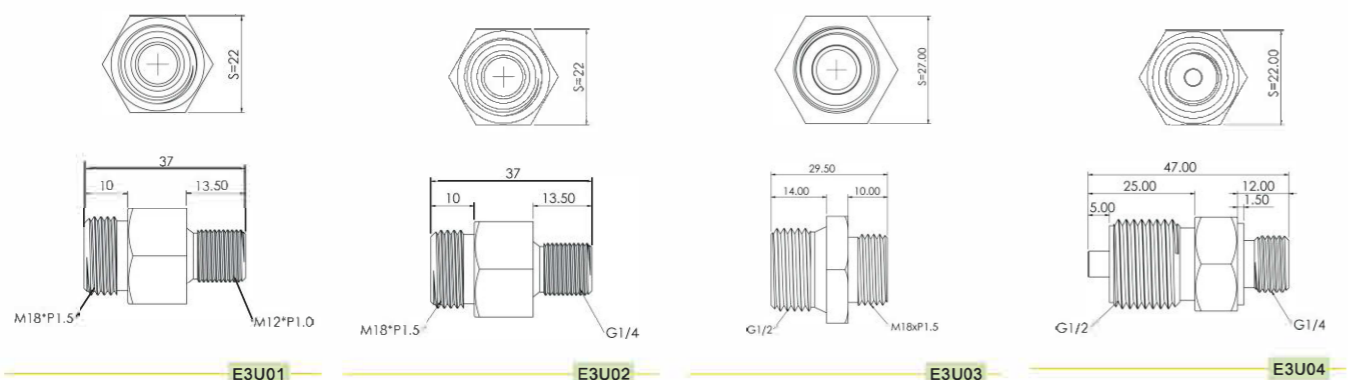

Adapters/sockets/Control unit

