



RANGEFINDER-TYPE MICROWAVE SLAB TRACKING SENSOR

MWS-MT-1 PAT.

MICRO-TRACKER

Penetrates steam
50msec. high speed response

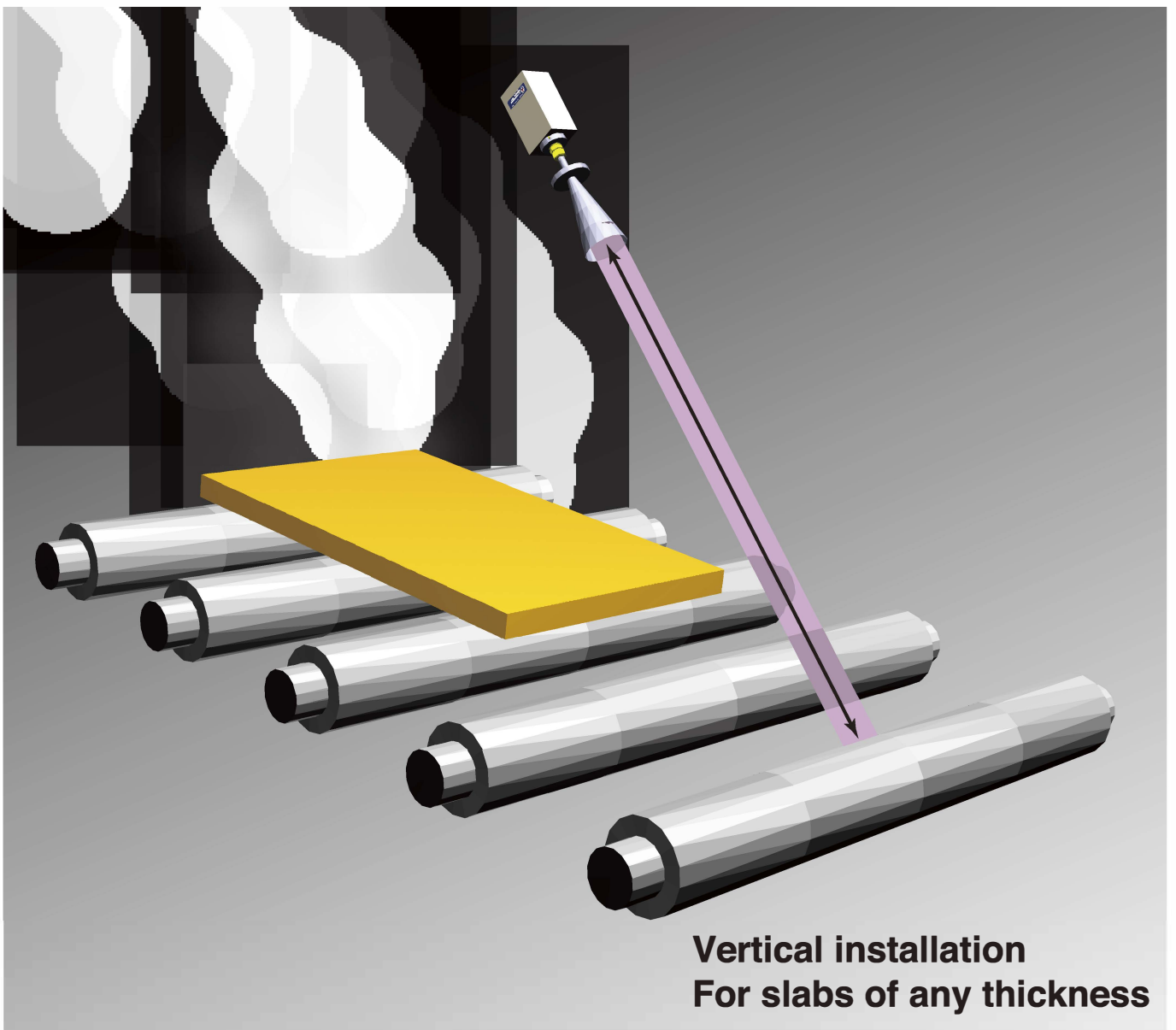

WADECO CO.,LTD.

Unaffected by high temperatures, steam or water!

The MWS-MT-1 type Micro-Tracker has been developed for product tracking in the hot line process. The unit consists of a controller, antenna, and reflector. The MWS-MT-1 is an FM - CW method range finder. The MWS-MT-1 emits microwaves towards the reflector in order to measure the reflection from it.

When a slab interrupts the beam between the antenna and the reflector, the reflection will not be received resulting in the slab presence signal being output. The sensor can be installed either on a diagonal or horizontal axis. Because of the digital detection, this will not be affected by vapor, water running on the slab and/or water spray.

1.

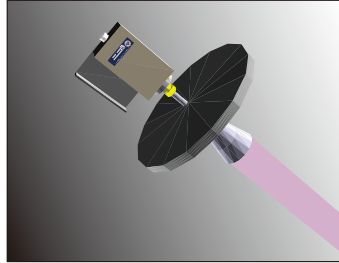

2.

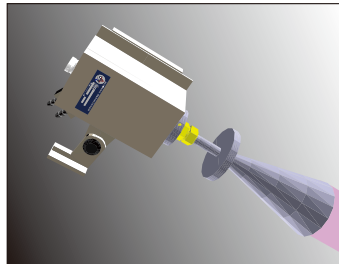

3.

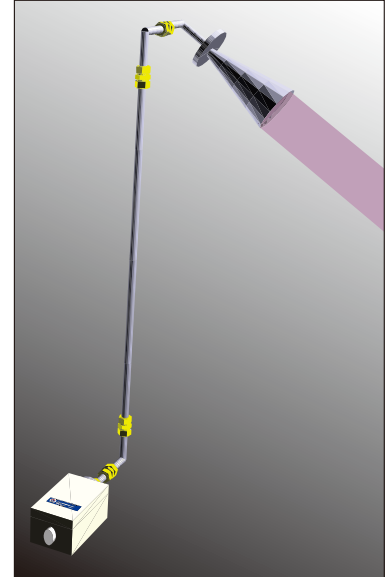

- Options :
1. Heat shield board
 2. Water cooled bed
 3. Waveguide
 4. Ceramic antenna cover (For horizontal installation)

Features

■ Unaffected by adverse conditions

Microwaves are unaffected by heat, vapor, flames, or water running on the slab and water spray.

When countermeasures to heat are required, use the options above.

■ High reliability

The MWS-MT-1 detects the presence or absence of the slab by receiving or not receiving the reflection from the reflector. Because of digital detection, this will not be affected by vapor, water running on the slab or water spray.

■ High speed response time

50msec. update time.

■ No beam slippage

Beam adjustment is easy because the beam is conical-shaped and there will be no errors caused by slippage of the beam.

■ No set-to-set interference

This permits the use of multiple Micro-Trackers in close proximity to each other.

■ Enclosure rating IP65 equivalent

■ New reasonable price

Specifications

Sensor type	MWS-MT-1
Reflector type	CR-200T or roller or flat plate (customer-supplied)
Power supply	AC90V ~ 240V, 50/60Hz
Operating range	1.5 ~ 6m (distance from antenna to reflector)
Frequency & transmission power	GHz. Less than 10mW
Slab presence output	1a solid state relay: DC24V, 0.1A (standard) or 1a relay contacts: AC250V, 2A $\cos\phi=1$ (optional)
Abnormal output	1a solid state relay: DC24V, 0.1A (standard) or 1a relay contacts: AC250V, 2A $\cos\phi=1$ (optional)
Analog output	4 ~ 20mA (0~Received power level from the reflector)
Delay time from power on to function	Approx. 5sec.
Power consumption	10VA
Noise immunity	Pulse noise from noise simulator $\pm 1.5KV$ (normal and common mode)
Ambient operating temperature	-10°C ~ +55°C
Enclosure rating	IP65/NEMA4 equivalent
Construction	Sensor: aluminum diecast (main body), SS400 (base and cover) Reflector: SS400
Color	Grey
Weight	Sensor: Approx. 3.3kg (With large antenna approx. 4.7kg) Reflector: Approx. 1.0kg

Wiring

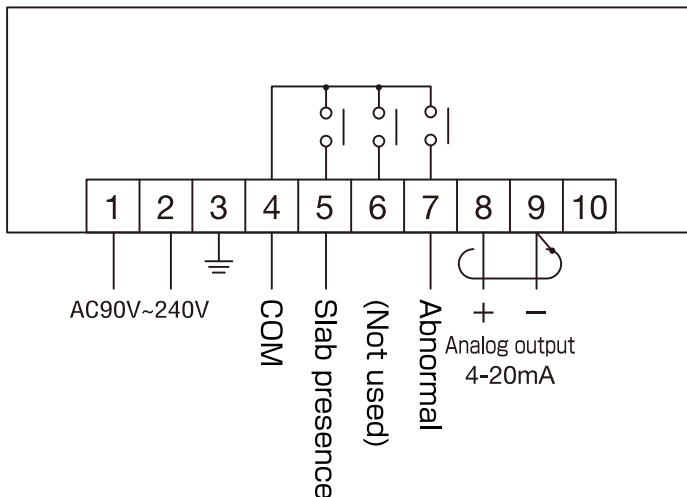

Relay configuration

Purpose		Slab presence	Abnormal
Terminal number		4-5	4-7
Unpowered state		Open	Open
Powered State	Non-detecting state	Closed	Closed
	Detecting state	Open	Open

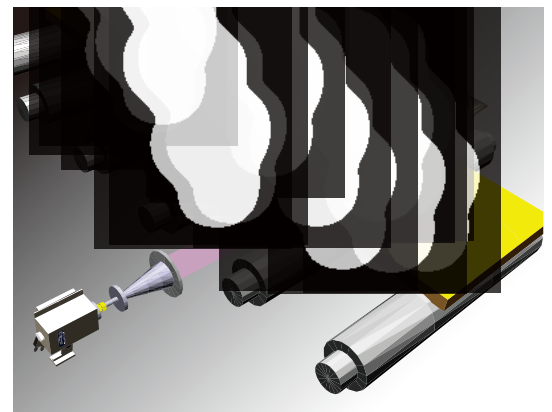

Horizontal installation
For slabs of thickness >20mm



Diagonal installation
For slabs of any thickness

Dimensions

Sensor

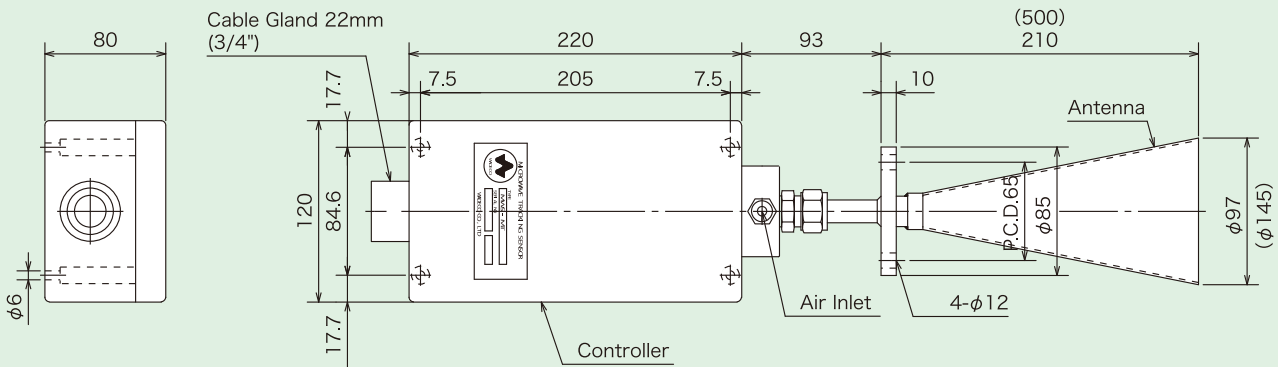

Note: The dimensions in parentheses are for use of a roller as the reflect object.

Reflector

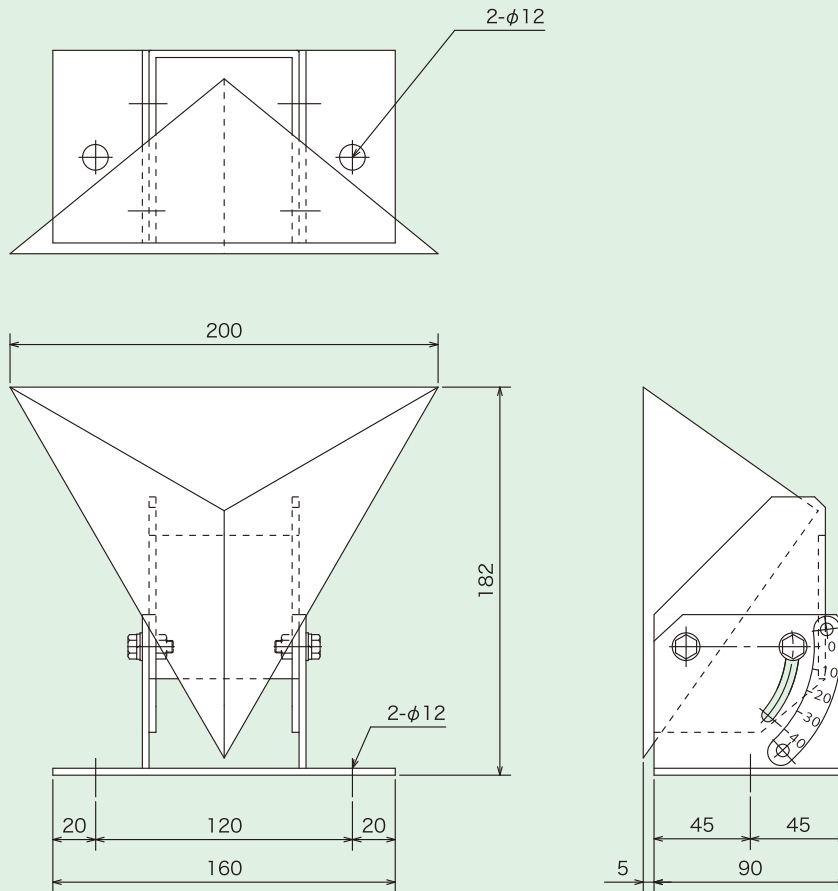

Note: A roller or flat plate (customer-supplied) can be used in place of the reflector.

These specifications may be changed without notice.

ООО "РусАвтоматизация"

454010 г. Челябинск, ул. Гагарина 5, оф. 507
 тел. 8 800 775 09 57 (звонок бесплатный), +7(351)799 54 26, тел./факс +7(351)211 64 57
info@rusautomation.ru; rusавтоматизация.рф; www.rusautomation.ru