

Laser Scanner

Feature

- Activated channel(s) among Ch1 to Ch4
 - Monitoring zone setting
 - Concentrated monitoring zone setting by channel
- Minimum size of the scanning target setting (W×H×L: approx. 5/10/15/20cm per each)
- Parameter setting and real-time monitoring by laser scanner program (atLidar) (Ethernet communication)
- Easy parameter setting via the remote control (RMC-LS, sold separately)
- Emitting property
 - : CLASS1, wavelength band (905nm), max. pulse output power: 75W
- Small size (W125×H80.3×L88mm) for various installation environment
- Meeting KRS (Korean Railway Standard) conditions
- Protection structure: IP67 (IEC standard)



⚠ Please read "Safety Considerations" in the instruction manual before using.



Overview

- The laser scanner measures the time (TOF: Time-of-Flight) between radiation and reflection of the laser pulse and the object. It detects the object distance or obstacles existence.
- The laser scanner utilizes for various environment: obstacles detection sensor for subway platform screen door (PSD), industrial door open/close sensor, security field surveillance sensor, industrial automation field sensor, etc.
- Ethernet communication supports to set parameters and real-time monitoring by PC.

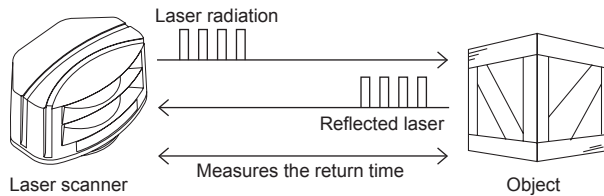

Manual

For the detail information and instructions, please refer to user manual, and be sure to follow cautions written in the technical descriptions (catalog, website).

Visit our website (www.autonics.com) to download manuals.

Laser Scanner Program [atLidar]

- atLidar is the laser scanner program that allows installation of the laser scanner, setting of parameters, and management of monitoring data such as status information.

< System Requirements >

Item	Minimum specifications
System	32bit (×86) or 64bit (×64) processor over 1GHz
Operations	Microsoft Windows 7/8/10
Memory	4GB+
Hard disk	1GB+ of available hard disk space
VGA	Resolution: 1024×768 or higher

< atLidar screen >

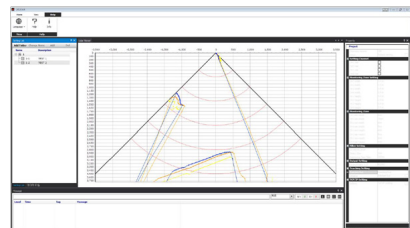

※ Laser scanner is connected with atLidar in Ethernet communication.

※ For initial IP address of the laser scanner, refer to the following table.

In order to connect the laser scanner and PC, set IP address of the PC to that of the laser scanner in same subnet.

Item	Laser scanner	atLidar
Socket	Server	Client
IP address	192.168.0.1	IP address of the user PC
Subnet mask	255.255.255.0	255.255.255.0
Port	8000	—
Gateway	192.168.0.2	192.168.0.2

LSE-4A5R2

■ Specifications

Model	LSE-4A5R2	
Power supply	24VDC $\overline{=}$	
Allowable voltage range	80 to 120% of rated voltage	
Emitting property	Infrared laser	
Emitting property	Laser class	CLASS 1
	Wavelength band	905nm
	Max. pulse output power	75W
Angular resolution	0.4°	
Aperture angle	90°	
Object reflectivity	Min. 2%	
Scanning mode	Motion and presence	
Monitoring zone $\times 1$	0.3×0.3m to 5.6×5.6m (object reflectivity: at approx. 10%)	
Min. size of the scanning target	<ul style="list-style-type: none"> • At detection distance of 3m: approx. W2.1×H2.1×L2.1cm • At detection distance of 5m: approx. W3.5×H3.5×L3.5cm • Object reflectivity: 90% (at Kodak Gray card R-27, white) 	
Power consumption	Max. 8W	
Response time $\times 2$	Typ. 20 to 80ms+monitoring time	
Input	Photocoupler input: 1 (output test mode) <ul style="list-style-type: none"> • [H]: min. 8VDC$\overline{=}$ (max. 30VDC$\overline{=}$), [L]: max. 3VDC • [H] operates as output test mode and outputs obstacle detection output and error status output 	
Output	PhotoMOS relay output: 2 (obstacle detection output, error status output) <ul style="list-style-type: none"> • Galvanic isolation, non-polarity • 30VDC$\overline{=}$ / 24VAC\sim, max. DC80mA (resistive load) • Output resistance: 30Ω • Switching time: t_{ON}=5ms, t_{OFF}=5ms 	
Installation angle $\times 3$	Laser scanner angle	-45°, 0°, 45°
	Bracket rotation angle $\times 4$	-5 to 5°
	Bracket tilt angle	-3 to 3°
Front contamination	Normal operation with max. 30% contamination of one material	
Communication interface $\times 5$	Ethernet	
Life expectancy	Max. 6.8 years (60,000 hours)	
Insulation resistance	Over 5M Ω (at 500VDC megger)	
Dielectric strength	500VAC 50/60Hz for 1 min	
Vibration	Max. 2G (18.7m/s 2)	
Shock	30G/18ms	
Environment	Ambient illumination	Sunlight: max. 100,000lx
	Ambient temperature $\times 6$	-30 to 60°C
	Ambient humidity	0 to 95%RH, storage: 0 to 95%RH
Material	Polycarbonate	
Protection structure	IP67 (IEC standard)	
Cable	Power, I/O	\varnothing 5mm, 8-wire, 5m (AWG 26, core diameter: 0.16mm, number of cores: 7, insulator out diameter: \varnothing 1mm)
	Ethernet	\varnothing 5mm, 4-wire, 3m, shielded cable (AWG 26, core diameter: 0.16mm, number of cores: 7, insulator out diameter: \varnothing 1mm)
Component	Accessory	Bracket, M2.6×L6 Tapping screw (for fixing bracket rotation angle): 2, 3mm allen wrench
	PC program	atLidar (laser scanner program)
Korean Railway Standards	KRS SG 0068	
Approval	CE, 	
Weight $\times 7$	Approx. 0.96kg (approx. 0.58kg)	

$\times 1$: The monitoring zone may be changed by the sensitivity level setting.

$\times 2$: 'Monitoring time' is able to be set with the remote control or atLidar.

$\times 3$: Please refer to '■ Installation'.

$\times 4$: It represents alignment range of laser scanner and is able to be set within the range from -5 to 5° based on the mark line.

$\times 5$: It is used for setting sensor positions, parameters, and monitoring status information.

$\times 6$: Ambient temperature in power supplied status is -30 to 60°C and in power cut status is -10 to 60°C.

$\times 7$: The weight includes packaging. The weight in parenthesis is for unit only.

\times The temperature or humidity mentioned in Environment indicates a non freezing or condensation.

Laser Scanner

■ Dimensions

(unit: mm)

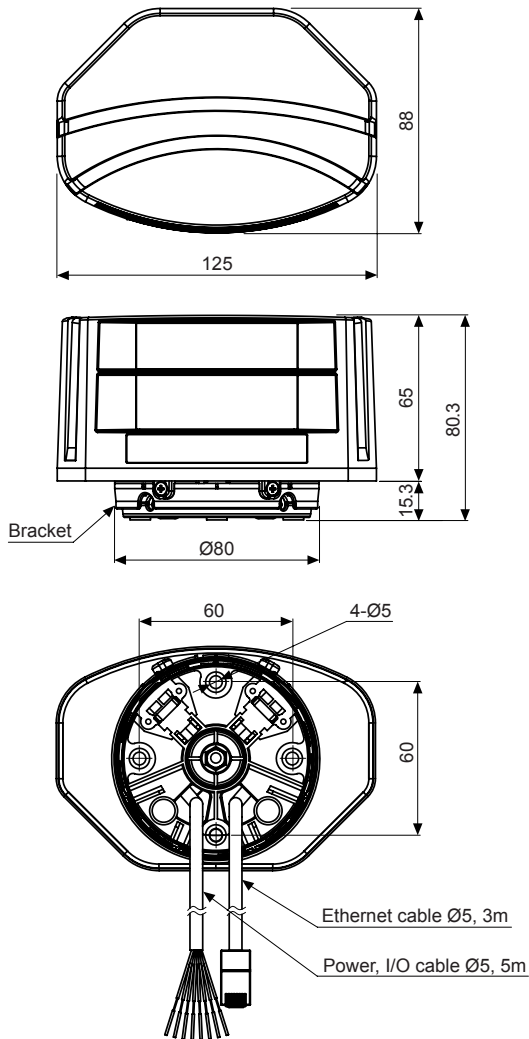

● Bracket

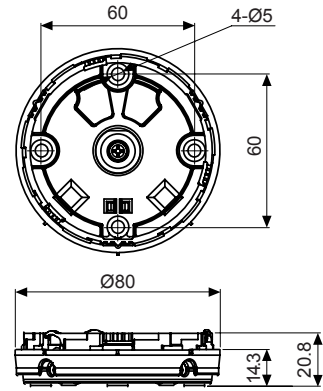

■ Unit Description

◎ Laser scanner (LSE-4A5R2)

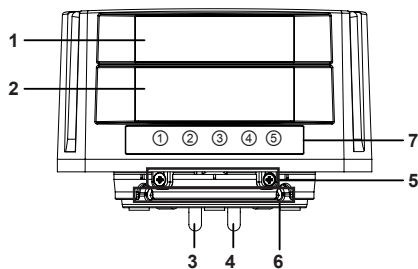

1. Laser emitter
2. Laser receiver
3. Power, I/O cable
4. Ethernet cable
5. Bracket rotation angle fixing part
6. Bracket tilt angle fixing part
7. LED indicator

- ① Ethernet connection indicator (green)
- ② Power indicator (green)
- ③ Remote control operation indicator (green)
- ④ Operation indicator (red)
- ⑤ Error indicator (orange)

※Please refer to 'LED Indicator' for more detailed operation.

LSE-4A5R2

■ Unit Description

◎ Remote control (RMC-LS, sold separately)

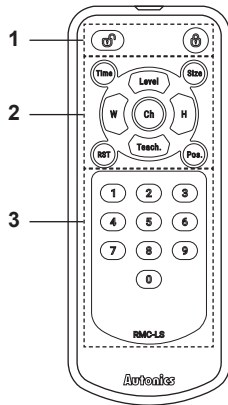

1. LOCK/UN-LOCK

Key	Function	Description
	Unlock	Unlock to press menu key
	Lock	Lock remote control

2. Menu key

Key	Function	Description
	Monitoring time	Outputs after monitoring time when an obstacle is scanned
	Scanning target size	Sets size of the scanning target (approx. 5, 10, 15, 20cm)
	Initialization to factory default	Initializes all settings values to their factory default
	Sensor position	Sets installation position of the laser scanner (view and left, right, center)
	Activated channel	Sets channel (Ch1, Ch2, Ch3, Ch4) to activate
	Sensitivity	Adjusts object scanning sensitivity of the laser scanner
	Width of the monitoring zone or concentrated monitoring zone	Sets width of the monitoring zone or concentrated monitoring zone
	Height of the monitoring zone or concentrated monitoring zone	Sets height of the monitoring zone or concentrated monitoring zone
	Teaching	Familiarizes with the space where the laser scanner will scan

3. Number key: Setting values can be input to each menu, using 0 to 9 number keys.

■ LED Indicator

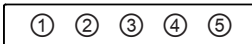

Indicator	Color	Function
① Ethernet connection indicator	Green	Flashes when connected with the PC (Ethernet communication status)
② Power indicator	Green	Flashes when power is supplied
③ Remote control operation indicator	Green	Flashes when key is pressed
④ Operation indicator	Red	Turns on when obstacle is scanned
⑤ Error indicator	Orange	Flashes according to the type of error

◎ LED indicator by situation

(☼: ON, ●: OFF, Ⓛ: Flash)

Indicator	Status				
	①	②	③	④	⑤
Comm. cable connection	Ⓛ	—	—	—	—
Scanning waiting sequence	1	—	●	●	☼
	2	—	●	●	☼
	3	—	●	☼	☼
	4	—	●	Ⓛ (flashing twice in every 0.5 sec)	☼
Scanning Detection	—	Ⓛ (every 1 sec)	●	—	●
Remote control input key waiting	Password	—	●	Ⓛ (every 0.05 sec)	●
	Menu	—	●	Ⓛ (every 0.3 sec)	●
	Number	—	●	Ⓛ (every 0.05 sec)	●
Teaching	—	Ⓛ (flashing in every 1 sec for 35 sec)	●	Ⓛ (flashing in every 1 sec for 35 sec)	●
Output test mode	—	Ⓛ (every 0.05 sec)	●	—	●

※' — ' means nothing to '☼:ON, ●: OFF, Ⓛ: Flash'.

◎ Error indicator

① Voltage error: Repeats "Ⓛ(0.2 sec) > Ⓛ(0.2 sec) > Ⓛ(0.2 sec) > Ⓛ(1 sec) > ●(2 sec)" operation.

② Temperature error: Repeats "Ⓛ(0.2 sec) > Ⓛ(1 sec) > Ⓛ(1 sec) > Ⓛ(1 sec) > ●(2 sec)" operation.

③ Internal error: Flashing of error indicator besides voltage error and temperature error means occurrence of internal error.

※When error occurs, the power indicator (green) and the remote control operation indicator (green) turn OFF and the operation indicator (red) turns ON.

■ Connection Cable

◎ Power, I/O cable

Color	Signal	Function
Brown	+V	24VDC
Blue	GND	0VDC
Yellow	OUT1_A	Obstacle detection output
Green	OUT1_B	
Red	OUT2_A	Error status output
Gray	OUT2_B	
Black	IN_A	Output test mode
White	IN_B	

※The input/output signals can operate in both direction regardless of the polarity.

※When the photocoupler input is not used, do not wire both end of input terminal, or supply power under 3VDC.

◎ Ethernet cable

※The laser scanner communicates with atLidar.

Pin no.	Signal	Pin no.	Signal
1	TX+	5	—
2	TX-	6	RX-
3	RX+	7	—
4	—	8	—

■ Control Input/Output Circuit Diagram

◎ Photocoupler input

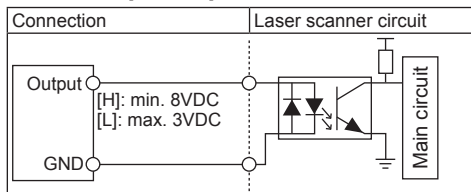

◎ PhotoMOS relay output

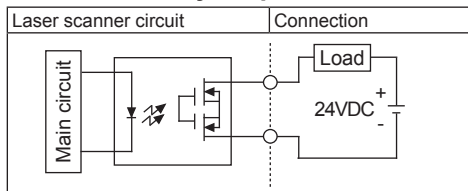

■ Input / Output Status

Input \ Output	OUT1 (obstacle detection output)	OUT2 (error status output)
	ON	ON
OFF	ON : obstacle detection, teaching, error status, scanning ready (approx. 10 sec after supplying power)	ON : error status, scanning ready (approx. 10 sec after supplying power)
	OFF: obstacle non-detection	OFF: Normal status

※When input signal is supplied over 8VDC, it is ON. When it is supplied below 3VDC, it is OFF.

※When OUT1, OUT2 ON output setting is N.O., it is closed. When it is N.C., it is open. When it is Pulse, it is closed.

※When power turns OFF, OUT1, OUT2 are closed.

※For 1 sec right after supplying power, OUT1, OUT2 are closed.

LSE-4A5R2

■ Installation

- ① Fix the bracket at the installation position using four allen wrench bolts (M4, min. 5mm).

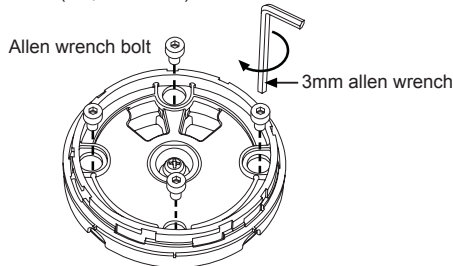

- ② Pass the power, I/O and Ethernet cable through the holes in the bracket.

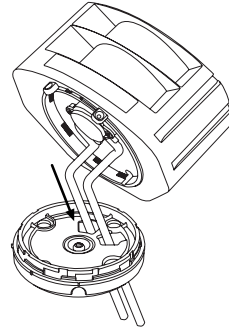

- ③ Align the mark line of the body and one of the three mark lines of the bracket and turn the bracket clockwise to fix. Turn only within the adjustment range.

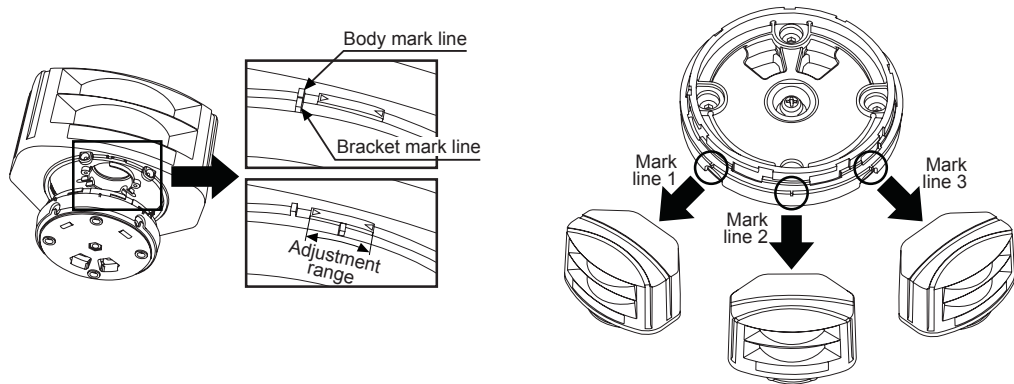

- ④ After setting the bracket rotation angle, fix the bracket and laser scanner with the screwdriver.

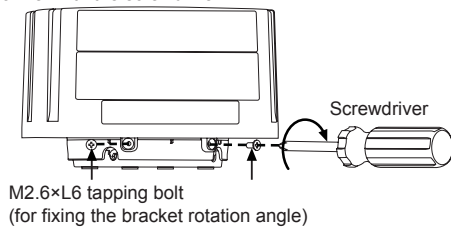

- ⑤ The bracket tilt angle (-3° to 3°) can be adjusted according to the situation of the installed location.

Following image shows the example of rotating the allen wrench to the A direction.

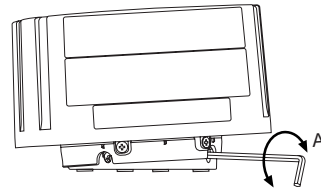

◎ Installing onto an external object

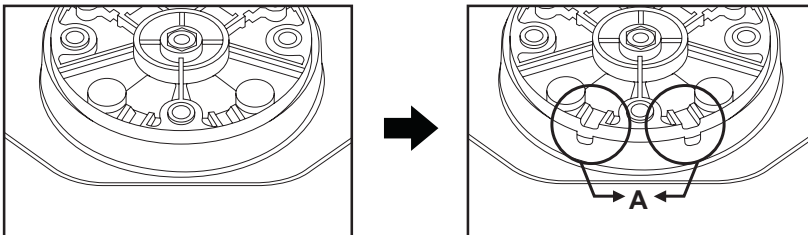

When installing the bracket onto the external object, it has possibility of applying excessive force on the cable due to the lack of space between the cable and the object.
If necessary, cut the A part and place the cable to be stable.

※When cutting the A part, be cautious of personal injury.

■ Function

Functions	Setting method	Remote control (RMC-LS)	Laser scanner program (atLidar)
Sensor position		●	●
Activated channel(s)		●	●
Monitoring zone width (W), height (H)		●	●
Concentrated monitoring zone		●	●
Sensitivity level		●	●
Minimum size of the scanning target		●	●
Monitoring time		●	●
Output		●	●
Teaching		●	●
Password		●	—
Initialization (except password)		●	—
IP initialization		●	—
Setting value initialization (except IP)		—	●

◎ Sensor position

- Set the actual installed laser scanner position: view (top or bottom) and installation (left, right, or center).
- When a user look at the installed laser scanner and the sensor top, set the top view or the sensor bottom, set the bottom view.
- Setting range: Left, Right, Center

Top view, Bottom view

※Factory default: Bottom view, Left installation

※In case of left or right installation, setting value of monitoring zone width (W) and height (H) must be entered.

※In case of center installation, monitoring zone width (W), height (H) is not changeable.

E.g.) Platform screen door (PSD)

- Bottom view, right installation

- Top view, left installation

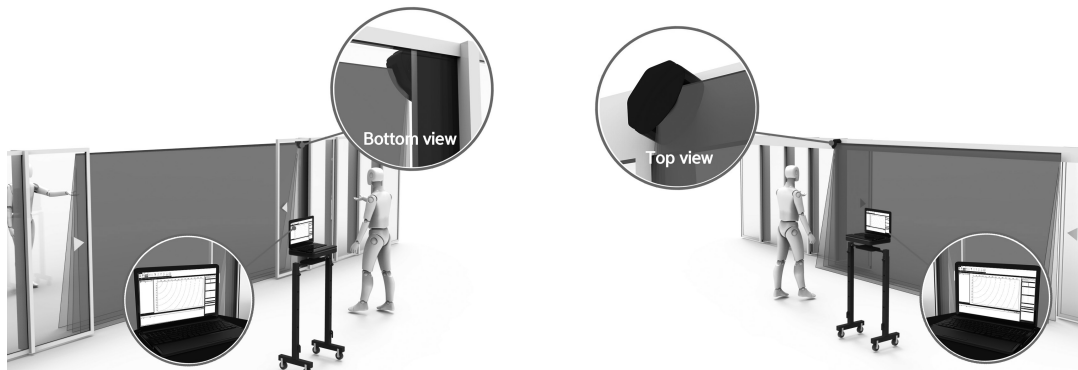

◎ Activated channel(s)

- The laser scanner has 4 channels (Ch1, Ch2, Ch3, Ch4).

- Activate the channel(s) for obstacle detection.

※Factory default: Ch1, Ch2, Ch3, Ch4 activated

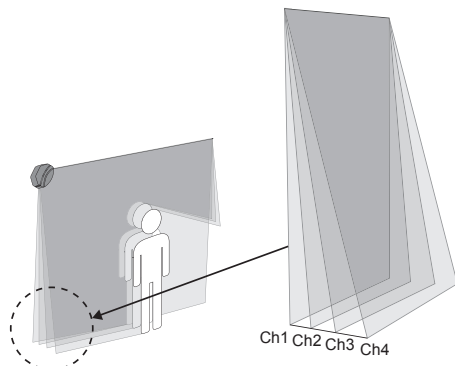

LSE-4A5R2

■ Function

◎ Monitoring zone width (W), height (H)

- Monitoring zone width and height can be set in increments of 0.1m, within the range from 0.5×0.5m to 6×6m.
- ※Factory default: W6.0×H6.0m
- ※In case of center installation, setting value of scanning width (W) and height (H) are fixed to 5.6×5.6m.
- ※Monitoring zone may be different by the reflectivity of obstacles.
- ※For the stable detection, the monitoring zone is set up to 6m.

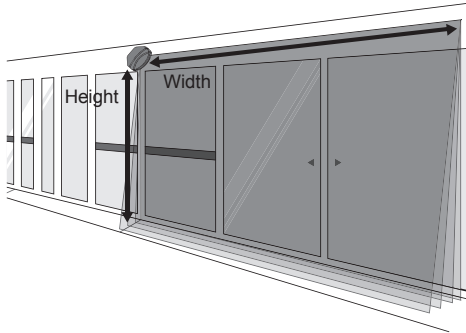

◎ Concentrated monitoring zone

- As shown in the below image, it is possible to set the area where obstacles are scanned intensively except for unnecessary area.
- Height and width are settable from OFF, 10, 20, 30cm individually.
- ※Factory default: OFF
- ※In case of left or right sensor install position, the concentrated zone is available to set.

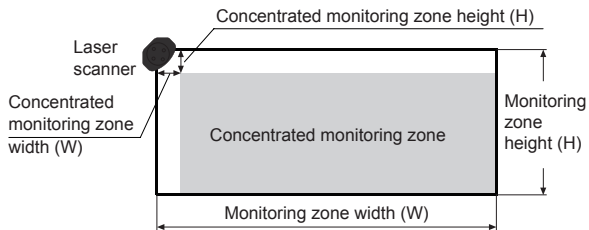

◎ Sensitivity level

- It is able to set the object scanning sensitivity of the laser scanner.
- Setting range is from level 1 (most sensitive, indoor installation) to level 4 (most insensitive, installation in an environment subject to snow or rain).
- ※Factory default: Level 1

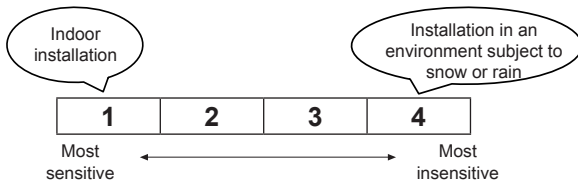

◎ Minimum size of the scanning target

- The minimum size of the scanning target can be set from OFF, approx. 5, 10, 15, 20cm.
- For example, when '5cm' is selected, the object of size over W5×H5×L5cm.
- If the minimum size of the scanning target is set to OFF, the size of the scannable object is as follows.
- 1) At detection distance of 3m: approx. W2.1×H2.1×L2.1cm
- 2) At detection distance of 5m: approx. W3.5×H3.5×L3.5cm
- ※Factory default: Approx. 5cm
- ※The size of the scanning target is approximate.

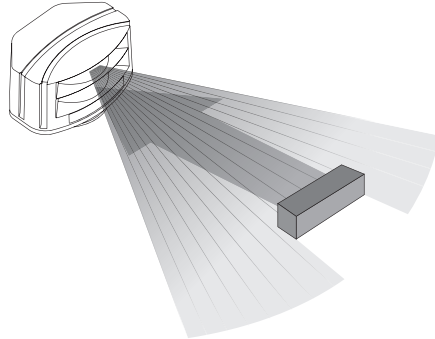

◎ Monitoring time

- When an obstacle is scanned, obstacle detection output occurs after monitoring time.
- By setting monitoring time longer, the laser scanner scans monitoring zone repeatedly and scans obstacles without being affected by snow or rain.
- Setting range is from 0 to 900ms for 100ms unit.
- ※Factory default: 100ms

◎ Output

- The type of obstacle detection output is settable to normally open or normally closed.
- The type of error status output is settable to normally open, normally closed, or pulse.
- ※Factory default: N.O. / N.O.
- ※In case of OUT2 (error status output) as pulse, it repeats open-close operation for 1 sec at the normal operation.
- ※It closes at error status.

	OUT1 (obstacle detection output)	OUT2 (error status output)
N.O./N.O.	Normally open	Normally open
N.O./N.C.	Normally open	Normally closed
N.C./N.O.	Normally closed	Normally open
N.C./N.C.	Normally closed	Normally closed
N.O./Pulse	Normally open	Pulse
N.C./Pulse	Normally closed	Pulse

■ Function

◎ Teaching

- This function is to familiarize the space which is set by the monitoring zone width (W) and height (H) in advance.
- Objects in the space at moment of teaching are not regarded as obstacles.
- When the environment is changed or some objects are removed or added in the space, newly operate teaching.
- Teaching takes 35 seconds.
- ※For re-install the unit teaching already at no teaching required area, initial the unit. Do not re-teaching it.
- ※Operate teaching in the environment free from snow, rain, fog, hail, or mutual interference of another laser scanner.

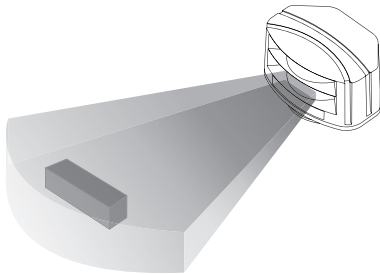

◎ Password

- When entering the (P) key of the remote control, only the user who entered the right password changes the parameter settings of sensor position, monitoring zone width (W), height (H), etc.
- When setting password, the password function is activated.
- ※Password setting range: 0000 to 9999
- ※When losing the set password, re-supply the power and set the password again in 10 minutes.
- ※Please use the password function for preventing mutual interference of several units or malfunction.
- ※If any key is not entered for 1 sec after entering the (P) key, the laser scanner is scanning mode.

◎ Factory default initialization

- The laser scanner's settings: sensor position, monitoring zone width (W), height (H), activated channel(s), etc. and IP, except password initializes as factory default.

◎ IP initialization

- The laser scanner's IP address initializes as factory default.

◎ Setting initialization

- The laser scanner's settings: sensor position, monitoring zone width (W), height (H), activated channel(s), etc. except IP as factory default.



■ Troubleshooting

※Check the normal operation status of LSE-4A5R2 periodically.

Error	Causes	Troubleshooting
Power indicator (green) OFF	Supply the power voltage.	Check the rated power supply.
	Wrong polarity connection of power supply	Check the Connection diagram when wiring the unit.
Error indicator (orange) flashing	Voltage error	Use the unit within the rated voltage.
	Temperature error	Use the unit within the specified ambient temperature.
	Inside error	Contact the seller.
Relay output is ON without objects within teaching area	Detection by external environment (snow, rain, or hail, etc.)	Change the settings: sensitivity level, scanning target size, monitoring time.
	There is the equipment which generates strong magnetic force or high frequency noise (motor, generator, or power cable, etc.) near the laser scanner.	Install the laser scanner away from the equipment which generates strong magnetic force or high frequency noise.
Laser scanner does not react for remote control operation.	The batteries' life cycle of the remote control is over.	Change the batteries.
	Wrong direction control of the remote control	Operate the remote control towards the near laser scanner.
After pressing the (P) key of remote control, the setting is not available.	Password incorrect.	Turn OFF the power and re-supply the power, the password is available to reset.
		Contact the seller.
atLidar (PC program) and the laser scanner does not connected.	LAN connector connection error	Check the PC and LAN connector connection part.
	IP address is not same.	Check the IP address of the laser scanner and the user PC.
	IP address of the laser scanner and wireless router is same.	Set the wireless network (Wifi) to "Disable" in the network settings of the Windows operating system.

LSE-4A5R2

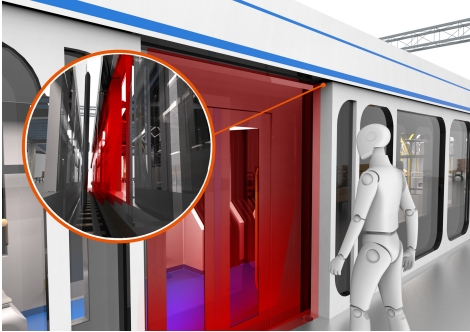
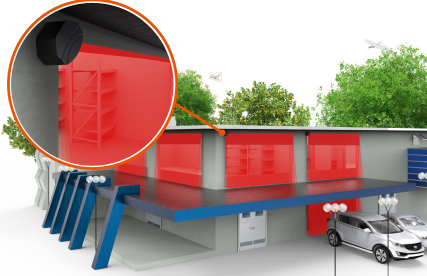
■ Applications

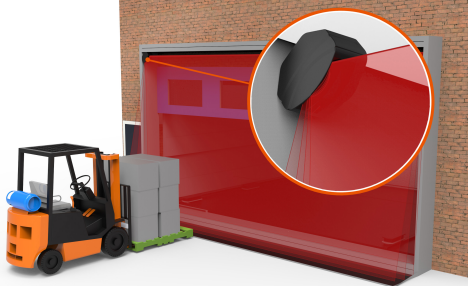
<p>Passenger presence / absence detection of subway platform screen door (PSD)</p>	<p>Vehicle classification and detection through highway tollgate</p>
	
<p>Security of store door</p>	<p>Security of private house or villa door</p>
	
<p>Obstacle detection in logistics center</p>	<p>Prevention of collision by detection of forklift and industrial vehicle entry</p>
	
<p>Parking lot barrier gate opening/closing</p>	
	

■ Cautions during Use

- Follow instructions in 'Cautions during Use'. Otherwise, it may cause unexpected accidents.
- 24VDC power supply should be insulated and limited voltage/current or Class 2, SELV power supply device.
- After supplying power, the sensor performs self-check for about 10 sec. When self-checking, error occurrence, remote control setting, and teaching, the laser scanner outputs the same as it sensed obstacle.
- Mutual optical interference between laser scanners and photoelectric sensors may result in malfunction.
- Mutual optical interference between laser scanners may result in malfunction.
- Objects can not be scanned when covering the front cover of the laser scanner.
- When the laser scanner is moved to another position, use it after re-teaching (Teach-in).
- Do not drop the unit. It may cause malfunction.
- Installing the laser scanner in the place where smoke, fog, dust, or corrosion is heavy may result in malfunction.
- When installing the laser scanner outdoors, take protective measures. Otherwise, it may result in product damage.
- Keep away from high voltage lines or power lines to prevent inductive noise. In case of installing power line and input signal line closely, use line filter or varistor at power line and shield wire at input signal line.
Do not use the laser scanner near the equipment which generates strong magnetic force or high frequency noise.
- Cover with shields, hoods, or etc. to prevent direct incidence of strong light (direct rays of sunlight, incandescent) into the laser scanner beam spread angle.
- When fastening the laser scanner with the bracket, align with the mark line.
- When mounting the bracket onto an external object, remove the wire fixture so that the wire of the laser scanner is not pressed.
- Fix the laser scanner in position with the fixing screw. Vibration may result in malfunction.
- When IP address of the laser scanner and wireless router is same, the communication does not connected.
Set the wireless network (Wifi) to "Disable" in the network settings of the Windows operating system.
- This unit may be used in the following environments.
 - ① Indoors/Outdoors (in the environment condition rated in 'Specifications')
 - ② Altitude max. 2,000m
 - ③ Pollution degree 2
 - ④ Installation category II