

OMX 102UNI

PROGRAMMABLE UNIVERSAL TRANSMITTER

DC VOLTMETER/AMMETER
PROCESS MONITOR
OHMMETER
THERMOMETER FOR PT/NI/CU
THERMOMETER FOR THERMOCOUPLES
DISPLAYS FOR LINEAR POTENTIOMETERS

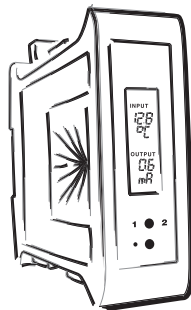



SAFETY INSTRUCTIONS

Please, read the enclosed safety instructions carefully and observe them!
These instruments should be safeguarded by isolated or common fuses (breakers)
For safety information the EN 61 010-1 + A2 standard must be observed.
This instrument is not explosion-safe!

TECHNICAL DATA

Measuring instruments of the DMX 102 series conform to the European regulation 89/336/EWG.

The instruments are up to the following European standards:

EN 61010-1 Electrical safety

EN 61326-1 Electronic measuring, control and laboratory devices – Requirements for EMC "Industrial use"

Seismic capacity:

IEC 980: 1993, čl. 6

The instruments are applicable for unlimited use in agricultural and industrial areas.

CONNECTION

Supply of energy from the main line has to be isolated from the measuring leads.



1. CONTENTS	3
2. INSTRUMENT DESCRIPTION	4
3. INSTRUMENT CONNECTION	6
Measuring ranges	6
Instrument connection	7
Recommended connection of sensors	8
4. INSTRUMENT SETTING	10
Symbols used in the instructions	12
Setting the DP and the () sign	12
Control keys function	13
Setting/permitting items into 'USER' menu	13
5. SETTING "LIGHT" MENU	14
5.0 Description "LIGHT" menu	15
Setting input - Type "DC"	18
Setting input - Type "102DC"	20
Setting input - Type "PM"	22
Setting input - Type "OHM"	24
Setting input - Type "RTD - Pt"	26
Setting input - Type "RTD - Cu"	28
Setting input - Type "RTD - Ni"	30
Setting input - Type "T/C"	32
Setting input - Type "DU"	34
Setting Limits	36
Setting analog output	37
Selection of programming menu „LIGHT"/„PROFI"	38
Restoration of manufacture setting	38
Calibration - input range (DU)	39
Selection of instrument menu language version	40
Setting new access password	40
Instrument identification	41
6. SETTING "PROFI" MENU	42
6.0 Description of "PROFI" menu	42
6.1 "PROFI" menu - INPUT	
6.1.1 Resetting internal values	44
6.1.2 Setting measuring type, range, mode, rate	45
6.1.3 Setting the Real Time	53
6.1.4 External input function selection	54
6.2 "PROFI" menu - CHANNEL	
6.2.1 Setting measuring parameters (projection, filters, decimal point, description)	56
6.2.2 Setting mathematic functions	60
6.2.3 Selection of evaluation of min/max. value	63
6.3 "PROFI" menu - OUTPUT	
6.3.1 Setting of excitation level	64
6.3.2 Setting data logging	64
6.3.3 Setting Limits	66
6.3.4 Setting data output	70
6.3.5 Setting analog output	72
6.3.6 Setting of display backlight	74
6.4 "PROFI" menu - SERVIS	
6.4.1 Selection of programming menu „LIGHT"/„PROFI"	76
6.4.2 Restoration of manufacture setting	77
6.4.3 Calibration - input range (DU)	78
6.4.4 Selection of instrument menu language version	78
6.4.5 Setting new access password	78
6.4.6 Instrument identification	79
7. SETTING ITEMS INTO "USER" MENU	80
8. METHOD OF MEASURING OF THE COLD JUNCTION	82
9. ERROR STATEMENTS	83
10. DATA PROTOCOL	84
11. TABLE OF SYMBOLS	86
12. TECHNICAL DATA	88
13. INSTRUMENT DIMENSIONS AND INSTALATION ...	90
14. CERTIFICATE OF GUARANTEE	91

2. INSTRUMENT DESCRIPTION



2.1 DESCRIPTION

The OMX 102 model range are DIN rail mountable programmable transmitters designed with the utmost versatility and user comfort in mind whilst keeping the cost at a favourable level. The OMX 102 various executions are UNI, DC, PWR, UQC and T. As a standard the instrument is fitted with a backlit LCD display which projects measured values and configuration settings. OMX 102UNI is a multifunctional instrument with 8 possible input configurations easily adjustable in the instrument's menu. The instrument is based on an 32-bit microcontroller, 24-bit A/D and 16-bit D/A converters, which ensures good accuracy, stability and easy operation of the instrument.

TYPES AND RANGES

UNI	up to 2 individual inputs DC: $\pm 30/\pm 60/1000$ mV; $\pm 20/\pm 40/\pm 80$ V; $\pm 90/\pm 180$ mA PM: $\pm 5/\pm 20$ mA/4...20 mA; $\pm 2/\pm 5/\pm 10$ V OHM: 0...100/300 Ω /0...1.5/3/24/30 k Ω RTD-Pt: Pt 50/100/500/1000 RTD-Cu: Cu 50/100 RTD-Ni: Ni 1 000/10 000 T/C: J/K/T/E/B/S/R/N/L DU: Linear potentiometer (min. 500 Ω)
DC	$\pm 1/\pm 5$ A; $\pm 25/\pm 50/\pm 100/\pm 200/\pm 400$ V

PROGRAMMABLE PROJECTION

Selection:	of type of input and measuring range
Measuring range:	adjustable
Setting:	manual, optional projection on the display may be set in the menu for both limit values of the input signal, e.g. input 0...20 mA > 0...150
Projection:	-99M...999M

ANALOG OUTPUTS

Type:	isolated, programmable with resolution of max. 16 bit, rate < 1 ms
Quantity:	up to 2
Range:	0...2/5/10 V, ± 10 V, 0...5 mA, 0/4...20 mA, 0,2...2 200 Hz

COMPENSATION

of conduct:	in the menu it is possible to perform compensation for 2-wire connection
of conduct in probe:	internal connection (conduct resistance in measuring head)
of CJC (T/C):	manual or automatic, in the menu it is possible to perform selection of the type of thermocouple and compensation of cold junctions, which is adjustable or automatic (temperature at the brackets)

LINEARIZATION

Linearization:*	by linear interpolation in 50 points (solely via OM Link)
-----------------	---

DIGITAL FILTERS

Floating average:	from 2...30 measurements
Exponen. average:	from 2...100 measurements
Arithmetic average:	from 2...100 measurements
Rounding:	setting the projection step for display

* only for types DC, PM, DU

MATHEMATIC FUCTIONS

Min/max. value:	registration of min./max. value reached during measurement
Tare:	designed to reset display upon non-zero input signal
Fixed Tare:	pre-set tare, fixed
Peak value:	the display shows only max. or min. value
Mat. operations:	polynome, $1/x$, logarithm, exponential, power, root, sin x and mathematic operatin between input - total and divide

EXTERNAL CONTROL

Lock:	control keys blocking
Hold:	display/instrument blocking
Tare:	tare activation/resetting tare to zero
Resetting MM:	resetting min/max value
Memory:	data storage into instrument memory
Swap:	switching (swapping) between active inputs/outputs (where available)

2.2 OPERATION

The instrument is set and controlled by two control keys located on the front panel. All programmable settings of the instrument are performed in three adjusting modes:

LIGHT Simple programming menu

- contains solely items necessary for instrument setting and is protected by optional number code

PROFI Complete programming menu

- contains complete instrument menu and is protected by optional number code

USER User programming menu

- may contain arbitrary items selected from the programming menu (LIGHT/PROFI), which determine the right (see or change)
- acces without password

All programmable parameters are stored in the EEPROM memory (they hold even after the instrument is switched off).

O.M.LINK Complete instrument operation and setting may be performed via OM Link communication interface, which is a standard equipment of all instruments.

The operation program is freely accessible (www.orbit.merret.eu) and the only requirement is the purchase of OML cable to connect the instrument to PC. It is manufactured in version RS 232 and USB and is compatible with all ORBIT MERRET instruments. Another option for connection is with the aid of data output RS 232, RS 485, LAN and USB (without the need of the OML cable).

The program OM LINK in „Basic“ version will enable you to connect one instrument with the option of visualization and archiving in PC. The OM Link „Standard“ version has no limitation of the number of instruments connected.

2.3 OPTIONS

Excitation is suitable for supplying power to sensors and transmitters. It has a galvanic separation.

Comparators are assigned to monitor two limit values with relay output. The user may select limits regime: LIMIT/DOSING/FROM-TD. The limits have adjustable hysteresis within the full range of the display as well as selectable delay. Reaching the preset limits is signalled by LED and simultaneously by the switch-on of the relevant relay.

Data outputs jare for their rate and accuracy suitable for transmission of the measured data for further projection or directly into the control systems. We offer an isolated RS232 and RS485 with the ASCII/Mesbus/MODBUS/PROFIBUS protocol, CAN and LAN.

Measured data record is an internal time control of data collection. It is suitable where it is necessary to register measured values. Two modes may be used. FAST is designed for fast storage (40 records/s) of all measured values up to 8 000 records. Second mode is RTC, where data record is governed by Real Time with data storage in a selected time segment and cycle. Up to 250 000 values may be stored in the instrument memory. Data transmiss ion into PC via serial interface USB, RS 232/485 and OM Link.

3. INSTRUMENT CONNECTION



The instrument supply leads should not be in proximity of the incoming low-potential signals.

Contactors, motors with larger input power should not be in proximity of the instrument.

The leads into the instrument input (measured quantity) should be in sufficient distance from all power leads and appliances. Provided this cannot be secured it is necessary to use shielded leads with connection to ground (bracket E).

The instruments are tested in compliance with standards for use in industrial area, yet we recommend to abide by the above mentioned principles.

MEASURING RANGES

TYPE	INPUT 1	INPUT 2	INPUT 3	INPUT 4	INPUT 5
DC	$\pm 20/\pm 40/\pm 80$ V		$\pm 30/\pm 60/\pm 1000$ mV		$\pm 90/\pm 180$ mA
PM	$\pm 2/\pm 5/\pm 10$ V				$\pm 5/20/4...20$ mA
T/C			J/K/T/E/B/S/R/N/L		
OHM			0...100/300 Ω /0...15/3/24/30 k Ω		
RTD-Pt			Pt 50/100/500/1 000		
RTD-Cu			Cu 50/100		
RTD-Ni			Ni 1 000/10 000		
DU			Linear potentiometer (min. 500 Ω)		

OMX 102DC

TYPE	INPUT 1	INPUT 2	INPUT 3	INPUT 4	INPUT 5
DC	$\pm 25/\pm 50/\pm 100$ V $\pm 200/\pm 400$ V Channel 1				0...1/5 A Channel 2

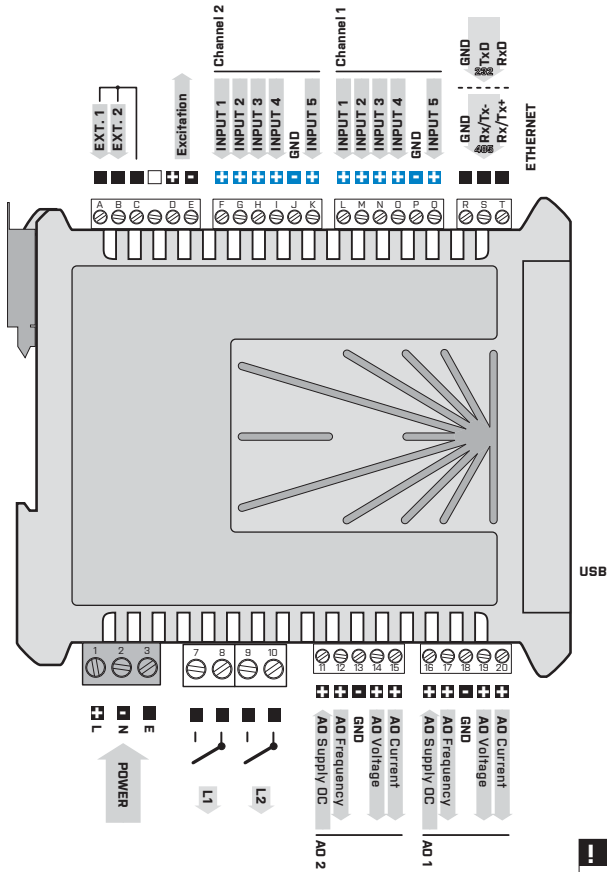

DU



T/C

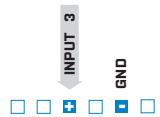

OHM, RTD, Ni, Cu

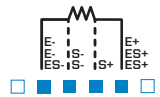

!
Ground wire must be connected to terminal „E“ at all times!

!
When using **RTD** or **OHM** inputs in 2-wire or 3-wire connection, it is essential connect unused inputs on the terminal board (**M+N/O+P** or **O+P**). The same applies to Channel 2.

!
Supply to open collector [DC] for frequency output is max. 40 V (internal resistor 5kΩ)

! **USB**
USB and OM Link are galvanic connected with input!
When input wires are connected, a galvanic isolated USB cable **MUST** be used.
RISK OF DAMAGING YOUR COMPUTER

3. INSTRUMENT CONNECTION



Example connection of a 2-wire sensor with current signal output powered by instrument's excitation

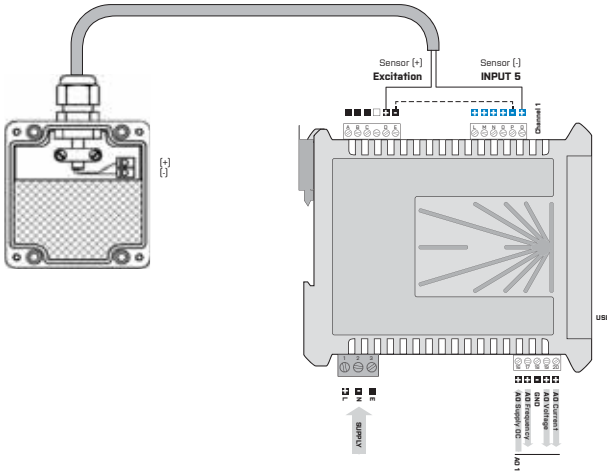

Example connection of a 3-wire sensor with current signal output powered by instrument's excitation

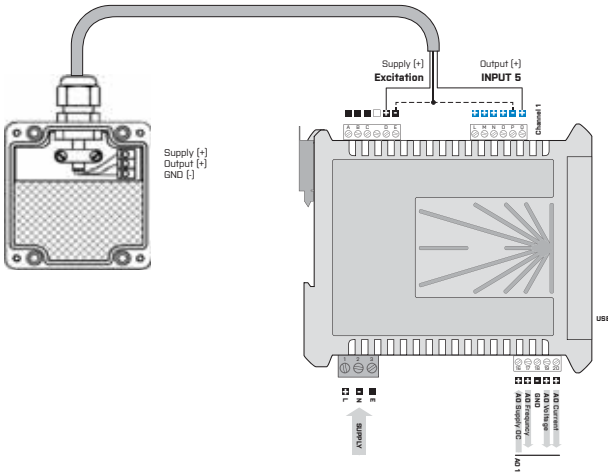

Example connection of 3-wire sensor with voltage signal output powered by instrument's excitation

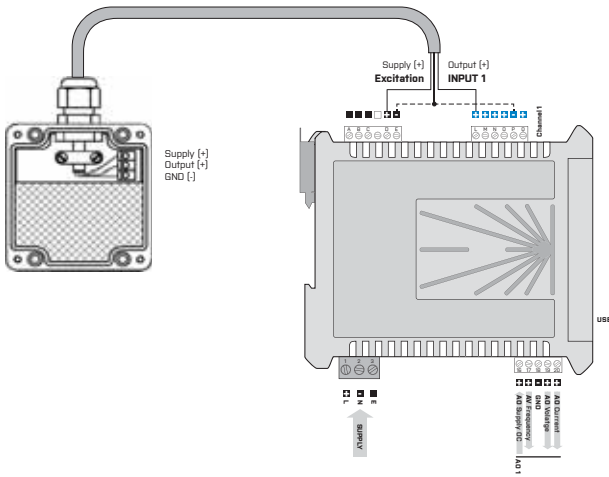



SETTING **PROFI**

For expert users

Complete instrument menu

Access is password protected

Possibility to arrange items of the **USER MENU**

Tree menu structure

SETTING **LIGHT**

For trained users

Only items necessary for instrument setting

Access is password protected

Possibility to arrange items of the **USER MENU**

Linear menu structure

SETTING **USER**

For user operation

Menu items are set by the user (Profi/Light) as per request

Access is not password protected

Optional menu structure either tree (PROFI) or linear (LIGHT)

4.1 SETTING

The instrument is set and controlled by two control keys located on the front panel. All programmable settings of the instrument are performed in three adjusting modes:

- LIGHT** **Simple programming menu**
- contains solely items necessary for instrument setting and is protected by optional number code
- PROFI** **Complete programming menu**
- contains complete instrument menu and is protected by optional number code
- USER** **User programming menu**
- may contain arbitrary items selected from the programming menu (LIGHT/PROFI), which determine the right (see or change)
- acces without password

All programmable parameters are stored in the EEPROM memory (they hold even after the instrument is switched off).

Complete instrument operation and setting may be performed via QM Link communication interface, which is a standard equipment of all instruments.

The operation program is freely accessible (www.orbit.merret.eu) and the only requirement is the purchase of QML cable to connect the instrument to PC. It is manufactured in version RS 232 and USB and is compatible with all ORBIT MERRET instruments. Another option for connection is with the aid of data output RS 232 or RS 485 (without the need of the QML cable).

4. INSTRUMENT SETTING

Setting and controlling the instrument is performed by means of two control keys located on the front panel. With the aid of these keys it is possible to browse through the operation menu and to select and set required values.

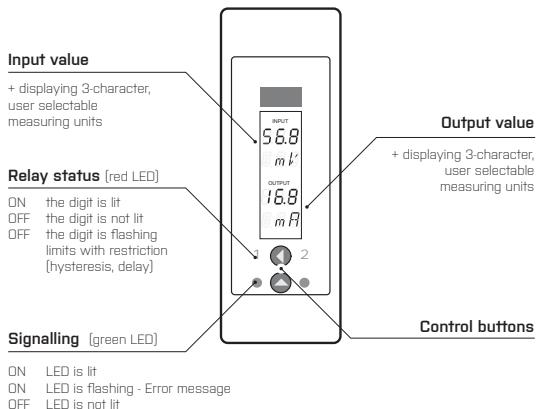

Symbols used in the instructions

DC PM DU OHM RTD T/C Indicates the setting for given type of instrument

DEF values preset from manufacture

 symbol indicates a flashing light (symbol)

MIN inverted triangle indicates the item that can be placed in USER menu

 broken line indicates a dynamic item, i.e. it is displayed only in particular selection/version

 after pressing the key the set value will not be stored

 after pressing the key the set value will be stored

 **30** continues on page 30

Setting the decimal point and the minus sign

DECIMAL POINT

Its selection in the setting mode is performed by control key **1** with transition behind the highest decade, when the data starts flashing. Positioning is performed by **1**. For projection of value exceeding 999 the suffix may be set „m“ - 0,001, „k“ - 1000 or „M“ - 100 000

THE MINUS SIGN

Setting the minus sign is performed by control key **1** on the higher decade. When editing the item, figures change in numeric row 0,1,..9,-,0,1

Control keys functions

KEY	MEASUREMENT	MENU	SETTING NUMBERS/SELECTION
	value of tare (DC, PM) measured resistance (RTD) cold junction compensation (T/C) swapping inputs	back to previous level	move to higher decade
	Tare/Resetting	move to next item	move up
+		confirm selection	confirm setting/selection
+ < 2 s	access into LIGHT menu		
+ > 2 s	direct access into PROF1 menu		
	access into USER menu		

Setting items into „USER“ menu

- in **LIGHT** or **PROF1** menu
- no items permitted in **USER** menu from manufacture
- on items marked by inverted triangle

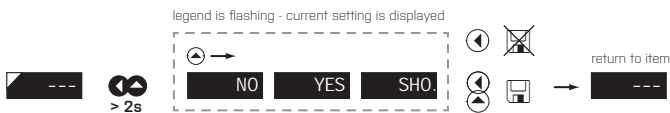
USER

NO	item will not be displayed in USER menu
YES	item will be displayed in USER menu with the option of setting
SHO.	item will be solely displayed in USER menu



SETTING LIGHT

For trained users

Only items necessary for instrument setting

Access is password protected

Possibility to arrange items of the **USER MENU**

Linear menu structure

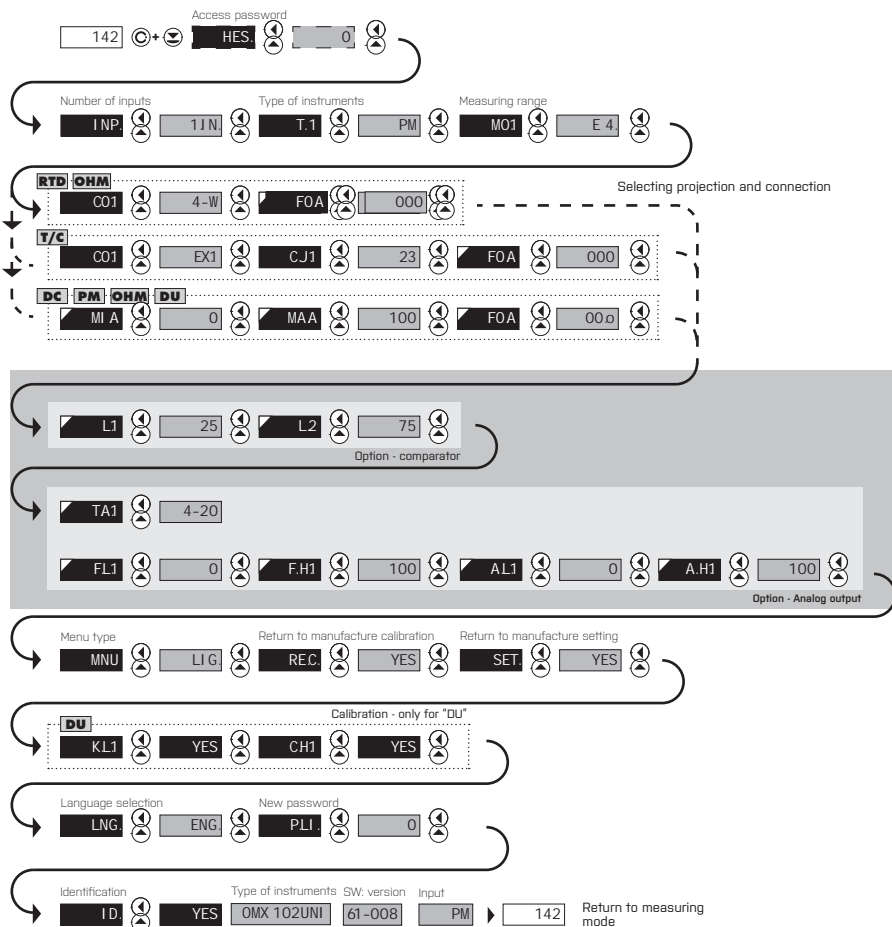

Preset from manufacture

Password	"0"
Menu	LIGHT
USER menu	off
Setting the items	DEF

!
Upon delay exceeding 60 s the programming mode is automatically discontinued and the instrument itself restores the measuring mode

5. SETTING LIGHT

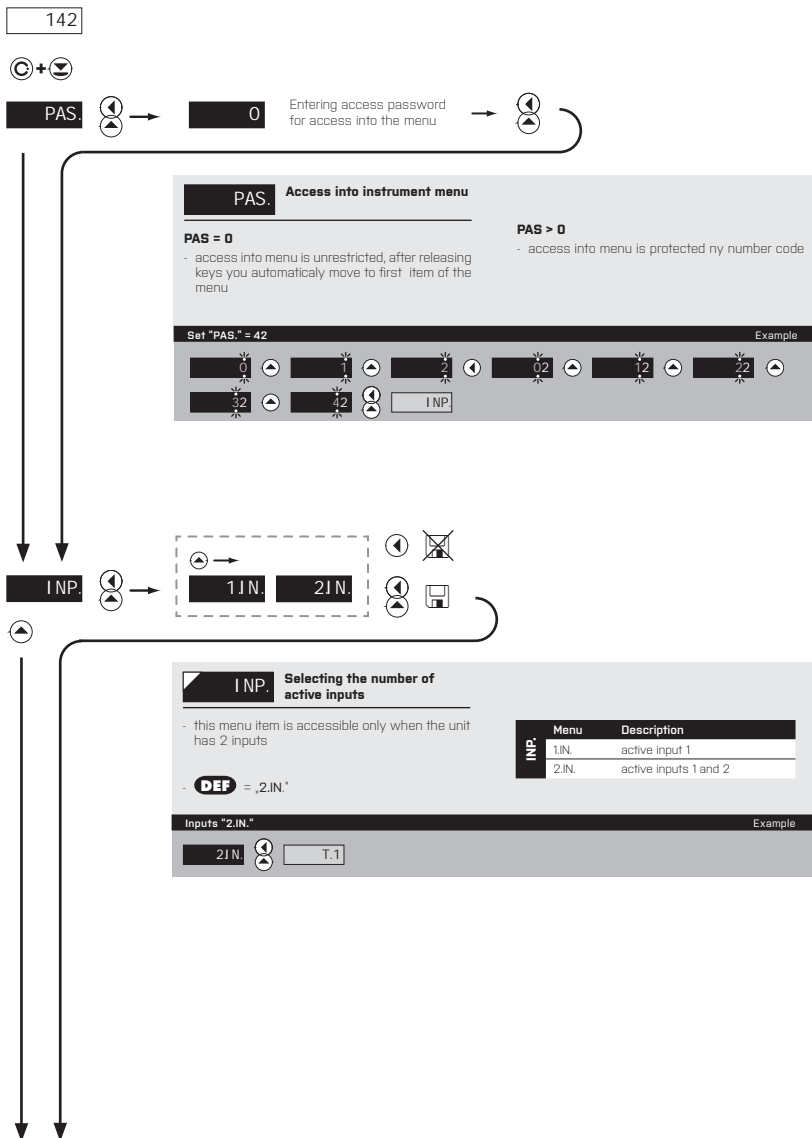

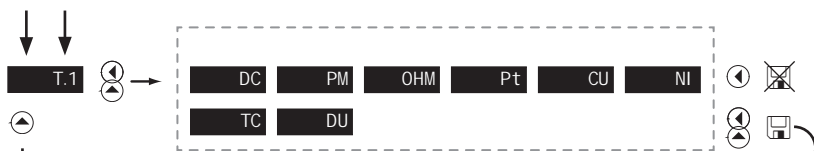

T.1

Selection of the type of instrument

- primary selection of the type of instrument
- performs default setting **DEF** of values from manufacture, incl. calibration
- **DEF** = „PM“

	Menu	Type of instrument
T.1	DC	DC voltmeter
	PM	Process monitor
	DHM	Dhmmeter
	RTD-Pt	Thermometer for sensors Pt
	RTD-Ni	Thermometer for sensors Ni
	TC	Thermometer for thermocouples
	DU	Display for lin. potentiometer
	RTD-Cu	Thermometer for sensors Cu

Type "PM"

Example

PM

↺

M01

Type DC		18
Type 102DC		20
Type PM		22
Type OHM		24
Type Pt		26
Type Cu		28
Type Ni		30
Type T/C		32
Type Du		34

5. SETTING LIGHT

MEASURING MODE > DC

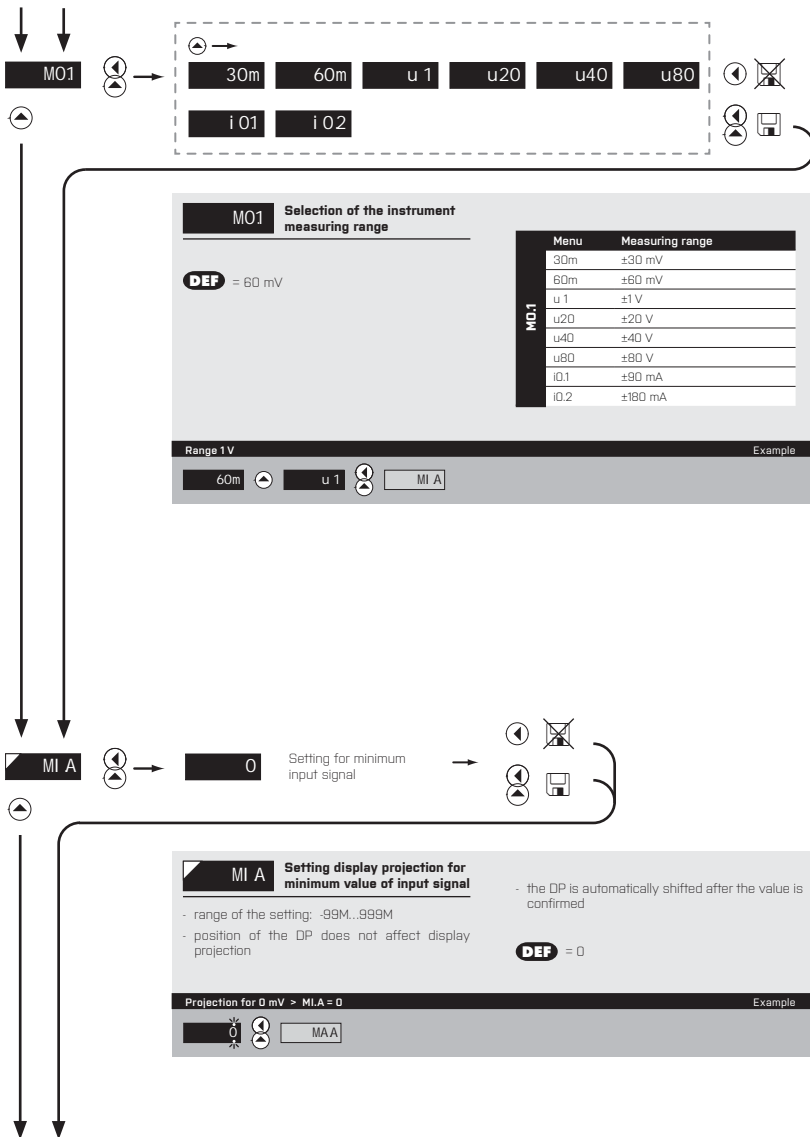



MAA **Setting display projection for maximum value of input signal**

- the DP is automatically shifted after the value is confirmed
- range of the setting: :99M...999M
- position of the DP does not affect display projection

DEF = 100

Projection for 60 mV > MA.A = 500 Example

100	100	100	200	300	400
500	FOA				



FOA **Setting projection of the decimal point**

- positioning of the DP is set here in the measuring mode

DEF = FLP.

Projection of DP on display > 000 Example

FLP.	000	MNU
------	-----	-----

*subsequent item on the menu depends on instrument equipment

6. SETTING PROFI

MEASURING MODE > OMX 102DC

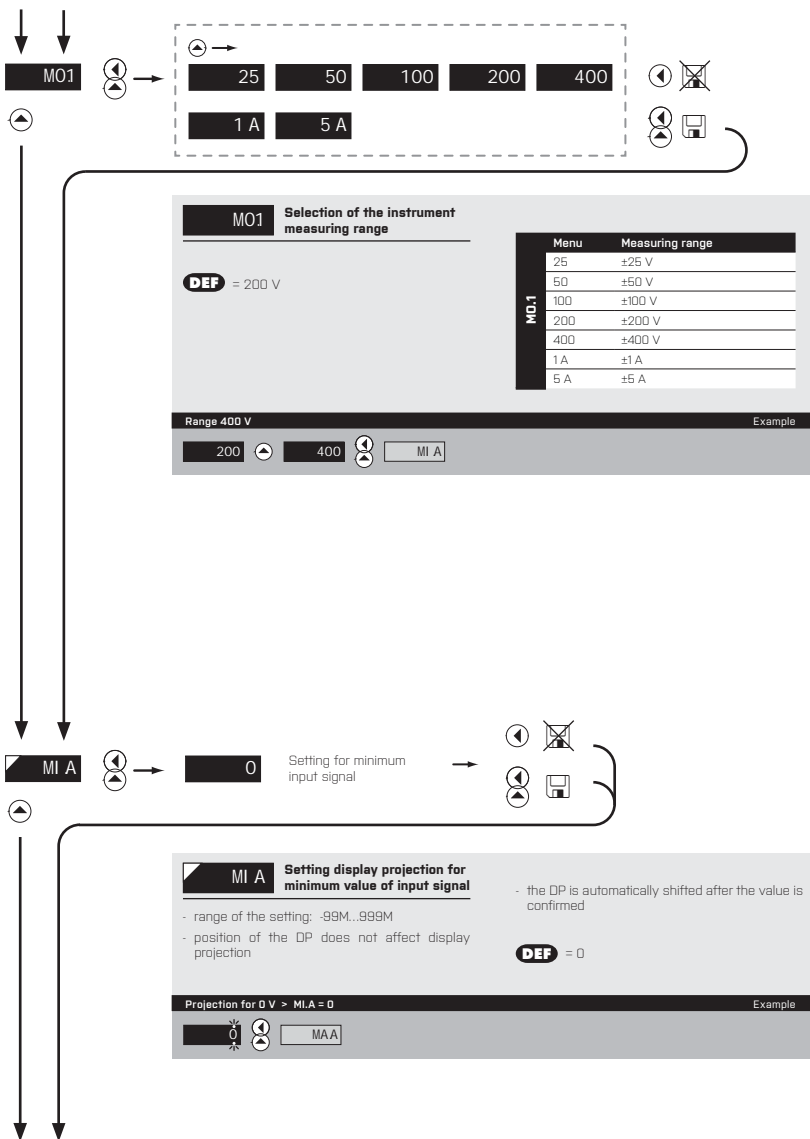



MAXA Setting display projection for maximum value of input signal

- range of the setting: -99M...999M
- position of the DP does not affect display projection

- the DP is automatically shifted after the value is confirmed

DEF = 100

Projection for 200 V > MA.A = 400 Example

100 100 100 200 300 400

FOA



FOA Setting projection of the decimal point

- positioning of the DP is set here in the measuring mode

DEF = FLP.

Projection of DP on display > 000 Example

FLP. 000 MNU

*subsequent item on the menu depends on instrument equipment

5. SETTING LIGHT

MEASURING MODE > PM

The diagram shows a navigation path starting from the **MO1** menu. From **MO1**, pressing the right arrow key leads to a sub-menu with options **u 2**, **u 5**, **u 10**, **I 4**, and **E 4**. Pressing the left arrow key from **MO1** leads to the **MI A** menu. From **MI A**, pressing the right arrow key leads to a screen showing **0** with the text "Setting for minimum input signal". Pressing the left arrow key from **MI A** leads to the "Setting display projection for minimum value of input signal" screen.

MO1 Selection of the instrument measuring range

DEF = I 4. [4 · 20 mA]

Menu	Measuring range
u 2	+2 V
u 5	+5 V
u 10	+10 V
I 5	+5 mA
I 0	+20 mA
I 4	4..20 mA
E 4	4..20 mA, with error statement of „underflow“ upon signal smaller than 3,36 mA

Range 4..20 mA Example

I 4

MI A Setting display projection for minimum value of input signal

- range of the setting: -99M..999M
- position of the DP does not affect display projection

- the DP is automatically shifted after the value is confirmed

DEF = 0

Projection for 4 mA > MI A = -25 Example

0	1	2	3	4	5
05	15	25	025	125	225
325	425	525	625	725	825
925	-25	<input type="text" value="MAA"/>			

MAA → **100** Setting for maximum input signal

FOA → **000** **00.0** **0.00** **FLP.**

MAA **Setting display projection for maximum value of input signal**

- range of the setting: -99M...999M
- position of the DP does not affect display projection

- the DP is automatically shifted after the value is confirmed

DEF = 100

Projection for 20 mA > M.A.A = 250 Example

100	100	110	120	130	140
150	150	250	FOA		

FOA **Setting projection of the decimal point**

- positioning of the DP is set here in the measuring mode

DEF = FLP.

Projection of DP on display > 000 Example

FLP.	000	MNU
------	-----	-----

*subsequent item on the menu depends on instrument equipment

38

5. SETTING LIGHT

MEASURING MODE > OHM

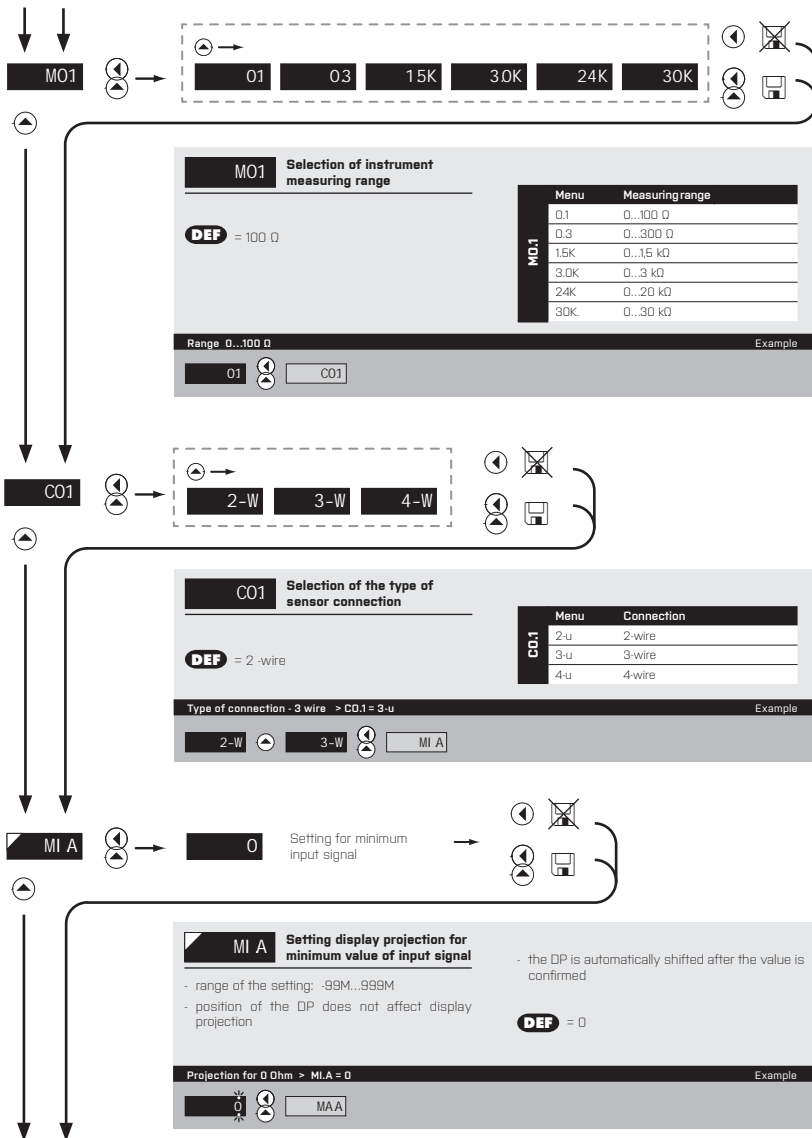

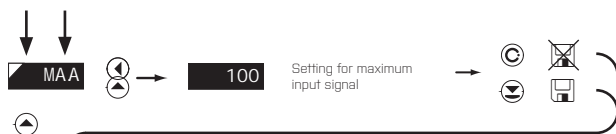

MAA Setting display projection for maximum value of input signal

- range of the setting: -99M...999M
- position of the DP does not affect display projection

- the DP is automatically shifted after the value is confirmed

DEF = 100

Projection for 300 Ohm > MA.A = 350 Example

100	100	110	120	130	140
150	150	250	350	FOA	



FOA Setting projection of the decimal point

- positioning of the DP is set here in the measuring mode

DEF = FLP.

Projection of DP on display > 000 Example

FLP.	000	MNU
------	-----	-----

*subsequent item on the menu depends on instrument equipment

5. SETTING LIGHT

MEASURING MODE > RTD-Pt

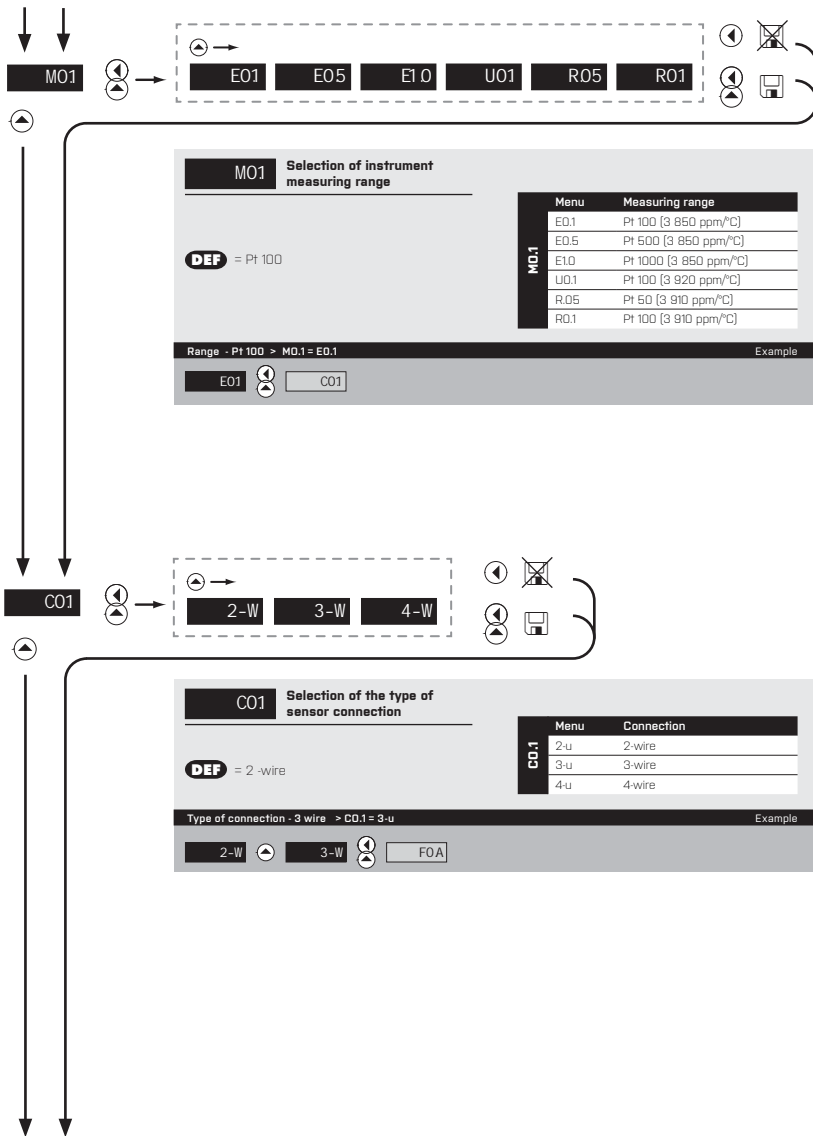

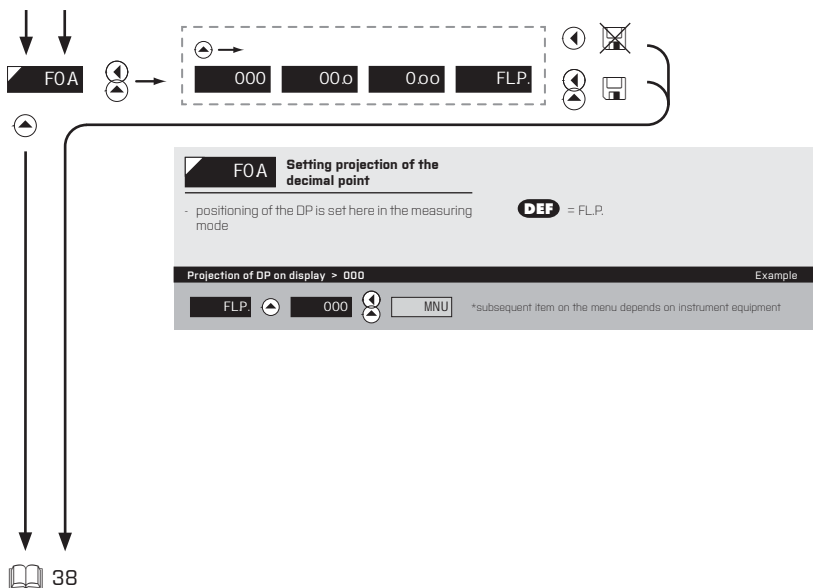

6. SETTING PROFI

MEASURING MODE > RTD-CU

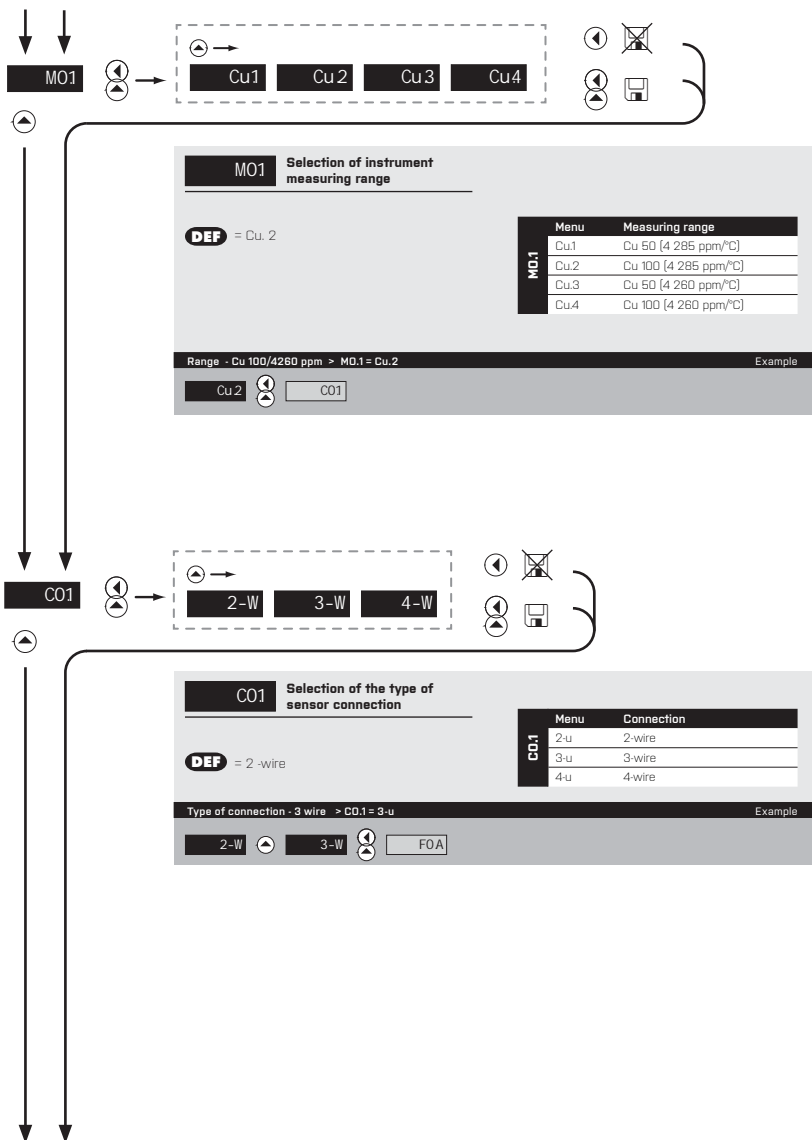

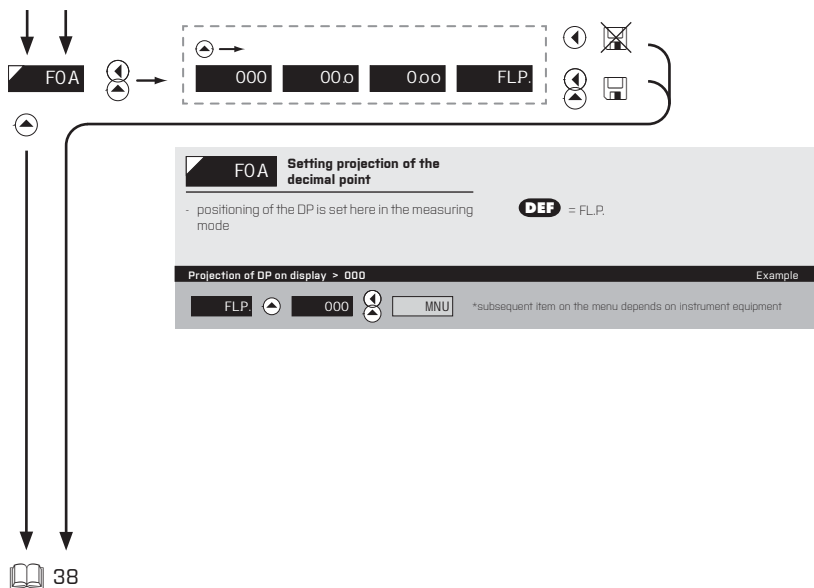

5. SETTING LIGHT

MEASURING MODE > RTD-Ni

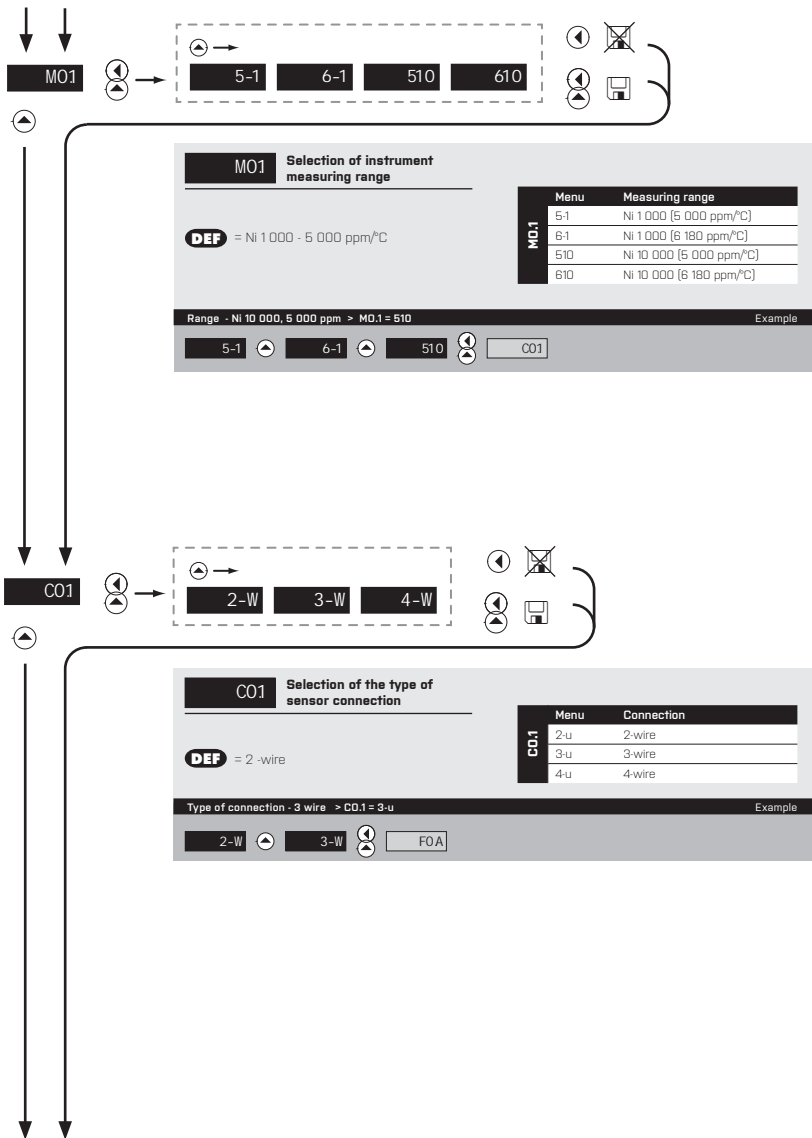

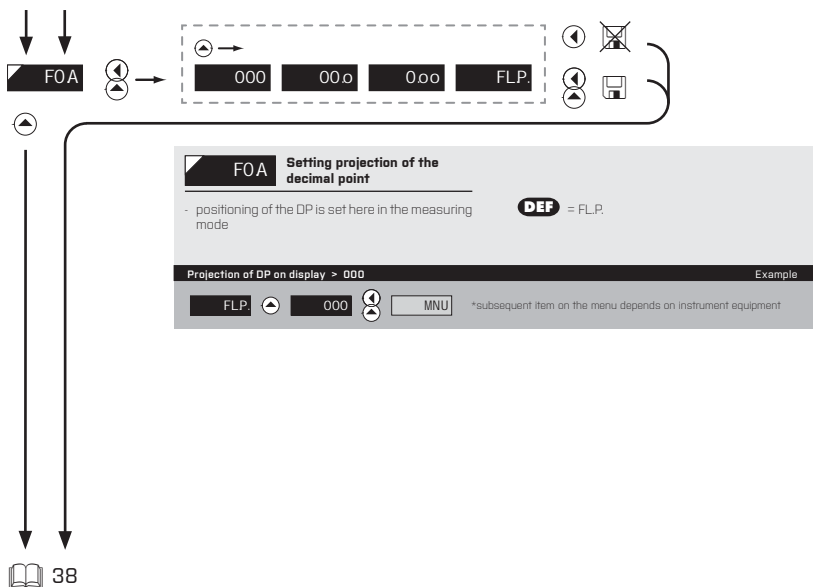

5. SETTING LIGHT

MEASURING MODE > T/C

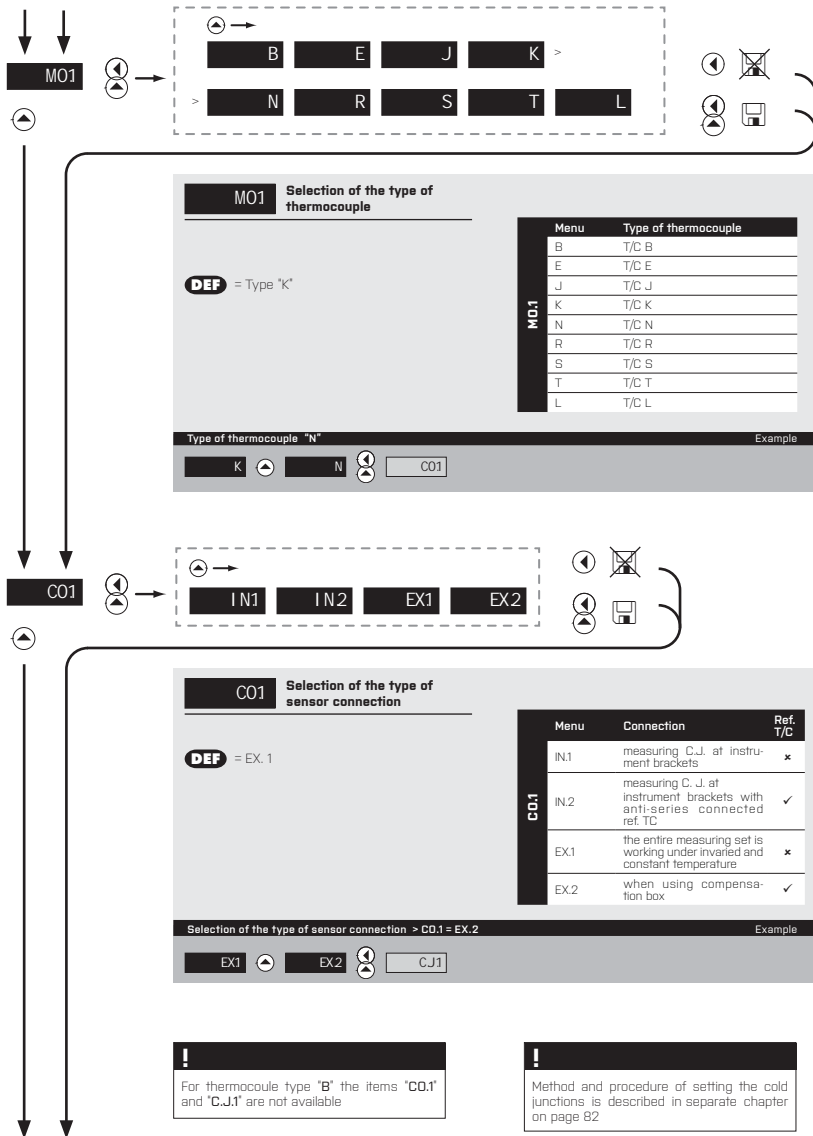

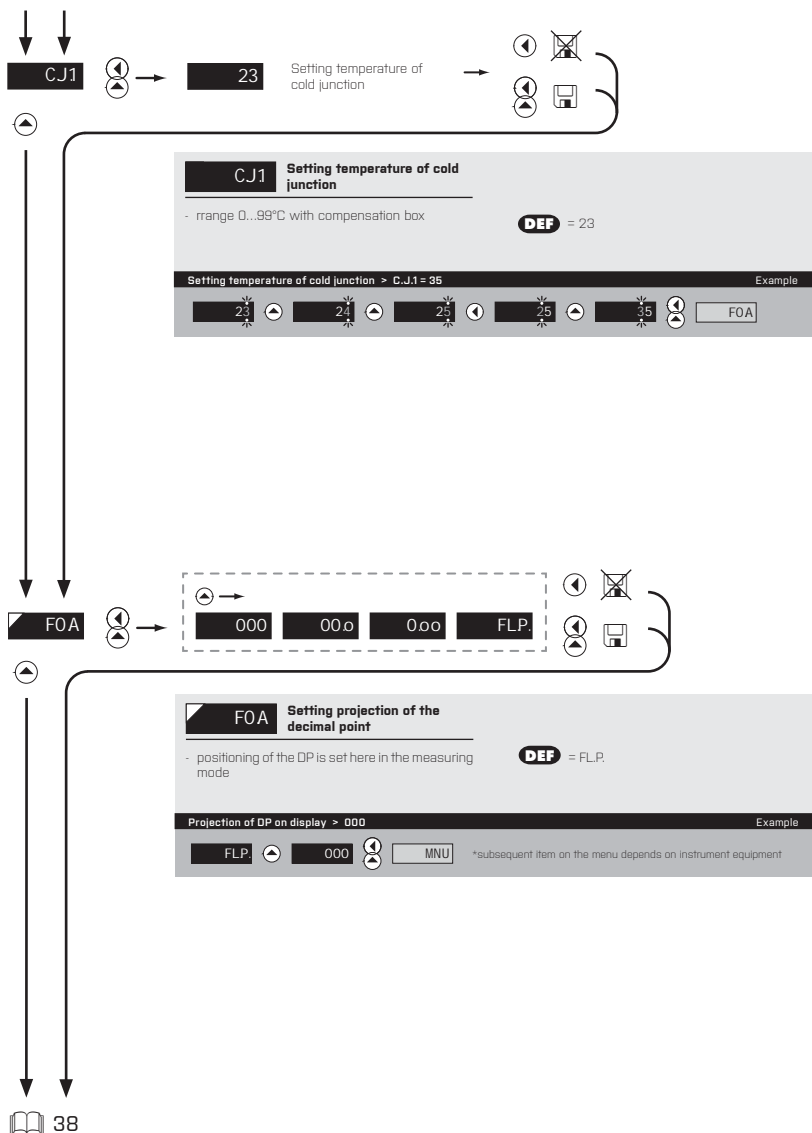

5. SETTING LIGHT

MEASURING MODE > DU

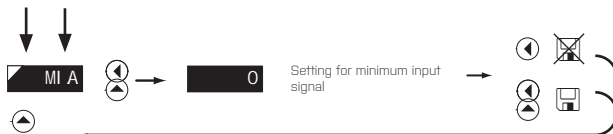

MI N **Setting display projection for minimum value of input signal**

- range of the setting: -99M...999M
- position of the DP does not affect display projection

- the DP is automatically shifted after the value is confirmed

DEF = 0

Projection for the beginning > MI.A = 0 Example



MAA **Setting display projection for maximum value of input signal**

- range of the setting: -99M...999M
- position of the DP does not affect display projection

- the DP is automatically shifted after the value is confirmed

DEF = 100

Projection for the end > MA.A = 250 Example

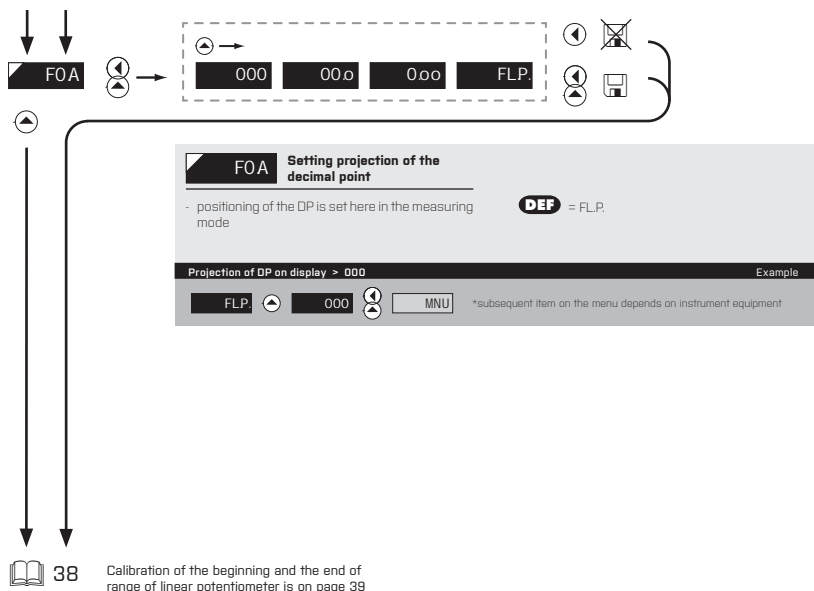

5. SETTING LIGHT

DISPLAYED ONLY WITH OPTIONS > COMPARATORS



L1 Setting boundary for limit 1

- range of the setting: -99M...999M
- contingent modification of hysteresis or delay may be performed in 'PROFI' menu

DEF = 25
DEF „Hysteresis“=0, „Delay“=0

Setting limit 1 > L.1 = 30 Example

25	26	27	28	29	20
20	30	MNU	*subsequent item on the menu depends on instrument equipment		

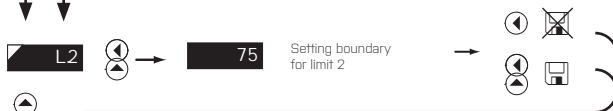

L2 Setting boundary for limit 2

- range of the setting: -99M...999M
- contingent modification of hysteresis or delay may be performed in 'PROFI' menu

DEF = 75
DEF „Hysteresis“=0, „Delay“=0

Setting limit 2 > L.2 = 205 Example

75	75	85	95	05	105
205	MNU	*subsequent item on the menu depends on instrument equipment			

!
Items for "Limits" and "Analog output" are accessible only if incorporated in the instrument.



TA1 Setting the type of analog output

Menu	Range	Description
I.20	0...20 mA	
E.T.4	4...20 mA	with error message indication and broken loop indication (<3.6 mA)
T.4	4...20 mA	with broken loop indication (<3.6 mA)
E.4	4...20 mA	with indication of error statement (<3.6 mA) DEF
I.4	4...20 mA	
I.5	0...5 mA	
u.2	0...2 V	
u.5	0...5 V	
u.10	0...10 V	
.10	±10 V	
FRE.	0.2...2200 Hz	

Type of analog output - 0...10 V > T.A.1 = U 10 Example

I 4 I 5 u 2 u 5 u 10 AL1

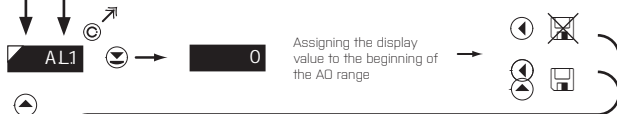

AL1 Assigning the display value to the beginning of the AD range

range **DEF** = 0

- range of the setting: -99M...999M

Display value for the beginning of the AD range > A.L.1 = 0 Example

0 AH1



AH1 Assigning the display value to the end of the AD range

DEF = 100

- range of the setting: -99M...999M

Display value for the end of the AD range > A.H.1 = 120 Example

100 100 110 120 MNU

5. SETTING LIGHT

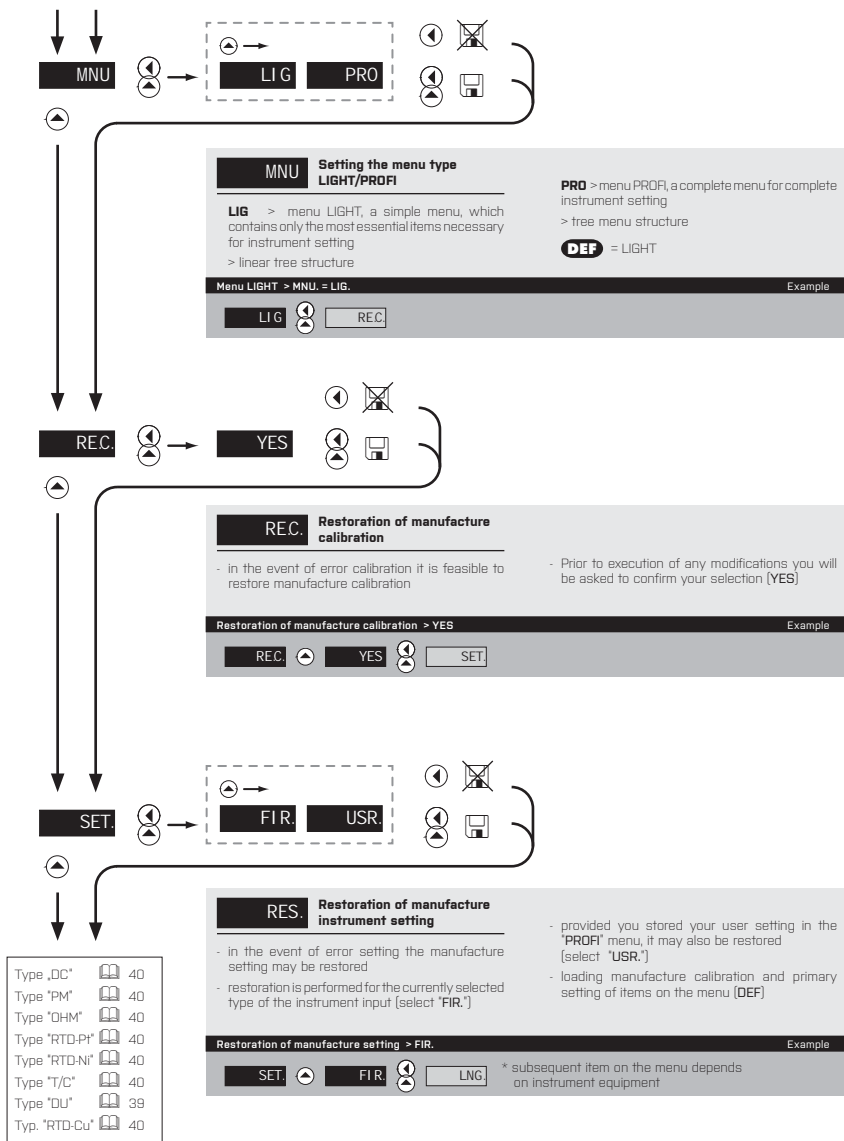



CL1 Calibration of input range - the potentiometer traveller in initial position Only for type "DU"

- prior confirming the flashing "YES" sign the potentiometer traveller has to be in given idle position

Calibration of the beginning of the range > C.L.1 Example

YES 



CH1 Calibration of input range - the potentiometer traveller in end position Only for type "DU"

- prior confirming the flashing "YES" sign the potentiometer traveller has to be in given idle position

Calibration of the end of the range > C.L.1 Example

YES 

5. SETTING LIGHT

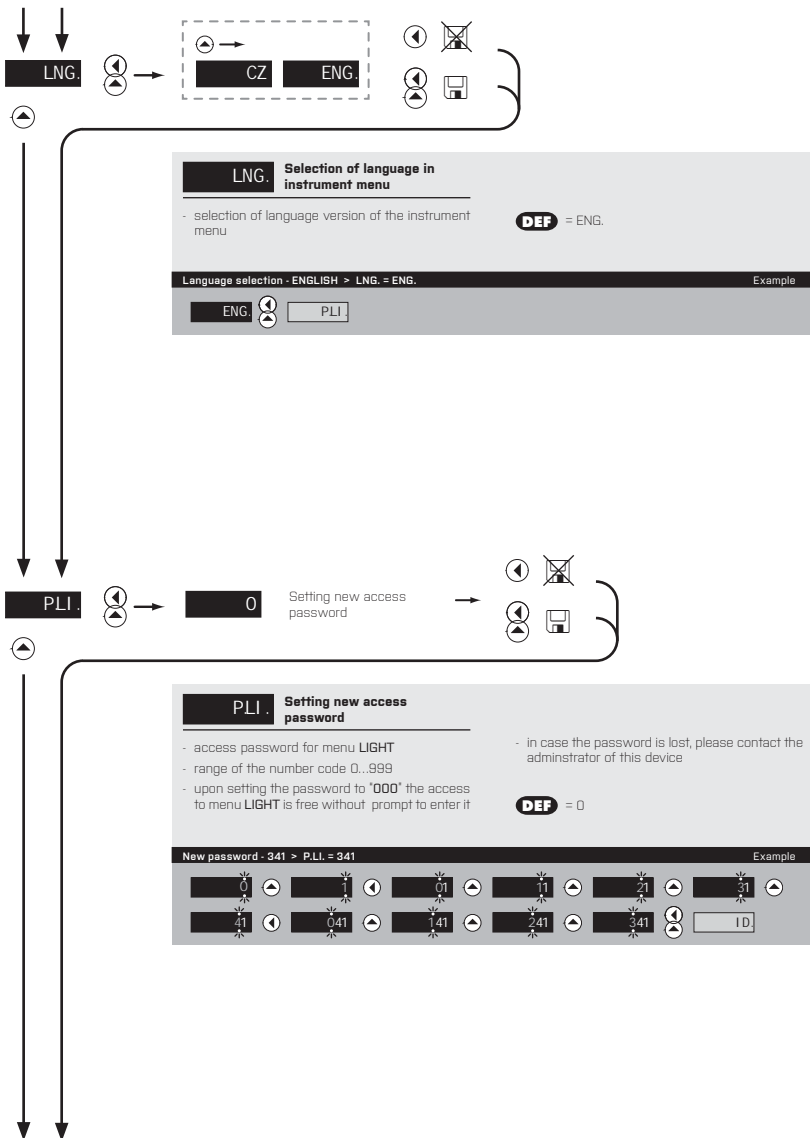



ID. Instrument SW version

- the display shows the type of instrument indication, SW number, SW version and current input setting [Mode]
- if SW version contains a letter in first position, then it is a customer SW
- after the identification is completed the menu is automatically exited and the instrument restores the measuring mode

142

Return to measuring mode



SETTING **PROFI**

For expert users

Complete instrument menu

Access is password protected

Possibility to arrange items of the **USER MENU**

Tree menu structure

6.0

SETTING "PROFI"

PROFI

Complete programming menu

- contains complete instrument menu and is protected by optional number code
- designed for expert users
- preset from manufacture is menu **LIGHT**

Switching over to "PROFI" menu



> 2s

- access to **PROFI** menu
- authorization for access to **PROFI** menu does not depend on setting under item SER. > MNU.
- password protected access [unless set as follows under the item SER. > N.PA. > PROF1 =0]



< 2s

- access to menu selected under item SER. > MNU. > **LIGHT/PROFI**
- password protected access [unless set as follows under the item SER. > N.PA. > LIGHT =0]
- for access to **LIGHT** menu passwords for **LIGHT** and **PROFI** menu may be used



6. SETTING PROFI

6.1 SETTING "PROFI" - INPUT

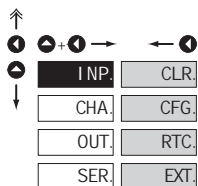

The primary instrument parameters are set in this menu

CLR	Resetting internal values
CFG	Selection of measuring range and parameters
RTC	Setting date and time for option with RTC
EXT	Setting external inputs functions

6.1.1 RESETTING INTERNAL VALUES

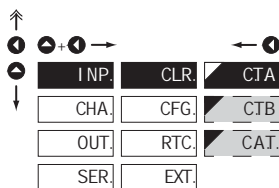

CLR	Resetting internal values
CTA	Tare resetting - Channel A
CTB	Tare resetting - Channel A
CAT	Tare resetting on both channels simultaneously



Only for DC, PM and DU types

6.1.2a SELECTION OF MEASURING RATE

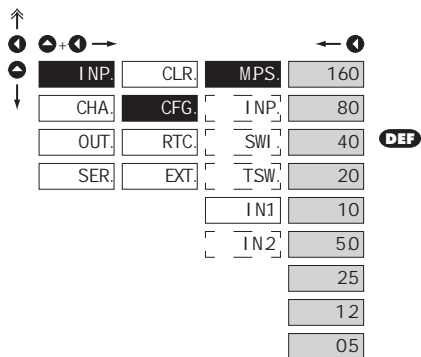

MPS. Selection of measuring rate

160	160 measurements/s
80	80 measurements/s
40	40 measurements/s
20	20 measurements/s
10	10 measurements/s
50	5 measurements/s
25	2,5 measurements/s
12	1,2 measurements/s
05	0,5 measurements/s

6.1.2a SELECTION OF THE NUMBER OF ACTIVE INPUTS

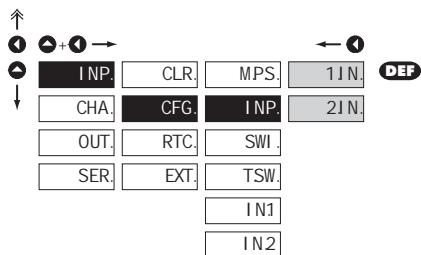

I NP. Selection of the number of active inputs

- this menu item is accessible only in the 2-input version of the device

1 I N.	Active input 1
2 I N.	Active inputs 1 and 2

6. SETTING PROFI

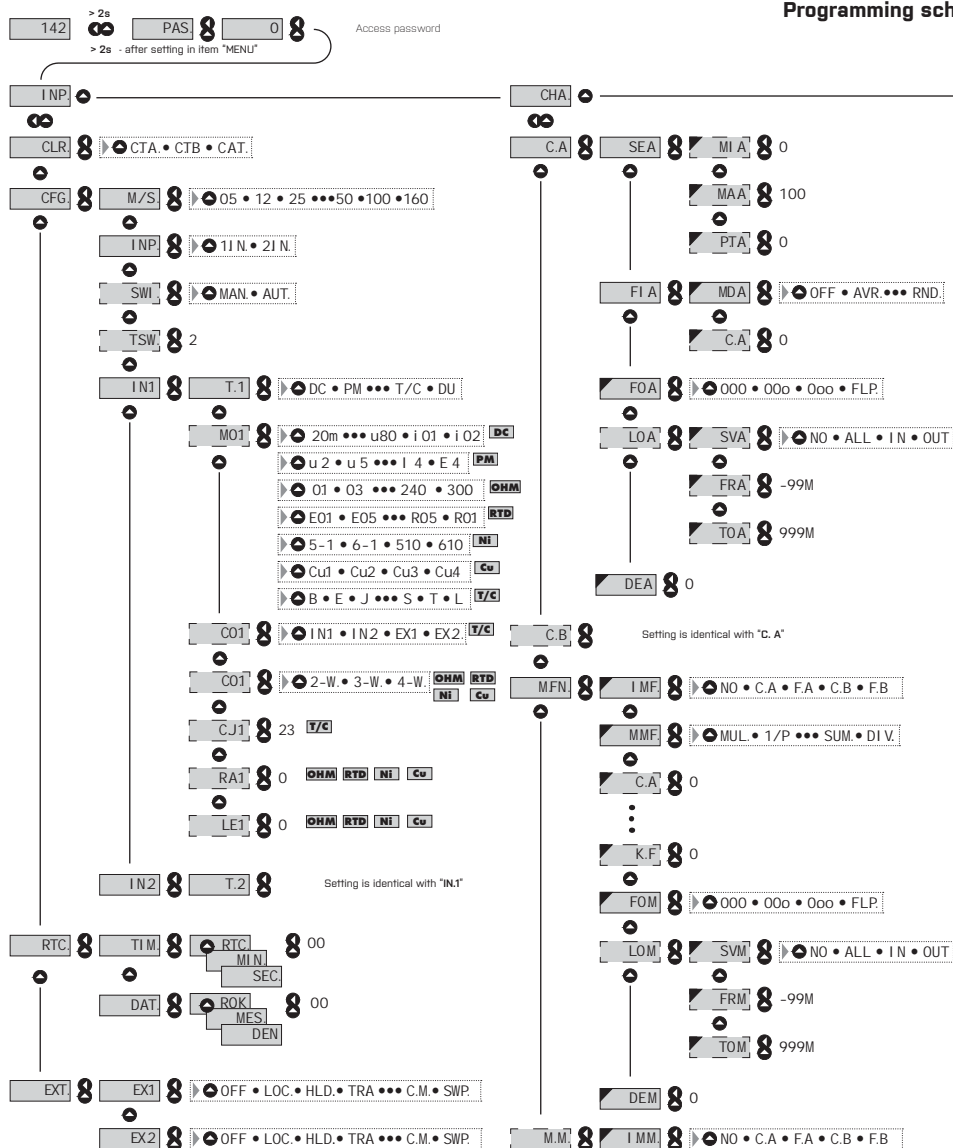

HOME PROFI MENU

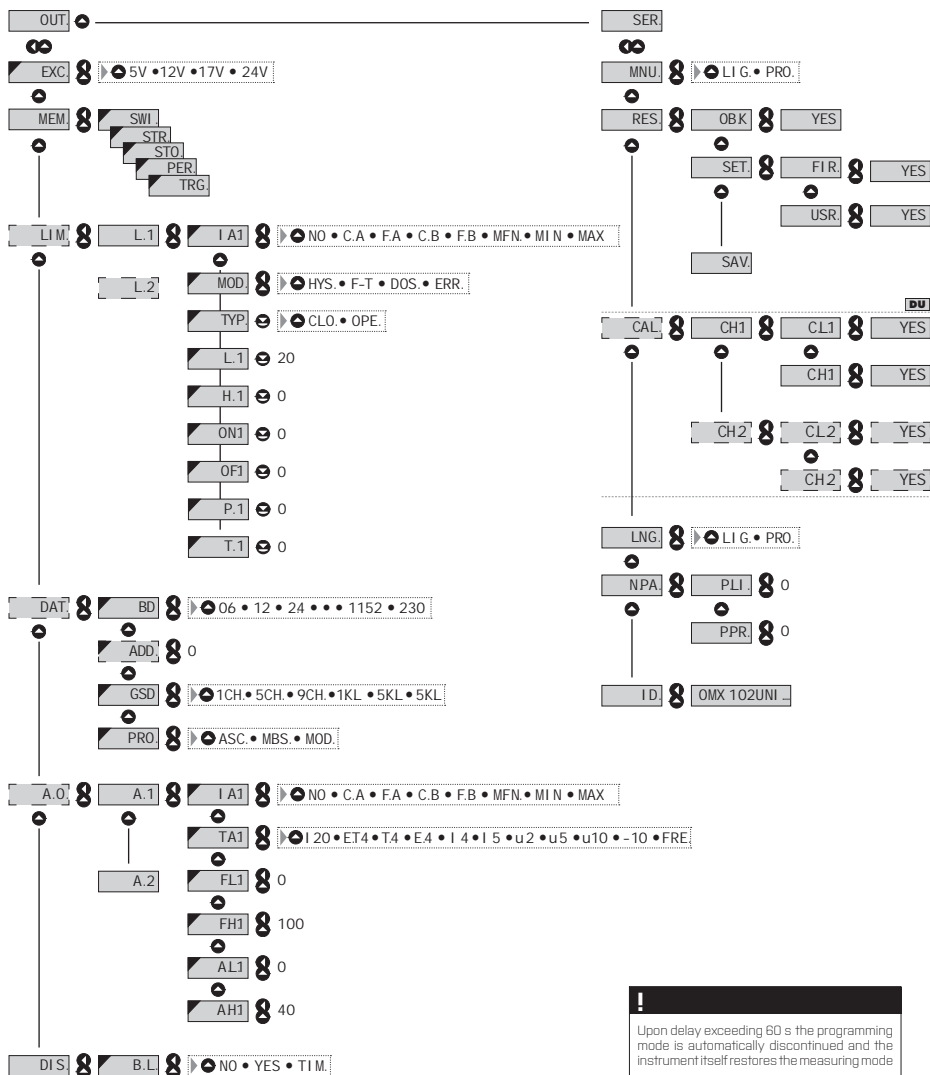

!
Upon delay exceeding 60 s the programming mode is automatically discontinued and the instrument itself restores the measuring mode

6.1.2c SELECTION OF INPUTS SWITCHING

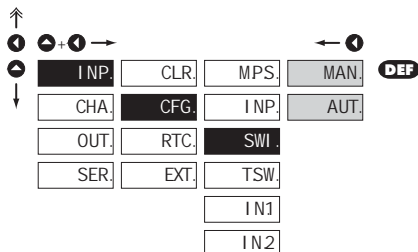

SWI. Selection of inputs switching

- this menu item is accessible only in the 2-input version of the device

MAN. Manual inputs switching

- inputs switching is controlled by selected key on the front panel or selected external input

AUT. Automatic inputs switching

- inputs switching is automatic in a time period set in "T.SW."

6.1.2d SETTING THE PERIOD FOR INPUTS SWITCHING

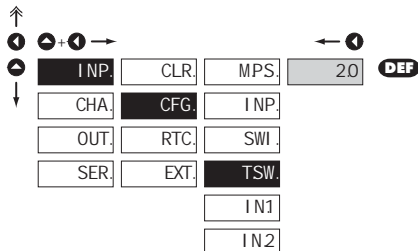

SWI. Setting the period for inputs switching

- setting the time period for projection of channels in automatic mode of inputs switching ["AUT."]

- range of the setting: 0,5...99,5 s (step 0,5)

DEF T.SW. = 2 s

6.1.2e

SELECTION OF „INSTRUMENT“ TYPE FOR CHANNEL 1

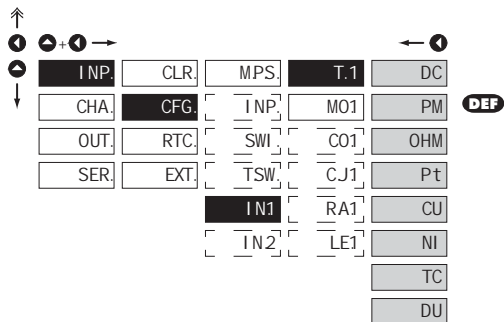
**T.1** Selection of „instrument“ type

- selection of particular type of "instrument" is bound to relevant dynamic items

DC	DC voltmeter
PM	Process monitor
OHM	Ohmmeter
Pt	Thermometer for Pt xxx
Cu	Thermometer for Cu xxx
Ni	Thermometer for Ni xxxx
TC	Thermometer pro thermocouples
DU	Display for linear potentiometers

6.1.2f

SELECTION OF MEASURING RANGE FOR CHANNEL 1

↑ 1 ← →

←

INP	CLR	MPS	T.1	30m	1.A	102DC
CHA	CFG	INP	MO1	60m	5.A	
OUT	RTC	SWI	CO1	u1	25	DEF
SER	EXT	TSW	CJ1	u20	50	
		IN1	RA1	u40	100	
		IN2	LE1	u80	200	
				i 01	400	
				i 02		
			OHM	01		DEF
				03		
				15		
				3.0		
				24		
				30		
		DEF	Pt	E01	PM	DEF
				E05	u 2	
				E10	u 5	
				U01	I 0	
				r05	I 4	
				r01	E 4	
		DEF	Ni	5-1	T/C	DEF
				6-1	B	
				510	E	
				610	J	
					K	
		DEF	Cu		N	DEF
				Cu1	R	
				Cu2	S	
				Cu3	T	
				Cu4	L	

MOD.		Selection of instrument measuring range	
Menu	Measuring range		
DMX 102DC			
1.A	±1A		
5.A	±5.A		
25	±25V		
50	±50 V		
100	±100 V		
200	±200 V		
400	±400 V		
DC			
30m	±30 mV		
60m	±60 mV		
u 1	±81 V		
u20	±20 V		
u40	±40 V		
u80	±80 V		
i 01	±90 mA		
i 02	±180 mA		
PM			
u 2	±2 V		
u 5	±5 V		
u10	±10 V		
I 5	±5 mA		
I 0	±20 mA		
I 4	4..20 mA		
E 4	4..20 mA, with error statement of „underflow“ upon signal smaller than 3,36 mA		
OHM			
0.1	0...100 Ω		
0.3	0...300 Ω		
1.5	0...1.5 kΩ		
3.0	0...3 kΩ		
24	0...24 kΩ		
30	0...30 kΩ		
RTD			
Menu		Measuring range	
E0.1	Pt 100 (3 850 ppm/°C)		
E0.5	Pt 500 (3 850 ppm/°C)		
E1.0	Pt 1000 (3 850 ppm/°C)		
U0.1	Pt 100 (3 920 ppm/°C)		
R.05	Pt 50 (3 910 ppm/°C)		
R0.1	Pt 100 (3 910 ppm/°C)		
NI			
Menu		Measuring range	
5-1	Ni 1 000 (5 000 ppm/°C)		
6-1	Ni 1 000 (5 180 ppm/°C)		
510	Ni 10 000 (5 000 ppm/°C)		
610	Ni 10 000 (5 180 ppm/°C)		
CU			
Menu		Measuring range	
Cu.1	Cu 50 (4 260 ppm/°C)		
Cu.2	Cu 100 (4 260 ppm/°C)		
Cu.3	Cu 50 (4 260 ppm/°C)		
Cu.4	Cu 100 (4 260 ppm/°C)		
T/C			
Menu		Type of thermocouple	
B	T/C B		
E	T/C E		
J	T/C J		
K	T/C K		
N	T/C N		
R	T/C R		
S	T/C S		
T	T/C T		
L	T/C L		

6.1.2g

SELECTION OF THE TYPE OF SENSOR CONNECTION FOR CHANNEL 1

RTD OHM T/C

↑

← + →

↓

INP.	CLR.	MPS.	T.1	2-w	DEF
CHA.	CFG.	INP.	MO1	3-w	
OUT.	RTC.	SW.	CO1	4-w	
SER.	EXT.	TSW.	RA1		
		IN1	LE1		
		IN2			

↑

← + →

↓

INP.	CLR.	MPS.	T.1	In1	DEF
CHA.	CFG.	INP.	MO1	In2	
OUT.	RTC.	SW.	CO1	Ex1	
SER.	EXT.	TSW.	CJ1	Ex2	
		IN1			
		IN2			

C01 Selection of the type of sensor connection

RTD OHM

2-w 2-wire connection

3-w 3-wire connection

4-w 4-wire connection

T/C

IN1 Measurement without reference thermocouple

- measuring cold junction at instrument brackets

IN2 Measurement with reference thermocouple

- measuring cold junction at instrument brackets with anti-series connected reference thermocouple

EX1 Measurement without reference thermocouple

- the entire measuring set is working under invaried and constant temperature

EX2 Measurement with reference thermocouple

- when using compensation box

!

Method and procedure of setting the cold junctions is described in separate chapter on page 82

!

For thermocouple type „B“ the items „CO1“ and „C.J1“ are not available

6. SETTING PROFI

6.1.2h SETTING TEMPERATURE OF COLD JUNCTION FOR CHANNEL 1

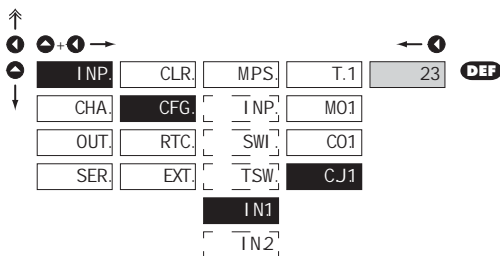
T/C

CJ1 Setting temperature of cold junction

- range 0...99°C with compensation box
- setting of cold junction compensation is identical both for „Channel 1“ and „Channel 2“
- **DEF** = 23°C

6.1.2i ZERO OFFSET OF THE MEASUREMENT RANGE FOR CHANNEL 1

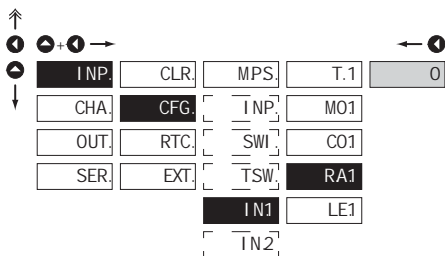
RTD OHM

RA1 Offset of the beginning of the measuring range

- in cases when it is necessary to offset the beginning of the range by certain value, e.g. while using sensor in measuring head
- entered directly in Ohm (0...999)
- **DEF** = 0

6.1.2j COMPENSATION OF 2-WIRE CONDUCT FOR CHANNEL 1

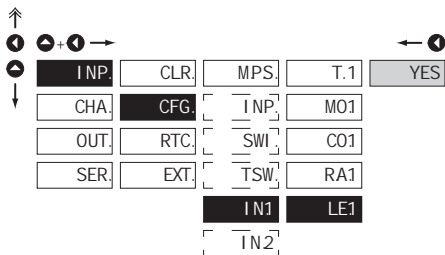
RTD OHM

LE1 Compensation of 2-wire conduct

- for measurement accuracy it is necessary to perform compensation of conduct always in case of 2-wire connection
- prior confirmation of the displayed prompt 'YES' it is necessary to substitute the sensor at the end of the conduct by a short-circuit
- **DEF** = 0

6.1.2k

SELECTION OF „INSTRUMENT“ TYPE FOR CHANNEL 2

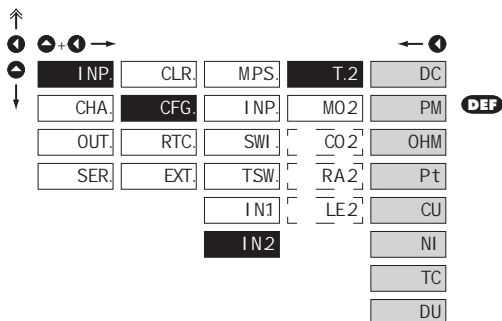

T.2 Selection of „instrument“ type

- selection of particular type of "instrument" is bound to relevant dynamic items

DC	DC voltmeter
PM	Process monitor
OHM	Ohmmeter
Pt	Thermometer for Pt xxx
Cu	Thermometer for Cu xxx
Ni	Thermometer for Ni xxx
TC	Thermometer pro thermocouples

- first thermocouple has to be connected to „Channel 1“, because that is where the temperature for cold junction compensation is taken

- in menu „Channel 2“ the temperature of cold junction compensation is not set (it is adopted from „Channel 1“)

DU	Display for linear potentiometers
----	-----------------------------------

*

Following settings are identical with menu items for „IN1“

6.1.3

SETTING THE REAL TIME CLOCK

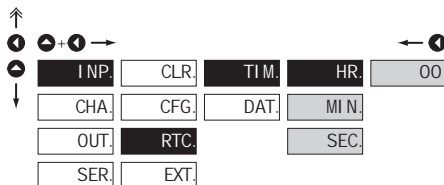

RTC. Setting the real time clock (RTC)

TIM.	Time setting
------	--------------

- format 23.59.59

DAT.	Date setting
------	--------------

- format DD.MM.RR

6. SETTING PROFI

6.1.4

EXTERNAL INPUT FUNCTION SELECTION

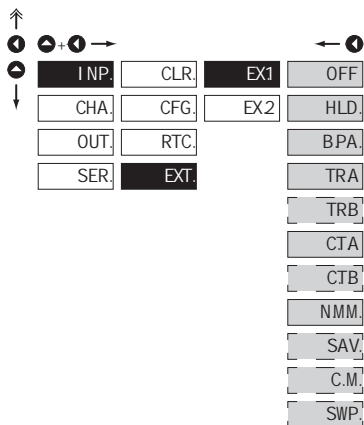

EXT.	External input function selection
OFF	Input is off
HLD.	Activation of HOLD
B.P.A.	Activation of locking access into programming menu
LIGHT/PROFI	
TRA	Tare activation for Channel 1
TRB	Tare activation for Channel 2
CTA	Tare resetting for Channel 1
CTB	Tare resetting for Channel 2
NMM.	Resetting min/max value
SAV.	Activation of measured data record in instrument memory for option FAST/RTC
C.M.	Clearing memory for option FAST/RTC
SWP.	Swapping between analogue inputs/outputs
	- Swapping between analogue outputs (configuration: 1x input > 2x output)
	- Swapping between analogue inputs (configuration: 2x input > 1x output)
	- DEF EX.1 > HLD.
	- DEF EX.2 > B.P.A.
*	
Identical procedure to the one shown above can also be applied to „EX.2“	



6. SETTING PROFI

6.2 SETTING "PROFI" - CHANNELS

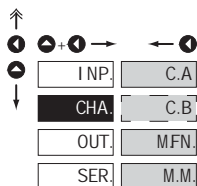

In this section of the menu input parameters are set

C.A.	Setting of parameters of measuring input "Channel 1"
C.B.	Setting of parameters of measuring input "Channel 2"
M.F.N.	Setting of parameters of mathematical functions
M.M.	Selecting the input for evaluating the Min/Max value

6.2.1a DISPLAY PROJECTION FOR CHANNEL 1

DC AC PM DU OHM

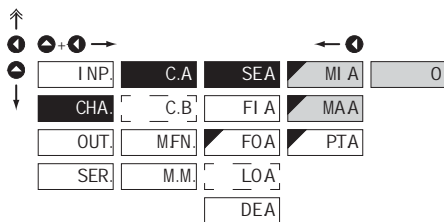

SEA Setting display projection

MI A Setting display projection for minimum value of input signal
 - range of the setting: -99M...999M
 - **DEF** = 0

MAA Setting display projection for maximum value of input signal
 - range of the setting: -99M...999M
 - **DEF** = 100



Setting is identical with channel „C. B“

6.2.1b SETTING FIXED TARE FOR CHANNEL 1

DC AC PM DU OHM

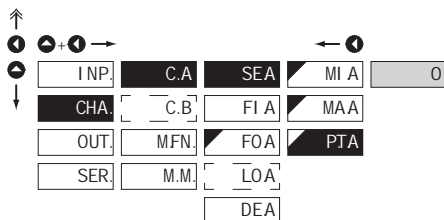

SEA Setting "Fixed tare" value

- setting is designed for the event when it is necessary to firmly shift the beginning of the range by known size
 - when setting [P.T.A≠0] is in effect, display does not show the 'T' symbol
 - range of the setting: -99M...999M
 - **DEF** = 0

6.2.1c DIGITAL FILTERS FOR CHANNEL 1

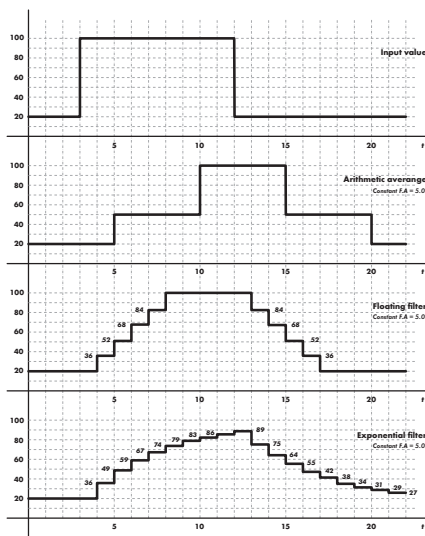
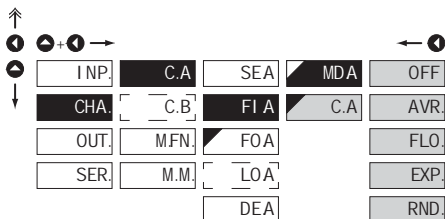
**FI A** Selection of digital filters

- at times it is useful for better user projection of data on display to modify it mathematically and properly, wherefore the following filters may be used

OFF Filters are off**AVR.** Measured data average

- arithmetic average from given number „C. A“ of measured values
- range 2...100

FLO. Selection of floating filter

- floating arithmetic average from given number „C. A“ of measured data and updates with each measured value
- range 2...30

EXP. Selection of exponential filter

- integration filter of first prvnho grade with time constant „C. A“ measurement
- range 2...100

RND. Measured value rounding

- is entered by any number, which determines the projection step (e.g.: „C. A“=2,5 > display 0, 2,5, 5,...)

C.A Setting constants

- this menu item is always displayed after selection of particular type of filter

DEF = 2

Setting is identical with channel „C. B“

6. SETTING PROFI

6.2.1d PROJECTION FORMAT - POSITIONING OF DECIMAL POINT FOR CHANNEL 1

↑	←	+	1	→					
↓	←			→					←
		INP	C.A	SEA				000	
		CHA	C.B	FI A				00o	
		OUT	MFN	FOA				0o0	
		SER	M.M	LOA				FLP	
				DEA					



Setting is identical with channel „C. B“

FOA Selection of decimal point

- the instrument allows for classic projection of a number with positioning of the DP as well as projection with floating DP, allowing to display a number in its most exact form „FLP.“

000 Setting DP - XXX

00o Setting DP - XX.x

0o0 Setting DP - X.xx

FLP. Floating DP

6.2.1e SELECTION OF STORING DATA INTO INSTRUMENT MEMORY FOR CHANNEL 1

↑	←	+	1	→					
↓	←			→					←
		INP	C.A	SEA	SVA			NO	
		CHA	C.B	FI A	FRA			ALL	
		OUT	MFN	FOA	TOA			IN	
		SER	M.M	LOA				OUT	
				DEA					



Setting is identical with channel „C. B“

LOA Selection of storing data into instrument memory

- by selection in this item you allow to register values into instrument memory
- another setting in item "OUT. > MEM." (not in standard experiment)

NO Measured data is not stored

ALL Measured data is stored in memory

IN Only data measured within the set interval is stored in memory

OUT Only data measured outside the set interval is stored in memory

FRA Setting the initial interval value

- range of the setting: -99M...999M

DEF = -99M

TOA Setting the final interval value

- range of the setting: -99M...999M

DEF = 999M

6.2.1f PROJECTION OF DESCRIPTION - THE MEASURING UNITS FOR CHANNEL 1

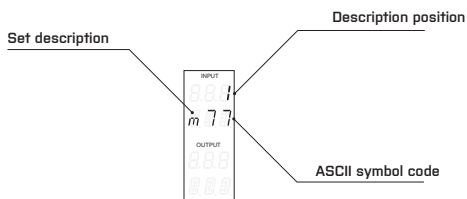
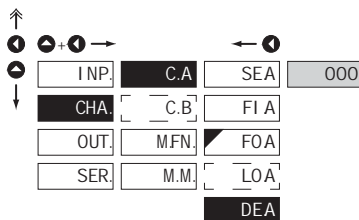
**DEA** Setting projection of description

- 3 characters can be added to standard numerical formats
- setting is realised using modified ASCII code, where upper number defines position of the character, bottom line at the first position displays the character and at the last two positions show the code of the character in interval 0...96.
- description is cancelled by code 000
- **RTD** **T/C** **DEF** = °C
- **DC** **PM** **DU** **OHM** **DEF** = none

! Table of signs on page 86

! Setting is identical with channel „C. B“

6. SETTING PROFI

6.2.2a MATHEMATIC FUNCTIONS - INPUT SELECTION

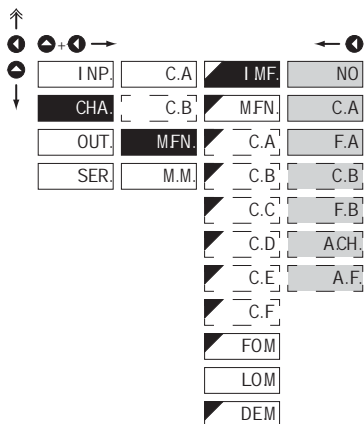

I.MF. Selection of input for calculation of mathematic function

- selection of value from which the mathematic function will be calculated

NO	Mathematic functions are off
C.A.	From "Channel A"
F.A.	From "Channel A" after modification by digital filter
C.B.	From "Channel B"
F.B.	From "Channel B" after modification by digital filter
A.CH.	From "Channels A, B"
A.F.	From "Channels A, B," after modification by digital filters

6.2.2b

MATHEMATIC FUNCTIONS

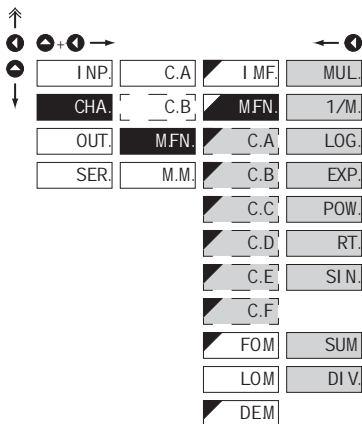
M.F.N. Selection of mathematic functions

On selecting „From chan. A/B“ in item „V.MF.“

 Multinomial

$$Ax^5 + Bx^4 + Cx^3 + Dx^2 + Ex + F$$

 $1/x$

$$\frac{A}{x^3} + \frac{B}{x^4} + \frac{C}{x^3} + \frac{D}{x^2} + \frac{E}{x} + F$$

 Logarithm

$$A \times \ln\left(\frac{Bx + C}{Dx + E}\right) + F$$

 Exponential

$$A \times e^{\left(\frac{Bx + C}{Dx + E}\right)} + F$$

 Power

$$A \times (Bx + C)^{(Dx + E)} + F$$

 Root

$$A \times \sqrt{\frac{Bx + C}{Dx + E}} + F$$

On selecting „From chan. A*B“ in item „V.MF.“

 Sum of the values from channels (inputs)

$$(A \times KA + B \times KB + C \times KC + D \times KD) \times E + F$$

 Quotient of values from channels (inputs)

$$(A \times KA + C \times KC) / (B \times KB + D \times KD) \times E + F$$

 Setting constants for calculation of mat.functions

- this menu is displayed only after selection of given mathematic function

6. SETTING PROFI

6.2.2c PROJECTION FORMAT - POSITIONING OF DECIMAL POINT

INP.	C.A.	IMF.	000.
CHA.	C.B.	MFN.	00.0
OUT.	MFN.	C.A.	0.00
SER.	M.M.	C.B.	FLP.
		C.C.	
		C.D.	
		C.E.	
		C.F.	
		FOM.	
		LOM.	
		DEM.	

FOM Selection of decimal point

- the instrument allows for classic projection of a number with positioning of the DP as well as projection with floating DP, allowing to display a number in its most exact form „FLP.“

000	Setting DP - XXX
00.0	Setting DP - XX.x
0.00	Setting DP - X.xx
FLP.	Floating DP

6.2.2d MATHEMATIC FUNCTIONS - SELECTION OF STORING DATA INTO INSTRUMENT MEMORY

INP.	C.A.	IMF.	SVM.	NO
CHA.	C.B.	MFN.	FRM.	ALL
OUT.	MFN.	C.A.	TOM.	IN
SER.	M.M.	C.B.		OUT
		C.C.		
		C.D.		
		C.E.		
		C.F.		
		FOM.		
		LOM.		
		DEM.		

LOM Selection of storing data into instrument memory

- by selection in this item you allow to register values into instrument memory
- another setting in item "OUT. > MEM." (not in standard experiment)

NO	Measured data is not stored in memory
ALL	Measured data is stored in memory
IN	Only data measured within the set interval is stored in memory
OUT	Only data measured outside the set interval is stored in memory
FRM	Setting the initial interval value
	- range of the setting: -99M...999M
DEF	-99M
TOM	Setting the final interval value
	- range of the setting: -99M...999M
DEF	999M

6.2.2e MATHEMATIC FUNCTIONS - MEASURING UNITS

↑	←	→	←	↓
INP.	C.A	IMF.	000	
CHA.	C.B	MFN.		
OUT.	MFN.	C.A		
SER.	M.M.	C.B		
		C.C		
		C.D		
		C.E		
		C.F		
		FOM		
		LOM		
		DEM		

DEM Setting projection of description

- 3 characters can be added to standard numerical formats
- setting is realised using modified ASCII code, where upper number defines position of the character, bottom line at the first position displays the character and at the last two positions show the code of the character in interval 0...95.
- description is cancelled by code 000
- **RTD** **T/C** **DEF** = °C
- **DC** **PM** **DU** **OHM** **DEF** = none

! Table of signs on page 86

6.2.3 SELECTION OF EVALUATION OF MIN/MAX VALUE

↑	←	→	←	↓
INP.	C.A	IMM.	NO	
CHA.	C.B		C.A	DEF
OUT.	MFN.		F.A	
SER.	M.M.		C.B	
			F.B	
			MFN.	

IMM. Selection of evaluation of min/max value

- selection of value from which the min/max value will be calculated

NO	Evaluation of min/max value is off
C.A	From "Channel A"
F.A	From "Channel A" after digital filters processing
C.B	From "Channel B"
F.B	From "Channel B" after digital filters processing
MFN.	From "Mathematic functions"

6. SETTING PROFI

6.3 SETTING „PROFI“ - OUTPUTS

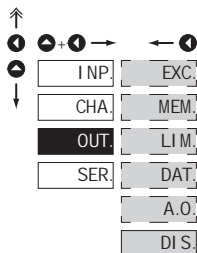

In this menu it is possible to set parameters of the instrument output signals

EXC.	Setting of excitation voltage
MEM.	Setting data logging into memory
LIM.	Setting type and parameters of limits
DAT.	Setting type and parameters of data output
A.O.	Setting type and parameters of analog output
DI S.	Setting of backlight

6.3.1 SETTING OF EXCITATION VOLTAGE

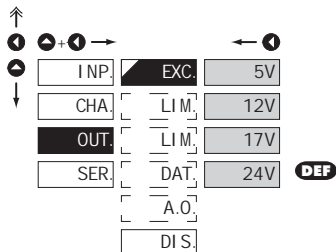

EXC.	Setting of excitation voltage
5V	5 VDC, max. 2,5 W
12V	12 VDC, max. 2,5 W
17V	17 VDC, max. 2,5 W
24V	24 VDC, max. 2,5 W

6.3.2a SELECTION OF MODE OF DATA LOGGING INTO INSTRUMENT MEMORY

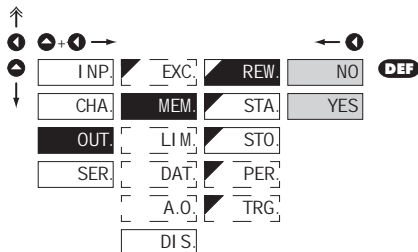

REW.	Selection of the mode of data logging
- selection of the mode in the event of full instrument memory	
NO	Rewriting values prohibited
YES	Rewriting values permitted, the oldest get rewritten by the latest

6.3.2b SETTING DATA LOGGING INTO INSTRUMENT MEMORY - RTC

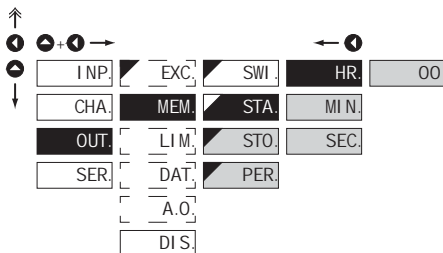
**RTC**

The lowest recording rate possible is once a day, the highest is every second. Under exceptional circumstances it is possible to set the rate to 8 times per second by entering the recording period as 00:00:00. However, this mode is not recommended due to the memory overload. Recordings are realised in a timeframe of one day and are repeated periodically every following day. Recordings can take place either inside or outside of selected time intervals. The duration of re-writing can be determined by the number of channels recorded as well as by the recording rate.

STA. Start of data logging into instrument memory

- time format HH:MM:SS

STO. Stop data logging into instrument memory

- time format HH:MM:SS

PER. Period of data logging into instrument memory

- determines the period in which values will be logged in an interval delimited by the time set under items **START** and **STOP**

- time format HH:MM:SS

- records are made on a daily basis in selected interval and period

- item not displayed if "SAVE" is selected in menu „INP. > EXT. > L.O.A.“

6.3.2c SETTING DATA LOGGING INTO INSTRUMENT MEMORY - FAST

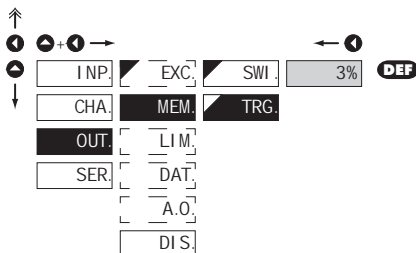
**TRG.** Setting logging data into inst. memory

- logging data into inst. memory is governed by the following selection, which determines how many percent of the memory is reserved for data logging prior to initiation of trigger impulses
- initialization is on ext. input or button
- setting in range 1..100 %
- when setting 100 %, datalogging works in the mode **ROLL** > data keep getting rewritten in cycles

1. Memory initialization

- clear memory (ext.input, button)
- LED "M" flashes, after reading TRIGGER (%) memory is permanently shining. In ROLL flashes constantly.

2. Triggering

- external input, button
- after the memory LED is full "M" turns off
- in the ROLL mode the trigger ends datalogging and LED turns off

3. Termination

- ext. input, button or reading data via RS

FAST

The memory operates on the basis of memory oscilloscope. Select an area of 0..100% of the memory capacity (100% represents 8 192 individual recordings for a single channel measurement). This area is filled cyclically up to the point when the recording starts (activated by the front panel button or by an external input). When the remaining memory capacity fills up the recording stops. A new recording is possible after the deletion of the latest recording. It is possible to abort a recording before its completion by reading out the data.

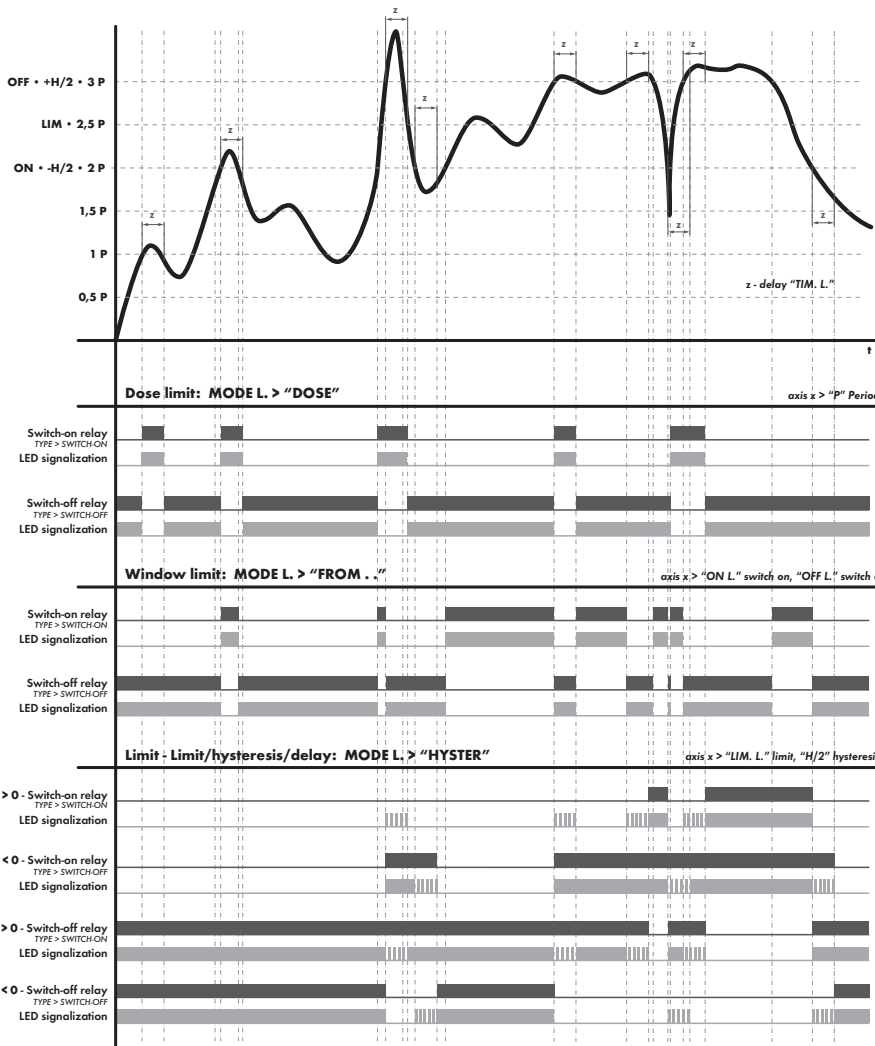

6.3.3a SELECTION OF INPUT FOR LIMITS EVALUATION

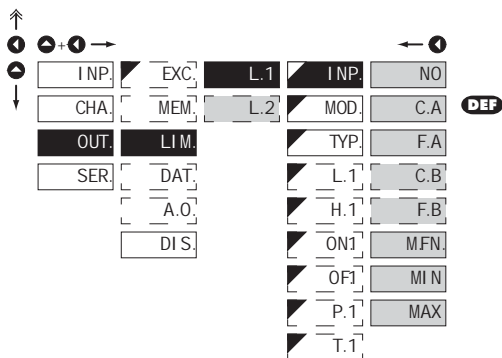

INP. Selection evaluation of limits

- selection of value from which the limit will be evaluated

- NO Limit evaluation is off
- C.A Limit evaluation from "Channel A"
- F.A Limit evaluation from "Channel A" after digital filters processing
- C.B Limit evaluation from "Channel B"
- F.B Limit evaluation from "Channel B" after digital filters processing
- MFN. Limit evaluation from "Mathematic functions"
- MI N. Limit evaluation from "Min. value"
- MAX Limit evaluation from "Max. value"

Setting is identical for „L. 2“

6. SETTING PROFI

6.3.3b SELECTION OF TYPE OF LIMIT

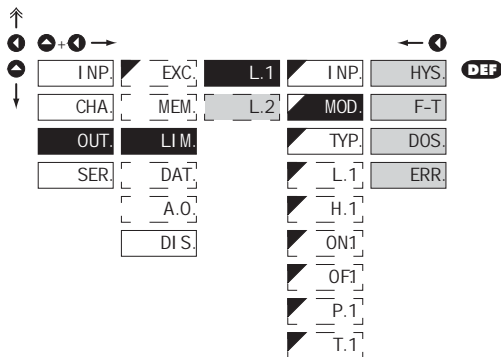

MOD. Selection the type of limit

HYS. Limit is in mode "Limit, hysteresis, delay"

- for this mode the parameters of "L. 1" are set, at which the limit will shall react, "H. 1" the hysteresis range around the limit (LIM ± 1/2 HYS) and time "T. 1" determining the delay of relay switch-on

F-T Frame limit

- for this mode the parameters are set for interval "ON1" the relay switch-on and "OF1" the relay switch-off

DOS. Dose limit (periodic)

- for this mode the parameters are set for "P. 1" determining the limit value as well as its multiples at which the output is active and "T. 2" indicating the time during which is the output active

ERR. Error indication

- output is active when error message is on



Setting is identical for „L. 2“

6.3.3c SELECTION OF TYPE OF OUTPUT

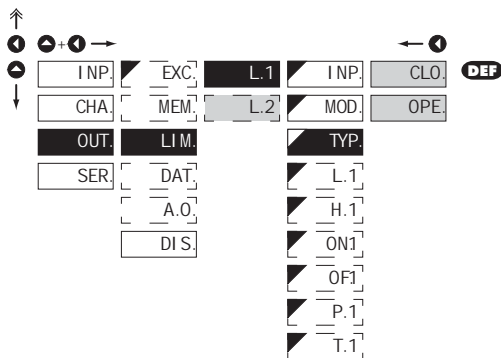

TYP. Selection of type of output

CLO. Output switches on when condition is met

OPE. Output switches off when condition is met



Setting is identical for „L. 2“

6.3.3d SETTING VALUES FOR LIMITS EVALUATION

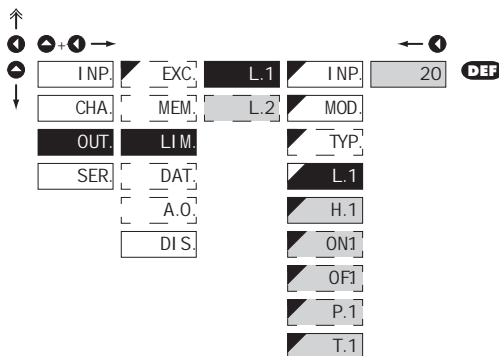

- L.1** Setting limit for switch-on
- for type "HYS."
- H.1** Nastavení hystereze
- for type "HYS."
 - indicates the range around the limit (in both directions, LIM. $\pm 1/2$ HYS.)
- ON1** Setting the outset of the interval of limit switch-on
- for type "F-T"
- OF1** Setting the end of the interval of limit switch-on
- for type "F-T"
- P.1** Setting the period of limit switch-on
- for type "DOS."
- T.1** Setting the time switch-on of the limit
- for type "HYS." and "DOS."
 - setting within the range: $\pm 0..99,9$ s
 - positive time > relay switches on after crossing the limit [L. 1] and the set time [T. 1]
 - negative time > relay switches off after crossing the limit [L. 1] and the set negative time [T. 1]

!
Setting is identical for „L. 2“

6. SETTING PROFI

6.3.4a SELECTION OF DATA OUTPUT BAUD RATE

Navigation icons: ↑, ↓, ←, →, +, -

INP	EXC	BD	06
CHA	MEM	ADD	12
OUT	LI M	AMO	24
SER	DAT	APB	48
	A.O	GSD	96 DEF
	DI S	PRO	192
			384
			576
			115
			230

BD	Selection of data output baud rate
06	Rate - 600 Baud
12	Rate - 1 200 Baud
24	Rate - 2 400 Baud
48	Rate - 4 800 Baud
96	Rate - 9 600 Baud
192	Rate - 19 200 Baud
384	Rate - 38 400 Baud
576	Rate - 57 600 Baud
115	Rate - 115 200 Baud
230	Rate - 230 400 Baud

6.3.4b SETTING INSTRUMENT ADDRESS

Navigation icons: ↑, ↓, ←, →, +, -

INP	EXC	BD	00
CHA	MEM	ADD	
OUT	LI M	AMO	
SER	DAT	APB	
	A.O	GSD	
	DI S	PRO	

ADD	Setting instrument address
	- setting in range: 0...31
	- DEF = 00
AMO	Setting instrument address - MDDBUS
	- setting in range: 1...247
	- DEF = 01
APB	Setting instrument address - PROFIBUS
	- setting in range: 1...127
	- DEF = 19

6.3.4c SELECTION OF GSD FILE FORMAT

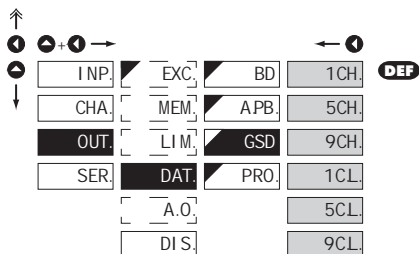

GSD	Selection of GSD file format
1CH.	1 channel
5CH.	5 channels
9CH.	9 channels
1CL.	1 channel + limit
5CL.	5 channels + limit
9CL.	9 channels + limit

6.3.4d SELECTION OF DATA OUTPUT PROTOCOL

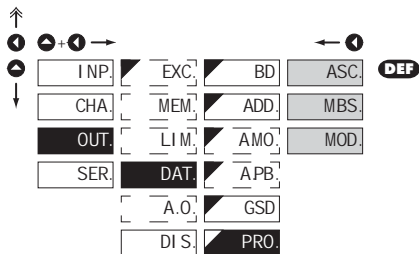

PROT.	Selection of the type of analog output
ASC.	Data protocol ASCII
MBS.	Data protocol DIN MessBus
MOD.	Data protocol MODBUS - RTU

- option is available only for RS 485

6. SETTING PROFI

6.3.5a SELECTION OF INPUT FOR ANALOG OUTPUT

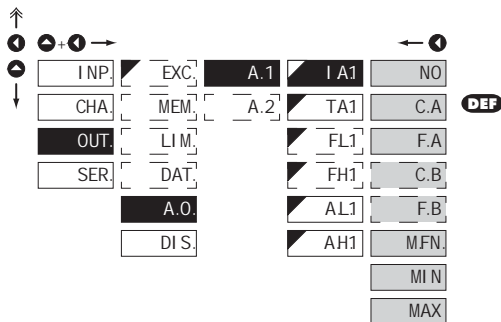

I A1 Selection evaluation analog output

- selection of value from which the analog output will be evaluated

NO	AD evaluation is off
C.A	AD evaluation from "Channel A"
F.A	AD evaluation from "Channel A" after digital filters processing
C.B	AD evaluation from "Channel B"
F.B	AD evaluation from "Channel B" after digital filters processing
M.FN.	AD evaluation from "Math. functions"
MI N	AD evaluation from "Min. value"
MAX	AD evaluation from "Max. value"



Setting is identical also for „A. 2“

6.3.5b

SELECTION OF THE TYPE OF ANALOG OUTPUT

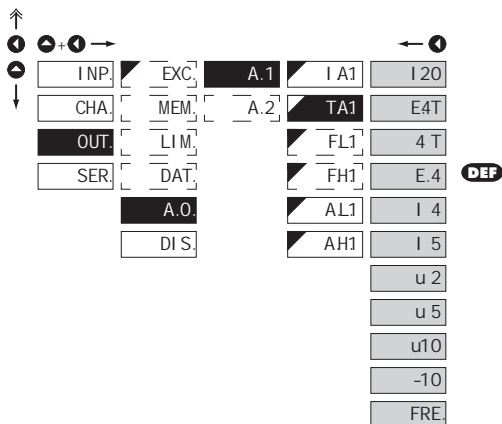
**A.1** Selection of the type of analog output

I 20 Type: 0...20 mA

E4T Type: 4...20 mA with indication

- with broken loop detection and indication of error statement (< 3,6 mA)

4 T Type: 4...20 mA with indication

- with broken loop detection (< 3,6 mA)

E.4 Type: 4...20 mA with indication

- with indic. of error statement (< 3,6 mA)

I 4 Type: 4...20 mA

I 5 Type: 0...5 mA

u 2 Type: 0...2 V

u 5 Type: 0...5 V

u10 Type: 0...10 V

-10 Type: ±10 V

FRE. Type: 0,2...2200 Hz



Setting is identical also for ,A. 2'

6. SETTING PROFI

6.3.5c SETTING THE ANALOG OUTPUT RANGE

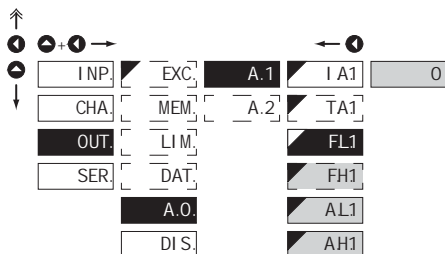

A.O. Setting the analog output range

- analog output is isolated and its value corresponds with displayed data. It is fully programmable, i.e. it allows to assign the AD limit points to two arbitrary points of the entire measuring range

FL1 Setting the beginning of the frequency range for item „MIN“

- range of the setting: 0,2...2 200 Hz

- **DEF** = 0 (-40 - RTD, T/C)

FH1 Setting the end of the frequency range for item „MAX“

- range of the setting: 0,2...2 200 Hz

- **DEF** = 100 (199 - RTD, T/C)

AL1 Assigning the display value to the beginning of the AD range

- range of the setting: -99M...999M

- **DEF** = 0 (-40 - RTD, T/C)

AH1 Assigning the display value to the end of the AD range

- range of the setting: -99M...999M

- **DEF** = 100 (199 - RTD, T/C)



Setting is identical also for „A.2“

6.3.6 SELECTION OF DISPLAY BACKLIGHT

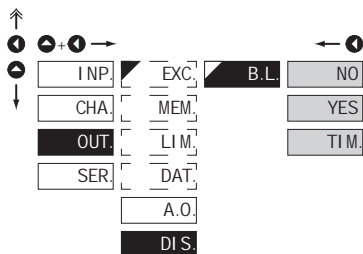

B.L. Backlight

NO Backlight is off

YES Backlight is on

TIM. Backlight is time limited

- after a key stroke the backlight is active for 80 s



6. SETTING PROFI

6.4 SETTING "PROFI" - SERVICE

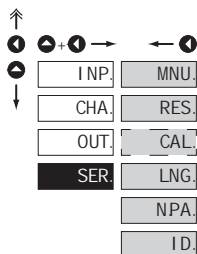

The instrument service functions are set in this menu

MNU.	Selection of menu type LIGHT/PROFI
RES.	Restore instrument manufacture setting and calibration
CAL.	Input range calibration for „DU“ version
LNG.	Language version of instrument menu
C.M.	Setting new access password
ID.	Instrument identification

6.4.1 SELECTION OF TYPE OF PROGRAMMING MENU

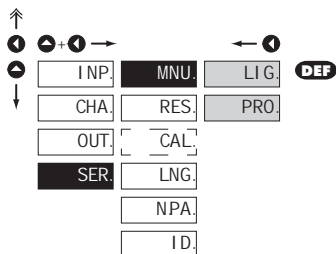

MNU. Selection of menu type - LIGHT/PROFI

- enables setting the menu complexity according to user needs and skills

LI G. Aktivní LIGHT menuActive LIGHT menu

- simple programming menu, contains only items necessary for configuration and instrument setting
- linear menu > items one after another

PRO. Active PROFÍ menu

- complete programming menu for expert users
- free menu



Change of setting is valid upon next access into menu

6.4.2 RESTORATION OF MANUFACTURE SETTING

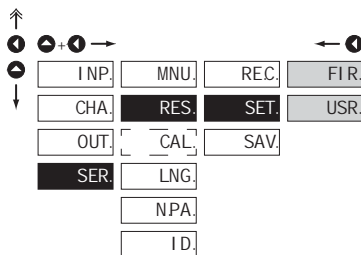
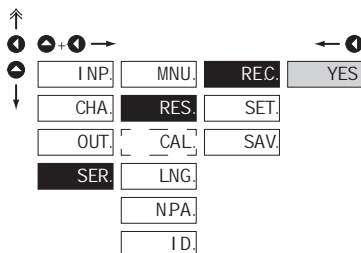
**RES.** Restoration of manufacture setting

- in the event of error setting or calibration, manufacture setting may be restored

REC. Restoration of manufacture calibration of the instrument

- prior executing the changes you will be asked to confirm your selection ,YES"

SET. Restoration of instrument manufacture setting**FIR.** Restoration of instrument manufacture setting

- generating the manufacture setting for currently selected type of instrument (items marked DEF)

USR. Restoration of instrument user setting

- generating the instrument user setting, i.e. setting stored under SER./RES./SAV.

SAV. Save instrument user setting

- storing the user setting allows the operator to restore it in future if needed



After restoration the instrument switches off for couple seconds

JOBS PERFORMED**RESTORE**

JOBS PERFORMED	RESTORE	
	CALIBRATION	SETTING
cancel USER menu rights	✓	✓
deletes table of items order in USER - LIGHT menu	✓	✓
adds items from manufacture to LIGHT menu	✓	✓
deletes data stored in FLASH	✓	✓
cancel or linearization tables	✓	✓
clears tare	✓	✓
restore manufacture calibration	✓	✗
restore manufacture setting	✗	✓

6. SETTING PROFI

6.4.3 CALIBRATION - INPUT RANGE

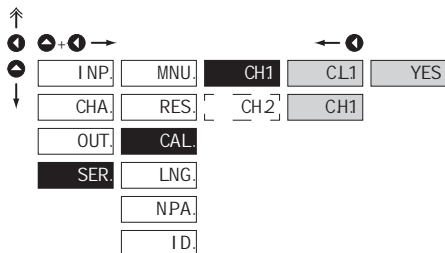
DU

CH1 Kalibrace vstupního rozsahu

- when "C.L.1" is displayed, move the potentiometer traveller to the required minimum position and confirm by „Enter”, calibration is confirmed by „YES”
- when "C.H.1" is displayed, move the potentiometer traveller to required maximum position and confirm by „Enter”, calibration is confirmed by „YES”

! This setting is identical also for „CH.2”

6.4.4 SELECTION OF INSTRUMENT MENU LANGUAGE VERSION

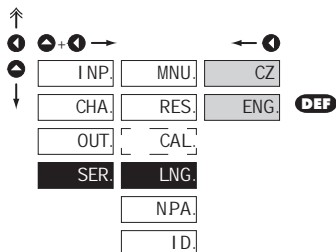

LNG. Selection of instrument menu language version

CZ Instrument menu is in Czech

ENG. Instrument menu is in English

6.4.5 SETTING NEW ACCESS PASSWORD

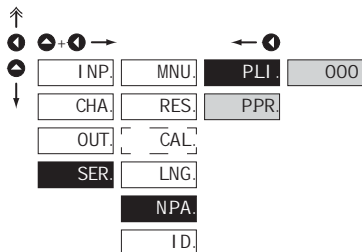

NPA. Setting new password for access to LIGHT and PROFi menu

- this option allows to change the numeric code, which blocks the access into LIGHT and PROFi menu.
- numeric code range: 0...999
- universal passwords in the event of loss: LIGHT Menu > „177” PROFi Menu > „915**”

6.4.6 INSTRUMENT IDENTIFICATION

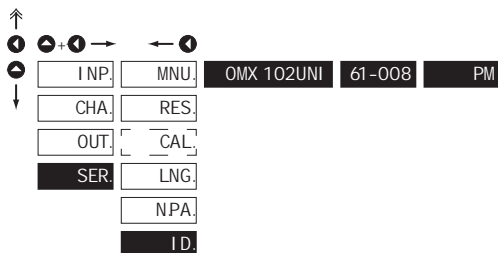
**ID.** Projection of instrument SW version

- display shows type identification of the instrument, SW number, SW version and current input setting (Mode)
- if the SW version reads a letter on first position, it is a customer SW

	Pos.	Description
IDENT.	1.	type of instrument
	2.	SW. number - version
	3.	the input type



SETTING USER

For user operation

Menu items are set by the user (Profi/Light) as per request

Access is not password protected

Optional menu structure either tree (PROFI) or linear (LIGHT)

7.0 SETTING ITEMS INTO "USER" MENU

- **USER** menu is designed for users who need to change only several items of the setting without the option to change the primary instrument setting (e.g. repeated change of limit setting)
- there are no items from manufacture permitted in **USER** menu
- on items indicated by inverse triangle  LIM 1
- setting may be performed in **LIGHT** or **PROFI** menu, with the **USER** menu then overtaking the given menu structure

Setting

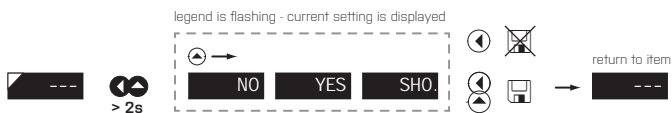

NO

item will not be displayed in USER menu

YES

item will be displayed in USER menu with editing option

SHO.

item will be solely displayed in USER menu

Setting sequence of items in "USER" menu

In compiling USER menu from active LIGHT menu the items (max. 10) may be assigned a sequence, in which they will be projected in the menu

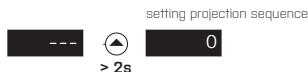

Example of ranking the order of menu items in the "USER" menu

In this example we want to have a direct access to menu items Limit 1 and Limit 2 (example show is for the Light menu, but can equally be used in the Profi menu).

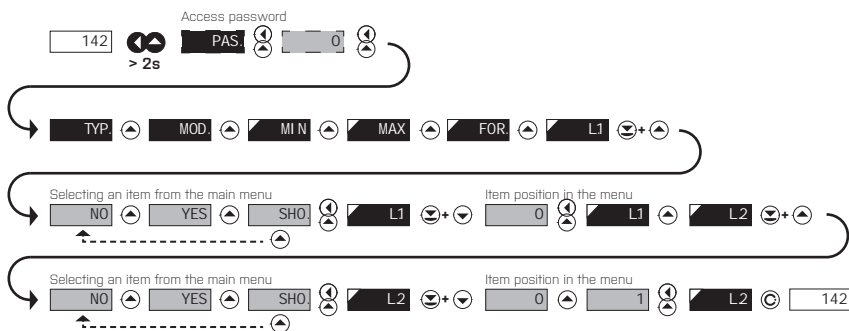

The result of this setting is that when the button is pressed, the display will read „L1“. By pressing button you confirm your selection and then you can set the desired limit value, or by pressing the button you can go to setting of „L2“ where you can proceed identically as with Limit one.

You can exit the setting by pressing the button by which you store the latest setting and pressing the button will take you back to the measuring mode

8. METHOD OF MEASURING THE CJC

Instrument with input for temperature measurement with thermocouple allows to set two types of measurement of cold junction.

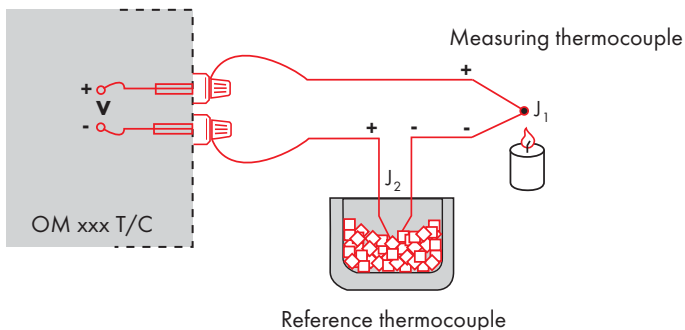

WITH REFERENCE THERMOCOUPLE

- a reference thermocouple may be located in the same place as the measuring instrument or in place with stable temperature/compensation box
- when measuring with reference thermocouple set **C01** in the instrument menu to **I N2** or **EX2**
- when using a thermostat (a compensation box or environment with constant temperature) set in the instrument menu **CJ1** its temperature (applies for setting **C01** to **EX2**)
- if the reference thermocouple is located in the same environment as the measuring instrument then set in the instrument menu **C01** to **I N2**. Based on this selection the measurement of the ambient temperature is performed by a sensor located in the instrument terminal board

WITHOUT REFERENCE THERMOCOUPLE

- inaccuracy originating from the creation of dissimilar thermocouples on the transition point terminal/conductor of the thermocouple is not compensated for in the instrument
- when measuring without reference thermocouple set **C01** in the instrument menu to **I N1** or **EX1**
- when measuring temperature without reference thermocouple the error in measured data may be as much as 10°C (applies for setting **C01** to **EX1**)

ERROR	CAUSE	ELIMINATION
ED ₋	Number is too small (large negative) to be displayed	change DP setting, channel constant setting
ED ₋	Number is too large to be displayed	change DP setting, channel constant setting
ET ₋	Number is outside the table range	increase table values, change input setting (channel constant setting)
ET ₋	Number is outside the table range	increase table values, change input setting (channel constant setting)
EI ₋	Input quantity is smaller than permitted input quantity range	change input signal value or input (range) setting
EI ₋	Input quantity is larger than permitted input quantity range	change input signal value or input (range) setting
EHW.	A part of the instrument does not work properly	send the instrument for repair
EEE	Data in EEPROM corrupted	perform restoration of manufacture setting, upon repeated error statement send instrument for repair
EDT.	Data in EEPROM outside the range	perform restoration of manufacture setting, upon repeated error statement send instrument for repair
ECL.	Memory was empty (presetting carried out)	upon repeated error statement send instrument for repair, possible failure in calibration
EOu.	Analogue input/output current loop disconnected	check wire connection

10. DATA PROTOCOL



The instruments communicate via serial line RS232 or RS485. For communication they use the ASCII protocol. Communication runs in the following format:

ASCII: 8 bit, no parity, one stop bit

DIN MessBus: 7 bit, even parity, one stop bit

The transfer rate is adjustable in the instrument menu. The instrument address is set in the instrument menu in the range of 0 ÷ 31. The manufacture setting always presets the ASCII protocol, rate of 9600 Baud, address 00. The type of line used - RS232 / RS485 - is determined by an output board automatically identified by the instrument.

The commands are described in specifications you can find at www.orbit.merret.eu or SW OM Link.

DETAILED DESCRIPTION OF COMMUNICATION VIA SERIAL LINE

EVENT	TYPE	PROTOCOL	TRANSMITTED DATA	
Data solicitation (PC)	232	ASCII	# A A A <CR>	
		MessBus	No - data is transmitted permanently	
	485	ASCII	# A A A <CR>	
		MessBus	<SADR> <ENQ>	
Data transmission (instrument)	232	ASCII	> D [D] [D] [D] [D] [D] [D] [D] [D] [D] [D] [D] <CR>	
		MessBus	<STX> D [D] [D] [D] [D] [D] [D] [D] [D] [D] [D] [D] <ETX> <BCC>	
	485	ASCII	> D [D] [D] [D] [D] [D] [D] [D] [D] [D] [D] [D] <CR>	
		MessBus	<STX> D [D] [D] [D] [D] [D] [D] [D] [D] [D] [D] [D] <ETX> <BCC>	
Confirmation of data acceptance (PC) - OK	485	MessBus	<DLE> 1	
Confirmation of data acceptance (PC) - Bad			<NAK>	
Sending address (PC) prior command			<EADR> <ENQ>	
Confirmation of address (instrument)			<SADR> <ENQ>	
Command transmission (PC)	232	ASCII	# A A N P [D] [D] [D] [D] [D] [D] [D] [D] <CR>	
		MessBus	<STX> S N P [D] [D] [D] [D] [D] [D] [D] [D] <ETX> <BCC>	
	485	ASCII	# A A N P [D] [D] [D] [D] [D] [D] [D] [D] <CR>	
		MessBus	<STX> S N P [D] [D] [D] [D] [D] [D] [D] [D] <ETX> <BCC>	
Command confirmation (instrument)	232	ASCII	OK	! A A <CR>
			Bad	? A A <CR>
		Messbus		No - data is transmitted permanently
		485	ASCII	OK
	Bad			? A A <CR>
	MessBus		OK	<DLE> 1
			Bad	<NAK>
	Instrument identification			# A A 1 Y <CR>
HW identification			# A A 1 Z <CR>	
One-time transmission			# A A 7 X <CR>	
Repeated transmission			# A A 8 X <CR>	

LEGEND

SIGN	RANGE	DESCRIPTION
#	35 23 _h	Command beginning
A	A 0...31	Two characters of instrument address [sent in ASCII - tens and units, e.g. '01', '99' universal]
<CR>	13 0D _h	Carriage return
<SP>	32 20 _h	Space
N, P		Number and command - command code
D		Data - usually characters '0'...'9', '*', ';', ':', '[', ']' - dp. and {} may prolong data
R	30 _h ...3F _h	Relay and tare status
!	33 21 _h	Positive confirmation of command [ok]
?	63 3F _h	Negative confirmation of command [point]
>	62 3E _h	Beginning of transmitted data
<STX>	2 02 _h	Beginning of text
<ETX>	3 03 _h	End of text
<SADR>	adresa +60 _h	Prompt to send from address
<EADR>	adresa +40 _h	Prompt to accept command at address
<END>	5 05 _h	Terminate address
<DLE>1	16 49 10 _h , 31 _h	Confirm correct statement
<NAK>	21 15 _h	Confirm error statement
<BCC>		Check sum -XOR

RELAY, TARE

SIGN	RELAY 1	RELAY 2	TARE	CHANGE
P	0	0	0	0
Q	1	0	0	0
R	0	1	0	0
S	1	1	0	0
T	0	0	1	0
U	1	0	1	0
V	0	1	1	0
W	1	1	1	0

Relay status is generated by command #AA6X <CR>.

The instrument immediately returns the value in the format >HH <CR>, where HH is value in HEX format and range 00_h...FF_h. The lowest bit stands for „Relay 1“, the highest for „Relay 2“

11. TABLE OF SIGNS



The instrument allows to add two descriptive characters to the classic numeric formats (at the expense of the number of displayed places). The setting is performed by means of a shifted ASCII code. Upon modification the first two places display the entered characters and the last two places the code of the relevant symbol from 0 to 95. Numeric value of given character equals the sum of the numbers on both axes of the table.

Description is cancelled by entering characters with code 00

	0	1	2	3	4	5	6	7		0	1	2	3	4	5	6	7
0		Q	"	#	\$	%	&	'	0	!	"	#	\$	%	&	'	
8	:	;	*	+	,	-	.	/	8	()	*	+	,	-	.	/
16	0	1	2	3	4	5	6	7	16	0	1	2	3	4	5	6	7
24	8	9	VA	Vr	<	=	>	?	24	8	9	VA	Vr	<	=	>	?
32	P	R	B	C	D	E	F	G	32	@	A	B	C	D	E	F	G
40	H	I	J	K	L	M	N	O	40	H	I	J	K	L	M	N	O
48	P	Q	R	S	T	U	V	W	48	P	Q	R	S	T	U	V	W
56	X	Y	Z	[\]	^	_	56	X	Y	Z	[\]	^	_
64	`	a	b	c	d	e	f	g	64	`	a	b	c	d	e	f	g
72	h	i	j	k	l	m	n	o	72	h	i	j	k	l	m	n	o
80	p	q	r	s	t	u	v	w	80	p	q	r	s	t	u	v	w
88	x	y	z	{		}	~		88	x	y	z	{		}	~	



12. TECHNICAL DATA



INPUT - DMX 102UNI

No. of inputs: up to 2

Range:			DC
±90 mA	< 200 mV		Input 5
±180 mA	< 200 mV		Input 5
±30 mV	> 10 MΩ		Input 3
±60 mV	> 10 MΩ		Input 3
±1000 mV	> 10 MΩ		Input 3
±20 V	1,25 MΩ		Input 1
±40 V	1,25 MΩ		Input 1
±80 V	1,25 MΩ		Input 1

Range:			PM
±5 mA	< 200 mV		Input 5
±20 mA	< 200 mV		Input 5
4...20 mA	< 200 mV		Input 5
±2 V	> 10 MΩ		Input 1
±5 V	1,25 MΩ		Input 1
±10 V	1,25 MΩ		Input 1

Range:			OHM
0...100 Ω			
0...300 Ω			
0...15 kΩ			
0...3,0 kΩ			
0...24,0 kΩ			
0...30,0 kΩ			

Connection: 2, 3 or 4 -wire

EU • Pt xxxx	-50°...450°C
US • Pt 100	-50°...450°C
RU • Pt 50	-200°...1 100°C
RU • Pt 100	-200°...450°C
Cu 100/4 280	-200°...200°C
Cu 100/4 260	-50°...200°C
Ni xxxx	-50°...250°C

Typ Pt: EU > 100/500/1 000 Ω, with 3 850 ppm/°C
 US > 100 Ω, with 3 920 ppm/°C
 RU > 50/100 Ω with 3 910 ppm/°C

Typ Ni: Ni 1 000/ Ni 10 000 with 5 000/6 180 ppm/°C
 Typ Cu: Cu 50/Cu 100 with 4 260/4 280 ppm/°C

Connection: 2, 3 or 4 -wire

Type:		T/C
J (Fe-CuNi)	-100°...900°C	
K (NiCr-Ni)	-100°...1 300°C	
T (Cu-CuNi)	-200°...400°C	
E (NiCr-CuNi)	-100°...800°C	
B (PtRh30-PtRh6)	700°...1 820°C	
S (PtRh10-Pt)	100°...1 760°C	
R (Pt13Rh-Pt)	100°...1 760°C	
N (Omegaalloy)	-0°...1 300°C	
L (Fe-CuNi)	-100°...900°C	

Voltage of lin. pot. 2,5 VDC/6 mA
 min. potentiometer resistance is 500 Ω

INPUT - DMX 102DC

No. of inputs:	1		
Range:	±1 A	< 200 mV	Input 5
	±5 A	< 200 mV	Input 5
	±25 V	1,25 MΩ	Input 1
	±50 V	1,25 MΩ	Input 1
	±100 V	1,25 MΩ	Input 1
	±200 V	1,25 MΩ	Input 1
	±400 V	1,25 MΩ	Input 1

PROJECTION

Display: LCD with backlight,
 2x 3 characters + 2x description (3 characters)

Projection -99M..999M

Decimal point: adjustable - in menu

INSTRUMENT ACCURACY

TK: 50 ppm/°C

Pfesnost: ±0,15 % of range + 1 digit
 ±0,3 % of range + 1 digit

Accuracy of cold junction measur.: ±1,5°C

Rate: 0,5...160 measurements/s

Přetížitelnost: 2x; 10x (t < 100 ms) not for > 200 V and 5 A,

Linearisation: by linear interpolation in 50 points
 - solely via QM Link

Digital filters: Averaging, Floating average, Exponential filter,
 Rounding

Comp. of conduct: max. 40 Ω/100 Ω

Comp. of cold junc.: adjustable

Functions: 0°...99°C or automatic
 Tare - display resetting
 Hold - stop measuring (at contact)
 Lock - control key locking
 MM - min/max value
 Mathematic functions

QM Link: company communication interface for setting,
 operation and update of instrument SW

Watch-dog: reset after 400 ms

Calibration: at 25°C and 40% of r.h.

COMPARATOR

Type:	digital, adjustable in menu, response time < 50 ms
Mode:	Hyster, F-T, Dosing, Error
Limits:	999, resp -99M...999M
Hysteresis:	0...999, resp. 999 k
Delay:	0...99,9 s
Výstup:	2x relays with switch-on contact (Form A)
Relay:	1/8 HP 277 VAC, 1/10 HP 125 V, Pilot Duty D300

DATA OUTPUTS

Protocols:	ASCII, DIN MessBus, MODBUS, PROBUS
Data format:	8 bit + no parity + 1 stop bit (ASCII) 7 bit + even parity + 1 stop bit (MessBus)
Rate:	600...230 400 Baud 9 600 Baud...12 Mbaud (PROFIBUS) 1 Mbaud (CAN)
RS 232:	isolated, two-way communication
RS 485:	isolated, two-way communication, addressing (max. 31 instruments)
PROFIBUS	Data protocol SIEMENS
Ethernet:	10/100BaseT, secure communication, POP3, ftp, http
USB	not-isolated, two-way communication

ANALOG OUTPUTS

Type:	isolated, dual, programmable with 16 bits D/A convertor, analog output corresponds with displayed data, type and range are adjustable
Non-linearity:	0,1% of range
TC:	15 ppm/°C
Rate:	response to change of value < 1 ms
Voltage:	0...2 V/5 V/10 V/±10 V
Current:	0...5/20 mA/4...20 mA - compensation of conduct to 500 Q/12 V
Frequency:	isolated, programmable, open collector with the option of external supply (max. 40 V) via interval resistance (5k6), 0,2...2200 Hz

MEASURED DATA RECORD

Type RTC:	time-controlled logging of measured data into instrument memory, allows to log up to 250 000 values
Type FAST:	fast data logging into instrument memory, allows to log up to 8 000 values at a rate of 40 records/s
Transmission:	via USB or data output RS 232/485 or via OM Link

EXCITATION

Adjustable 5/12/17/24 VDC, max. 2.5 W, isolated

POWER SUPPLY

Options:
10...30 V AC/DC, max. 13,5 VA, PF ≥ 0,4, I_{trip} < 40 A/1 ms, isolated
- fuse inside (T 4000 mA)
80...250 V AC/DC, max. 13,5 VA, PF ≥ 0,4, I_{trip} < 40 A/1 ms, isolated
- fuse inside (T 630 mA)

MECHANIC PROPERTIES

Material: PA 66, incombustible UL 94 V-I, blue
Dimensions: 113 x 98 x 35 mm
Installation: to DIN rail, width 35 mm

OPERATING CONDITIONS

Connection: connector terminal board, conductor cross-section <1,5 mm² /-<2,5 mm²
Stabilisation period: within 15 minutes after switch-on
Working temp.: -20°...60°C
Storage temp.: -20°...85°C
Cover: IP20
Construction: safety class I
Overvoltage cat.: EN 61010-1, A2
Dielectric strength: 4 kVAC after 1 min between supply and input
4 kVAC after 1 min between supply and data/analog output
4 kVAC after 1 min between supply and relays
3,75 kVAC after 1 min between input and data/analog output
3,75 kVAC after 1 min between inputs
Insulation resist.: for pollution degree II, measurement cat. III
supply, input, output > 600 V (Zi), 300 V (Di)
EMC: EN 61326-1
Seismic resistance: IEC 980: 1993, par. 6

* values apply for resistance load

13. INSTRUMENT DIMENSIONS AND INSTALLATION



Front view

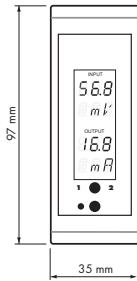

Installation to DIN rail of 35 mm width

Side view

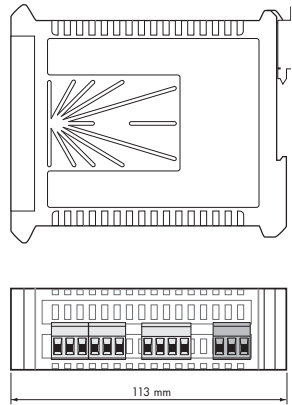

Product	OMX 102UNI	DC
Type	
Manufacturing No.	
Date of sale	

GUARANTEE

A guarantee period of 60 months from the date of sale to the user applies to this instrument.
Defects occurring during this period due to manufacture error or due to material faults shall be eliminated free of charge.

For quality, function and construction of the instrument the guarantee shall apply provided that the instrument was connected and used in compliance with the instructions for use.

The guarantee shall not apply to defects caused by:

- mechanic damage
- transportation
- intervention of unqualified person incl. the user
- unavoidable event
- other unprofessional interventions

The manufacturer performs guarantee and post.guarantee repairs unless provided for otherwise.

YEARS



RusAutomation

ООО "РусАвтоматизация"

454010 г. Челябинск, ул. Гагарина 5, оф. 507
 тел. 8-800-775-09-57 (звонок бесплатный),
 тел.: (351)799-54-26, тел./факс (351)211-64-57
info@rusautomation.ru; www.rusautomation.ru
[русавтоматизация.pdf](#)



Company: **ORBIT MERRET, spol. s r.o.**
Klánova 81/141, 142 00 Prague 4, Czech Republic, IDNo.: 00551309

Manufactured: **ORBIT MERRET, spol. s r.o.**
Vodňanská 675/30, 198 00 Prague 9, Czech Republic

declares at its explicit responsibility that the product presented hereunder meets all technical requirements, is safe for use when utilised under the terms and conditions determined by ORBIT MERRET, spol.s r.o. and that our company has taken all measures to ensure conformity of all products of the types referred-to hereunder, which are being brought out to the market, with technical documentation and requirements of the appurtenant Czech statutory orders.

Product: Programmable panel instrument

Type **DMX 102**

Version: DC, UNI, PWR, UQC, T

That has been designed and manufactured in line with requirements of:

Statutory order no. 17/2003 Coll., on low-voltage electrical equipment (directive no. 73/23/EHS)
Statutory order no. 616/2006 Coll., on electromagnetic compatibility (directive no. 2004/108/EHS)

The product qualities are in conformity with harmonized standard:

El. safety: EN 61010-1
EMC: EN 61326-1
Electronic measuring, control and laboratory devices – Requirements for EMC "Industrial use"
EN 60131, chap. 14 and chap. 15, EN 50130-4, chap. 7, EN 50130-4, chap. 8, [EN 61000-4-1, ed. 2],
EN 50130-4, chap. 9 [EN 61000-4-2], EN 50130-4, chap. 10, [EN 61000-4-3, ed. 2], EN 50130-4, chap. 11 [EN 61000-4-6],
EN 50130-4, chap. 12, [EN 61000-4-4, ed. 2], EN 50130-4, chap. 13 [EN 61000-4-5], EN 61000-4-8, EN 61000-4-9,
EN 61000-6-1, EN 61000-6-2, EN 65022, chap. 5 and chap. 6

Seismic resistance: IEC 980: 1993, par. 6

The product is furnished with CE label issued in 2014

As documentation serve the protocols of authorized and accredited organizations:

EMC MD CR, Testing institute of technical devices, protocol no. 80/6-46/2006 of 15/01/2014
MD CR, Testing institute of technical devices, protocol no. EMI.80/6-333/2006 of 15/01/2014
Seismic resistance VDP-026 Stemberk, protocol no.: 6430-16/2007 of 07/02/2007 03/03/2014

Place and date of issue: Prague, 5. Februar 2014

Miroslav Hackl v.r.
Company representative

Assessment of conformity pursuant to §22 of Act no. 22/1997 Coll. and changes as amended by Act no.71/2000 Coll. and 206/2002 Coll