

INSTRUCTION MANUAL



THERMAL FLOW SENSOR TFS-35

CONTENTS

1. Basic description	4
2. Dimensional drawing	5
3. Installation instructions	6
4. Mechanical mounting	6
5. Electrical connection	8
6. Settings	10
6.1. Setting the flow rate range	10
6.2. Setting the switching points	11
6.3. Adjusting the mode of limit outputs for switching on (O) /switching off (C)	12
6.4. Reset to factory default	12
6.5. Factory setting	12
6.6. Incorrect setting	12
7. Function and status indication	13
8. Order code	14
9. Correct specification examples	14
10. Accessories	14
11. Safety, protection and compatibility	15
12. Use, manipulation and maintenance	15
13. General conditions and warranty	16
14. Marking of labels	17
15. Technical specifications	18
16. Packing, shipping and storage	19

USED SYMBOLS

To ensure maximum safety of control processes, we have defined the following safety instructions and information. Each instruction is labelled with the appropriate pictogram.



Alert, warning, danger

This symbol informs you about particularly important instructions for installation and operation of equipment or dangerous situations that may occur during the installation and operation. Not observing these instructions may cause disturbance, damage or destruction of equipment or may cause injury.



Information

This symbol indicates particularly important characteristics of the device.



Note

This symbol indicates helpful additional information.

SAFETY



All operations described in this instruction manual have to be carried out by trained personnel or by an accredited person only. Warranty and post warranty service must be exclusively carried out by the manufacturer.

Improper use, installation or set-up of the sensor can lead to crashes in the application.

The manufacturer is not responsible for improper use, loss of work caused by either direct or indirect damage, and for expenses incurred at the time of installation or during the period of use of the level sensors.

1. BASIC DESCRIPTION

Thermal flow sensor - TFS-35 is a compact measuring device intended for industrial use for flow sensing of liquid media and for monitoring of their temperature when installed in a pipe. The sensor may be installed in plastic or metal pipes. Suitable for monitoring filling, cooling or lubricating media and their temperatures. Flow rate is indicated by means of a bar graph (5 green LEDs). Output (flow rate and temperature) switching indicator by means of LED (orange and yellow).

Simple configuration using a magnetic pen. Sensor is made in a stainless steel design. Quick and simple installation thanks to simple construction.

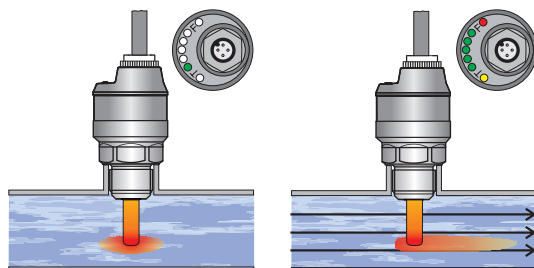

2. DIMENSIONAL DRAWING

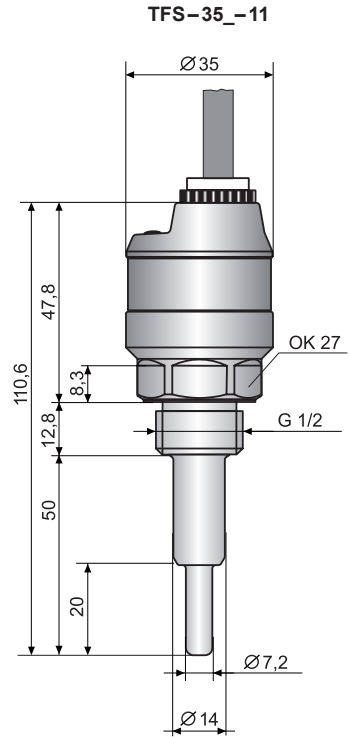
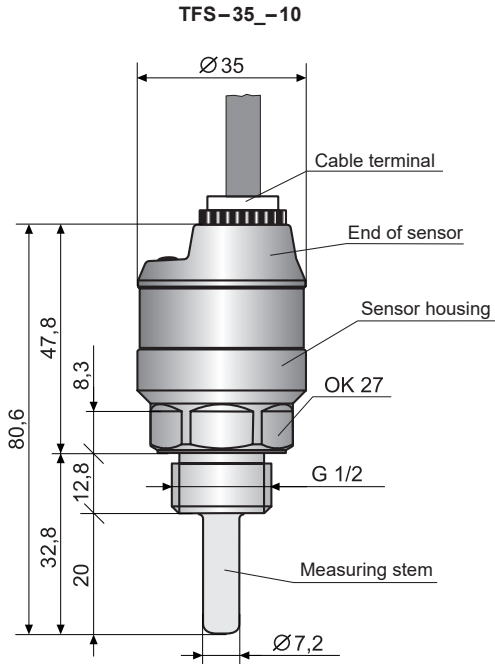

Variant „A“ with short stainless steel terminal

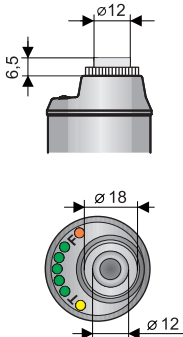

Variant „B“ with plastic threaded terminal

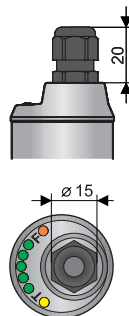

Variant „C“ with connector M12

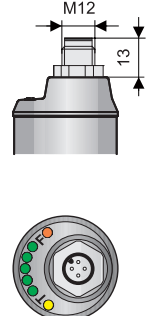

Variante „V“ with plastic terminal with spiral relief – in case of increased mechanical strain on the cable.

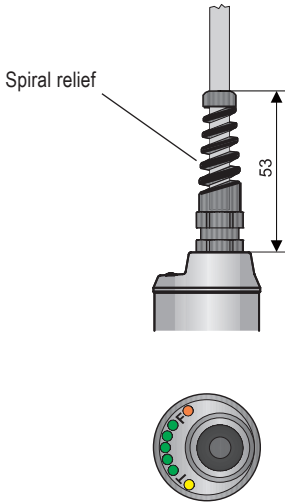

Variante „H“ with terminal for protected hoses - for use in outdoor environments or in areas with increased moisture.

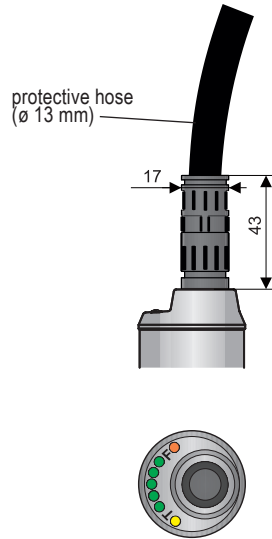

3. INSTALLATION INSTRUCTIONS

Please follow next 3 steps:

- **MECHANICAL MOUNTING - SEE CHAPTER 4**
- **ELECTRICAL CONNECTION - SEE CHAPTER 5**
- **SETTINGS - SEE CHAPTER 6**

4. MECHANICAL MOUNTING

The sensor must be installed with the sensor stem completely flooded.

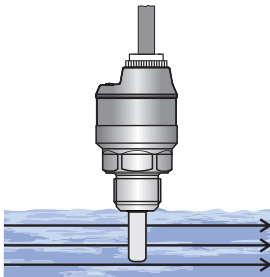

The sensor must be located in such a way that the tip of the sensor stem is at least 13 mm away from the pipe wall.

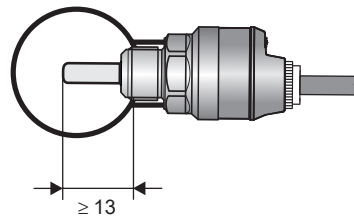
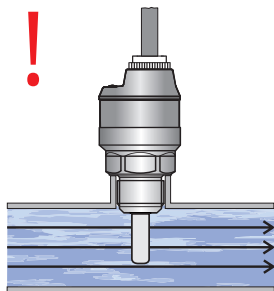

Fig. 1: Conditions for installing the sensor in a pipeline

The sensor is installed on a horizontal pipe from above when the pipe is completely flooded.



The recommended installation location is in the rising parts of the pipe system.

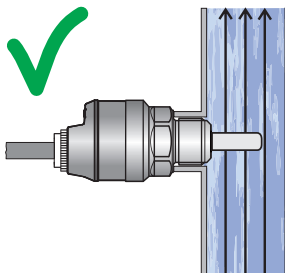
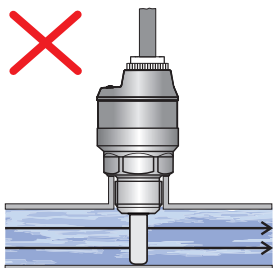

Fig. 2: Suitable places for installing the sensor in the pipeline

The tip of the sensor stem must not be touching the pipe wall.



Installation is not recommended in parts of the pipe system that may become aerated (highest parts of the pipe system, horizontal areas with open ends).

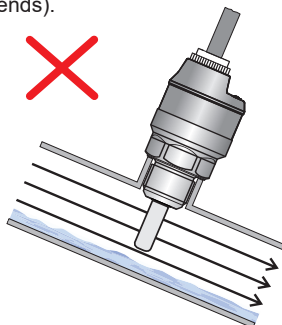

Fig 3: Non suitable places for installing the sensor in the pipeline



When measuring very low flow rates in water pipe systems, where there is a risk of dirt accumulating on the stem of the sensor, it is recommended to install it from the side of the pipe.

Disruptive elements cause the media to swirl, which reduces measuring accuracy. For this reason, the sensor installation location is selected so that there are calming direct pipe segments before and after the sensor. A direct segment of length 5...10 DN is recommended before the sensor and a direct segment of length 3...5 DN behind it. Disruptive elements are understood to mean bends, elbows, valves, reductions, other sensors, etc.

The sensor is screwed into a threaded sleeve in the pipe. For tightening, a 27 mm open end wrench must be used. The tightening torque must be selected respecting the used seal and the working overpressure in the pipe system.

The sensitivity of the sensor depends on its position relative to the flow direction. The four basic position and their characteristics are listed below.



Positions relative to the flow direction:

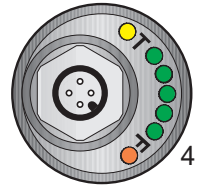
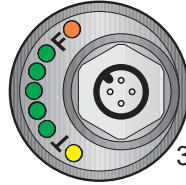
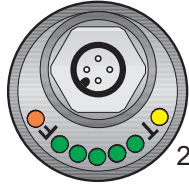
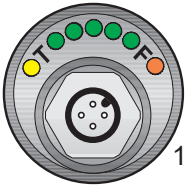

Optimal positions are no. 1 and no. 2. In these positions, the signal from the sensor is not dependent on the flow direction and sensitivity corresponds to factory settings. The lighting up of individual LED diodes on the bar graph is practically linear relative to the flow rate..

In position 3, the sensor is more sensitive to small flow rates, the ability to differentiate large flow rates is limited.

In position no. 4, the sensor is able to detect larger flow rates well, the sensitivity to small flow rates is limited.

5. ELECTRICAL CONNECTION



Electrical connection can only be made in a voltage-free state!

A sensor with PNP type of outputs can be loaded only by resistive or inductive loads. The positive pole of the supply voltage (+U) is connected to the brown wire *BN* or *pin connector no.1*, the negative pole (0 V) is connected to the blue wire *BU* or *pin connector no.3*. Flow rate load on the black wire *BK* or *pin connector no.4* and temperature load on the white wire *WH* or *pin connector no.2*. The capacitive loads and low resistance loads (e.g. bulb) are evaluated by the sensor as a short circuit.

Wiring diagrams are provided in the figures below.

Flow sensor TFS-35 with a type A, B, V or H cable terminal, is connected to the assessment units permanently by a connection cable, see. Dimensional drawings.

The TFS-35 flow sensor with connection method type C (see Dimensional drawings) is connected to the assessment units by means of a connector socket with a pressed-in cable, or by means of a detachable connector socket without a cable (e.g. ELWIKA), see accessories. In this case the cable is connected to the inside pins of the socket according to the figure below. The recommended diameter of this cable when using ELWIKA connectors is 4 to 6 mm (the recommended wire cross-sectional area is 0.5 to 0.75 mm²).

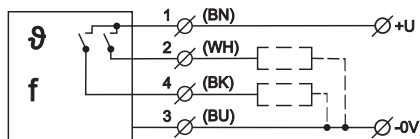

Fig. 4: Connection of flow sensor TFS-35_...-PFPT

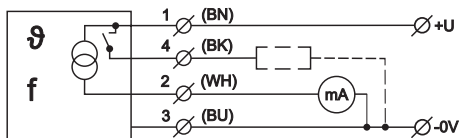

Fig. 5: Connection of flow sensor TFS-35_...-IFPF and TFS-35_...-IFPT

Connection of outputs in variant PFPT

Limit flow rate output - black wire of cable (BK),
- or pin 4 of connector.
Limit temperature output - white wire of cable (WH),
- or pin 2 of connector.

Connection of outputs in variant IFPF (IFPT)

Analog flow rate output - white wire of cable (WH),
- or pin 2 of connector.
Limit flow rate (temper.) output - black wire of cable (BK),
- or pin 4 of connector..

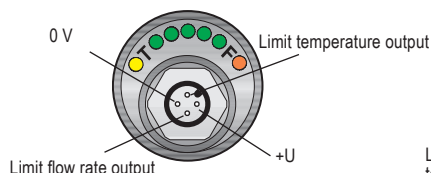

Fig. 6: Connector of flow sensor TFS-35_...-PFPT

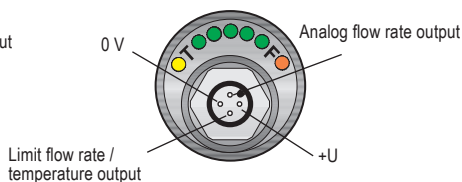

Fig. 7: Connector of flow sensor TFS-35_...-IFPF and TFS-35_...-IFPT

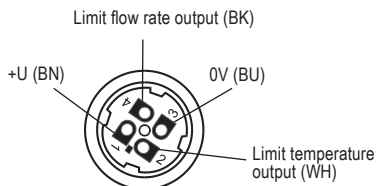

Fig. 8: Inside view of the connector socket (variant "C-PFPT")

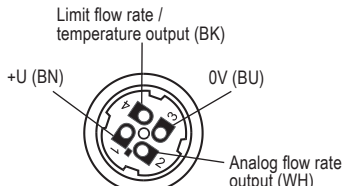

Fig. 9: Inside view of the connector socket (variant "C-IFPF(P)")

Legend:

BN - brown BK - black
WH - white BU - blue



The source of the power voltage must comprise of a stabilised safe low power source with galvanic separation. In the event that a switch-mode power supply is used, it is essential that its construction effectively suppresses common mode interference on the secondary side. In the event that the switch-mode power supply is equipped with a PE safety terminal, it must be unconditionally grounded! In the event that the flow sensor is installed in an outdoor environment at a distance greater than 20 m from the outdoor switchboard, or from an enclosed building, it is necessary to supplement the electrical cable leading to the flow sensor with suitable overvoltage protection.

In the event of strong ambient electromagnetic interference, paralleling of conductors with power distribution, or for distribution to distances over 30 m, we recommend using a shielded cable and grounding the shielding on the side of the power source.

6. SETTINGS

Settings are performed by placing the magnetic pen on to the sensitive spot marked „T“ or „F“ located between the LEDs. In this way, the minimum and maximum flow rate, flow rate switching point, temperature switching point, switching modes (O, C) are set or the factory setting are restored. An incorrect setting is indicated by the green LEDs gradually turning on and off, going from the centre to the edges. Information on settings of the sensor is provided in the user's manual.

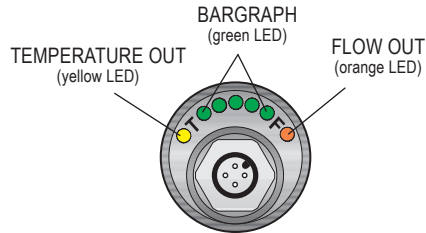

Fig. 10: Top view of the control sensor elements

PROCEDURE FOR SETTING THE FLOW SENSOR TFS-35

Connect the sensor to the power supply and wait for the sensor temperature to stabilise (during this time the sensor flashes with all its green LED diodes, then the sensor automatically pass to the measuring mode).

6.1. SETTING THE FLOW RATE RANGE

a) Setting the minimum flow rate

1. Flood the pipe system containing the sensor and stop the flow.
2. Wait at least 15 seconds (maximum response time).
3. Place the magnetic pen on to „T“ for a period **longer than 5 seconds** (the yellow LED and all the green LEDs are lit, which then gradually turn off one by one; finally the yellow LED will flash three times).

This saves the setting for the minimum flow rate.

4. If the sensor is equipped with current output, this output will be set on value 4 mA.

b) Setting the maximum flow rate

1. Flood the pipe system containing the sensor and set the flow to maximum.
2. Wait at least 15 seconds (maximum response time).
3. Place the magnetic pen on to „F“ for a period **longer than 5 seconds** (the orange LED is lit, the green LEDs light up one by one; finally the orange LED flashes three times).

This saves the setting for the maximum flow rate.

4. If the sensor is equipped with current output, this output will be set on value 20 mA.

6.2. SETTING THE SWITCHING POINTS

a) Setting the flow rate switching point (only in variant PFPT, IFPF):

1. By shortly placing the magnetic pen on the (sensitive) spot „F“ to move the flow rate switching point.
2. This switching point is indicated by one of the five green LEDs.
3. When the last LED is reached, the point moves back to the first LED when the is again.



Example: if the flow rate switching point is set to the 3rd LED, then the flow rate output switches (in the case of setting O) when at least such a flow rate is achieved, which lights the 3rd LED on the bar graph..

b) Setting the temperature switching point (only in variant PFPT, IFPT)

1. The magnetic pen „T“ to move the temperature switching point.
2. This switching point is indicated by one of the five green LEDs.
3. When the last LED is reached, the point moves back to the first LED when the is again.
4. The temperatures at which the output temperature is switched are:

- 15 °C first green LED
- 30 °C second green LED
- 45 °C third green LED
- 60 °C fourth green LED
- 75 °C fifth green LED

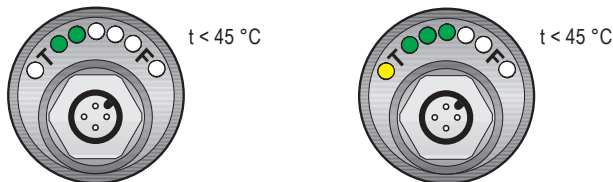

Example: if the temperature switching point is set to the 3rd LED, then the temperature output switches (in the case of setting O) when a temperature of 45 °C is reached.



The sensor has by principle of function a reaction time in the order of a few seconds.

If the sensor is set to switch at the 1st LED on the bar graph, then limit output reacts faster to flow being started and reacts slower to flow being stopped.

If the sensor is set to switch at the 5th LED on the bar graph, then limit output reacts slower to flow being started and reacts faster to flow being stopped.

If the sensor is set for switching at the 3rd LED on the bar graph, then the reaction time for the starting and stopping of flow is approximately the same.

6.3. ADJUSTING THE MODE OF LIMIT OUTPUTS FOR SWITCHING ON (O) /SWITCHING OFF (C)

If there are two limit outputs installed (version PFPT), both the outputs are either switching on (O), or both outputs are switching off (C). This means that in the event of switching on setting (O) the output flow switches on with an increase of flow speed above the set limit and switches off with a decrease below this threshold. In the case of switching off setting (C), the output behaves in reverse (switches off with flowrate increase). With the (O) setting, the temperature output switches on when the temperature exceeds the set limit. In case of (C) setting, the output behaves in reverse (switches off with temperature increase). If the sensor is equipped with a single limit output (versions IFPF or IFPT), the settings for this single output apply. (Continuous output remains not affected by this setting).

The sensor is factory set to switching mode (O); If this setting is desired, skip the following steps.

a) Setting the sensor to mode (C)

1. Disconnect the sensor from the power source (e.g. by disconnecting the connector).
2. Place the magnetic pen the „T“ in the voltage-free state and hold the magnetic pen pressed the when connecting the power supply. This is signalled by the yellow LED being lit.
3. Now it is possible to take the magnetic pen away, which is confirmed by the yellow LED flashing three times. All the other settings of the sensor remain unchanged. When the magnetic pen is taken away, the sensor goes into the temperature stabilisation mode and then to the measurement mode.
4. Repeating this procedure will set the switching mode (O) again.

6.4. RESET TO FACTORY DEFAULT

If necessary, it is possible to restore factory default.

1. Disconnect the sensor from the power source (e.g. by disconnecting the connector).
2. Place the magnetic pen the „F“ in the voltage-free state and hold the magnetic pen pressed on the when connecting the power supply. This is signalled by the orange LED being lit.
3. Now it is possible to take the magnetic pen away, which is confirmed by the orange LED flashing three times.
4. When the magnetic pen is taken away, the sensor is restored to the factory setting, see table on page 17.

6.5. FACTORY SETTING



1. The limit outputs are set as switching on (O) outputs.
2. The sensor is set to sense the water in the range of 0 to 100 cm/sec (setting of minimum and maximum flowrate); if it is fitted with the continuous output (IFPF; IFPT), this corresponds to the current output 4 to 20 mA.
3. The switching point of the flow (PFPT, IFPF) is set for switching on after achieving the 3rd LED.
4. The switching point of the temperature (PFPT, IFPT) is set to the 3rd LED (switching after a temperature of 45 °C).

6.6. INCORRECT SETTING

This is indicated by gradual lighting/gradual dimming of green LEDs from centre to edges and by the error current of 3.75 mA (IFPF and IFPT).

It is indicated if less or equal flowrate is detected with setting the maximum flowrate than with setting the minimum flowrate.

7. FUNCTION AND STATUS INDICATION

signal	colour	function
<p>"FLOW OUTPUT"</p> 	orange	<p><u>Sensing mode:</u> permanently shine - output is switched dark - output is unswitched</p> <p><u>Setting mode:</u> light with gradual lighting of green LEDs - after holding down on the F pad, the maximum flow rate setting is saved 3 flashes - confirmation of maximum flow rate setting being saved or confirmation of restoring to factory settings light while powering up - when the pen is placed against pad F before it powers up, signals the restore factory settings mode</p>
<p>"BARGRAPH" (5 LED)</p> 	green	<p><u>Start up mode:</u> parallel flashing of all LEDs - indication the sensor temperature is stabilising after powering up</p> <p><u>Sensing mode:</u> gradual lighting up of LEDs from left to right - indication of flow rate based on the flow rate range setting gradual lighting up / turning off from the centre to the edges - incorrect settings *</p> <p><u>Setting mode:</u> one LED is permanently shine - after tapping the pen on the pad F/T indication and movement of the switching point for flow rate / temperature gradual turning off of all LEDs - when the pen is held down on pad T, the minimum flow rate setting is saved gradual lighting up of all LEDs - when the pen is held down</p>
<p>"TEMPERATURE OUTPUT"</p> 	yellow	<p><u>Sensing mode:</u> permanently shine - output is switched dark - output is unswitched</p> <p><u>Setting mode:</u> light with gradual lighting of green LEDs - after holding down on the T pad, the minimum flow rate setting is saved 3 flashes - confirmation of minimum flow rate setting being saved or confirmation change to the switching mode light while powering up - confirmation of minimum flow rate setting being saved or confirmation change to the switching mode</p>

*) It is indicated, when during the setting of the maximum flow rate a lower or equal flow rate is detected than during the setting of the minimum flow rate.

8. ORDER CODE

PRODUCT												
TFS-35												
PERFORMANCE												
N non-explosive areas												
TYPE OF STEM												
10 bare cylindrical												
11 bare cylindrical extended length												
PROCESS CONNECTION												
G½ pipe thread G 1/2												
TYPE OF OUTPUT												
PFPT		1. output – Limit flow rate output (transistor PNP with open collector) 2. output – Limit temperature output (transistor PNP with open collector)										
IFPF		1. output – Limit flow rate output (current 4 .. 20 mA) 2. output – Limit flow rate output (transistor PNP with open collector)										
IFPT		1. output – Limit flow rate output (current 4 .. 20 mA) 2. output – Limit temperature output (transistor PNP with open collector)										
CONNECTION METHOD												
A		stainless steel press-in terminal (+ cable length)										
B		plastic threaded terminal (+ cable length)										
C		connector (socket not included with sensor, recommended type - see accessories)										
V		plastic terminal with a spiral (+ cable length)										
H		plastic terminal for protective hose (+ cable length)										
STEM LENGTH (in mm)												
L20		20 mm, cannot be used for type 11										
L50		50 mm, cannot be used for type 10										
CABLE												
K		cable length in m										
CODE EXAMPLE												
TFS-35	N	-	10	-	G½	-	PFPT	-	A	-	L20	K 2 m

9. CORRECT SPECIFICATION EXAMPLES

TFS-35N-10-G1/2-PFPT-A-L20 cable 2 m

(N) configuration for normal areas; (10) bare cylindrical; (G1/2) process connection with thread G1/2"; (PFPT) PNP type flow rate and temperature sensing terminals; (A) stainless steel cable terminal; (L20) length of stem 20mm; cable 2 m.

TFS-35N-10-G1/2-PFPT-C-L20

(N) configuration for normal areas; (10) bare cylindrical; (G1/2) process connection with thread G1/2"; (PFPT) PNP type flow rate and temperature sensing terminals; (C) M12 connector; (L20) length of stem 20mm.

TFS-35N-10-G1/2-PFPT-B-L20 cable 12 m

(N) configuration for normal areas; (10) bare cylindrical; (G1/2) process connection with thread G1/2"; (PFPT) PNP type flow rate and temperature sensing terminals; (B) plastic cable terminal; (L20) length of stem 20mm; cable 12 m.

10. ACCESSORIES

standard - included in the flow sensor price

- 1 pcs. magnetic pen MP-8

optional – for a surcharge (see catalogue sheet of accessories)

- cable (over the standard 2m length)
- connector socket (type ELWIKa or ELKA)
- standard steel or stainless steel welding flange
- protective hose (for type of cable terminal H)
- stainless steel fixing nut
- various types of seals (PTFE, Al, etc.)

11. SAFETY, PROTECTION AND COMPATIBILITY

The flow sensor TFS-35 is equipped with protection against voltage polarity reversal, protection against current overload and protection against short term overvoltage.

Protection against dangerous contact is provided by low safety voltage according to 33 2000-4-41.

Electromagnetic compatibility is provided by conformity with standards EN 55011 / B, EN 61326-1, EN 61000-4-2 (8 kV), -4-3 (10 V/m), -4-4 (2 kV), -4-5 (1 kV) and -4-6 (10 V).

12. USE, MANIPULATION AND MAINTENANCE

Maintenance of the device consists of regularly checking the integrity of the power cord or the connector and removing dirty material from the rear side of the sensor. If the sensor is set correctly, it does not need to be attended to during operation. In the event of a power outage, all settings are retained. In the event that deposits adhere to the stem of the sensor, it is necessary to remove them regularly.

It is forbidden to make any changes or interventions to the device without the consent of the producer. Any repairs of the sensor must only be carried out by the producer or authorised service organisations.

Assembly, installation, commissioning, operation and maintenance of the device must be performed in accordance with these technical conditions and with the manual. Likewise, provisions of valid norms for the installation of electrical equipment must be adhered to. The operator of the device must be demonstrably acquainted with the operation and maintenance of the device.

Activity during the operation:

- If the sensor is connected to the automatic control system or to emergency signalling, it must not be infringed in its setting during the operation.
- If a change of the sensor settings is necessary, the whole system must be temporarily switched off and the process held in a safe condition using other means and measures.
- Signalling of failure conditions is described in chapter 7. *Status and failure signalization*

Activity in case of a failure:

- In the event of detected faults or fault signals, the whole system must be shut down and the process held in a safe condition using other means and measures.
- If the replacement of the sensor is needed due to the fault, it is necessary to notify the manufacturer (including a description of the fault).

Repairs of the sensors:

If you need to send the sensor for repair, proceed as follows:

- Remove and clean the sensor or perform its decontamination and wrap it well.
- Write a description of the fault as detailed as possible, attach also a detailed description of the application and of the installation location and everything together with the sensor send please to the address of Dinel s.r.o. company.
- Please provide maximum synergy in finding the root cause of the fault. Your satisfaction is our top priority!

13. GENERAL CONDITIONS AND WARRANTY

Dinel, s.r.o. guarantees for the period of three (3) years that the product has the characteristics as mentioned in the technical specification.

Dinel, s.r.o. is liable for defects ascertained within the warranty period and were claimed in writing.

This guarantee does not cover the damages resulting from misuse, improper installation or incorrect maintenance.

This guarantee ceases when the user or the other person makes any changes on the product or the product is mechanically or chemically damaged, or the serial number is not readable.

The warranty certificate must be presented to exercise a claim.

In the case of a rightful complaint, we will replace the product or its defective part. In both cases, the warranty period is extended by the period of repair.

14. MARKING OF LABELS

Labels for device of the type **TFS-35N-__-__-PFPT-__**:

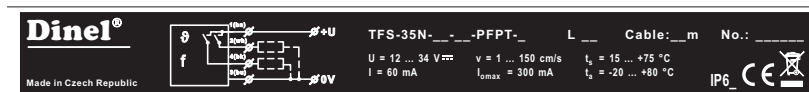

Labels for device of the type **TFS-35N-__-__-IFPT-__**:

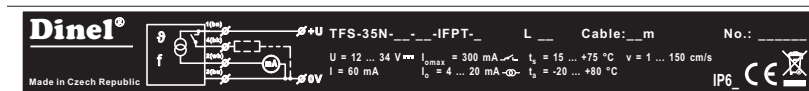

Labels for device of the type **TFS-35N-__-__-IFPF-__**:

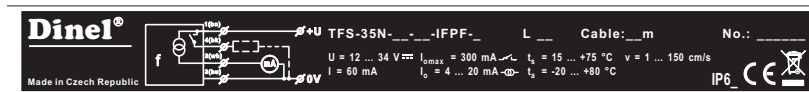

- Symbol of producer: logo Dinel®
- Country of origin: Made in Czech Republic
- Type of flow sensor:
 - TFS-35N-__-__-PFPT-__
 - TFS-35N-__-__-IFPT-__
 - Active current output: $I_o = 4 \dots 20 \text{ mA}$
 - TFS-35N-__-__-IFPF-__
 - Active current output: $I_o = 4 \dots 20 \text{ mA}$
- Connection scheme and labelling of wires: +U, 0 V
- Supply voltage range: U = 12 ... 34 V
- Current consumption: I = 60 mA
- Flow rate range: v = 1 ... 150 cm/s
- Maximum switching current: $I_{\text{omax}} = 300 \text{ mA}$
- Switching temperature range: $t_s = 15 \dots +75 \text{ }^\circ\text{C}$
- Ambient temperature range: $t_a = -20 \dots +80 \text{ }^\circ\text{C}$
- Length of the sensor: L __
- Cable length: Cable: __ m
- Product serial number: No.: ____ - (from left: year of manufacture, serial number)
- Protection class: IP6_ (Protection class according to electrical connection)
- Compliance mark: CE
- Electro-waste take-back system mark:



Size of labels 112 x 12 mm, the size shown does not correspond to reality.

15. TECHNICAL SPECIFICATIONS

BASIC TECHNICAL DATA	
Working area (EN 60079-10-1)	no explosive hazard area
Supply voltage	12 ... 34 V DC
Current consumption	TFS-35N-_-_-PFPT-_ 60mA for supply voltage U = 24V DC 70mA for supply voltage U = 18V DC 80mA for supply voltage U = 15V DC 100mA for supply voltage U = 12V DC
	TFS-35N-_-_-IFPT-_ TFS-35N-_-_-IFPF-_ 60mA for supply voltage U = 24V DC + current loop 70mA for supply voltage U = 18V DC + current loop 80mA for supply voltage U = 15V DC + current loop 100mA for supply voltage U = 12V DC +current loop
Output	TFS-35N-_-_-PFPT-_ 2 x transistor PNP with open collector (Switching current - max. 300 mA, Residual voltage-ON state - max.1,5V)
	TFS-35N-_-_-IFPT-_ TFS-35N-_-_-IFPF-_ 1 x transistor PNP with open collector (Switching current - max. 300 mA, Residual voltage-ON state - max.1,5V) 1 x active current output 4 .. 20 mA.
Maximal resistance of current output load	800 Ω for supply voltage U = 24V DC 500 Ω for supply voltage U = 18V DC 200 Ω for supply voltage U = 12V DC
Indication of incorrect settings	3,75 mA at current output + indication of bargraph ⁽¹⁾
Maximum switching current	300 mA
Maximum residual voltage in ON state	1,5 V
Temperature output - switching points	15 °C; 30 °C; 45 °C; 60 °C; 75 °C
Flow rate range	1 to 150 cm/s (for water)
Temperature gradient	< 250 K/min
Isolating capacity (housing - inputs) / electrical strength	4 nF / 350 V AC
Ambient temperature range t_p	-20 °C až +85 °C
Protection	IP67 (variant C) IP68 (variant A, B, V, H)
Ambient working temperature range (t_a)	-20 ... +80 °C
Cable	PVC 4x0,5 mm ²
Heat up time after start	10s
Response time	2 to 15s ⁽²⁾
Pressure strength	10 MPa (100 bar) over full temperature range
Weight of sensor (without cable)	150g

*1) See chapter 7. Function and status indication

*2) Depending on the flow rate and setting of the sensor.

USED MATERIALS

part of the sensor	type	standard material
Housing (including measur. stem)	all	stainless steel W.Nr. 1.4404 (AISI 316L)
End of sensor	all	stainless steel W.Nr. 1.4301 (AISI 304)
Cable terminal	TFS-35 _ _ _ _ _ A- L _ _	stainless steel W.Nr. 1.4571 / NBR
	TFS-35 _ _ _ _ _ B- L _ _	plastic PA / NBR
	TFS-35 _ _ _ _ _ V- L _ _	plastic PA / NBR
	TFS-35 _ _ _ _ _ H- L _ _	plastic PA / NBR
Connector M12	TFS-35 _ _ _ _ _ C- L _ _	nickel-plated brass

PROCESS CONNECTION

name	dimensions	marking
pipe thread	G 1/2"	G 1/2

DEFAULT SETTINGS TABLE (FACTORY DEFAULT)

Output mode	switching (O)
Flow rate sensing range	0 .. 100 cm/s ^{*2)}
Flow rate switching point (PFPT, IFPF)	3. LED
Temperature switching point (PFPT, IFPT)	3. LED

*2) The medium for the default flow rate sensing settings was water.

16. PACKING, SHIPPING AND STORAGE

The device TFS-35 is packaged in a polyethylene bag, and the entire consignment is placed into a cardboard box. A suitable filler material is used in the cardboard box to prevent mechanical damage during transport. Remove the device from the packaging only just before using, thereby protecting it from potential damage.

A forwarding company will be used to ship goods to the customer. Upon prior agreement, ordered goods can be picked up in person at company headquarters. When receiving, please check to see that the consignment is complete and matches the order, or to see if any damage has occurred to the packaging and device during transport. Do not use a device clearly damaged during transport, but rather contact the manufacturer in order to resolve the situation.

If the device is to be further shipped, it must be wrapped in its original packaging and protected against impact and weather conditions.

Store the device in its original packaging in dry areas covered from weather conditions, with humidity of up to 85 % without effects of chemically active substances. The storage temperature range is -10 °C to +50 °C.