

INSTRUCTION MANUAL



CAPACITIVE LEVEL METER CLM-70

CONTENTS

1. Safety	4
2. Basic description	4
3. Range of application	5
4. Variants of sensors	5
5. Dimensional drawings	6
6. Installation and putting into operation	8
7. Installation instructions	8
8. Electrical connection	13
9. Setting elements	14
10. Setting the level meter	15
10.1. Basic settings.....	15
10.2. Service settings.....	18
10.3. Additional functions.....	19
11. HART® protocol	21
12. How to install a custom measuring electrode, replace or shorten the electrode	22
13. Order code	24
14. Failure status indication	24
15. Accessories	25
16. Safety, protection, compatibility and explosion proof	25
17. Use, manipulation, and maintenance	25
18. Marking of labels	26
19. Menu structure	27
20. Technical specifications	28
21. Error codes	31
22. Packing, shipping and storage	31

USED SYMBOLS

To ensure maximum safety of control processes, we have defined the following safety instructions and information. Each instruction is labelled with the appropriate pictogram.



Alert, warning, danger

This symbol informs you about particularly important instructions for installation and operation of equipment or dangerous situations that may occur during the installation and operation. Not observing these instructions may cause disturbance, damage or destruction of equipment or may cause injury.



Information

This symbol indicates particularly important characteristics of the device.



Note

This symbol indicates helpful additional information.

1. SAFETY



All operations described in this instruction manual have to be carried out by trained personnel or by an accredited person only. Warranty and post warranty service must be exclusively carried out by the manufacturer.

Improper use, installation or set-up of the sensor can lead to crashes in the application.

The manufacturer is not responsible for improper use, loss of work caused by either direct or indirect damage, and for expenses incurred at the time of installation or during the period of use of the level sensors.

2. BASIC DESCRIPTION

Capacitive level meters CLM-70 are compact measuring devices consisting of the level meter body and a measuring electrode. The level meter body contains measurement electronics and a display module. The electronics measure the electrical capacity of the electrode system, which is dependent on the level height. The level meter's electrical output corresponds to the capacity (level height) and the measured data are shown on the meter's display.

The level meter can be adjusted by the display module positioned under the transparent lid. The level meter has 4–20 mA current output with HART® communication. The level meter is power supplied using a cable connected to the terminal block located under the display and adjustment module.

Level meters are available in several measuring electrode modifications (rod and rope-type electrodes). Electrodes may be coated with insulation, which is important for their functioning in the case of adherent, electrically conductive and aggressive media. Rod electrodes are also available in a version provided with a reference tube or a pair of parallel electrodes for measuring liquids in non-conductive tanks.

3. RANGE OF APPLICATION

The capacitive level meters are suitable for continuous level measurement of various liquids and solid materials. The level meters are resistant to any changes in the atmosphere above the level (vacuum, overpressure, steam, or dust).

4. VARIANTS OF SENSORS

- **CLM-70_00** **Without electrode**; customer makes an electrode himself (types 10 or 30 only) and attaches it to the electrode holder using M8 threaded connection.
- **CLM-70_10** **Uncoated stainless steel rod electrode** for level measurement of electrically non-conductive liquids (oils, diesel fuel) and bulk solids (flour, sand, cement, granulated plastic materials, etc.). Length 0.2 ... 8 m.
- **CLM-70_11** **Coated stainless steel rod electrode (PFA)** with enhanced resistance to penetration (diffusion) of vapours and gases. For level measurement of water and other electrically conductive liquids in food processing, pharmaceutical, and chemical industries. It can be used temporarily for high-temperature applications (e.g. sanitization with hot steam) or for volatile aggressive liquids, etc. Length 0.2 ... 3 m.
- **CLM-70_12** **Coated stainless steel rod electrode (FEP)**, suitable for level measurement of water and other electrically conductive liquids. Also suitable for impure liquids in metallic tanks, concrete sumps, etc. Length 0.2 ... 3 m.
- **CLM-70_13** **Semi-coated stainless steel rod electrode (FEP)** for level measurement of electrically non-conductive liquids in environments where partial condensation of vapours on the electrode may occur. Length 0.5 ... 8 m.
- **CLM-70_20** **Uncoated stainless steel rod electrode** with reference tube for level measurement of unpolluted and electrically non-conductive liquids (oil, diesel fuel, petrol). Length 0.2–3 m.
- **CLM-70_22** **Coated stainless steel rod electrode (FEP)** with reference tube for level measurement of clean electrically conductive liquids (e.g. in plastic and glass tanks) and for higher measuring accuracy. Length 0.2 ... 3 m.
- **CLM-70_30** **Uncoated stainless steel rope electrode and weight** for level measurement of bulk solids and powders (sand, flour, cement, etc.). The rope can also be shortened. Length 1 ... 20 m.
- **CLM-70_31** **Uncoated stainless steel rope electrode and coated dynamic anchor** for measurement of bulk solids in taller silos. Length 1 ... 20 m.
- **CLM-70_32** **Fully coated stainless steel rope electrode and weight (FEP rope insulation, PTFE weight insulation)**, designed for level measurement of water and other electrically conductive liquids. Length 1 ... 12 m.
- **CLM-70_61** **Two coated stainless steel rod electrodes (PFA electrode insulation, PTFE head)** for level measurement of aggressive liquids. Length 0.2 ... 2 m.

5. DIMENSIONAL DRAWINGS

CLM-70_00

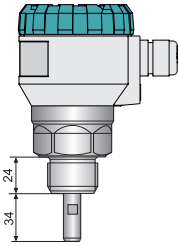

CLM-70_10

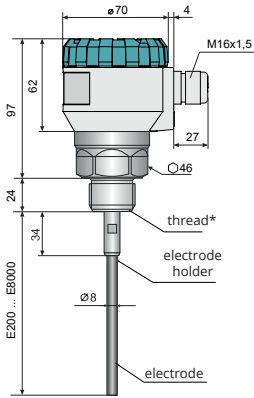

CLM-70_11, 12

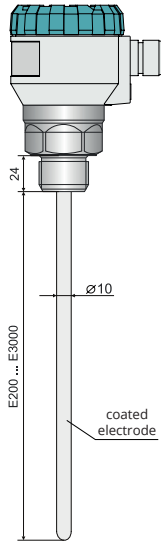

CLM-70_13

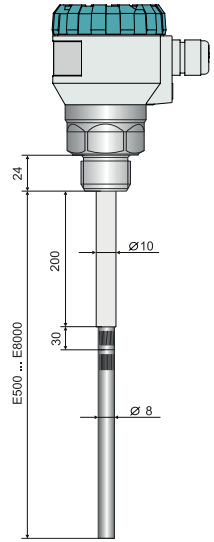

CLM-70_61

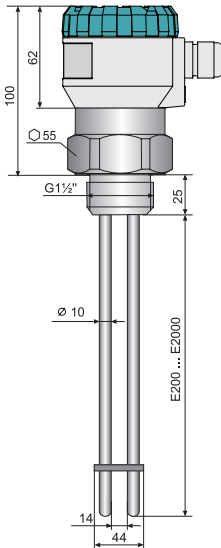

High temperature performance
CLM-70_T**

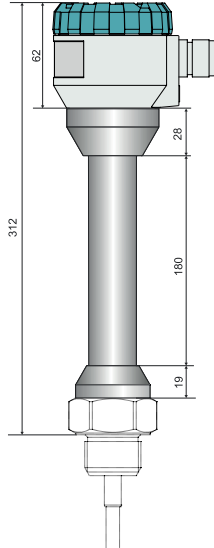

Process connection
Tri-clamp***

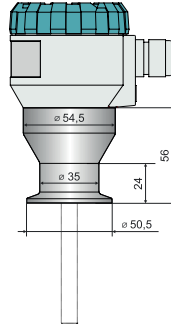

Variant CLM-70
with a cable gland
for protective hose

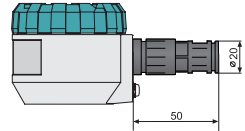

* types of thread: G1" (except type 61),
1" NPT (except type 61)

** Except type CLM-70_61

*** Only for type CLM-70_11(12, 13, 32)

CLM-70_20, 22

CLM-70_31

CLM-70_30

CLM-70_32

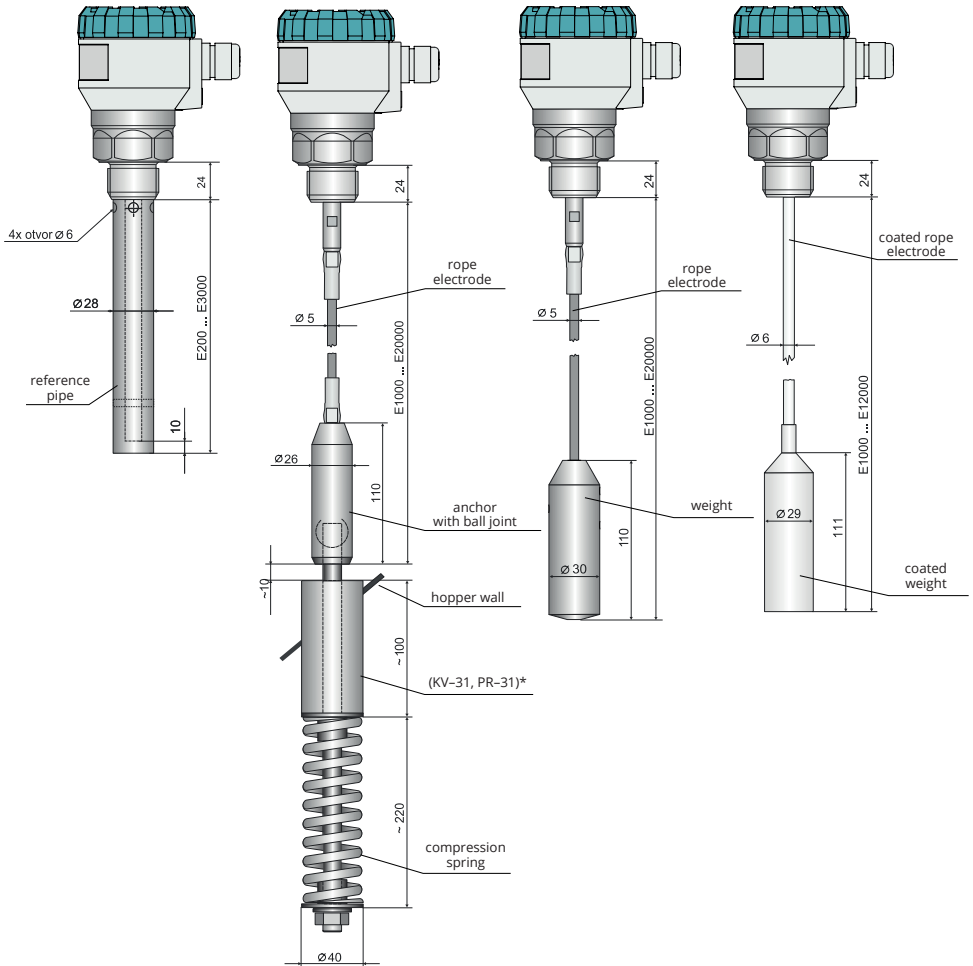

* anchor roll KV-31 or dust proof bushing PR-31 (see accessories)

6. INSTALLATION AND PUTTING INTO OPERATION

This procedure has the following three steps:

- **INSTALLATION INSTRUCTIONS**
- **ELECTRICAL CONNECTION**
- **SETTINGS**

7. INSTALLATION INSTRUCTIONS

BASIC INFO

- The level meters with an insulated electrode are equipped with a protective cap at the electrode end, which must be removed before installation.
- The level meters are mounted vertically into the upper lid of the tank or hopper or on fixing brackets using a welding flange for a fixing nut or a Clamp-type flange.
- When installing the level meter in a metal tank or hopper, the housing is not necessary to be grounded separately.
- In the case of installation in concrete sumps or silos, the level meter is advisable to be installed on an auxiliary metal structure (bracket, lid, etc.) and then connected to a permanently submerged metal object or steel reinforcements in concrete (armouring).

METAL AND NON-METAL VESSELS

APPLIES TO: CLM-70_-10, 11, 12, 13

Auxiliary electrode width = minimum 30 mm (required for non-metal vessels only)

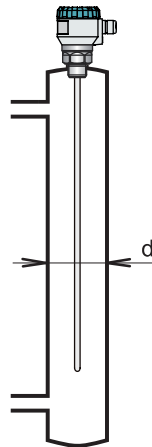
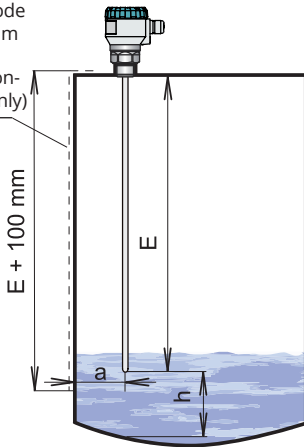

- E - electrode length [mm] – select so that the electrode end is submerged at least 20 mm below the lowest measured level
- h - distance from the bottom – at least 50 mm
- a - distance from the wall – at least approx. E/20
- d - diameter of the auxiliary tubular vessel – at least 40 + E/20 (smaller dimensions must be discussed)

Fig. 1: Installation of level meters with rod electrodes

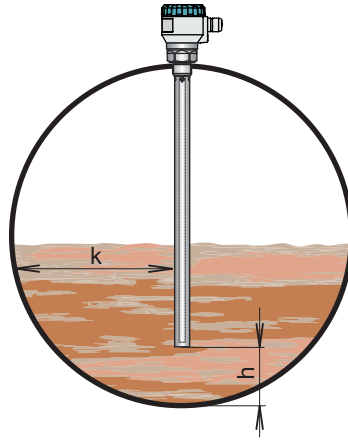

h - distance from the bottom – at least 50 mm due to the possible presence of heavier fractions (water) in petroleum products
k - distance from the wall – arbitrary

Fig. 2: Installation of the level meter with a reference tube

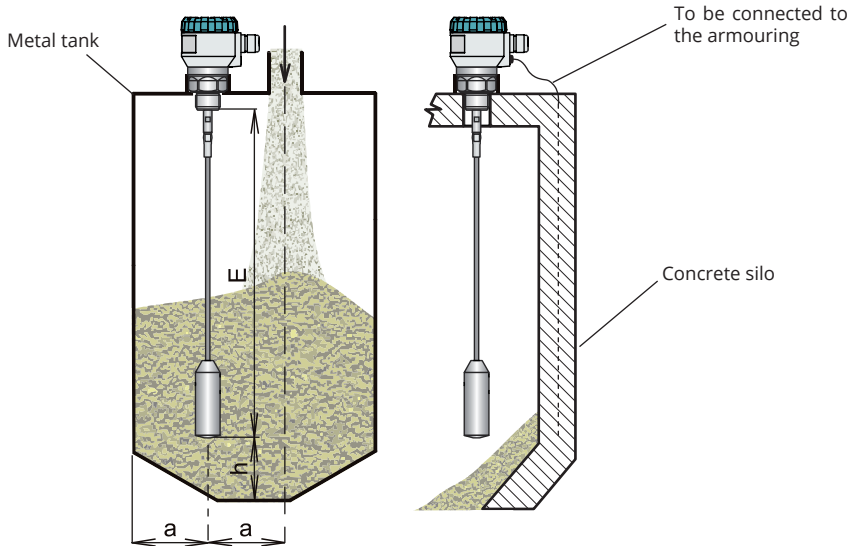

E - electrode length [mm] – to be selected so that the electrode end is placed at least 20 mm below the lowest measured level

h - distance from the bottom – at least 100 mm

a - distance from the wall – at least $E/20$; otherwise, choose as large as possible (as far from the wall as possible) in the middle between the wall and the vertical drain

Fig. 3: Installation of level meters with rope electrodes

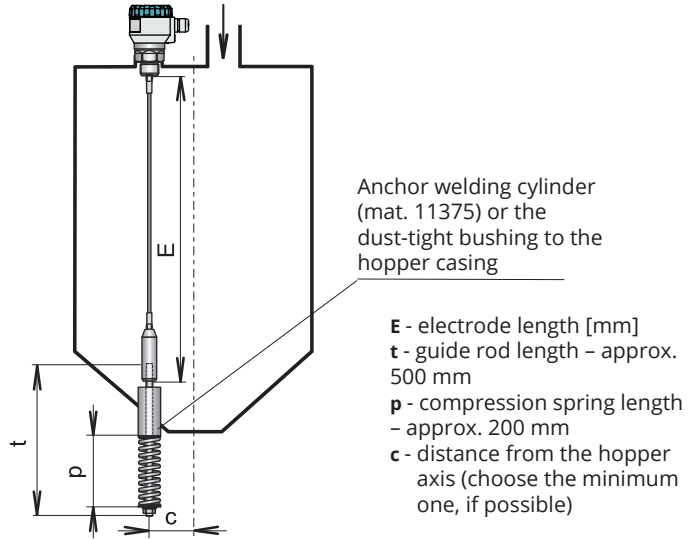
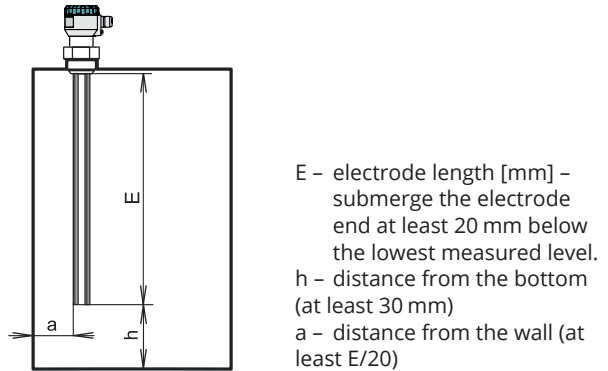
ROPE ELECTRODE WITH AN ANCHOR**APPLIES TO: CLM-70_-31***Fig. 4: Installation of the level meter with a rope electrode and anchor***AGGRESSIVE LIQUIDS, NON-METAL VESSELS****APPLIES TO: CLM-70N-61***Fig. 5: Installation of the level meter with a reference electrode*

TANK WITH INSULATION

APPLIES TO: CLM-70NT-

- The level meters for high operating temperatures are equipped with an extension. This is used to thermally insulate the electronics part of the meter from the high operating temperature. The extension must not be embedded in the insulation more than 50 mm.

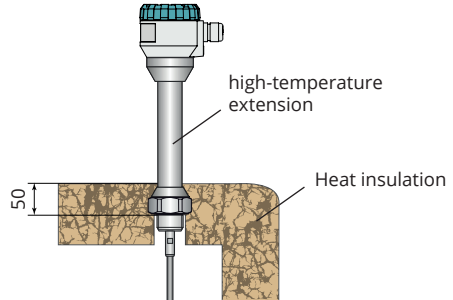

Fig. 6: Installation of the level meter in an insulated tank

COVERING THE LEVEL METER

APPLIES TO: All types

- The level meter must not be installed in places exposed to direct **sunlight** and must be protected from the weather influences. Even so installation is in exposed places to direct sunlight a **shielding cover** is necessary to be fitted over the level meter (see Fig. 7).

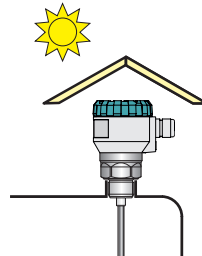

Fig. 7: A shielding cover protecting against direct sunlight

OUT OF REACH OF FILLING

APPLIES TO: All types

- The level meter is not recommended to be installed at or above the **filling** point. Measurement may be influenced by the inflow medium.

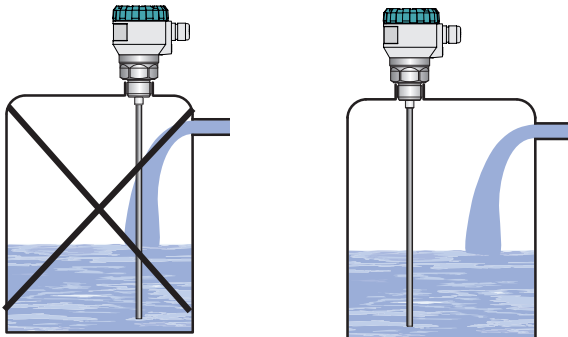

Fig. 8: Installation of the level meter out of the reach of filling flow

MOISTURE

APPLIES TO: All types

- It is advisable to run the cable under a cable gland (sagging downwards). This prevents possible **ingress of moisture through the cable gland**. Rain and condensing water can flow freely downwards, see Fig. 9.
- The cable gland and the top lid must be **sufficiently tightened** to prevent moisture ingress.

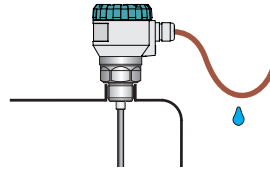

Fig. 9: Preventing moisture from ingress through the cable gland

VARIANT WITHOUT AN ELECTRODE

APPLIES TO: CLM-70_-00

- The level meter of the CLM-70_-00 type is provided without a measuring electrode. Therefore, the measuring electrode is necessary to be made and mounted to the level meter body. The electrode diameter must be between 8–10 mm. For connection, the electrode must have an M8 male thread. For the connection procedure, see chapter 12, p. 22.

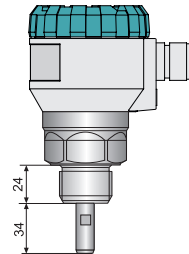

Fig. 10: The level meter without an electrode



For the level meter of the CLM-70_-00 type, the manufacturer is not responsible for defects related to the connected measuring electrode!



It is intended for non-conductive media only, as only a non-insulated rod or rope can be connected.

8. ELECTRICAL CONNECTION

The level meter is connected to the follow-up (evaluation) device using a suitable cable with an outer diameter of 6–8 mm by means of screw terminals located under the display module. The recommended wire cross-section is $2 \times 0.5\text{--}0.75\text{ mm}^2$ (shielded) for the current version. The positive pole (+U) is connected to the (+) terminal, the negative pole (0 V) to the (-) terminal, and the shield (only for shielded cables) is connected to the () terminal.

To connect a cable to the level meter:

1. Unscrew the upper lid nut.
2. Grasp the top edge of the display module and carefully slide it upwards carefully by slightly swinging it.
3. If you are unable to grasp the display module, a small screwdriver can be used – insert it under the edge and slightly lift the module from several sides.
4. Loosen the cable gland to pass a stripped power cable inside.
5. Connect the cable to threaded terminals, as shown in the diagram in Fig. 11. Tighten the terminals and cable gland firmly. For the tightening torque, see the Technical Specifications.
6. Return the display module into the head until the connector is connected correctly.
7. Slide the silicone seal onto the level meter body thread and tighten the upper lid nut firmly. Connect the cable to the downstream device.

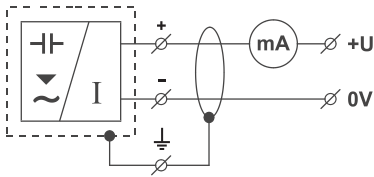

Fig. 11: Connection diagram of level meter with current output CLM-70_--I

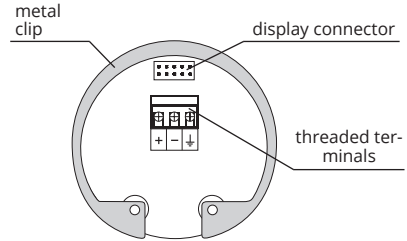

Fig. 12: Internal view of threaded terminals of level meter with current output CLM-70_--I



Electrical connection can only be made in a voltage-free state!

The power supply must be designed as a stabilized source of low safe voltage with galvanic isolation. If a switched power supply is used, its design must effectively suppress common mode interference. If the switched power supply is equipped with a PE protective terminal, it must be earthed without fail!

If the sensor is to be installed in an outdoor environment more than 20 m from an outdoor switchboard or an enclosed building, the electrical supply to the sensor must be supplemented with suitable overvoltage protection.

In case of a strong environmental electromagnetic interference, common routing of the signal cable with the power cable or in case of more than 30 m in length, we recommend grounding the level meter and using a shielded cable. Ground the cable shielding on the side of power supply or connect it to the internal connection terminal of the level meter marked as \perp , see Figs. 22 and 23 (the cable shielding should always be connected in one point).

9. SETTING ELEMENTS

Setting is done using the 3 buttons located on the DM-70 display module. All setting items are available in the level meter menu.

Button

- access to the setting menu
- acknowledgement of the selected menu item
- cursor movement in line
- saving settings

Button

- navigation in menu
- changing values

Button

- cancelling changes
- moving up a level

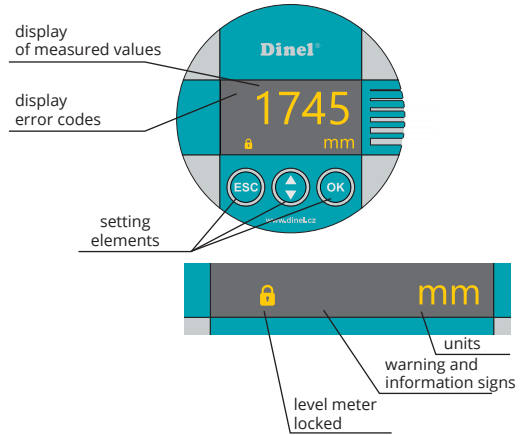

* flashes intermittently when receiving a reflected signal (echo) from the measured level

- **Status indication (lower left corner of the display):**
 - symbol ** - **lights permanently** - the level meter is locked against unauthorized settings; a password is required for unlocking (see MENU – PASSWORD)
- **Warning signs:**
 - FIXED OUTPUT** - the output current is fixed to a constant value (see MENU – DIAGNOSTIC – CURRENT)
 - LOW POWER** - low supply voltage (it must be within the specified range – see TECHNICAL SPECIFICATIONS)
 - NO PASSWORD** - when changing the locked level meter settings
 - NO DATA AVAILABLE** - display module doesn't communicate with the electronics of the level meter (e.g. incorrectly inserted display module into connector or measuring module is not functional).
- **Information signs:**
 - CAPACITY** - actual capacity displayed (see DIAGNOSTIC – CAPACITY)
 - CURRENT** - actual current displayed (see DIAGNOSTIC – CURRENT)
- **Error codes:**
(see chapter 21. Error Codes)



The level meter, type CLM-70_ _ _ _ _L, is supplied without the DM-70 display module. To set up the level meter it is necessary to connect a display module (or it can be configured via HART). When the set-up is complete, the display module can be disconnected and the level meter takes measurements without it.

10. SETTING THE LEVEL METER

The level meter is controlled by **3 buttons** located on the removable DM-70 display module (see the Control Units chapter, p. 14).

Saving of values is indicated by the word “*SAVED*” at the display bottom (see Fig.). Values that have not been confirmed with the  button **will not be saved!** After inactivity lasting 5 minutes, the level meter automatically goes back to the measuring mode. If the password is active, the level meter locks besides. **No** changes in settings are possible to be made after locking! When attempting to edit, “NO PASSWORD” appears on the display. How to unlock, see p. 20.

After connecting the supply voltage, the manufacturer's logo and the text “*Starting*” appear on the level meter display. Then, the level meter goes into the measuring mode, and the actually measured value is displayed.



10.1. BASIC SETTINGS

After the first start of the level meter, the basic configuration (setting of the measuring range, selecting units and possible damping) must be performed. The settings are accessible in the basic menu by pressing the  button under “BASIC SETTINGS”.

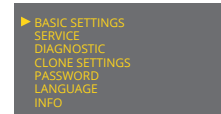

MIN CAPACITY (MAX CAPACITY)

Here, the CAPACITY range (in the **CAPACITY** line), within which the level meter should measure, must be set. The output current range (the **OUTPUT** line) of 4 mA/20 mA output is then assigned to this range. And the value shown on the meter display (**DISPLAY** line).

In the upper right corner below the sign “**ACTUAL CAPACITY**”, the value of the currently measured level is displayed.

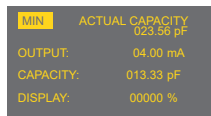

ACTUAL CAPACITY: current measured capacity

CAPACITY: definition of the min/max capacity

DISPLAY: the value show on the display

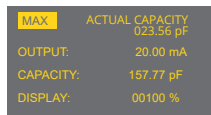

UNITS

The CAPACITY line – the units, in which the measuring and adjustment of the level meter (pF) takes place

The DISPLAY line – the setting of the units to be displayed on the main display screen (%; pF; mm; cm; m; in; ft; l; hl; m³; gal; bbl; and mA).



CAPACITY: only units pF

DISPLAY: the unit shown on the display (%; mm, cm, m, in, ft, l, hl, m³, gal, bbl, and mA)

1. Press the **OK** button to enter the menu; use the same button to select “BASIC SETTINGS”. Then, use the **↓** and **OK** buttons to select “UNITS”.
2. Now, the “UNITS” item is displayed. Use the **OK** and **↓** buttons to set each item.
3. After finishing the settings, press the **OK** button to save the data. Press the **ESC** button successively to exit the menu; the level meter returns to the measuring mode.

DAMPING

The time constant of the output variable filter is set here. The time constant is given in seconds. The response progress of the output variable to a step change of the level is exponential. The time constant indicates the time, within which the output value reaches approximately 63% of the maximum value.

Higher values are useful for suppressing display fluctuations during rapid changes (whirling level). Conversely, if a rapid response is required, a low damping value must be set.

The damping time can be set within the interval of 0 to 99 seconds.

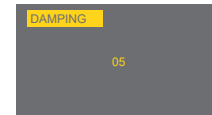

The damping time can be set within the interval of 0 to 99 seconds.

1. Press the **OK** button to enter the menu; use the same button to select “BASIC SETTINGS”. Then, use the **↓** and **OK** buttons to select “DAMPING”.
2. Now, the “DAMPING” item is displayed. Use the **OK** and **↓** buttons to set damping.
3. After finishing the settings, press the **OK** button to save the data. Press the **ESC** button successively to exit the menu; the level meter returns to the measuring mode.

SETTING PROCEDURE FOR THE LEVEL METER

The level meter must be installed properly in the tank and connected to the power supply. Then, the basic level meter settings can be made.

A) THE SETTING METHOD AT LIMIT POINTS OF RANGE (if the tank is possible to be completely emptied and flooded with a medium) – this method is preferred

1. Bring the measured medium to the minimum capacity. In the **BASIC SETTINGS - MIN CAPACITY** menu, the value of electrical capacity measured by the level meter in real time is displayed in the upper right corner under the sign "ACTUAL CAPACITY". This value must be copied to the **CAPACITY** line. The value which is shown on the display at this minimum capacity is entered in the **DISPLAY** line. The **OUTPUT** line is not editable and displays the value of an output variable at the minimum capacity.
2. Bring the measured medium to the maximum capacity. In the **BASIC SETTINGS - MAX CAPACITY** menu, the value of electrical capacity measured by the level meter in the real time is displayed in the upper right corner under the sign "ACTUAL CAPACITY". This value must be copied to the **CAPACITY** line. The value which is shown on the display at this maximum capacity is entered in the **DISPLAY** line. The **OUTPUT** line is not editable and displays the value of an output variable at the maximum capacity. The conversion to the shown value on the display and the output (current) is always linear depending on the capacity to be measured.
3. In the **BASIC SETTINGS - UNITS** menu, the required units for display on the main screen of the meter display are set in the **DISPLAY** line. The **CAPACITY** line is not editable and indicates in which units the level meter measures the capacity.
4. The time constant of the output variable filter is set in the **BASIC SETTING - DAMPING** menu.

B) THE SETTING METHOD AT ANY POINT WITHIN THE RANGE (if the tank cannot be completely emptied or flooded with a medium)

1. Flood the tank to a known level H_1 (e.g. 15%). In the **SERVICE - CAPACITY** menu item, the capacity at this known flooding (15%) can be found. This capacity is noted down and denoted as C_1 (e.g. 35 pF).
2. Flood the tank to another known level H_2 (e.g. 78%). In the **SERVICE - CAPACITY** menu item, the capacity at this known flooding (78%) can be found. This capacity is noted down and denoted as C_2 (e.g. 126 pF).
3. The capacities at the limit points of the measuring range can be calculated using the following formulas.

For capacity at the lower limit point of the measuring range:

$$C_{\text{MIN}} = C_1 - H_1 \cdot (C_2 - C_1) / (H_2 - H_1)$$

Example: $C_{\text{MIN}} = 35 - 15 \cdot (126 - 35) / (78 - 15) = 13.33 \text{ pF}$

For capacity at the upper limit point of the measuring range:

$$C_{\text{MAX}} = C_{\text{MIN}} + 100 \cdot (C_2 - C_1) / (H_2 - H_1)$$

Example: $C_{\text{MAX}} = 13.33 + 100 \cdot (126 - 35) / (78 - 15) = 157.77 \text{ pF}$

4. The calculated value of C_{MIN} is to be entered into the meter's **BASIC SETTINGS - MINIMUM CAPACITY** menu **in the CAPACITY line**. The value to be displayed at the minimum capacity is entered in the **DISPLAY** line. The **OUTPUT** line is not editable and displays the value of an output variable at **the minimum capacity**.
5. The calculated value of C_{MAX} is to be entered into the meter's **BASIC SETTINGS - MAXIMUM CAPACITY** menu **in the CAPACITY line**. The value to be displayed at the maximum level is entered in the **DISPLAY** line. The **OUTPUT** line is not editable and displays the value of an output variable at the maximum capacity. The conversion to the display value and the output quantity (current) is always linear depending on the capacity to be measured.
6. In the **BASIC SETTINGS - UNITS** menu, the required units for display on the main screen of the meter display are set in the **DISPLAY** line. The **CAPACITY** line is not editable and indicates in which units the level meter measures the capacity.
7. The time constant of the output variable filter is set in the **BASIC SETTING - DAMPING** menu.

10.2. SERVICE SETTINGS

In the service settings, the failure state behaviour or HART® communication can be configured. It is also possible to set the sensor into its default settings or reset it. The settings are accessible in the basic menu under “SERVICE”.

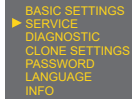

BASIC SETTINGS
▶ SERVICE
DIAGNOSTIC
CLONE SETTINGS
PASSWORD
LANGUAGE
INFO

FAILURE MODE

It determines the current value at the level meter output if the self-diagnostics of the level meter detects an internal fault. It is possible to set the following currents: 3.75 mA; 4 mA; 20 mA; 22 mA; LAST VALUE



The failure mode is displayed on the main screen. For the error code description, see chapter 21.

HART®

This item is a part of the menu of the level meter with a current output, CLM-70_--_-. Settings of the HART® protocol (point to point, multidrop) and multidrop mode address. In the multidrop mode, up to 15 devices can be connected to one 2-wire cable.



For address “00”, point to point mode is activated. The range from “01” to “15” is reserved for multidrop mode addresses (current is fixed at 4 mA).

FACTORY DEFAULT

Loading the **factory default values**. The loading is performed by pressing the  button. The table of the default settings is shown on p. 29.



After pressing the  button, “RUNNING” appears for a short time. After loading the default values, the display shows “DONE” and the message: “Press Esc to exit”.

RESET

This option performs a **complete restart of the** level meter. A short-term interruption of the supply voltage has the same effect. Reset is activated by the  button.



During the restart, the display shows “RUNNING”. Then, the level meter switches off automatically and restarts.

10.3. ADDITIONAL FUNCTIONS

Additional functions include modes for copying settings or detecting the actual loop current. Further, they include password-based locking of modification and the level meter (display module) version information. All these functions are accessible from the main menu.

DIAGNOSTIC

CAPACITY: Displays the actual value of the capacity that the sensor is currently measuring.



CURRENT: Displays the actual value of the output current flowing through the loop



ON DISPLAY:

YES – Diagnostics value (CAPACITY or CURRENT) is displayed on the main screen.

NO – The standard measured value as set in the BASIC SETTINGS, MIN/MAX – DISPLAY is displayed on the main screen.

SET VALUE: Set the current to a fixed value (3.75 mA – 4mA – 12mA – 20mA – 22mA – MEASUR.). If the MEASUR. option is selected, the current corresponds to the measured value.



The SET VALUE option can be used to diagnose the connected evaluation device. If the current is set to a fixed value, "FIXED OUTPUT" is displayed on the main display, and the text "FIXED" is displayed in the SET VALUE section.

CLONE SETTINGS

This mode is for **copying the CLM-70 level meter (body) configuration** to the DM-70 display module (display) and vice versa. Then, the display module can be removed from the level meter body, and its settings can be transferred to the other level meter body.

The "CLONE SETTINGS" mode transfers all data except the "TEACHING" mode settings and the HART® protocol configuration.



1. Press the **OK** button to enter the menu; select "CLONE SETTINGS". To copy the settings from the level meter body to the display module, select "SENSOR → DISPLAY MODULE". To transfer the settings from the display module to another level meter, select "DISPLAY MODULE → SENSOR".
2. Press the **OK** button to run the selected mode, "NOW CLONING" appears on the display during transfer.
3. When the process is complete, "DONE" appears in the display centre. Then, it is possible to press the **ESC** button again and exit the mode as well as the menu.

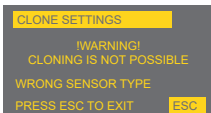

Incompatible electrode type and length. Settings can only be transferred for the level meters of the **same type and with the same electrode length.**

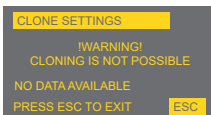

The **setting data is not saved** in the DM-70 display module. The transfer cannot be performed. It is necessary to repeat the procedure of copying the settings in the "CLONE SETTINGS" mode from the sensor to the display.

PASSWORD

Here, the level meter can be locked to prevent unauthorised data editing. Once the password is activated, the data can be read, but cannot be edited. When attempting to edit, the "NO PASSWORD" message appears on display.

The password can have any five-digit combination. The combination of 00000 is reserved for **the password deactivation.**

1. Use the and buttons in the "PASSWORD" menu to select the mode for entering the password – "ENTER" – or changing the password – "CHANGE" – (when activated, both messages are displayed inversely). Press the button again to confirm the selection. The password can only be changed when the level meter is unlocked. Otherwise, "NO PASSWORD" appears.
2. Now, you can enter (edit) the password. The actual item for editing is displayed inversely. Press the button to move to the next position (direction from left to right); the button is used to change the values (0 ... 9).
3. The data is saved using the button.

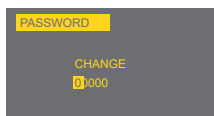
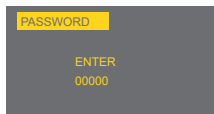
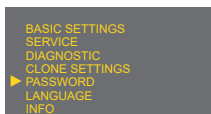

Displaying the status after confirming the data:

- "YES" – correct password entered*
- "NO" – wrong password entered*
- "OK" – save the password (only for "CHANGE")*

The password is automatically hidden after entering or changing (displayed as "00000"). Enter the number combination of "00000" in the "CHANGE" mode to deactivate the password.



If you lose your password, contact the manufacturer.



The level meter with the password activated is locked automatically after five minutes of inactivity or five minutes after switching to the measuring mode. Locking the level meter is indicated by a padlock symbol () in the left bottom corner of the display.

LANGUAGE

The setting of the display menu language.

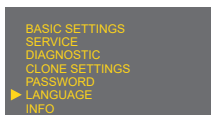

There are three language options to choose from:

ČESKY – ENGLISH – по русски

INFO

Here, information about the level meter and the display module (type, serial number – SN, and firmware version – SW) can be found.

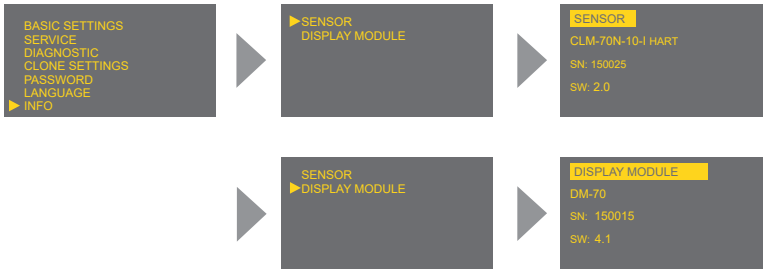

11. HART® PROTOCOL

A universal communication interface for the communication of peripheral devices with the level meter. Data communication runs in the same line as the analogue signal 4 ... 20 mA without disturbing its function.

To set the level meter and collect measured data, the HART® communicator, which can communicate directly with the level meter or which can be used to communicate with the peripheral device, must be available, see Fig. 13.

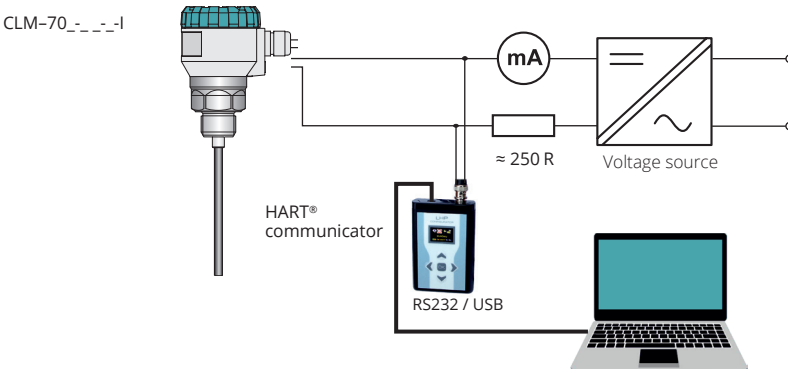

Fig. 13: Connection of peripheral devices with the HART® protocol

HART® specifications

The implemented HART® protocol is of revision No. 5.

It contains universal commands: 0, 1, 2, 3, 6, 11, 12, 13, 14, 15, 16, 17, 18, and 19; and standard (practical) commands: 34, 35, 40, 42, 44, and 49.

Meaning of variables

PV - measured capacity

SV - value shown on display

TV - not used

FV - capacity corresponds to the level



For more information contact the manufacturer.

12. HOW TO INSTALL A CUSTOM MEASURING ELECTRODE, REPLACE OR SHORTEN THE ELECTRODE

The installation procedure of custom measuring electrode – applies to type 00

1. Make the custom electrode according to the drawing (see Fig. 14). The length of this electrode must be by 7 mm shorter than the dimension "E" in Fig. 30. Stainless steel of the 1.4404 (AISI 316 L) type or similar, depending on the application, is recommended as the measuring electrode material.
2. Apply glue on the thread of the prepared electrode made according to the drawing (see Fig. 31) to secure the threaded joints (the amount of glue is provided by the manufacturer). The glue used must meet specific criteria depending on the application, e.g. it must resist high temperatures, corrosion, chemicals, or must be approved, e.g. for use in the food industry.
3. Screw the electrode tightly into the electrode holder using appropriate pliers or a wrench (on the electrode side) and a 10-mm flat spanner (on the electrode holder side).
4. Let the glued joint cure as recommended by the glue manufacturer; after then, the level meter is ready for installation.
5. Perform the setting of the level meter.

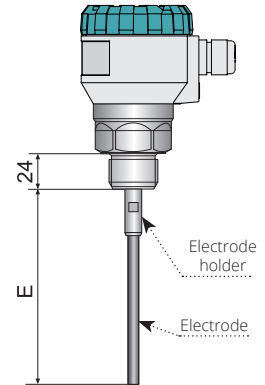

Fig. 14: Drawing of the level meter with dimension "E"

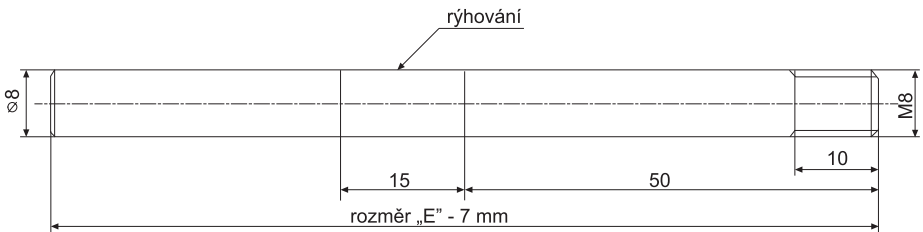
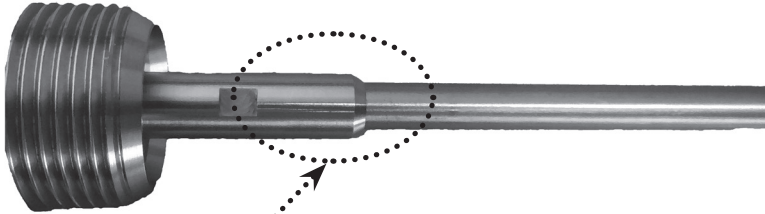

Fig. 15: Drawing of the measuring electrode with marked thread for connection and grooving

How to replace the measuring electrode – applies only to variants 10, 30, and 31

1. Heat the place of the threaded joint of the electrode and the electrode holder (see Figs. 15 and 17) using a heat gun to a temperature of approx. 120–150 °C (or 220–250 °C for the high-temperature variant).
2. Unscrew the electrode from the electrode holder using suitable pliers (in the case of a rod electrode) or a 7-mm flat spanner (in the case of a rope electrode) and a 10-mm flat spanner (on the electrode holder side).
3. Apply glue on the thread of the new electrode to secure the threaded joints (the amount of glue is provided by the manufacturer). The glue must meet application-specific requirements, e.g. must resist high temperatures, corrosion, chemicals, or must be approved for use in the food industry.

4. Screw the electrode tightly into the electrode holder using appropriate pliers or a wrench (on the electrode side) and a 10-mm flat spanner (on the electrode holder side).
5. Let the glued joint cure as recommended by the glue manufacturer; after then, the level meter is ready for installation.
6. Perform the setting of the level meter.



For places to be heated, see "How to replace the measuring electrode".

Fig. 16: A figure of the threaded joint of the electrode holder and the rod electrode

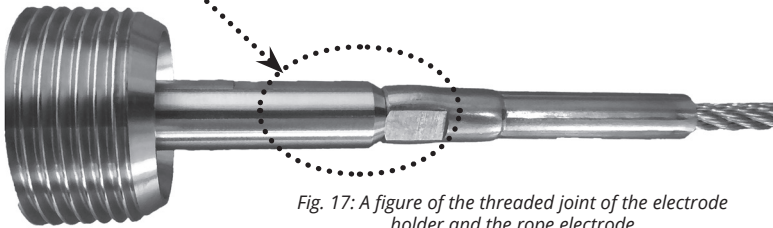

Fig. 17: A figure of the threaded joint of the electrode holder and the rope electrode

How to shorten the measuring electrode – applies only to variants 10, 13, and 30

1. If necessary, remove the rod electrode or rope electrode from the electrode holder – see points 1 and 2 of "How to replace the measuring electrode".
2. Shorten the rod electrode with a suitable metal saw and grind the electrode end. The length of this electrode must be by 7 mm shorter than the dimension "E", see Fig. 15. For the rope electrode, the three fixing screws on the weight have to be loosened, and the rope end must be pulled out, see Fig. 18. After shortening, make sure that the length of the rope is appropriate – the rope is recessed in the weight up to approximately 60 mm. For the rope shortening, cutting pliers are the best option. Be careful not to fray the end of the rope.
3. Slide the rope back into the weight and secure it by tightening all three screws.
4. If the electrode has been removed from the electrode holder, reassemble them – see points from 3 to 7 of "How to replace the measuring electrode".

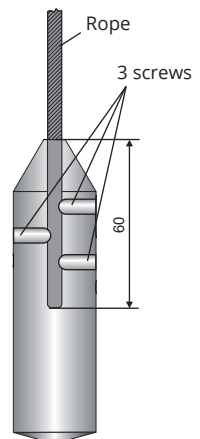

Fig. 18: Drawing of the rope electrode weight

13. ORDER CODE

PRODUCT	
CLM-70	
PERFORMANCE	
N	non-explosive areas
NT	high temperature performance, non-explosive areas
TYPE AND PERFORMANCE OF ELECTRODE	
00	without electrode, CI50 process connection cannot be selected
10	uncoated stainless steel rod electrode, length 0.2 ... 8 m, CI50 process connection cannot be selected
11	fully coated stainless steel rod electrode (PFA insulation), length 0.2 ... 3 m, NPT process connection cannot be selected
12	fully coated stainless steel rod electrode (FEP insulation), length 0.2 ... 3 m, NPT process connection cannot be selected
13	semi-coated rod electrode (FEP insulation), NPT process connection cannot be selected, length 0.5...8 m
20	uncoated stainless steel rod electrode with reference tube, can only be used with G1 process connection, length 0.2 ... 3 m
22	coated stainless steel rod electrode with reference tube (FEP insulation), can only be used with G1 process connection, length 0.2 ... 3 m
30	uncoated rope electrode, length 1 ... 20 m, CI50 process connection cannot be selected
31	uncoated rope electrode with anchor, length 1 ... 20 m, CI50 process connection cannot be selected
32	electrode with insulated cable (FEP) and insulated weight (PTFE), length 1 ... 12 m, NPT process connection cannot be selected
61	two fully coated stainless steel rod electrodes (PFA insulation), length 0.2 ... 2 m, not applicable for NT performance, can only be used with G1½ process connection
PROCESS CONNECTION	
G1	pipe thread G1", cannot be selected for performance type 61
G1½	pipe thread G1½", can only be selected for performance type 61
CI50	Tri-Clamp Ø 50.5 mm, can only be selected for performance types 11, 12, 13, 32
NPT	NPT 1" thread , can only be selected for performance types 00, 10, 30, 31, cannot be used for NT performance type
OUTPUT TYPE	
I	current (4 ... 20 mA)
ELECTRICAL CONNECTION	
B	short cable gland
H	cable gland for protective hose
SET-UP ELEMENTS	
D	basic version with OLED display
C	version with LCD display
L	without display, full cap
LENGTH OF ELECTRODE	
E	electrode length in mm
CLM-70 N - 11 - G1 - I - B - D E 1000	
AVAILABLE PRODUCT ALTERNATIVES	

14. FAILURE STATUS INDICATION

Failure statuses are indicated using:

- Display module (see chapter 9)
- Setting the failure current to the value selected in MENU – SERVICE – FAILURE MODE
- Status messages in HART® communication (applies to the current version with HART® communication – I)

15. ACCESSORIES

standard (included in the price of the unit)

- 1× seal (asbestos-free), other seals by request (PTFE, Al, etc.)*

optional (for an extra fee)

- steel welding flange ON-G1, G1½
- stainless steel welding flange NN-G1, G1½
- fixing nut UM-G1, G1½ (stainless steel, plastic)
- anchor roll KV-31 (for CLM-70-31 only)
- dust proof bushing PR-31 (for CLM-70-31 only)
- extension cable for PK-70-1 display

* Except type 61. For pressure resistance see the table in the accessories datasheet – seals

16. SAFETY, PROTECTION, COMPATIBILITY AND EXPLOSION PROOF

The level meter is equipped with protection against fault voltage on the electrode, supply voltage polarity reversal, short-term overvoltage, and current overload on the output.

Protection against direct contact is ensured:

- by safe voltage EN 61140

Electromagnetic compatibility is in accordance with the following standards:

- EN 55 011 (B), EN 61326-1, EN 61000-4-2 (A, 30kV)
- EN 61000-4-3 (A, 10V), EN 61000-4-4 (A, 2kV)
- EN 61000-4-5 (A, 2kV), EN 61000-4-6 (A, 10V)

This equipment has been issued with a Declaration of Conformity pursuant to Act No. 90/2016 Sb., as amended. The electrical equipment supplied complies with the requirements of applicable government regulations on safety and electromagnetic compatibility.

17. USE, MANIPULATION, AND MAINTENANCE

The level meter requires no operator to work. During operation, the operator of the technological unit is informed of the measured substance level via a related display device and via the level meter display at the installation site.

Maintenance of the device consists in checking the integrity of the level meter and the supply cable. Depending on the nature of the substance to be measured, an inspection of the measuring electrode of the radar level meter is recommended to perform at least once a year. In the case of any visible defects, the device manufacturer or dealer must be contacted immediately.



The device must be installed in such a way that the rope electrode of the level meter is not tensile overloaded, see "Technical Specifications".



Any changes or interventions without the permission of the manufacturer are forbidden to be performed on the CLM-70 level meter. Any repairs must be carried out only at the manufacturer site or by a service organization authorized by the manufacturer. The assembly, installation, commissioning, operation, and maintenance of the CLM-70 level meter must be performed following this manual and must comply with the provisions of the applicable standards for the installation of electrical equipment.

18. MARKING OF LABELS

Labels for the device of CLM-70-_-_-I-_- type:

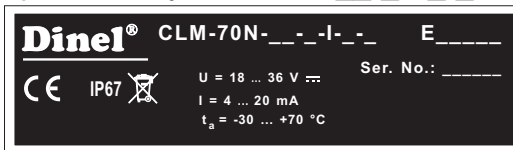

Temperature range as per type:

02	ta = -30 ... +70 °C
06	ta = -30 ... +70 °C
10	ta = -30 ... +60 °C
20	ta = -30 ... +60 °C

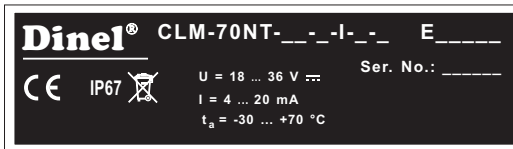

The manufacturer's mark: Dinel® logo

Website: www.dinel.cz

Type of level meter: CLM-70-_-_-I-_-

Serial number of the product: Ser. No.: xxxxx - (from the left: production year, serial production number)

Supply voltage: U = 18 ... 36 V =

Output current range: I = 4 ... 20 mA

Ambient temperature range: $t_a = -30 \dots + _ _ \text{ °C}$ (see Temperature range as per type)

Protection class: IP67

The conformity mark: **CE**

The symbol for waste disposal (WEEE):

19. MENU STRUCTURE

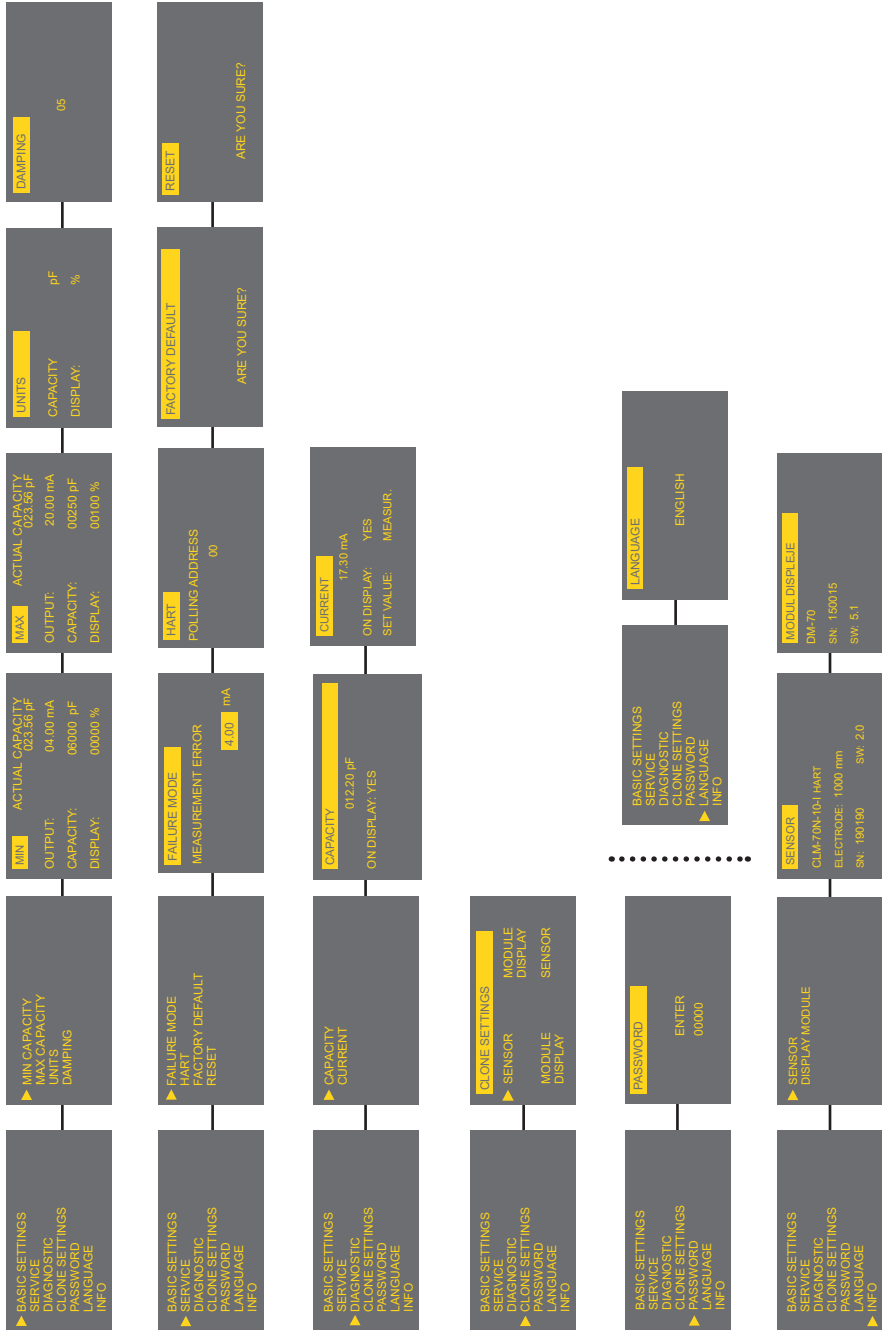

20. TECHNICAL SPECIFICATIONS

TECHNICAL SPECIFICATIONS - LEVEL METER	
Supply voltage	18 ... 36 V DC
Output	4 ... 20 mA (two-wire), HART®
Current output resolution	10uA
Capacity range	0 až 3000 pF
Resolution	0.01 pF for capacities from 0 to 300 pF 0.1 pF for capacities from 300 to 3,000 pF
Temperature error (for a temperature range from -30 to 70 °C)	<1 pF do 100 pF <1% of the measured value from 100 to 3,000 pF
Measuring frequency	100 to 800 kHz
Non-linearity (electronics)	max. 1%
Damping (time constant)	Adjustable 0 .. 99 s
Maximum slew rate	<1s (0 .. 100%) ; for damping 0 s
Current output error	max. 80 uA
Display / settings	display module
Protection class	IP67
Maximum length of measuring electrodes	see dimensional drawing
Ambient temperature range	-30°C to +70°C
Recommended cable	PVC 2x0,75 mm ² shielded
Maximum load resistance of current output R _{max} at the voltage of - 24V DC / 22V DC / 20V DC	270 Ω / 180 Ω / 90 Ω2)
Cable gland tightening torque	3 Nm
Weight - without electrode	approx. 0,5 kg (1 kg variant NT)

TECHNICAL SPECIFICATIONS – DISPLAY MODULE		
Display type	matrix OLED, LCD ¹⁾	
Resolution	128 x 64 pixels	
Digit height / Number of displayed digits of the measured quantity	9 mm / 5 digits	
Display colour	OLED	yellow
	LCD	black with white background light
Type of keys	membrane type with low travel distance	
Ambient temperature range	OLED	-30 ... +70°C
	LCD	-20 ... +70°C
Weight	46 g	

1) OLED – suitable for internal applications and applications at reduced lighting levels. LCD – suitable for outdoor applications, especially with direct sunlight.

5) Including resistor 250R with connection with HART.

USED MATERIALS

sensor part	type variant	standard material
Lid	all	aluminium alloy with surface finish (paint)
Glass	all	polycarbonate
Body	all	aluminium alloy with surface finish (paint)
Cable gland	CLM-70N(NT, Xi, XiT)	plastic - polyamide
	CLM-70Xd(XdT)	metal - nickel-plated brass
Housing (threaded head or Tri-Clamp)	all, except type 61	stainless steel W. Nr. 1.4404 (AISI 316 L)
	CLM-70_-61	PTFE
Electrode	CLM-70_-10, 11, 12, 13, 20, 22, 61	stainless steel W. Nr. 1.4404 (AISI 316 L)
	CLM-70_-30, 31, 32	stainless steel W. Nr. 1.4401 (AISI 316)
Reference tube	CLM-70_-20, 22	stainless steel W. Nr. 1.4301 (AISI 304)
Electrode coating	CLM-70_-11, 61	PFA
	CLM-70_-12, 13, 22	FEP
	CLM-70_-32	FEP + PTFE weight
Measuring module housing	all	POM
Display and adjustment module	all	POM
Internal embedding of electronics	all	polyurethane sealing compound

DEVICE CLASSIFICATION (according to EN 60079-10-1 and EN 60079-10-2)

sensor performance	electrode type	device classification
CLM-70N	all types	Basic performance for use in non-explosive areas.
CLM-70NT	all types	High-temperature performance for use in non-explosive areas (max. 200 °C)

PROCESS CONNECTION

name	dimension	marking
Pipe thread	G 1" (for type CLM-70_-61 G1½)	G1 (for type 61 G1½)
Tapered pipe thread	NPT 1"	NPT
Seamless connection – Tri-Clamp	ø 50,5 mm	CI50

TEMPERATURE AND PRESSURE RESISTANCE

performance variant	temperature tm	temperature tp	temperature ta	max. overpressure for temperature tp	
				up to 30°C	up to 85°C
CLM-70N-10	-40°C ... +300°C	-40°C ... +85°C	-30°C ... +70°C	15 MPa	10 MPa
CLM-70N-11(12,13)	-40°C ... +200°C	-40°C ... +85°C	-30°C ... +70°C	4 MPa	2,5 MPa
CLM-70N-20	-40°C ... +200°C	-40°C ... +85°C	-30°C ... +70°C	15 MPa	10 MPa
CLM-70N-22	-40°C ... +200°C	-40°C ... +85°C	-30°C ... +70°C	4 MPa	2 MPa
CLM-70N-30 (31 s KV)	-40°C ... +200°C	-40°C ... +85°C	-30°C ... +70°C	15 MPa	10 MPa
CLM-70N-31 s PR	-40°C ... +130°C	-40°C ... +85°C	-30°C ... +70°C	15 MPa	10 MPa
CLM-70N-32	-40°C ... +130°C	-40°C ... +85°C	-30°C ... +70°C	1 MPa	0,5 MPa
CLM-70N-61	-40°C ... +200°C	-40°C ... +85°C	-30°C ... +70°C	0,1 MPa	0,1 MPa

TEMPERATURE AND PRESSURE RESISTANCE (high-temperature performance)

performance variant	temperature t_m	temperature t_p	temperature t_a
CLM-70NT-10	-40°C ... +300°C	-40°C ... +200°C	-30°C ... +70°C
CLM-70NT-11(12,13)	-40°C ... +200°C	-40°C ... +200°C	-30°C ... +70°C
CLM-70NT-20(22)	-40°C ... +200°C	-40°C ... +200°C	-30°C ... +70°C
CLM-70NT-30 (31 s KV)	-40°C ... +200°C	-40°C ... +130°C	-30°C ... +70°C
CLM-70NT-31 s PR	-40°C ... +130°C	-40°C ... +130°C	-30°C ... +70°C
CLM-70NT-32	-40°C ... +130°C	-40°C ... +130°C	-30°C ... +70°C
CLM-70NT-61	-	-	-

PRESSURE RESISTANCE (high-temperature performance)

performance variant	maximum overpressure for temperature t_p				
	up to 30°C	up to 85°C	up to 130°C	up to 160°C	up to 200°C
CLM-70NT-10(20, 30)	15 MPa	10 MPa	3 MPa ¹⁾	2 MPa ¹⁾	1 MPa ¹⁾
CLM-70NT-11(12,13,22)	4 MPa	2,5 MPa	2 MPa	1,5 MPa	0,3 MPa
CLM-70NT-32	1 MPa	0,5 MPa	0,1 MPa	-	-
CLM-70NT-61(31)	-	-	-	-	-

1). The above-mentioned values do not apply to hot water, aqueous solutions and steam, in such cases the use must be consulted with the manufacturer.

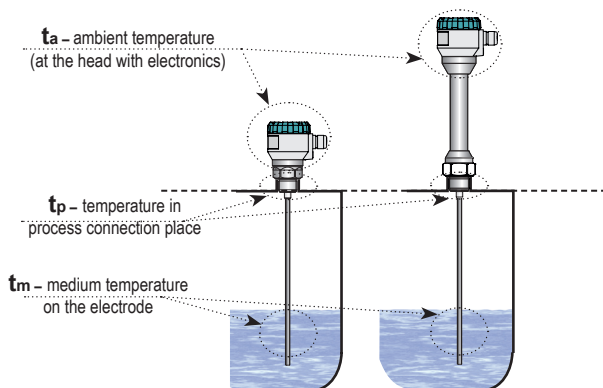

Fig. 19: Illustration of temperature measurement areas

TABLE OF DEFAULT SETTINGS

MIN CAPACITY	0 pF
MIN DISPLAY	0%
MAX CAPACITY	300 pF
MAX DISPLAY	100%
UNITS	pF capacity; Display %
DAMPING	2s
FAILURE MODE	LAST VALUE
POLLING ADDRESS (HART®)	00
PASSWORD	NO PASSWORD

21. ERROR CODES

ERROR CODES		
ERROR NUMBER	CAUSE	REMEDY
ERROR 1	Measuring module failure or short circuit on the electrode	Remove the short circuit on the electrode. If you are unable to eliminate the failure, contact the manufacturer.
ERROR 2	Current output error	Contact the manufacturer.
ERROR 3	Too low capacity (< 3 pF)	Inadequate contact of an electronic part and head. Check that the electronic component is fitted correctly in the head. If you are unable to eliminate the failure, contact the manufacturer.
ERROR 4	Too high measured capacity (> 2995 pF)	Reduce the measured capacity to the level meter range.
ERROR 8	Internal error of the level meter	Contact the manufacturer.

in case of multiple errors, "Error" and individual error codes are displayed (e.g. Error 1 3).

22. PACKING, SHIPPING AND STORAGE

The CLM-70 is wrapped in a polyethylene bag and the whole consignment is placed in a cardboard box. In the cardboard box, appropriate padding is used to prevent mechanical damage during transport.

By taking out the device of the packing material just before its use, you can eliminate possible damage.

Transport to the customer is performed by a forwarding company. After a prior agreement, personal delivery of the ordered goods from the company headquarters is also possible. When taking over, please make sure that the consignment is complete and corresponds to the extent of the order, and that no damage occurred to the device during transport. Do not use if the device was obviously damaged during transport, but contact the manufacturer in order to resolve the situation.

If the device is to be retransported, then only wrapped in the original packing material and protected against shocks and weather conditions.

Store the device in the original packing material in dry areas covered from the weather conditions, with moisture up to 85% without any effects of chemically active substances. Storage temperature range is from -10 °C to +50 °C.