

Economical Single Display Type, PID Control

Features

- Realizes ideal temp. controlling with newly developed PID control algorithm and 100ms high speed sampling
- **Built-in relay output or SSR output selectable**
: Enables to phase control and cycle control with SSR drive output (SSRP function)
- Dramatically increased visibility using wide display part
- Mounting space saving with compact design
: Approx. 38% reduced size compared with existing model (depth-based)
- SV/PV deviation indicatable



! Please read "Caution for your safety" in operation manual before using.



Ordering Information

T	C	4	S	-	1	4	R	Item	T	Temperature controller
								Setting type	C	Set by touch switch
								Digit	4	9999 (4digit)
								Size	S	DIN W48×H48mm (Terminal block type)
									SP	DIN W48×H48mm (11-pin plug type) ^{※3}
									Y	DIN W72×H36mm
									M	DIN W72×H72mm
									H	DIN W48×H96mm
									W	DIN W96×H48mm
									L	DIN W96×H96mm
								Alarm output	N	No alarm output
									1	Alarm 1 output
									2	Alarm 1 output + Alarm 2 output ^{※2}
								Power supply	2	24VAC 50/60Hz, 24-48VDC
									4	100-240VAC 50/60Hz
								Control output	N	Indicator - Without control output
									R	Relay output + SSR drive output ^{※1}

※1: In case of the AC voltage model, SSR drive output method (standard ON/OFF control, cycle, control, phase control) is available to select.

※2: It is unavailable for TC4SP, TC4Y.

※3: 11-pin socket (PG-11, PS-11(N)) for TC4SP: sold separately.

Specifications

Series	TC4S	TC4SP	TC4Y	TC4M	TC4W	TC4H	TC4L
Power supply	AC power	100-240VAC 50/60Hz					
	AC/DC power	24VAC 50/60Hz, 24-48VDC					
Allowable voltage range	90 to 110% of rated voltage						
Power consumption	AC power	Max. 5VA (100-240VAC 50/60Hz)					
	AC/DC power	Max. 5VA (24VAC 50/60Hz), Max. 3W (24-48VDC)					
Display method	7Segment (red), Other display (green, yellow, red) LED						
Character size (W×H)	7.0×15.0mm		7.4×15.0mm	9.5×20.0mm	9.5×20.0mm	7.0×14.6mm	11.0×22.0mm
Input type	RTD	DPT100Ω, Cu50Ω (allowable line resistance max. 5Ω per a wire)					
	Thermocouple	K (CA), J (IC), L (IC)					
Display accuracy ^{※1}	RTD	• At room temperature (23°C±5°C): (PV ±0.5% or ±1°C, select the higher one) ±1digit • Out of room temperature range: (PV ±0.5% or ±2°C, select the higher one) ±1digit					
	Thermocouple	※For TC4SP, add ±1°C by accuracy standard.					

※1: Thermocouple L (IC) type, RTD Cu50Ω

• At room temperature (23°C ±5°C): (PV ±0.5% or ±2°C, select the higher one) ±1digit

• Out of room temperature range: (PV ±0.5% or ±3°C, select the higher one) ±1digit

In case of TC4SP Series, ±1°C will be added.

Economical PID Control

Specifications

Series	TC4S	TC4SP	TC4Y	TC4M	TC4W	TC4H	TC4L
Control output	Relay	250VAC 3A 1a					
	SSR	12VDC \pm 2V 20mA Max.					
Alarm output	AL1, AL2 Relay: 250VAC 1A 1a (※TC4SP, TC4Y have AL1 only.)						
Control method	ON/OFF and P, PI, PD, PID control						
Hysteresis	1 to 100°C/°F (0.1 to 50.0°C/°F) variable						
Proportional band (P)	0.1 to 999.9°C/°F						
Integral time (I)	0 to 9999 sec.						
Derivative time (D)	0 to 9999 sec.						
Control period (T)	0.5 to 120.0 sec.						
Manual reset	0.0 to 100.0%						
Sampling period	100ms						
Dielectric strength	AC power	2,000VAC 50/60Hz for 1min. (between input terminal and power terminal)					
	AC/DC power	1,000VAC 50/60Hz for 1min. (between input terminal and power terminal)					
Vibration	0.75mm amplitude at frequency of 5 to 55Hz (for 1 min.) in each X, Y, Z direction for 2 hours						
Relay life cycle	Mechanical	OUT: Over 5,000,000 operations, AL1/2: Over 5,000,000 operations					
	Electrical	OUT: Over 200,000 operations (250VAC 3A resistive load) AL1/2: Over 300,000 operations (250VAC 1A resistive load)					
Insulation resistance	Min. 100M Ω (at 500VDC megger)						
Noise immunity	Square-wave noise by noise simulator (pulse width 1us) \pm 2kV R-phase and S-phase						
Memory retention	Approx. 10 years (when using non-volatile semiconductor memory type)						
Environment	Ambient temperature	-10 to 50°C, Storage: -20 to 60°C					
	Ambient humidity	35 to 85%RH, Storage: 35 to 85%RH					
Insulation type	Double insulation or reinforced insulation (mark: \square). Dielectric strength between the measuring input part and the power part: AC power 2kV, AC/DC Power 1kV)						
Approval	CE c R us						
Weight ^{※2}	Approx. 141g (approx. 94g)	Approx. 123g (approx. 76g)	Approx. 174g (approx. 85g)	Approx. 204g (approx. 133g)	Approx. 194g (approx. 122g)	Approx. 194g (approx. 122g)	Approx. 254g (approx. 155g)

※2: The weight includes packaging. The weight in parentheses is for unit only.

※Environment resistance is rated at no freezing or condensation.

Connections

※TC4 Series has selectable control output; Relay output, and SSR drive output. AC/DC power type does not have SSRP function.

TC4S

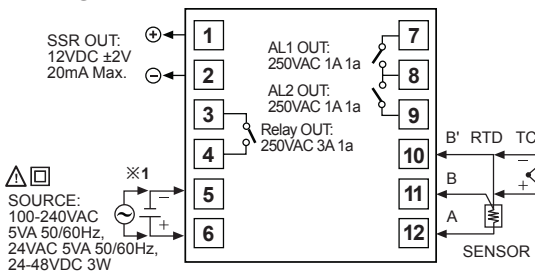

TC4SP

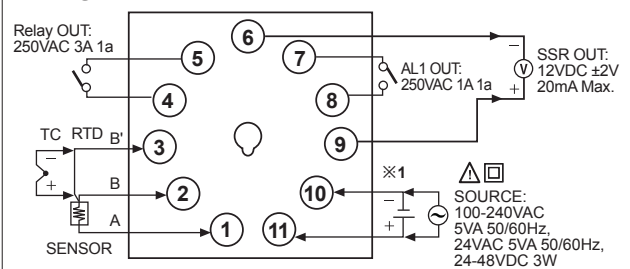

TC4Y

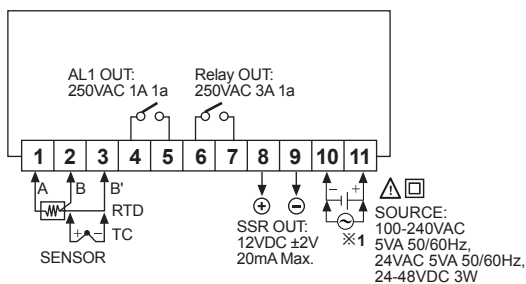

※1: AC power: 100-240VAC 5VA 50/60Hz
AC/DC power: 24VAC 5VA 50/60Hz, 24-48VDC 3W

TC4W

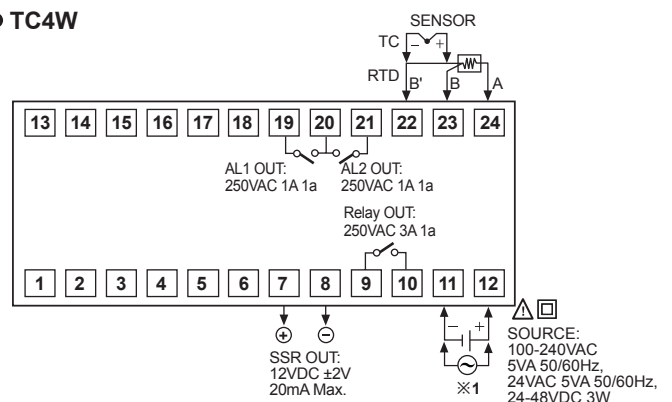

TC Series

● TC4M

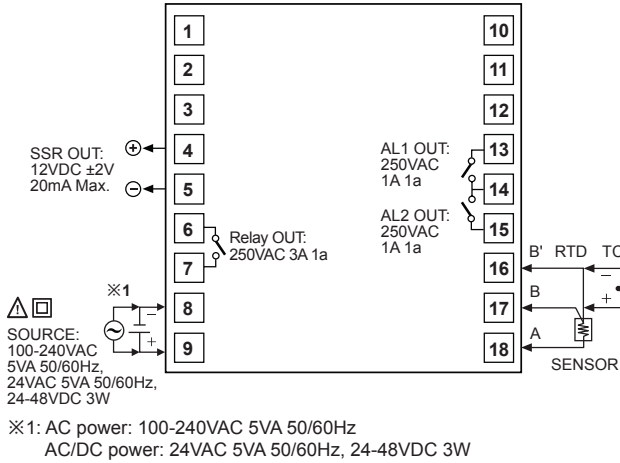

● TC4H/L

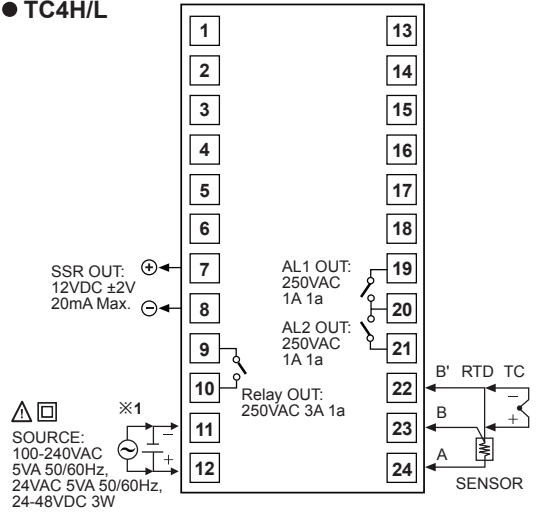

■ Dimensions

(unit: mm)

● TC4S

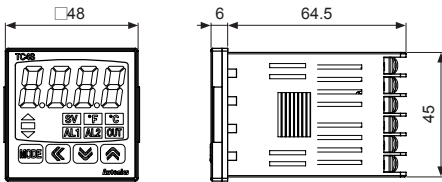

● TC4SP

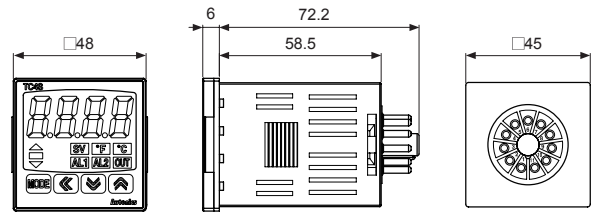

● TC4Y

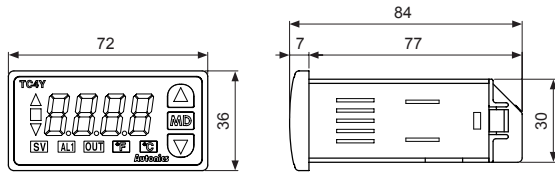

● TC4W

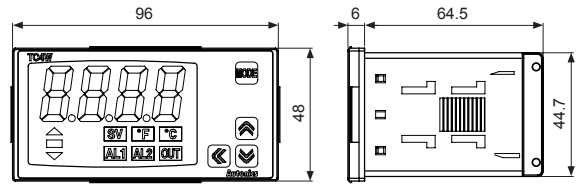

● TC4M

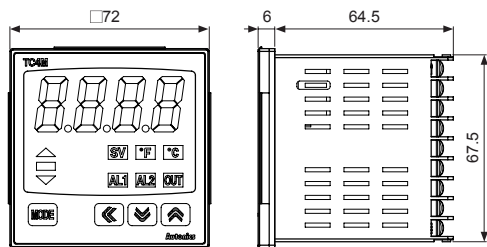

● TC4H

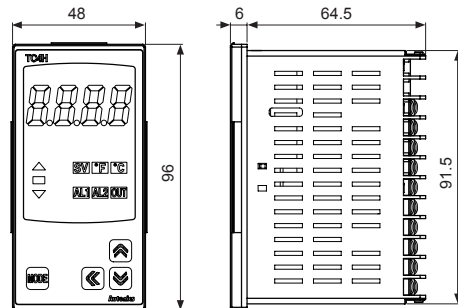

Economical PID Control

● TC4L

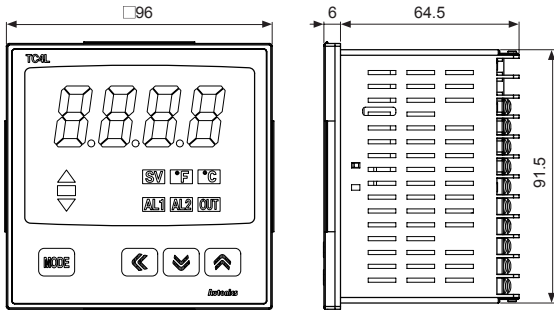

● Panel cut-out

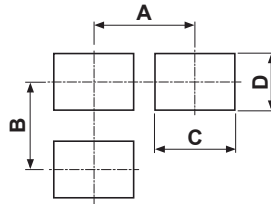

Model \ Size	A	B	C	D
TC4S	Min. 65	Min. 65	45 ^{+0.6} ₀	45 ^{+0.6} ₀
TC4SP	Min. 65	Min. 65	45 ^{+0.6} ₀	45 ^{+0.6} ₀
TC4Y	Min. 91	Min. 40	68 ^{+0.7} ₀	31.5 ^{+0.5} ₀
TC4M	Min. 90	Min. 90	68 ^{+0.7} ₀	68 ^{+0.7} ₀
TC4H	Min. 65	Min. 115	45 ^{+0.6} ₀	92 ^{+0.8} ₀
TC4W	Min. 115	Min. 65	92 ^{+0.8} ₀	45 ^{+0.6} ₀
TC4L	Min. 115	Min. 115	92 ^{+0.8} ₀	92 ^{+0.8} ₀

● Bracket

● TC4S/TC4SP Series

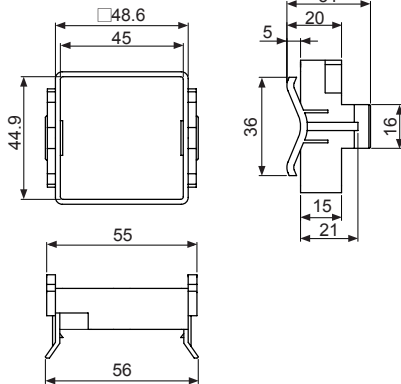

● TC4Y Series

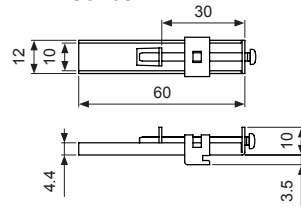

● TC4M, TC4W, TC4H, TC4L Series

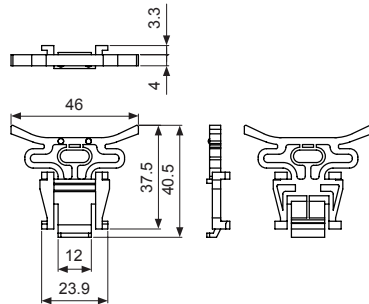

● Terminal cover (sold separately)

● RSA-COVER (48×48mm)

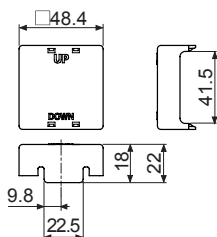

● RMA-COVER (72×72mm)

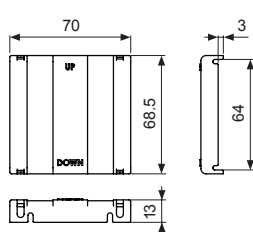

● RHA-COVER (48×96mm)

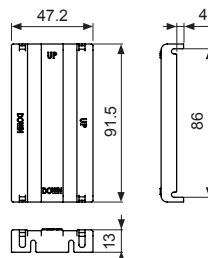

● RLA-COVER (96×96mm)

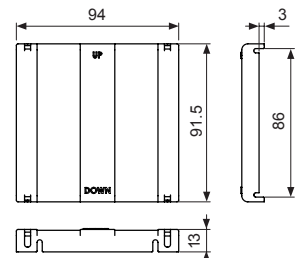

TC Series

Unit Description

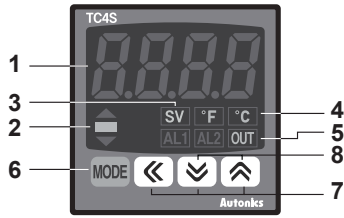

1. Present temperature (PV) display

- RUN mode: Present temperature (PV) display.
- Parameter setting mode: Parameter or parameter setting value display.

2. Deviation indicator, Auto-tuning indicator

It shows current temperature (PV) deviation based on set temperature (SV) by LED.

No.	PV deviation temp.	Deviation display
1	Over 2°C	▲ indicator ON
2	Below ±2°C	■ indicator ON
3	Under -2°C	▼ indicator ON

The deviation indicators (▲, ■, ▼) flash by every 1 sec. when operating auto tuning.

3. Set temperature (SV) indicator

Press any front key once to check or change current set temperature (SV), the set temperature (SV) indicator is ON and preset set value is flashed.

4. Temperature unit (°C/°F) indicator

It shows current temperature unit.

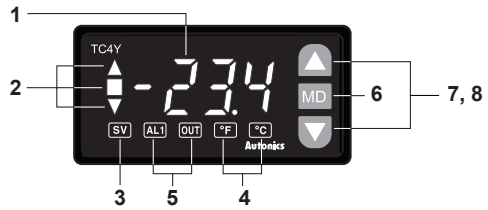

5. Control/alarm output indicator

- OUT: It will turn ON when control output (Main Control Output) is ON.

※In case of CYCLE/PHASE control of SSR drive output, it will turn ON when MV is over 3.0%. (only for AC voltage type)

- AL1/AL2: It will light up when alarm output Alarm 1/ Alarm 2 are on.

6. MODE key

Used when entering into parameter group, returning to RUN mode, moving parameter, and saving setting values.

7. Adjustment

Used when entering into set value change mode, digit moving and digit up/down.

8. FUNCTION key

Press $\left[\text{F} \right] + \left[\text{F} \right]$ keys for 3 sec. to operate function (RUN/STOP, alarm output cancel, auto-tuning) set in inner parameter [d1 - d].

- ※Press $\left[\text{F} \right] + \left[\text{F} \right]$ keys at the same time in set value operation to move digit.

SV Setting

※In case of changing set temperature from 210°C to 250°C.

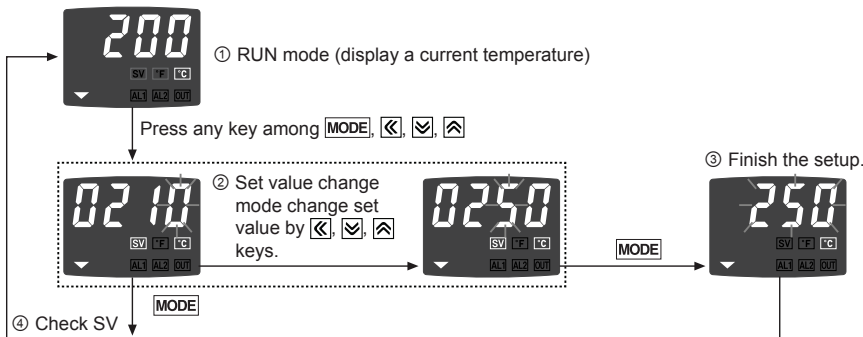

Parameter Reset

Reset all parameters as factory default. Hold the front $\left[\text{F} \right] + \left[\text{F} \right] + \left[\text{F} \right]$ keys for 5 sec., to enter parameter reset [r1 - r] parameter.

Select 'r5' and all parameters are reset as factory default. Select 'no' and previous settings are maintained. If setting parameter lock [L o L] or processing auto-tuning, parameter reset is unavailable.

Economical PID Control

Parameter Group

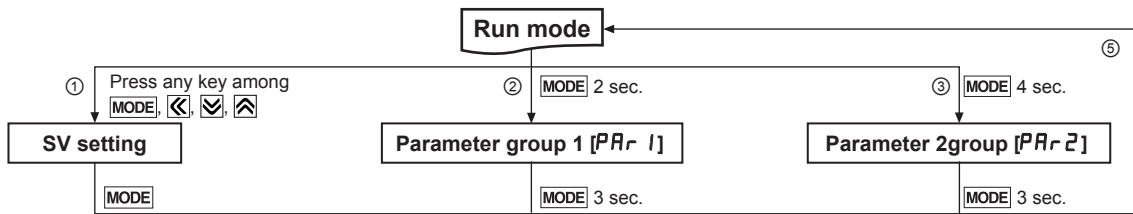

④

AL1	AL1 alarm temperature
AL2	AL2 alarm temperature
At	Auto tuning
P	Proportional band
I	Integral time
d	Derivative time
rSEt	Manual reset (Normal deviation correction)
HYS	ON/OFF control hysteresis

in-t	Input type
Unit	Temperature unit
in-b	Input correction
nAUF	Input digital filter
L-Su	SV low-limit value
H-Su	SV high-limit value
o-Ft	Control output operation
C-nd	Control type
oUt	Control output
SSrn	SSR drive output method ^{※1}
t	Control cycle
AL-1	AL1 alarm operation mode
AL-2	AL2 alarm operation mode
AHYS	Alarm output hysteresis
LbAt	LBA monitoring time
LbAb	LBA detection range
di-U	Digital input key
Ernu	Control output MV in case of input break error
LoC	Parameter lock

- ※1: It is not displayed for AC/DC power model (TC4□□2R).
- ※If no key entered for 30 sec., it returns to RUN mode automatically and the set value of parameter is not be saved.
- ※: [] This parameter might not be displayed depending on other parameter settings.
- ① Press any key once in RUN mode, it advances to set value setting group.
- ② Press **MODE** key over 2sec. in RUN mode, it advances to parameter group 1.
- ③ Press **MODE** key over 4sec. in RUN mode, it advances to parameter group 2.
- ④ First parameter will be displayed on viewer when it advances to the setting group.
- ⑤ Press **MODE** key over 3sec. in the setting group, it returns to RUN mode.
 - ※Exception: Press **MODE** key once in SV setting group it returns to RUN mode.
- ※Press **MODE** key again within a sec after return to RUN mode by press **MODE** key over 3sec., it advances to the first parameter of previous setting group.

※Parameter setup



- Set parameter as the above considering parameter relation of each setting group.
- Check parameter set value after change parameter of setting group 2.

※Indicator model (TC4□-N□N) displays shaded parameter (■) of parameter group 2.

※Alarm operation mode [AL-1, AL-2] parameter of parameter group 2 is decided whether to display according by alarm output type.

※If alarm operation mode [AL-1, AL-2] of parameter group 2 is set to An□□ / SbA□□ / LbA□□, AHYS parameter is not displayed.

TC Series

Parameter Group 1

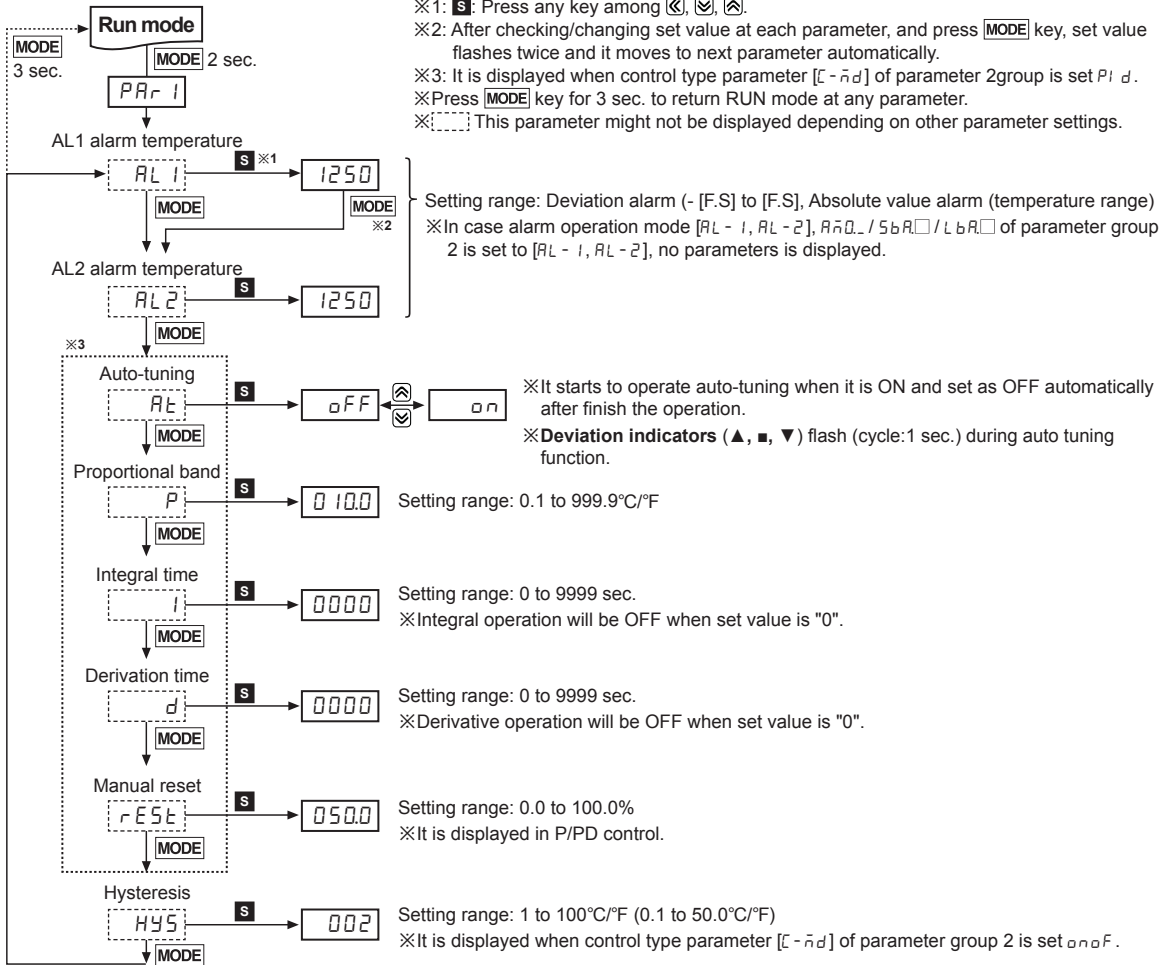

※1: **S**: Press any key among \leftarrow , \rightarrow , \uparrow , \downarrow .

※2: After checking/changing set value at each parameter, and press **MODE** key, set value flashes twice and it moves to next parameter automatically.

※3: It is displayed when control type parameter [C-nd] of parameter 2group is set P1d.

×Press **MODE** key for 3 sec. to return RUN mode at any parameter.

×[]: This parameter might not be displayed depending on other parameter settings.

Setting range: Deviation alarm (- [F.S] to [F.S], Absolute value alarm (temperature range)
×In case alarm operation mode [AL-1, AL-2], ANO- / SBAR□ / LbAR□ of parameter group 2 is set to [AL-1, AL-2], no parameters is displayed.

×It starts to operate auto-tuning when it is ON and set as OFF automatically after finish the operation.

×Deviation indicators (\blacktriangle , \blacksquare , \blacktriangledown) flash (cycle:1 sec.) during auto tuning function.

Parameter Group 2

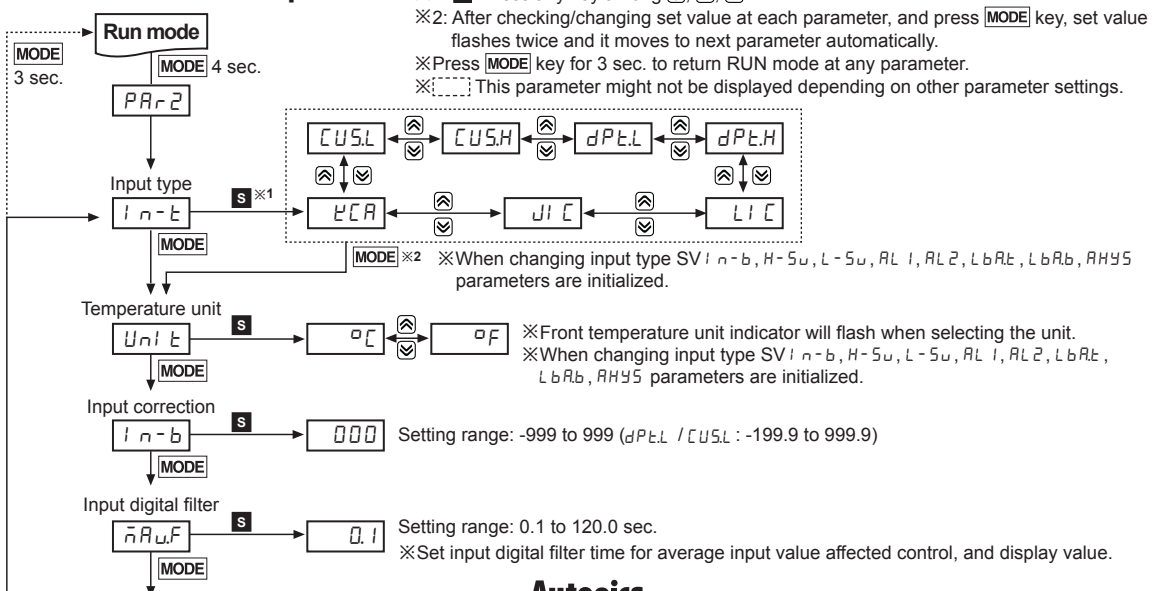

※1: **S**: Press any key among \leftarrow , \rightarrow , \uparrow , \downarrow .

※2: After checking/changing set value at each parameter, and press **MODE** key, set value flashes twice and it moves to next parameter automatically.

×Press **MODE** key for 3 sec. to return RUN mode at any parameter.

×[]: This parameter might not be displayed depending on other parameter settings.

×When changing input type SVint, H-5u, L-5u, AL1, AL2, LbARt, LbARb, AHYS parameters are initialized.

Economical PID Control

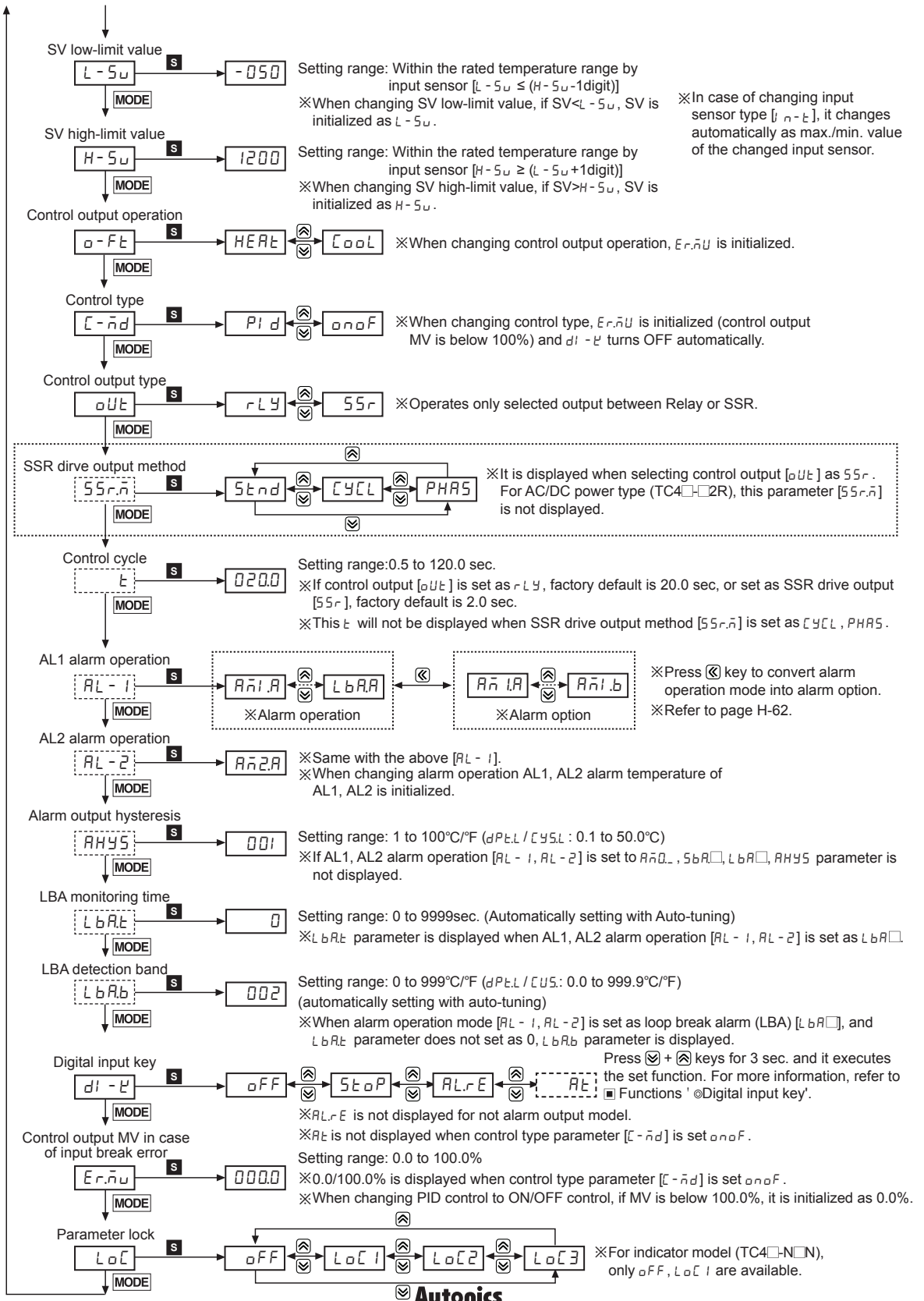

TC Series

Input Sensor And Temperature Range [i n - t]

Input sensor		Display	Input range (°C)	Input range (°F)
Thermocouple	K (CA)	℄℄℄	-50 to 1200	-58 to 2192
	J (IC)	℄℄℄	-30 to 500	-22 to 932
	L (IC)	℄℄℄	-40 to 800	-40 to 1472
RTD	DPT100Ω	℄℄℄℄	-100 to 400	-148 to 752
		℄℄℄℄	-100.0 to 400.0	-148.0 to 752.0
	Cu50Ω	℄℄℄℄	-50 to 200	-58 to 392
		℄℄℄℄	-50.0 to 200.0	-58.0 to 392.0

Factory Default

SV setting

Parameter	Factory default
-	0

Parameter group 1

Parameter	Factory default
RL 1	1250
RL 2	
RL	oFF
P	0 10.0
i	0000
d	0000
rES℄	0500
HYS	002

Parameter group 2

Parameter	Factory default	Parameter	Factory default
i n - t	℄℄℄	t	0200
U n i t	°℄	RL - 1	R n 1 ℄
i n - b	0000	RL - 2	R n 2 ℄
nARuF	000.1	RLYS	000 1
L - Su	-050	LbRLt	0000
H - Su	1200	LbRlb	002
o - F℄	HEAR℄	d i - ℄	StoP
℄ - n d	P i d	Er.nu	0000
oU℄	rLY	L o ℄	oFF
SSr.n	Stnd		

※AC/DC power type has no SSR drive output method [55r.n] and supports only ON/OFF output when selecting 55r in control output [oU℄].

Mounting

TC4S/SP (48×48mm) Series

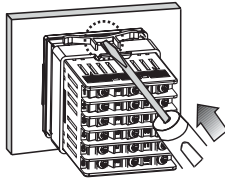

TC4Y (72×36mm) Series

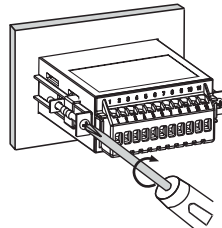

Other Series

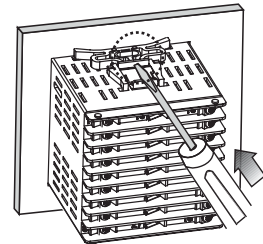

※Mount the product on the panel, fasten bracket by pushing with tools as shown above.
(In case of TC4Y, fasten bolts for bracket.)

Economical PID Control

■ Functions

◎ Alarm [AL - 1 / AL - 2]

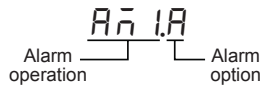

Set both alarm operation and alarm option by combining. Each alarm operates individually in two alarm output models. When the current temperature is out of alarm range, alarm clears automatically. If alarm option is alarm latch or alarm latch and standby sequence 1/2, press digital input key [F+H] 3 sec., digital input key [d1 - 2] of Parameter group 2 set as AL-E, or turn OFF the power and turn ON to clear alarm.

● Alarm operation

Mode	Name	Alarm operation	Description
Rn0	—	—	No alarm output
Rn1	Deviation high-limit alarm	<p>High deviation: Set as 10°C High deviation: Set as -10°C</p>	If deviation between PV and SV as high-limit is higher than set value of deviation temperature, the alarm output will be ON.
Rn2	Deviation low-limit alarm	<p>Lower deviation: Set as 10°C Lower deviation: Set as -10°C</p>	If deviation between PV and SV as low-limit is higher than set value of deviation temperature, the alarm output will be ON.
Rn3	Deviation high/low-limit alarm	<p>High/Lower deviation: Set as 10°C</p>	If deviation between PV and SV as high/low-limit is higher than set value of deviation temperature, the alarm output will be ON.
Rn4	Deviation high/low-limit reserve alarm	<p>High/Lower deviation: Set as 10°C</p>	If deviation between PV and SV as high/low-limit is higher than set value of deviation temperature, the alarm output will be OFF.
Rn5	Absolute value high limit alarm	<p>Absolute-value Alarm: Set as 90°C Absolute-value Alarm: Set as 110°C</p>	If PV is higher than the absolute value, the output will be ON.
Rn6	Absolute value low limit alarm	<p>Absolute-value Alarm: Set as 90°C Absolute-value Alarm: Set as 110°C</p>	If PV is lower than the absolute value, the output will be ON.
SbA	Sensor break Alarm	—	It will be ON when it detects sensor disconnection.
LbA	Loop break Alarm	—	It will be ON when it detects loop break.

※ H: Alarm output hysteresis [RHYS]

● Alarm option

Mode	Name	Description
RnA	Standard alarm	If it is an alarm condition, alarm output is ON. If it is a clear alarm condition, alarm output is OFF.
Rnb	Alarm latch	If it is an alarm condition, alarm output is ON and maintains ON status. (Alarm output HOLD)
Rn1c	Standby sequence 1	First alarm condition is ignored and from second alarm condition, standard alarm operates. When power is supplied and it is an alarm condition, this first alarm condition is ignored and from the second alarm condition, standard alarm operates.
Rn1d	Alarm latch and standby sequence 1	If it is an alarm condition, it operates both alarm latch and standby sequence. When power is supplied and it is an alarm condition, this first alarm condition is ignored and from the second alarm condition, alarm latch operates.
Rn2e	Standby sequence 2	First alarm condition is ignored and from second alarm condition, standard alarm operates. When re-applied standby sequence and if it is alarm condition, alarm output does not turn ON. After clearing alarm condition, standard alarm operates.
Rn2f	Alarm latch and standby sequence 2	Basic operation is same as alarm latch and standby sequence 1. It operates not only by power ON/OFF, but also alarm setting value, or alarm option changing. When re-applied standby sequence and if it is alarm condition, alarm output does not turn ON. After clearing alarm condition, alarm latch operates.

※ Condition of re-applied standby sequence for standby sequence 1, alarm latch and standby sequence 1: Power ON
 Condition of re-applied standby sequence for standby sequence 2, alarm latch and standby sequence 2: Power ON, changing set temperature, alarm temperature [AL 1, AL 2] or alarm operation [AL - 1, AL - 2], switching STOP mode to RUN mode.

◎ Sensor break alarm

The function that alarm output will be ON when sensor is not connected or when sensor's disconnection is detected during temperature controlling. You can check whether the sensor is connected with buzzer or other units using alarm output contact. It is selectable between standard alarm [SbAA], or alarm latch [SbAB].

TC Series

◎ Loop break alarm (LBA)

It checks control loop and outputs alarm by temperature change of the subject. For heating control (cooling control), when control output MV is 100% (0% for cooling control) and PV is not increased over than LBA detection band [L b R b] during LBA monitoring time [L b R t], or when control output MV is 0% (100% for cooling control) and PV is not decreased below than LBA detection band [L b R b] during LBA monitoring time [L b R t], alarm output turns ON.

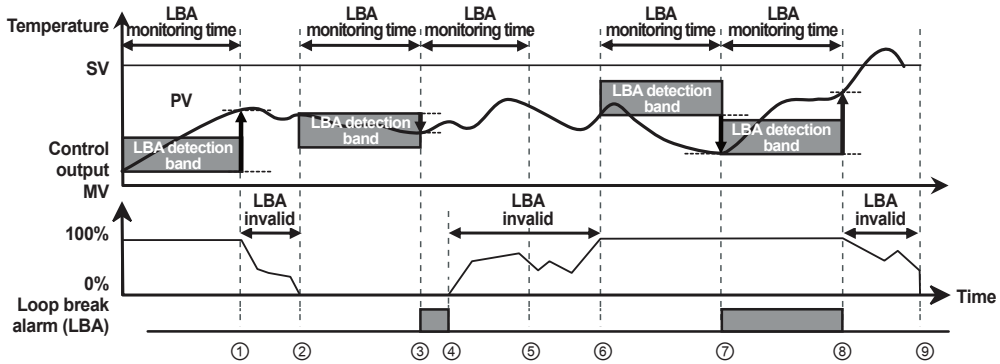

Start control to ①	When control output MV is 0% and PV is not decreased below than LBA detection band [L b R b] during LBA monitoring time [L b R t]
① to ②	The status of changing control output MV (LBA monitoring time is reset.)
② to ③	When control output MV is 0% and PV is not decreased below than LBA detection band [L b R b] during LBA monitoring time [L b R t], loop break alarm (LBA) turns ON after LBA monitoring time.
③ to ④	Control output MV is 0% and loop break alarm (LBA) turns and maintains ON.
④ to ⑥	The status of changing control output MV (LBA monitoring time is reset.)
⑥ to ⑦	When control output MV is 100% and PV is not increased over than LBA detection band [L b R b] during LBA monitoring time [L b R t], loop break alarm (LBA) turns ON after LBA monitoring time.
⑦ to ⑧	When control output MV is 100% and PV is increased over than LBA detection band [L b R b] during LBA monitoring time [L b R t] loop break alarm (LBA) turns OFF after LBA monitoring time.
⑧ to ⑨	The status of changing control output MV (LBA monitoring time is reset.)

※When executing auto-tuning, LBA detection band [L b R b] and LBA monitoring time are automatically set based on auto tuning value. When AL1, AL2 alarm operation [AL - 1, AL - 2] is set as loop break alarm (LBA) [L b R □], LBA detection band [L b R b] and LBA monitoring time [L b R t] parameter is displayed.

◎ SSR drive output function (SSRP function) [55r.n]

- SSRP function is selectable one of standard ON/OFF control, cycle control, phase control by utilizing standard SSR drive output.
- Realizing high accuracy and cost effective temperature control as linear output(cycle control and phase control).
- Select one of standard ON/OFF control [5tnd], cycle control [YCL], phase control [PHAS] at [55r.n] parameter of Parameter group 2. For cycle control, connect zero cross turn-on SSR or random turn-on SSR. For phase control, connect random turn-on SSR.

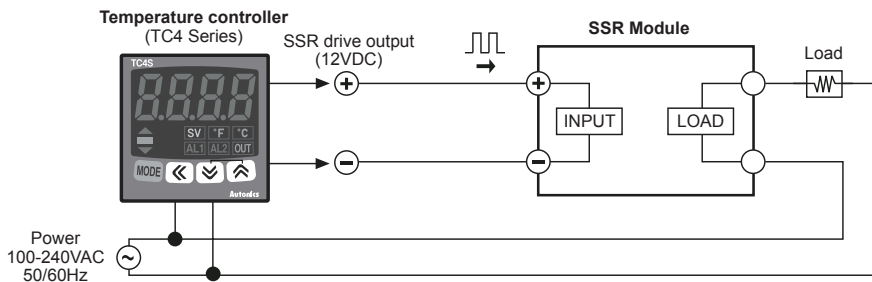

※When selecting cycle or phase control mode, the power supply for load and temperature controller must be the same.

※In case of selecting cycle [YCL] or phase [PHAS] control mode for PID control, control cycle [t] is not allowed to set.

※For AC/DC power model (TC4□-□2R), this parameter [55r.n] is not displayed and it is available only standard control by relay or SSR.

Economical PID Control

● Standard ON/OFF control mode [5E n d]

A mode to control the load in the same way as Relay output type.
(ON: output level 100%, OFF: output level 0%)

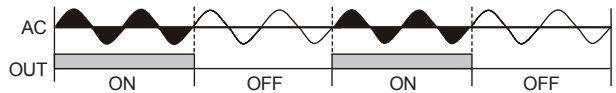

● Cycle control [CY L L]

A mode to control the load by repeating output ON / OFF according to the rate of output within setting cycle.
Having improved ON / OFF noise feature by Zero Cross type.

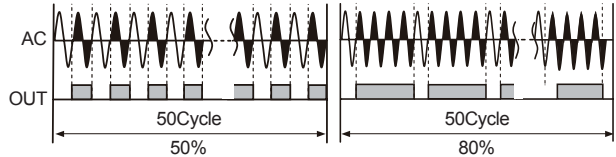

● Phase control [PHAS]

A mode to control the load by controlling the phase within AC half cycle. Serial control is available.
RANDOM Turn-on type SSR must be used for this mode.

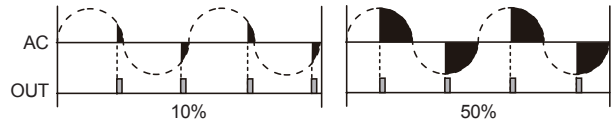

◎ Auto tuning [A E]

- When setting A E parameter to ON, front temperature unit display (°C or °F) indicator will be flickering during Auto tuning. After completing auto tuning, temperature unit display indicator returns to normal operation and A E parameter automatically becomes [ON → OFF].
- Set as OFF to stop auto tuning.
※It keeps previous P, I, D set values.
- If SV is changed during auto tuning mode, auto tuning is stopped.
- PID time constants figured out through auto tuning function can be changed.
- If control method [C - n d] is set to ONOFF, no parameters are displayed.
- Finish auto tuning when [OPEN] error occurs during the operation.
※In case of [OPEN] error, auto tuning operation is not applicable.

◎ Input correction [I n - b]

Controller itself does not have errors but there may be error by external input temperature sensor.

E.g.) If actual temperature is 80°C but controller displays 78°C, set input correction value [I n - b] as 002 and controller displays 80°C.

※As the result of input correction, if current temperature value (PV) is over each temperature range of input sensor, it displays HHHH or LLLL.

◎ Input digital filter [n A L F]

If current temperature (PV) is fluctuating repeatedly by rapid change of input signal, it reflects to MV and stale control is impossible. Therefore, digital filter function stabilizes current temperature value.

- For example, set input digital filter value as 0.4 sec, and it applies digital filter to input values during 0.4 sec and displays this values. Current temperature may be different by actual input value.

◎ Control method selection [C - n d]

It is selectable PID, ON/OFF control.

- In case of ON/OFF [ONOFF] mode, Hysteresis [HY5] parameter is displayed.
- In case of PID [PID] mode, Proportional band [P], Integral time [I], and Derivative time [D] parameters are displayed.

◎ Hysteresis [HY5]

- Set control output ON / OFF interval in ON / OFF control mode.

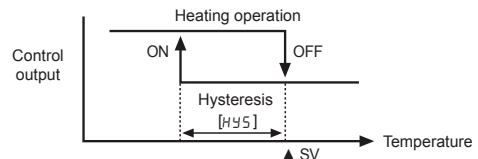

- If Hysteresis is too narrow, hunting (oscillation, chattering) could occur due to external noise.
- In case of ON / OFF control mode, even if PV reaches stable status, there still occurs hunting. It could be due to Hysteresis [HY5] SV, load's response characteristics or sensor's location. In order to reduce hunting to a minimum, it is required to take into following factors consideration when designing temp. controlling; proper Hysteresis [HY5], heater's capacity, thermal characteristics, sensor's response and location.

◎ Temperature unit selection [U n I E]

- A function to select display temperature unit
- Unit display indicator will be ON when converting temperature unit.

TC Series

◎ Manual reset [r E 5 t]

When selecting P/PD control mode, certain temperature difference exists even after PV reaches stable status because heater's rising and falling time is inconsistent due to thermal characteristics of controlled objects, such as heat capacity, heater capacity. This temperature difference is called offset and manual reset [r E 5 t] function is to set/correct offset.

- When PV and SV are equal, reset value is 50.0%. After control is stable, PV is lower than SV, reset value is over 50.0% or PV is higher than SV, reset value is below 50.0%.
- Manual reset [r E 5 t] by control result

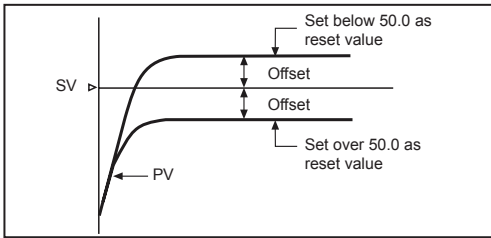

※Manual reset function is applicable only to P / PD control mode.

◎ Control output MV when input sensor line is broken [E r . n u]

The function to set control output MV in case of open error. Users are able to set by ON/OFF setting or MV setting. It executes control output by set MV regardless of ON/OFF or PID control output.

◎ Digital input key (☑ + ⏏ 3sec.) [d l - t]

Parameter		Operation
OFF	o F F	It does not use digital input key function.
RUN/STOP	S t o P	Pauses control output. Auxiliary output (except loop break alarm, sensor break alarm)except Control output operates as setting. Hold the digital input keys for 3 sec. to restart.
Clear alarm	R L r E	Clears alarm output by force. (only when alarm option is alarm latch, or alarm latch and standby sequence 1/2 .) This function is applied when present value is out of alarm operation range but alarm output is ON. Alarm operates normally right after clearing alarm.
Auto-tuning	R t	Starts/Stops auto-tuning. This function is same as auto-tuning[R t] of parameter group 1. (You can start auto-tuning [R t] of parameter group 1 and stop it by digital input key.) ※This parameter R t appears only when control method [c - n d] Parameter group 2 is set as P i d . When control method [c - n d] Parameter group 2 is set as o n o F , this parameter is changed as o F F .

◎ Parameter lock [L o C]

A function to prevent changing SV and parameters of each setting group. Parameter setting values are still possible to check when parameter lock is set.

Display	Description
o F F	Lock off
L o C 1	Lock parameter group 2
L o C 2	Lock parameter group 1, 2
L o C 3	Lock parameter group 1, 2, SV setting

※ o F F , L o C 1 are available only for indicator (TC4□-N□N).

◎ Cool / Heat function [o - F t]

Generally there are two ways to control temperature, one (Heat-function) is to heat when PV is getting down (Heater). The other (Cool-function) is to cool when PV is getting higher (Freezer).

These functions are operating oppositely when it is ON/OFF control or proportional control. But in this case PID time constant will be different due to PID time constant will be decided according to control system when it is PID control.

- Cool-function [c o o L] and heat-function [H E R t] must be set correctly according to the application, if set as opposite function, it may cause a fire. (If set cool-function [c o o L] at heater, it will be maintained ON and it may cause a fire.)
- Avoid changing heat-function to cool-function or cool-function to heat-function when the unit is operating.
- It is impossible to operate both function at once in this unit. Therefore, only one function should be selected only.

◎ SV High/Low limit [H - 5 u / L - 5 u]

- It sets SV high/low limit Limit range of using temperature within temperature range for each sensor, user can set/change set temperature (SV) within SV high limit [H - 5 u] to SV low limit [L - 5 u]. (※ L - 5 u > H - 5 u cannot be set.)
- When changing input type [i n - t], SV high limit [H - 5 u] and SV low limit [L - 5 u] of using temperature will be initialized as max./min.value of sensor temperature range automatically.

◎ Error

Display	Description	Troubleshooting
o P E n	Flashes if input sensor is disconnected or sensor is not connected.	Check input sensor state.
H H H H	Flashes if measured sensor input is higher than temperature range.	When input is within the rated temperature range, this display disappears.
L L L L	Flashes if measured sensor input is lower than temperature range.	

Economical PID Control

◎ Output connections

Refer to page H-142 for output.

● Application of relay output type

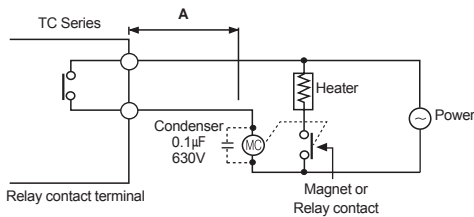

Keep **A** length as long as possible when wiring the temperature controller and the load. If wire length of **A** is short, counter electromotive force which occurs from a coil of magnet switch & power relay may flow in power line of the unit, and it may cause malfunction.

If wire length of **A** is short, please connect mylar condensers 104 (630V) on the both ends of "MC" (magnet coil) to protect electromotive force.

● Application of SSR drive output method

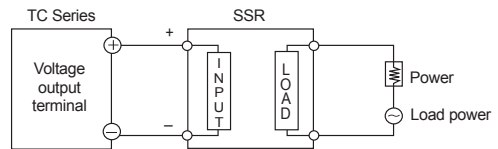

- ※SSR should be selected by the capacity of load, otherwise, it may short-circuit and result in a fire. Indirect heated should be used with SSR for efficient working.
- ※Please use a cooling plate or it may cause the capability deterioration, breakdown of SSR for a long usage.
- ※Refer to page H-63 for phase/cycle control connections.

■ Proper Usage

◎ Simple "error" diagnosis

● When the load (Heater etc) is not operated

Please check operation of the OUT indicator located in front panel of the unit.

If the OUT indicator does not operate, please check the parameter of all programmed mode.

If indicator is operating, please check the output (Relay, SSR drive voltage) after separating output line from the unit.

● When it displays $\square PE n$ during operation

This is a warning that external sensor is open.

Please turn off the power and check the wire state of the sensor. If sensor is not open disconnect sensor line from the unit and short the input +, - terminal. Turn on the power of the unit and check the controller displays room temperature.

If this unit cannot display room temperature, this unit is broken. Please remove this unit and contact our service center. (When the input mode is thermocouple, it is available to display room temperature.)

◎ Caution during use

- The connection wire of this unit should be separated from the power line and high voltage line in order to prevent from inductive noise.
- For crimp terminal, select following shaped terminal (M3)

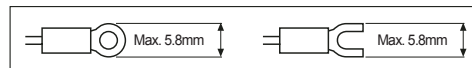

- Please install power switch or circuit-breaker in order to cut power supply off.
- The switch or circuit-breaker should be installed near by users.
- This unit is designed for temperature controlling only. Do not apply this unit as a voltage meter or a current meter.
- In case of using RTD sensor, 3-wire type must be used. If you need to extend the line, 3-wire must be used with the same thickness as the line. It might cause temperature difference if the resistance of line is different.
- In case of making power line and input signal line close, line filter for noise protection should be installed at power line and input signal line should be shielded.
- Keep away from the high frequency instruments. (High frequency welding machine & sewing machine, big capacitive SCR controller)
- When supplying measured input, if *HHHH* or *LLLL* is displayed, measured input may have problem. Turn off the power and check the line.
- This unit may be used in the following environments.
 - Indoor
 - Altitude: Under 2,000m
 - Pollution degree 2
 - Installation category II

Autonics