

## Area Sensor

### ■ Features

- Long sensing distance up to 7m
- 22 types of products  
(Optical axis: 20/40mm, Sensing height: 120 to 940mm)
- Minimizes unsensing area with 20mm optical axis pitch (BW20-□)
- Easy to recognize at side, front, and long-distance by high brightness LED of Emitter and Receiver
- Includes self-diagnosis function, mutual interference prevention function, external diagnosis function.
- Protection structure IP65 (IEC standard)

 Please read "Caution for your safety" in operation manual before using.



### ■ Specifications

Model	NPN open collector output (standard)	BW20-08 BW20-12 BW20-16	BW20-20 BW20-24 BW20-28	BW20-32 BW20-36 BW20-40	BW20-44 BW20-48	BW40-04 BW40-06 BW40-08	BW40-10 BW40-12 BW40-14	BW40-16 BW40-18 BW40-20	BW40-22 BW40-24	
	PNP open collector output	BW20-08P BW20-12P BW20-16P	BW20-20P BW20-24P BW20-28P	BW20-32P BW20-36P BW20-40P	BW20-44P BW20-48P	BW40-04P BW40-06P BW40-08P	BW40-10P BW40-12P BW40-14P	BW40-16P BW40-18P BW40-20P	BW40-22P BW40-24P	
Sensing type	Through-beam									
Sensing distance	0.1 to 7m									
Sensing target	Opaque materials of Min.Ø30mm					Opaque materials of Min.Ø50mm				
Optical axis pitch	20mm					40mm				
Number of optical axis	8 to 48EA					4 to 24EA				
Sensing width	140 to 940mm					120 to 920mm				
Power supply	12-24VDC ±10% (Ripple P-P: Max. 10%)									
Reverse polarity protection	Built-in									
Current consumption	Emitter: Max. 120mA, Receiver: Max. 120mA									
Control output	NPN or PNP open collector output • Load voltage: Max. 30VDC • Load current: Max. 100mA • Residual voltage - NPN: Max. 1V, PNP: Min. 2.5V									
Operation mode	Light ON (fixed)									
Short-circuit protection	Built-in									
Response time	Max. 10ms									
Light source	Infrared LED (850nm modulated)									
Synchronization type	Synchronized by synchronous line									
Self-diagnosis	Emitter/Receiver light circuit monitoring, Direct light monitoring, Output circuit monitoring									
Interference protection	Interference protection by master/slave function									
Environment	Ambient illumination	Ambient light : 100,000lx								
	Ambient temperature	-10 to 55°C, storage: -20 to 60°C								
	Ambient humidity	35 to 85%RH, storage: 35 to 85%RH								
Noise resistance	±240V the square wave noise (pulse width: 1µs) by the noise simulation									
Dielectric strength	1,000VAC 50/60Hz for 1minute									
Insulation resistance	Min. 20MΩ (at 500VDC megger)									
Vibration	1.5mm amplitude at frequency of 10 to 55Hz (for 1 min.) in each X, Y, Z direction for 2 hour									
Shock	500m/s <sup>2</sup> (approx. 50G) in each X, Y, Z direction for 3 times									
Protection structure	IP65 (IEC standard)									
Material	• Case: Aluminum • Cover, Sensing part: Acrylic									
Cable	Ø5mm, 4-core, length: 300mm, M12 connector									
Accessory	Bracket A: 4EA, Bracket B: 4EA, Fixing bolt: 8EA									
Approval										
Weight <sup>※1</sup>	Approx. 2.1kg(approx. 1.4kg) (BW20-48)					Approx. 2.1kg (approx. 1.4kg) (BW40-24)				

※1: The weight includes packaging. The weight in parentheses is for unit only.

※The temperature and humidity of environment resistance is rated at non-freezing or condensation.

**Autonics**

# BW Series

## Feature Data

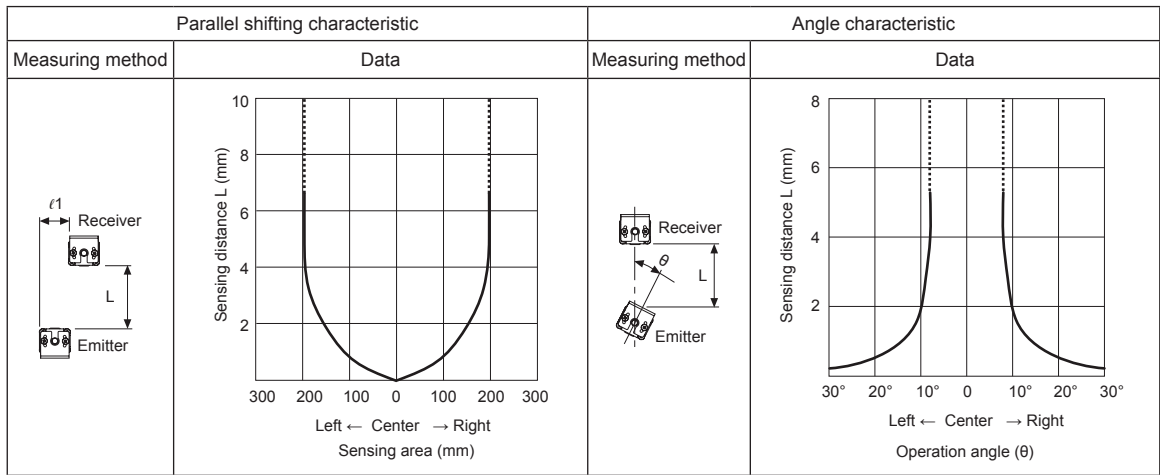

## Dimensions

(unit: mm)

<Emitter>    <Receiver>

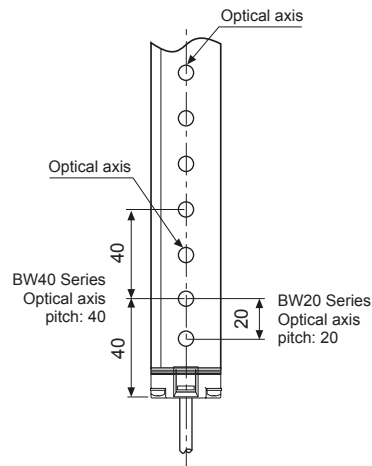
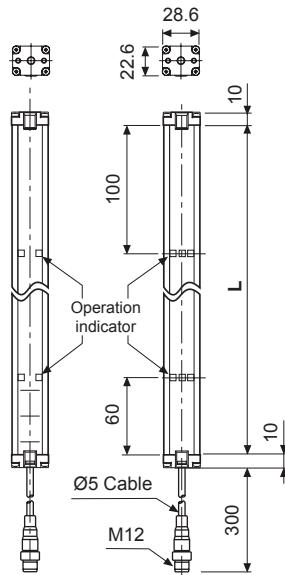

Model	L(mm)	Model	L(mm)
BW20-08(P)	160	BW20-32(P)	640
BW40-04(P)		BW40-16(P)	
BW20-12(P)	240	BW20-36(P)	720
BW40-06(P)		BW40-18(P)	
BW20-16(P)	320	BW20-40(P)	800
BW40-08(P)		BW40-20(P)	
BW20-20(P)	400	BW20-44(P)	880
BW40-10(P)		BW40-22(P)	
BW20-24(P)	480	BW20-48(P)	960
BW40-12(P)		BW40-24(P)	
BW20-28(P)	560		
BW40-14(P)			

### • Bracket A

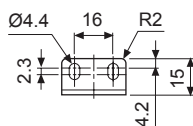
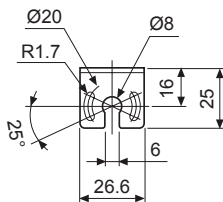

### • Bracket B

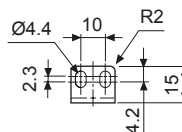
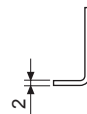
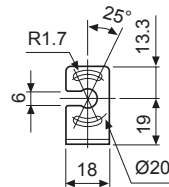

**Autonics**

## Control Output Diagram

### • NPN open collector output

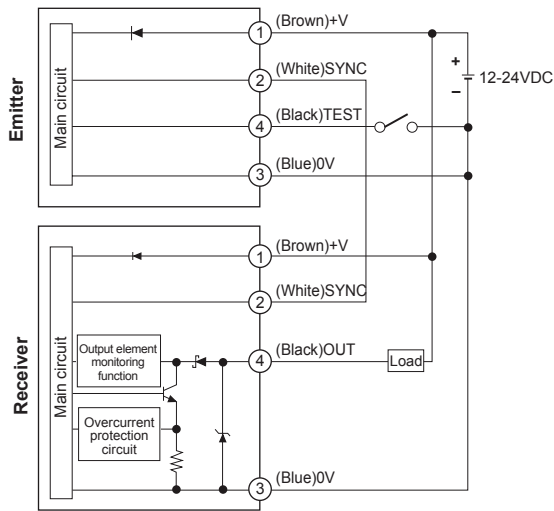

### • PNP open collector output

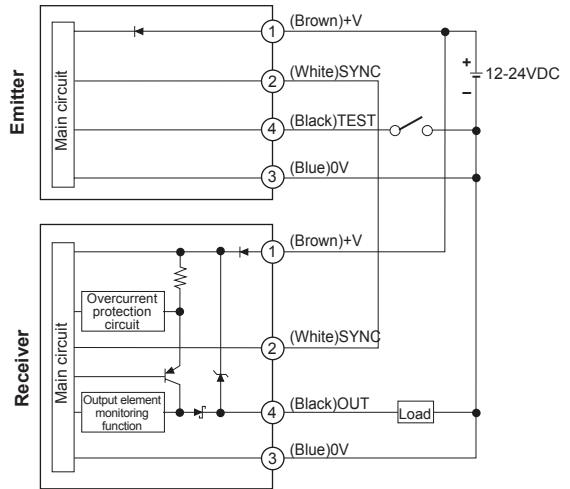

## Structure

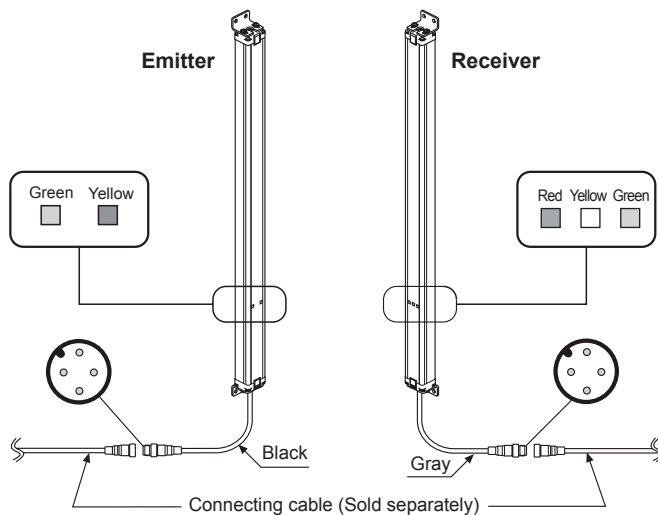

### <Operation indicator >

LED color	Emitter	Receiver
Green	POWER	ON
Yellow	TEST (M/S)	UNSTABLE
Red	—	OFF

### <Wiring Connection >

Pin No	Cable color	Emitter	Receiver
1	Brown	12-24VDC	12-24VDC
2	White	SYNC	SYNC
3	Blue	0V	0V
4	Black	TEST (M/S)	OUT

## Connecting Cable (Sold Separately)

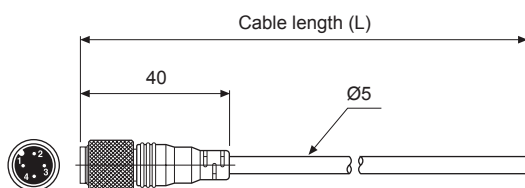

	Model	L	Cable color
Emitter	CID4-3T	3m	Black
	CID4-5T	5m	
	CID4-7T	7m	
	CID4-10T	10m	
Receiver	CID4-3R	3m	Gray
	CID4-5R	5m	
	CID4-7R	7m	
	CID4-10R	10m	

※Connecting cable is sold separately as one set; each of emitter's and receiver's.

**Autonics**

# BW Series

## Bracket Mounting

- Connect the bracket A

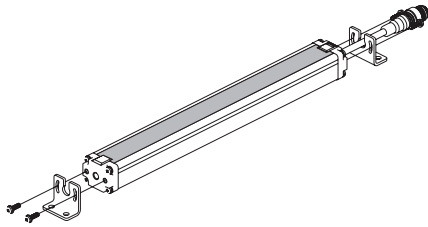

- Connect the bracket B

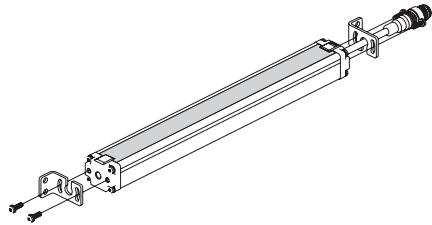

## Optical Axis Pitch/Number Of Optical Axis/Sensing Height

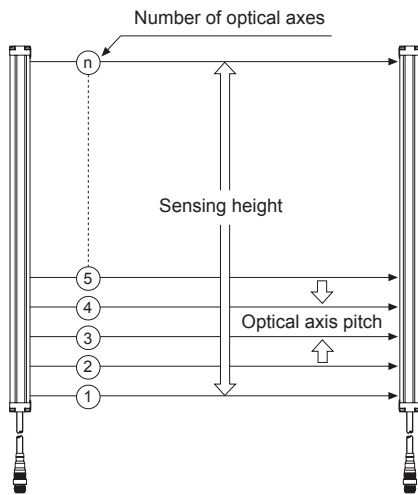

Model	Number of optical axes	Sensing height	Optical axis pitch	Model	Number of optical axes	Sensing height	Optical axis pitch
BW20-08(P)	8ea	140mm	20mm	BW40-04(P)	4ea	120mm	40mm
BW20-12(P)	12ea	220mm		BW40-06(P)	6ea	200mm	
BW20-16(P)	16ea	300mm		BW40-08(P)	8ea	280mm	
BW20-20(P)	20ea	380mm		BW40-10(P)	10ea	360mm	
BW20-24(P)	24ea	460mm		BW40-12(P)	12ea	440mm	
BW20-28(P)	28ea	540mm		BW40-14(P)	14ea	520mm	
BW20-32(P)	32ea	620mm		BW40-16(P)	16ea	600mm	
BW20-36(P)	36ea	700mm		BW40-18(P)	18ea	680mm	
BW20-40(P)	40ea	780mm		BW40-20(P)	20ea	760mm	
BW20-44(P)	44ea	860mm		BW40-22(P)	22ea	840mm	
BW20-48(P)	48ea	940mm	BW40-24(P)	24ea	920mm		

## Operation Timing Diagram

- Operation mode: Light ON only

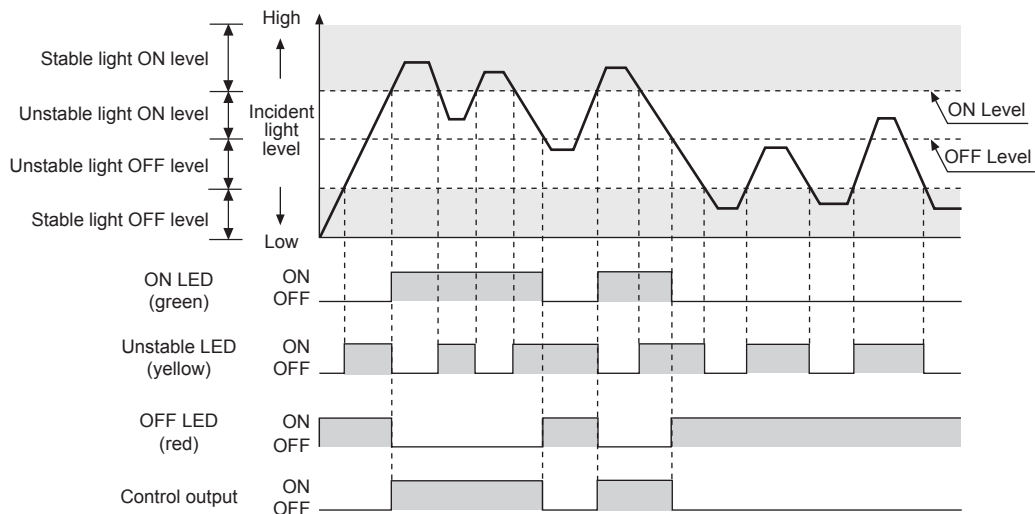

**Autonics**

## Function

### Light emitted stop (external diagnosis)

When TEST input (black) of emitter is 0V, emit is stopped and yellow LED of emitter flashes. It is available to check whether sensor operates properly with stopping the transmission when TEST input (black) of emitter is 0V. (It is changed to light OFF status when emit the transmission is stopped, control output of receiver is OFF.)

#### Connections for TEST input

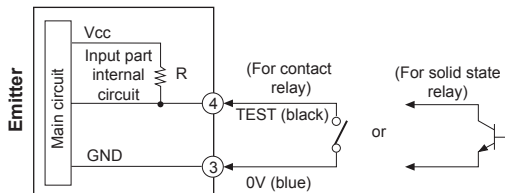

#### Control output pulse by TEST input

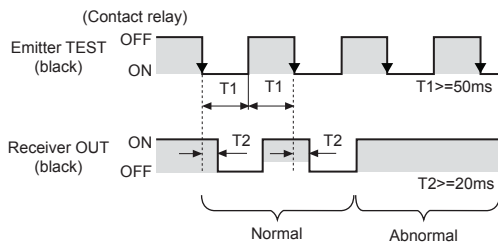

### Self-diagnosis

Control output will be OFF and operating indicator is ON when malfunction is checked by self-diagnosis regularly in normal operation.

#### Diagnosis items

- Emitter:
  - ① Break of light emitting element
  - ② Break of light emitter
  - ③ Malfunction of MASTER/SLAVE line (Operation in MASTER)
- Receiver:
  - ① Break of light receiver
  - ② Overcurrent at output part
  - ③ Synchronous line noise
- Refer to C-26, "Operation indicator" for the display operation of diagnosis.

### Interference protection

In case of using 2 sensors in parallel in order to extend sensing width, it may cause sensing error because as light interference.

This function is operating a sensor as MASTER and another sensor as SLAVE to avoid these sensing errors by the light interference.

#### Time chart for MASTER/SLAVE transmission pulse

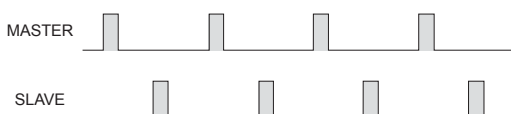

### MASTER/SLAVE connections

<NPN open collector output >

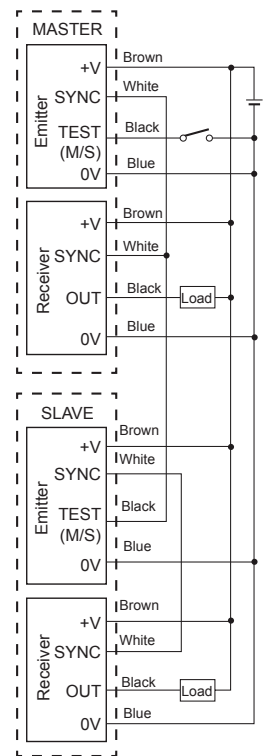

<PNP open collector output >

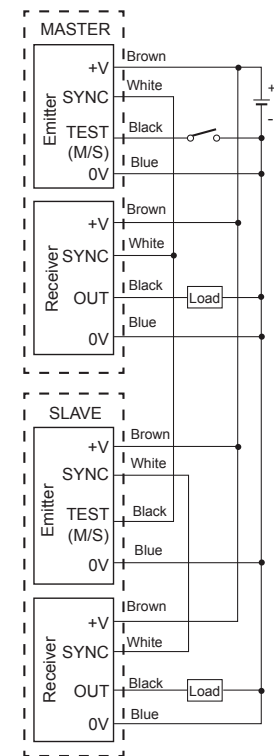

※Connect 'TEST (M/S)' of SLAVE emitter to 'SYNC' of MASTER.

## Installation

### For direction of installation

Emitter and receiver should be installed in same up/down direction.

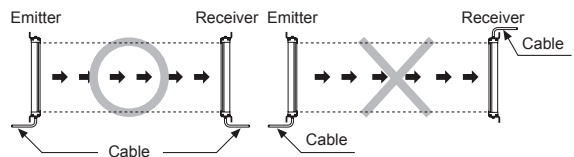

### For reflection from the surface of wall and flat

When installing it as below the light reflected from the surface of wall and flat will not be shaded. Please, check whether it operates normally or not with a sensing target before using. (Interval distance: Min. 0.5m)

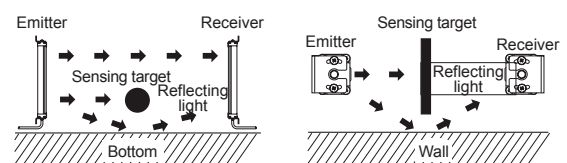

# BW Series

## ☉ For prevention of interference

It may cause interference when installing more than 2 sets of the sensor. In order to avoid the interference of the sensor, please install as following figures and use the interference protection function.

### • Transmission direction should be opposite between 2 sets

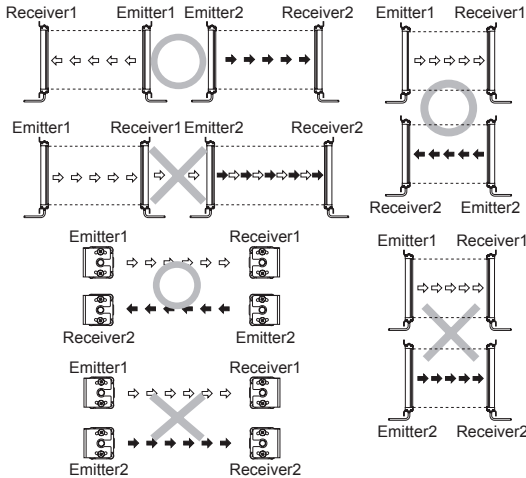

### • Baffle should be installed between 2 sets

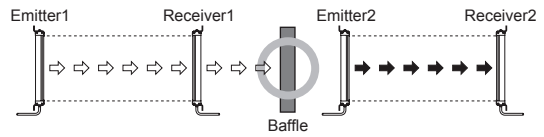

### • It should be installed out of the interference distance

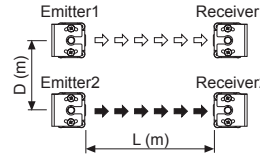

Sensing distance (L)	Installation allowable distance (D)
0.1 to 3m	Min. 0.4m
Min. 3m	$L \times \tan 8^\circ = L \times 0.14$ min

※ There can be a little different based on installation environment.

## ■ Operation Indicator

Item	Emitter		Receiver			Control output Light ON
	Indicator		Indicator			
	Green	Red	Green	Yellow	Red	
Power ON	☀	●	-	-	-	-
MASTER operation	☀	●	-	-	-	-
SLAVE operation	☀	☀	-	-	-	-
Test input	☀	●	-	-	-	-
Break of emitter	▶▶	◀◀	-	-	-	-
Break of light emitting element	▶	◀	▶	▶	▶	OFF
Install mode	Normal installation	●	☀	●	●	OFF
	Hysteresis installation	●	●	☀	●	OFF
	Abnormal installation	●	●	●	●	OFF
Stable light ON	-	-	☀	☀	●	ON
Unstable light ON	-	-	☀	☀	●	ON
Unstable dark ON	-	-	●	☀	☀	OFF
Stable dark ON	-	-	●	●	☀	OFF
Break of receiver	-	-	▶▶	◀◀	◀◀	OFF
Control output overcurrent	-	-	▶	◀	☀	OFF
Synchronous line noise	-	-	●	●	●	OFF
Emitter failure(Time out)	-	-	●	●	●	OFF

Display classification list	
☀	Light ON
●	Light OFF
◐ or ◑	Flashing by 0.5 sec.
◐◐ or ◑◑	Flashing simultaneously by 0.5 sec.
▶◀	Cross-Flashing by 0.5 sec.
▶▶	Sequence-Flashing by 0.5 sec.

## ■ Troubleshooting

Malfunction	Cause	Troubleshooting
Non-operation	Power supply	Supply rated power.
	Cable incorrect connection or disconnection	Check the wiring.
	Rated connection failure	Use it within rated sensing distance.
Non-operation in sometimes	Pollution by dirt of sensor cover	Remove dirt by soft brush or cloth.
	Connector connection failure	Check the assembled part of the connector.
Control output is OFF even though there is not a target object.	Out of rated sensing distance	Use within rated sensing distance.
	There is an obstacle to cut off the light emitted between emitter and receiver	Remove the obstacle.
	There is a strong electric wave or noise generated by motor, electric generator, high voltage line etc.)	Put away the strong electric wave or noise generator.
LED displays for break of light emitting element	Break of light emitting element	Contact our company.
LED displays for break of emitter	Break of light emitting circuit	
LED displays for break of receiver	Break of light emitting receiving element	
LED displays for synchronous line malfunction	Synchronous line incorrect connection or disconnection Break of synchronous circuit of emitter or receiver	Check the wiring. Contact our company.
LED displays for over current	Control output line is shorten Over load	Check the wiring. Check the rated load capacity.
LED displays for emitter malfunction	Emitter malfunction	Treat after checking the emitter display LED.