

MultiCONT





P-200

User's and Programming manual
software version v.02__

ООО “РусАвтоматизация”

454010 г. Челябинск, ул. Гагарина 5, оф. 507
тел. 8-800-775-09-57 (звонок бесплатный), +7(351)799-54-26, тел./факс +7(351)211-64-57
info@rusautomation.ru; русавтоматизация.рф; www.rusautomation.ru



CERTIFICATES		Reference document number
	BKI ATEX, Certificate No.: BKI11ATEX0017/2	prw2101m0600p_07
	BKI IECEX, Certificate No.: IECEX BKI 11.0004X Issue No.: 0	prw2101m0600p_03
<p>Segurança</p>  	INMETRO, Certificate No.: DNV 14.0170 X revisio 02	prw2101m0600p_03

CONTENTS

1. INTRODUCTION	6
1.1. THE HART® SYSTEM	7
1.1.1. Communication.....	7
1.1.2. System structure.....	7
1.1.2.1 Point-to-point connection.....	7
1.1.2.2 Multipoint connection (Multidrop). Multiple slaves connected in parallel.....	8
1.1.3. Properties of HART®-capable devices.....	8
1.1.4. The HART® Command set.....	9
1.1.4.1 Universal commands.....	9
1.1.4.2 General commands.....	10
1.1.4.3 Device-Specific commands.....	10
2. TECHNICAL DATA	11
2.1. ACCESSORIES	11
2.2. ADDITIONAL DATA FOR EXPLOSION-PROOF CERTIFIED VERSIONS	12
2.2.1. ATEX CERTIFICATE No.: BK111ATEX0017/2.....	12
2.2.2. IECEx CERTIFICATE No.: IECEx BK1 11.0004X ISSUE 0.....	12
2.2.3. INMETRO CERTIFICATE No.: DNV 14.0170 X REVISIO 02.....	12
3. ORDER CODES (NOT ALL COMBINATIONS ARE AVAILABLE!)	13
3.1. DIMENSIONS	14
3.2. EXPLOSION PROTECTION DATA	15
3.3. MAINTENANCE, REPAIR AND STORAGE CONDITIONS	15
4. ELECTRICAL CONNECTION	16
4.1. CABLE TERMINAL ARRANGEMENTS	16
4.1.1. Four relays version.....	16
4.1.2. Five relays version.....	16
4.2. WIRING	17
4.2.1. Transmitter wiring.....	17
4.2.1.1 Wiring of 2-wire units (transmitters).....	17
4.2.1.2 Wiring of Combined Systems (containing both 2- and 4-wire transmitters).....	17
4.2.2. Wiring of Universal Interface Modules (PJK-100).....	18
5. PROGRAMMING OF MULTICONT	18
5.1. PROGRAMMING STEPS	19
5.1.1. Scrolling and selecting menu items.....	20
5.1.2. Activating (of devices, relays and current outputs) items (of language, operation mode, etc.).....	20
5.1.3. Assigning Outputs (Relay and Current) to Devices.....	21
5.1.4. Entering Parameter Values.....	21
5.1.5. Editing Strings (e.g. Short TAG).....	22
5.2. COMMISSIONING A MultiCONT NETWORK	22
5.2.1. Preparation of the Transmitters and the Universal Interface Modules.....	23
5.2.1.1 Preparation of the Transmitters.....	23
5.2.1.2 Preparing the Universal Interface Modules.....	23
5.2.2. Wiring.....	23
5.2.3. Commissioning the MultiCONT.....	23
5.3. MAIN MENU	24
5.4. MULTICONT CONFIGURATION	25
5.4.1. DEV detect:.....	25
5.4.2. EXT detect:.....	28
5.4.3. Main Display:.....	28
5.4.3.1 Source.....	28
5.4.3.2 Rounding.....	28
5.4.3.3 Stepping.....	29
5.4.4. Value list.....	29
5.4.5. User Display:.....	29
5.4.5.1 Editing the user display.....	29
5.4.5.2 User Displays.....	29
5.4.6. HART.....	30
5.4.6.1 MultiCONT Short TAG.....	30
5.4.6.2 Polling Address.....	30
5.4.6.3 Message.....	30
5.4.6.4 Description.....	30
5.4.6.5 Date.....	30
5.4.6.6 Command Set.....	30
5.4.7. USER RS485.....	33
5.4.8. Data Logger.....	33
5.4.8.1 Trend logger.....	34
5.4.8.2 Time-window TOT (Total flow logging).....	35
5.4.8.3 Time-window FM (Flow Maximum logging).....	36
5.4.8.4 Using a memory card for logging.....	36
5.4.8.5 File system of the SD card and file content of a logging entry.....	37
5.4.9. Secret code.....	39
5.4.10. Language.....	39
5.4.11. Background lighting.....	39

5.4.12. Report.....	39	9.3.5 The unit does not start up when switched on	57
5.4.13. Prog CS.....	39	9.3.6 The „Response“ error entry is too frequent.....	57
5.5. PROGRAMMING THE DEVICES.....	40	9.4 ADDITIONAL INFORMATION	58
5.6. REMOTE PROGRAMMING.....	41	9.4.1 Problems that may occur during remote programming	58
5.6.1. Editing the linearisation table	42	9.4.2 MultiCONT transmits the parameters without examining them, and the testing is done by the device.....	58
5.7 RELAY CONFIGURATION.....	42	9.4.3 Use of Second HART Master (Hand-Held or HART modem + EView2 configuration software	58
5.7.1 Selecting relays.....	42	9.4.4 Upon exiting remote programming, the unit tests to see if the transmitter really exited the remote programming mode.....	58
5.7.2 Relay properties	43	9.4.5 When a transmitter does not respond, then „Response“ error is entered into the table, but upon termination of the error (the device responds), this entry is automatically cleared from the table (and does not need to be acknowledged).....	58
5.7.3 Relay programming.....	43	9.4.6 Upon exiting the menu, MultiCONT immediately saves the modifications.....	58
5.7.3.1 Source selection	43	9.4.7 The error list is cleared when the device is switched off	58
5.7.3.2 Function	43		
5.7.3.3 Configuring Parameters.....	48		
5.7.3.4 Inversion	48		
5.7.3.5 Deleting TOT	49		
5.7.3.6 Refreshing TOT.....	49		
5.7.3.7 Testing.....	49		
5.8 OPERATION AND PARAMETERS OF CURRENT OUTPUTS	50	Appendix 1 – Manufacturer id. codes of HART compatible devices.....	59
5.8.1 Selection of current outputs	50	Appendix 2. – The menu system of the MultiCONT p-200.....	61-62
5.8.2 Properties of the selected current output	50	Appendix 3. – Relay programming	63
5.8.3 Current output programming	51	Appendix 4. – Current output programming.....	63
5.8.3.1 Source Selection.....	51	Appendix 5. – Measurement mode	64
5.8.3.2 Function	51	THERMOPOINT TMH-500 logging.....	64
5.8.3.3 Parameter Configuration	51		
5.8.3.4 Testing	51		
5.9 THE BOOT PROCESS.....	52		
5.10 MEASUREMENT MODES	52		
5.11 MULTICONT SAVING AND LOADING SETTINGS	53		
6. ERROR CODES.....	53		
7. HARDWARE PROTECTION OF SETTINGS	54		
8. FUSE REPLACEMENT.....	54		
9. SERVICING.....	55		
9.1 BOX MESSAGES	55		
9.2 OTHER MESSAGES.....	56		
9.3 TROUBLESHOOTING	57		
9.3.1 It is impossible to enter the „Main menu“/„Relays“ or „Main menu“/„Current outputs“ menu	57		
9.3.2 It is impossible to enter the „Main menu“/„Devices“ menu	57		
9.3.3 A „Please wait“ message appears upon selecting „DEV detect“.....	57		
9.3.4 The result of „DEV detect“ is the „No device“ message	57		

1. INTRODUCTION

The **MultiCONT** unit is a universal interface between **NIVELCO**'s HART-capable intelligent level transmitters and other elements of the process control system such as PCs, PLCs, displays and actuators. Besides its role as an interface, the **MultiCONT** provides power for the 2-wire transmitters, and it is capable of handling complex control tasks. The **MultiCONT** unit supports communication with a maximum of 15 standard or 4 Ex certified **NIVELCO**'s HART-capable 2 and / or 4-wire transmitters. If the **MultiCONT** is used with **NIVELCO**'s **MicroTREK** microwave level transmitters, the maximum number of transmitters in a loop should not exceed 8 for normal transmitters and 2 for Ex version transmitters. The maximum number of **PiloTREK** transmitters in a loop should not exceed 6 for normal devices and 2 for Ex version* transmitters. If a system contains one too many transmitters the **MultiCONT** can handle, further **MultiCONT** units can be wired in series via RS485.

The **MultiCONT** is capable of programming transmitters remotely and downloading parameters and measured data. The outputs such as 4...20 mA, relays, and digital outputs can be controlled using measured values and derived values calculated from them. Measured values (Primary Value and three additional values) can be logged.

A large dot-matrix LCD panel provides a wide variety of functions, including tank content visualization. The type and number of outputs of the base unit can be expanded with external (relay and/or current loop output) PJK-100 type universal interface modules. The total number of relays connected to the **MultiCONT** and the modules must not exceed 64, and the number of analog outputs (4...20 mA outputs) can be 16, maximum. A further restriction is that there can be a maximum of 32 universal interface modules.

** Certified explosion-proof versions of the MultiCONT are available for hazardous environments.*

1.1. THE HART® SYSTEM

The HART® (Highway Addressable Remote Transducer – bus addressable field devices) is a digital communication protocol developed for industrial measurement applications. A short amplitude digital signal is transmitted via the widely used standard 4...20 mA output. Due to its symmetric sinusoidal nature and its short amplitude, it does not affect the output current's accuracy. Since HART modulates the sensor's signal, no extra cable is needed for HART signal transmission.

Identifying, programming, and querying transmitters is performed via HART.

The diagram on the right shows the output signal of a 4...20 mA transmitter (device) and the superimposed HART signal, which is essentially a ± 0.5 mA modulation of the output current.

The enlarged picture shows that HART communication uses frequency modulation, and logical "1" is assigned to 1200 Hz, while "0" is assigned to 2200 Hz. This is called FSK (Frequency-Shift Keying) modulation.

The communication is realized with systematic series of impulses above described.

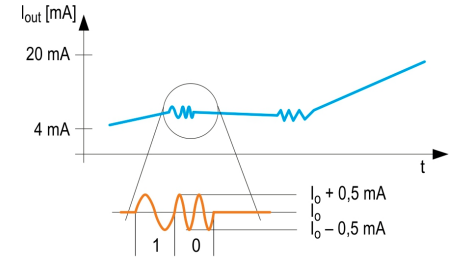

1.1.1. Communication

HART communication is a master-slave setup, which means that the transmitter – slave – only sends a response when the master (of which there can be only one in the system) sends a query. The master can be a Hand-held Communicator, a PC with a HART modem or a universal interface, or a MultiCONT (only one can be active). Communication uses standard commands (see chapter 1.1.3)

1.1.2. System structure

The system must contain a 230..1000 Ω resistor to guarantee that the short amplitude HART signal will not load the power supply with an unknown output impedance.

1.1.2.1 Point-to-point connection

When a master (communicator or HART modem with PC or MultiCONT) and a slave are alone in a system, we talk of a point-to-point connection.

The transfer speed is 1200 bit/sec, communication is slow, because the master queries and the slave respond. The speed can be increased if the querying is left out, and the slave responds continuously every given period of time until the master stops the transfer in the break between 2 data transmissions. This is called "burst mode."

In this case the flowing current is the output current of the transmitters, so if permitted by the loop voltage, even a local indicator can be hooked up to the loop. Essentially, the minimal voltage specified in the manual must be kept on the terminals of the transmitters.

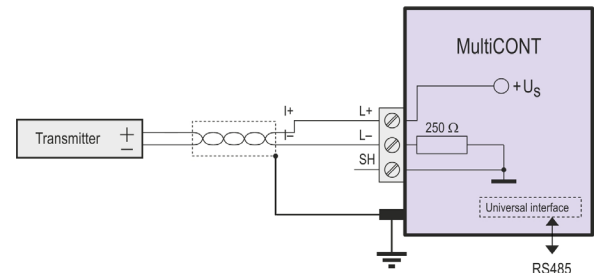

1.1.2.2 Multipoint connection (Multidrop). Multiple slaves connected in parallel

HART's addressing system can handle 15 devices whereby they are wired in parallel. In this case, the current is the sum of the currents of all the devices in the loop, which has no informative value. So, in this case, the output current of the transmitters must be set to multidrop mode, which means a constant current of 4mA. This happens automatically when the polling address is set between 1...15. (if the polling address is 0, then there must be only one transmitter with 4...20 mA output, if the polling address is 1...15, then there will be a constant 4 mA current). There is a deviation possibility for transmitters whose output current can be programmed to an arbitrary fixed value, however in this case, the minimal voltage drop on the terminal of the transmitters must be the minimum specified voltage, otherwise the transmitter(s) will not work (measure or respond) In a multidrop system, the "burst mode" does not work.

* An 820 Ω resistor must be connected between the L- and SH terminals of the Ex-version MultiCONT when it is used with the 3 (max. allowed) Ex version MicroTREK microwave level transmitter.

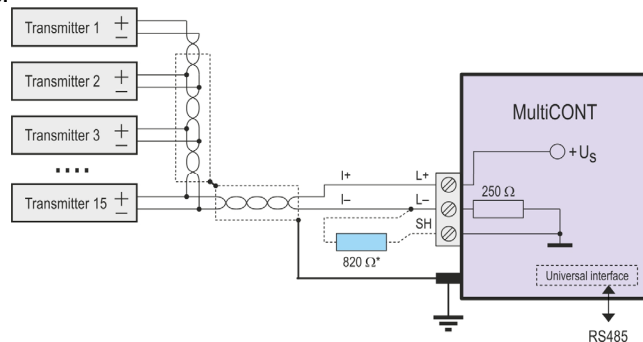

1.1.3. Properties of HART®-capable devices

These parameters are programmed into the unit in the factory. Some of them can be edited by the user with a HART MASTER; the rest can only be edited by the manufacturer.

Short TAG:	An 8-character editable device ID.
Short address:	Used to differentiate between up to 15 devices. Short address is unique for each device in the system. It is editable.
Message:	An editable 32-character long arbitrary comment that can be assigned to the device and is operation-related.
Descriptor:	An editable 16-character long arbitrary comment that can be assigned to the device and is material-related.
Date:	Date. It can be assigned to the device. It is editable.
Factory ID:	Factory ID. For NIVELCO devices: 151, not editable.
Device type ID:	Device type ID, not editable.
Device ID:	The manufacturer's electronic production number, not editable. The Factory ID, the Device Type ID and the Device ID together constitute the "Long Address."
SW (Software) revision:	Software version of the device (see device manual).
HW (Hardware) revision:	Hardware version of the device (see device manual).

An additional parameter contains the version number of the HART command set used by the device.

1.1.4. The HART® Command set

Using HART® commands, we can decide what the devices should do. An ultrasonic transmitter needs different commands than a temperature transmitter or a valve, that would mean a lot of different commands. To avoid too much traffic, every command has a one-byte identifier that corresponds to a preprogrammed command specific to that particular device. Command 31 is the Extended ID, which makes the next 2 bytes a part of the command ID (0...65535). HART commands are divided in to 3 classes:

- universal commands 0...30
- general commands 32...121
- device-specific commands 128...253

All commands contain an address (short address, long address, or TAG), which determines the corresponding device.

All connected devices must have a unique address!

1.1.4.1 Universal commands

These commands are understood by all devices, to which they give the same response.

0. *Read Unique Identifier*

the addressed device provides the following in it's reply:

- Manufacturer's code (provided by the HART foundation, see appendix)
- Product code (provided by manufacturer, see chapter 5.2.1.1)
- Universal command table code (HART 5)
- Device ID
- Software version
- Hardware version
- Device status

1. *Read Primary Variable*

This reads the digital value (Primary Value) that the transmitter sends to the 4...20 mA output. The numeric value contains the dimension (unit) as well.

2. *Read Output Current in mA and in Percent of Range*

3. *Read Output Current and Four Dynamic Variables*

The primary, secondary, tertiary and quaternary variables are transmitted. The secondary, tertiary, and quaternary variables are specified in the manual of the particular devices.

6. *Modify (short) Polling Address (Write Polling Address)*

If there is more than one device in the loop (multidrop), each device must have a different address.

Addresses should be configured before connecting the devices to avoid errors caused by devices with the same addresses replying at the same time.

11. *Read Unique Device Identifier Associated with Tag*

Devices are queried by their short TAG, not their addresses.

Therefore, all short TAGs must be unique within the system.

12. *Read Device Message*
This reads the 32-character message stored in the non-volatile memory of the device (e.g., T18 35% HCL TANK)
13. *Read the 8-Character "Short TAG", 16-Character Descriptor and Date*
14. *Read PV Sensor Information*
15. *Read Output Information*
16. *Read Final Assembly Number*
17. *Write 32-Character Message*
18. *Write 8-Character "Short TAG", 16-Character Descriptor and Date*
19. *Write Final Assembly Number*

1.1.4.2 General commands

These commands do not have to be understood by all devices. If the device does not understand a command, it is ignoring, however, if the command is understood, it must be interpreted according to the standard. There are numerous such commands; the most important ones are the following:

- 34: Damping (writing settling time)
- 35: Measurement range (writing of upper and lower limits, and/or dimension)
- 36: Upper limit now! (sets the upper limit – 20 mA)
- 37: Lower limit now! (sets the lower limit – 4 mA)
- 40: Setting constant current output (useful during testing)
- 41: Device self-test, sends back the result
- 42: Master reset (restoring factory default)
- 50: Reading assignment status of the primary variable (PV), the secondary variable (SV), the tertiary variable (TV) and the quaternary variable (QV). This cannot always be read unambiguously; in most cases it can be found in the manual of the device.
- 109: Switching „Burst“ mode on and off

1.1.4.3 Device-Specific commands

These commands are specified by the manufacturer. The commands are described in the device manual.

2. TECHNICAL DATA

TYPE		P□□-2□□-□
Outputs	Transmitter Power Supply	30 VDC / 60 mA (For Ex Version: 25 VDC / 22 mA)
	Display	128 x 64 dot-matrix LCD, or OLED display
	Analogue	Max. 2 galvanically isolated 4...20 mA outputs, max load of 500 Ω, with over-voltage protection
	Relay	Max. 5 SPDT, 250 V AC, AC1. 5 A
	RS485 interface	Galvanically isolated, HART®/Modbus protocol
	HART®	Output signal level: 0.5 ±0.1 V _{pp} trapezoid 1200 / 2200 Hz Minimum level of Input signal: 50 mV _{pp} Inbuilt sensor resistance: 250 Ω
	LOGGER	Capacity: FLASH = 65000 entry; SD card (max 32 GB) = depends on the card!
Connecting cables	Power Supply, Relays, analogue 4...20 mA	0.5...2.5 mm ² (AWG20 – AWG14) wire cross-section
	RS485 interface	Shielded, twisted cable pair with a cross section of 0.5...2.5 mm ² (AWG20 – AWG14)
	HART line	Below 1500 m (4 920 feet) shielded, twisted cable pair with a min. cross section of ∅0.5mm (∅0.02 inch) Above 1500 m (4 920 feet) shielded, twisted cable pair, with a min. cross section of ∅0.8mm (∅0.03 inch) max. resistance : 75 Ω, max. capacitance : 200 nF
Number of powered transmitters		Max. 15 non-Ex (max. 4 Ex) transmitters
Power Supply / Power Consumption / Max. Power Supply		85...255 VAC 50...60 Hz / 12 VA / 255 V _{eff} 11.4...28 VAC 50...60 Hz / 12 VA / 28 V _{eff} 11.4...40 VDC / 11 W / 40 VDC
Fuse		85...255 VAC 50...60 Hz T400 mA 11.4...28 VAC 50...60 Hz and 11.4...40 VDC T1A
Fuse		Polycarbonate (PC)
Mounting		Wall mounted
Ambient temperature	P□□, P□W	-20°C...+50°C (-4°F...+122°F)
Ingress protection		IP65, (except P□A-2□□-□, IP20)
Electrical protection		Class I. / III.
Weight		0.9 kg (2 lbs)



In the case of OLED, the lifetime of the display depends on the way the user applies the screen saver function and hence it is not covered by the warranty.

2.1. ACCESSORIES

- Warranty Card
- User's and Programming manual
- EU Declaration of Conformity
- 2 universal cable gland sealings

2.2. ADDITIONAL DATA FOR EXPLOSION-PROOF CERTIFIED VERSIONS

2.2.1. ATEX CERTIFICATE No.: BK111ATEX0017/2

TYPE	MultiCONT P□□-2□□-5,6Ex
Ex marking (ATEX)	 II (1) G [Ex ia Ga] IIB,  II (1) D [Ex ia Da] IIIC $T_{amb} = -20^{\circ}\text{C} \dots +50^{\circ}\text{C} (-4^{\circ}\text{F} \dots +122^{\circ}\text{F})$
Ex power supply, loading	$U_0 = 30\text{ V}$ $I_0 = 140\text{ mA}$ $P_0 = 1\text{ W}$ $L_0 = 4\text{ mH}$ $C_0 = 200\text{ nF}$ $U_m = 253\text{ V}$

2.2.2. IECEx CERTIFICATE No.: IECEx BK1 11.0004X ISSUE 0

TYPE	MultiCONT P□□-2□□-5,6Ex
Ex marking (IECEx)	[Ex ia Ga] IIB, $-20^{\circ}\text{C} (-4^{\circ}\text{F}) \leq T_{amb} \leq +50^{\circ}\text{C} (+122^{\circ}\text{F})$
Ex power supply, loading	$U_0 = 30\text{ V}$ $I_0 = 140\text{ mA}$ $P_0 = 1\text{ W}$ $L_0 = 4\text{ mH}$ $C_0 = 200\text{ nF}$ $U_m = 253\text{ V}$

2.2.3. INMETRO CERTIFICATE No.:DNV 14.0170 X REVISIO 02

TYPE	MultiCONT P□□-2□□-5,6Ex
Ex marking (INMETRO)	[Ex ia Ga] IIB, $-20^{\circ}\text{C} (-4^{\circ}\text{F}) \leq T_{amb} \leq +50^{\circ}\text{C} (+122^{\circ}\text{F})$ IP65
Ex power supply, loading	$U_0 = 30\text{ V}$ $I_0 = 140\text{ mA}$ $P_0 = 1\text{ W}$ $L_0 = 4\text{ mH}$ $C_0 = 200\text{ nF}$ $U_m = 253\text{ V}$

3. ORDER CODES (NOT ALL COMBINATIONS ARE AVAILABLE!)

MultiCONT P - 2 -

TYPE	CODE	VERSION / DISPLAY	CODE	INPUT	CODE	OUTPUT	CODE	POWER SUPPLY / CERTIFICATES	CODE
Expandable*	R	IP65 Enclosure / LCD	W	Single-channel for one unit	1	Display only	0	85...255 V AC	1
Standard	E	IP20 Enclosure / logger / LCD	A	2 channels for up to 2 units	2	1 relay	1	24 V AC/DC	2
		IP65 Enclosure + transparent cover / LCD	C	4 channels for up to 4 units	4	2 relays	2	85...255 V AC / Ex	5
		IP65 Enclosure + transparent cover / logger / LCD	D	8 channels for up to 8 units	8	3 relays	3	24 VAC/DC / Ex	6
		IP65 Enclosure / OLED	L	15 channels for up to 15 units	M	4 relays	4		
		IP65 Enclosure + transparent cover / OLED	K			5 relays	D		
		IP65 Enclosure + transparent cover / logger / OLED	N			1x 4...20 mA current output	F		
						1 relay + 1x 4...20 mA current output	5		
						2 relays + 1x 4...20 mA current output	6		
						3 relays + 1x 4...20 mA current output	7		
						4 relays + 1x 4...20 mA current output	8		
						5 relays + 1x 4...20 mA current output	Q		
						2x 4...20 mA current output	G		
						1 relay + 2x 4...20 mA current output	H		
						2 relays + 2x 4...20 mA current output	J		
						3 relays + 2x 4...20 mA current output	K		
						4 relays + 2x 4...20 mA current output	9		
						RS485 interface	A		
						1 relay + RS485 interface	L		
						2 relays + RS485 interface	M		
						3 relays + RS485 interface	N		
						4 relays + RS485 interface	P		
						5 relays + RS485 interface	E		
						1x 4...20 mA current output and RS485 interface	B		
						1 relay + 1x 4...20 mA output + RS485 interface	R		
						2 relays + 1x 4...20 mA output + RS485 interface	C		
						3 relays + 1x 4...20 mA output + RS485 interface	S		
						4 relays + 1x 4...20 mA output + RS485 interface	T		
						5 relays + 1x 4...20 mA output + RS485 interface	Z		
						2x 4...20 mA current output + RS485 interface	U		
						1 relay + 2x 4...20 mA output + RS485 interface	V		
						2 relays + 2x 4...20 mA output + RS485 interface	W		
						3 relays + 2x 4...20 mA output + RS485 interface	X		
						4 relays + 2x 4...20 mA output + RS485 interface	Y		

Ex: Ex ia

The order code of an Ex-version should end in „Ex“.

* The system can be expanded using Relay, Analogue and Universal Interface Modules.

3.1. DIMENSIONS

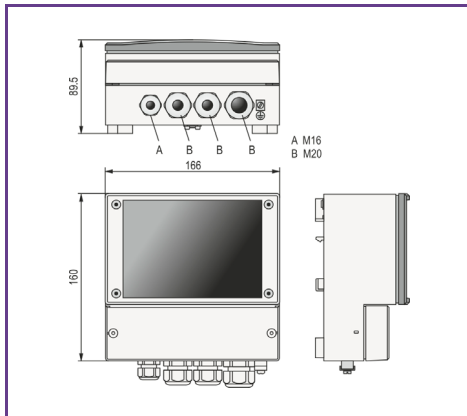

POW

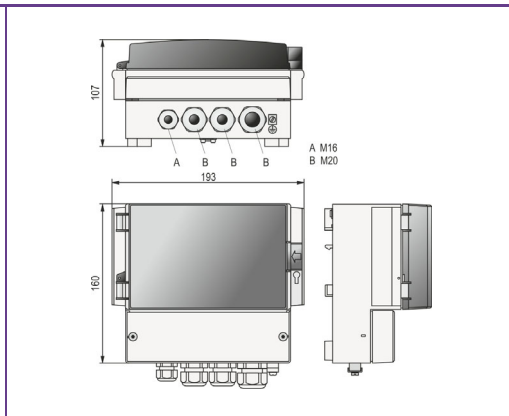

POC, POD

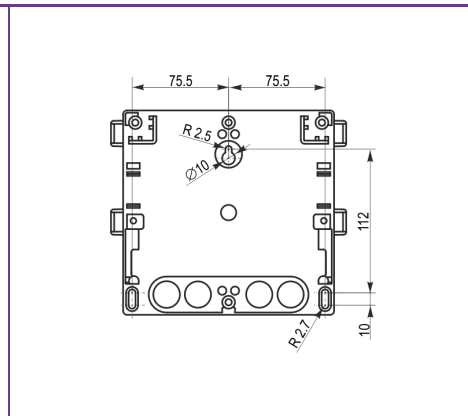

ARRANGEMENT OF MOUNTING HOLES

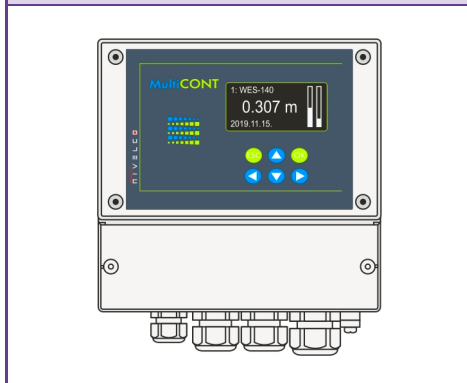

POW

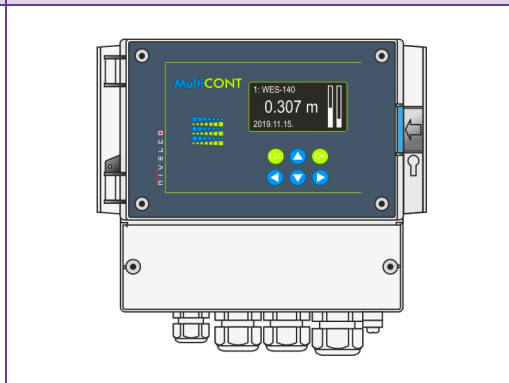

POC

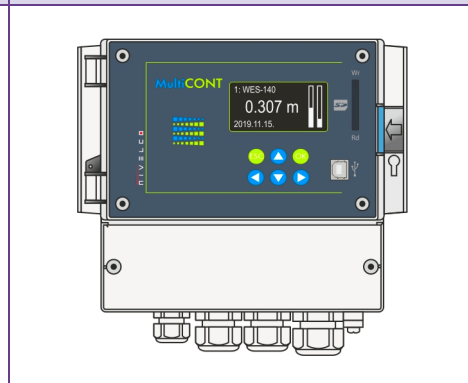

POD

3.2. EXPLOSION PROTECTION DATA

- The units must be mounted outside the hazardous zone
- Devices must be protected from direct sunshine
- Power supply and ambient temperature values must not exceed specified values
- Transmitters installed in hazardous areas must be connected to the L+ and L- terminals only
- The housing of the transmitters must be grounded
- Transmitters must be connected using shielded, twisted cables

3.3. MAINTENANCE, REPAIR AND STORAGE CONDITIONS

The device does not require regular maintenance. The warranty card contains the terms and conditions.

Before returning the device for repairs, it must be cleaned thoroughly. The parts in contact with the medium may contain harmful substances; therefore, they must be decontaminated. The device must be sent back with a declaration of decontamination. A statement must be provided in the declaration that the decontamination process was successfully completed and that the device is clean from any hazardous substances.

Unused devices must be stored within the ambient temperature range specified in the technical data, with a maximum of 98% relative humidity.

4. ELECTRICAL CONNECTION

4.1. CABLE TERMINAL ARRANGEMENTS

4.1.1. Four relays version

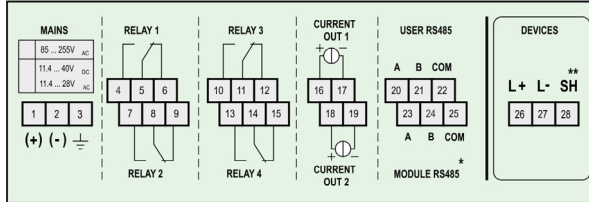

4.1.2. Five relays version

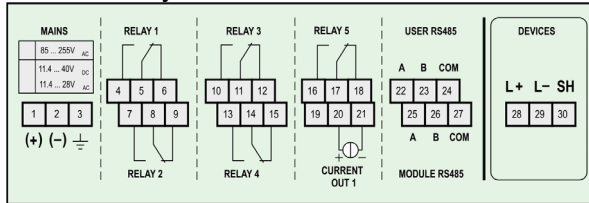

After removing the screws of the cover, cables can be connected. Use the appropriate wires for AC, DC, SELV, and mains.

Use shielded and twisted cables (STP) to connect the transmitters. Wire length depends on the number of connected units and the electrical properties of the cable.

RS485 interface:

- A:** TRD +
- B:** TRD -
- COM:** shielding

* Only PR types

** Non-Ex versions only

Number of Transmitters	Cable Capacitance (pF / m)			
	65	95	160	225
1	2800	2000	1300	1000
5	2500	1800	1100	900
10	2200	1600	1000	800
15	1850	1400	900	700

Shielding of the connecting cable between the transmitter and the controller should be grounded at one end, connected either to the internal or external part of the grounding screw.

Intrinsically safe (Ex) transmitters should be connected to the L+, L- terminals of the controller. These points are galvanically isolated from the rest of the electronics. Output current and voltage are limited.

4.2. WIRING

4.2.1. Transmitter wiring

Before wiring, please check if the units (order codes) are HART compatible, the value of the loop current and also if there are two or more units with the same “Short address” (see 5.2. Steps of commissioning).

4.2.1.1 Wiring of 2-wire units (transmitters)

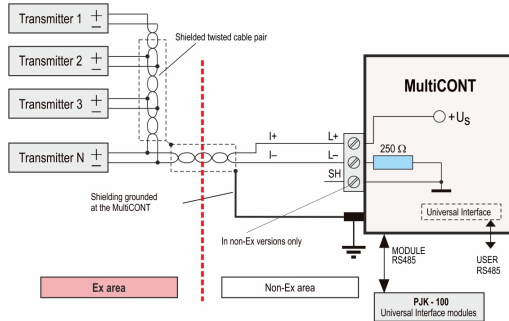

4.2.1.2 Wiring of 4-wire units (transmitters with separate power supply)

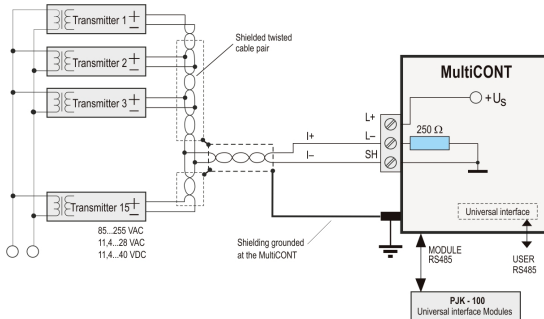

4.2.1.2 Wiring of Combined Systems (containing both 2- and 4-wire transmitters)

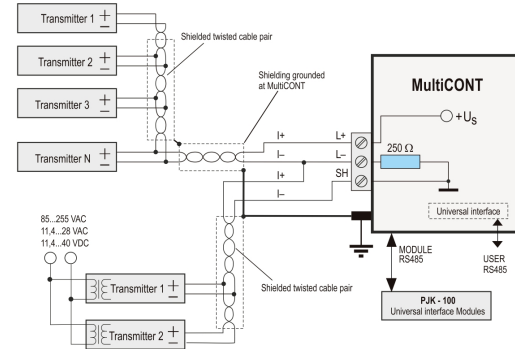

4.2.2. Wiring of Universal Interface Modules (PJK-100)

Connection with shielded twisted pair cable, shielding is grounded at one point, at the MultiCONT.

The terminal resistor is connected to the two farthest points of the cable. (TB and B terminals are connected in PJK 100; and on the MultiCONT the K2 terminal resistor, located next to the terminals, is switched on.)

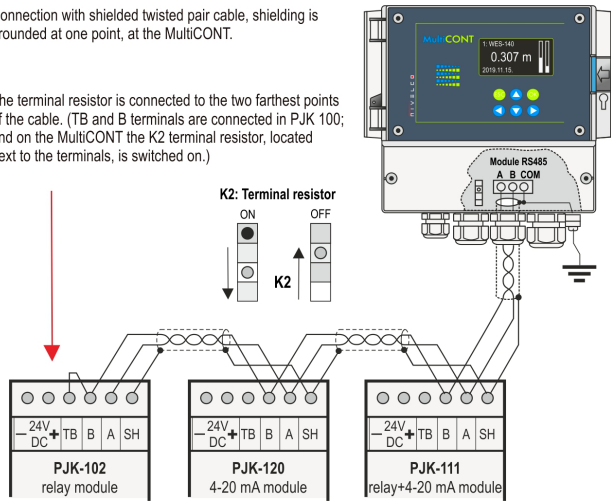

The most important rule is that the data transfer line has to be closed on both ends with a resistor, at points farthest from each other. The value of the termination resistor depends on the wave impedance of the connecting cable. The interface contains a 120 Ω terminal resistor, so please use a cable with appropriate impedance.

If the number of termination resistors is not 2, or the 2 termination resistors are not at the farthest points from each other, the system will malfunction. Especially if the data transfer cable is too long, data transfer errors are likely to occur.

The universal interface modules must be connected one after another on one cable pair. Star topology is forbidden. The maximum length of the cable is 1000 m, but in this case a cable with shielded, twisted pair of wires (STP, Shielded Twisted Pair) must be used. The capacitance of the cable must be less than 100 pF/m. The universal interface modules connected to the system must each be given different addresses (0...31), see 5.2.1.2.

5. PROGRAMMING OF MULTICONT

The following actions can be performed:

- Automatic detection of devices (transmitters) connected to the MULTICONT and adding them to the list of devices. Devices not on the list might be connected to the system but are unable to communicate with the MULTICONT (see 5.2.3 Main menu / MULTICONT config / DEV detect).
- Activating and deactivating devices (transmitters) (See 5.2.3 Main menu / Devices). Theoretically, all devices in the system are working, whether they are listed or not. Devices in the list are automatically activated. Deactivation disables devices temporarily.
- Activating and deactivating relays and current outputs (see Appendices 3 and 4).
- Relays and current outputs of the MULTICONT are activated the same way devices are (see Appendices 3 and 4).
- Assigning MULTICONT outputs (relays, current outputs) to devices (transmitters).
- Formulating functional values (difference of 2 measured values, sum or average of 2 or more measured values).
- Remote programming of devices. (Parameters of the transmitters e.g., P01, P02, etc. are used in this manual the same way as described in the Installation and User's Manual)
- Programming of MULTICONT outputs. (Relay and current output parameters of the MULTICONT are identified as RP1, RP2, RP3 and CR1, CR2, CR3 respectively).

Sound knowledge of HART standards and programming of the connected devices is required for configuring systems involving the MultiCONT universal interface.



Programming on the fly can be performed without halting the system. Modifications will be saved automatically upon returning to measurement mode.

If the MultiCONT is left in Programming mode, it will automatically return to Measurement mode 5 minutes after the last key was pressed (modifications will be saved).

In case of one or multiple devices when the relay settings are modified use the 'Load default settings' if necessary!



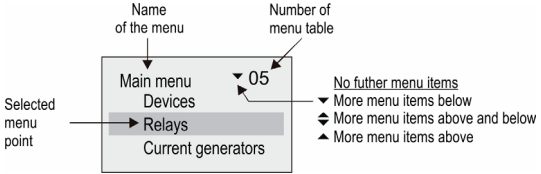

5.1. PROGRAMMING STEPS



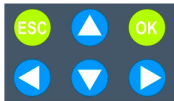

Programming is done via the six buttons with the help of the 128x64 point graphic screen. There are three different kinds of screens on the display

<ul style="list-style-type: none"> • Measurement / operation Screens (marked with capital letters in the upper right corner, see Appendix 5): Measurement, see 5.10 Measurement Mode Bar graph (output range) User, see 5.4 MULTICONT Configuration Relay assignment table Current output assignment table Error list, see 6. Error Codes 	<ul style="list-style-type: none"> • Programming / Configuration Screens: 
<ul style="list-style-type: none"> • Box messages / warnings indicate steps taken by the unit or those to be performed 	



Below is a brief summary of programming; the complete menu system is detailed in Appendix 2. The current menu item and the editable value or character is highlighted at the cursor.







Use  and  to navigate in the menu. Pressing and holding the buttons will cycle through the menu continuously
To select a menu item, press  and press  to exit.

The  and  buttons move the cursor in editable fields and cycle through values (numbers or text) when editing parameters. The  and  scroll cycle through characters when editing parameters (when held, these buttons move the cursor continuously, wrapped around). Use  close error messages (it deletes them from the error list).

5.1.1. Scrolling and selecting menu items

To cycle through various modes (M, B, U, R, C, E) use the  and  buttons.

Use the  button to enter into the menu item at the cursor, and use the  button to exit.

Use the  and  buttons to navigate between items (when held, these buttons move the cursor continuously, wrapped around).

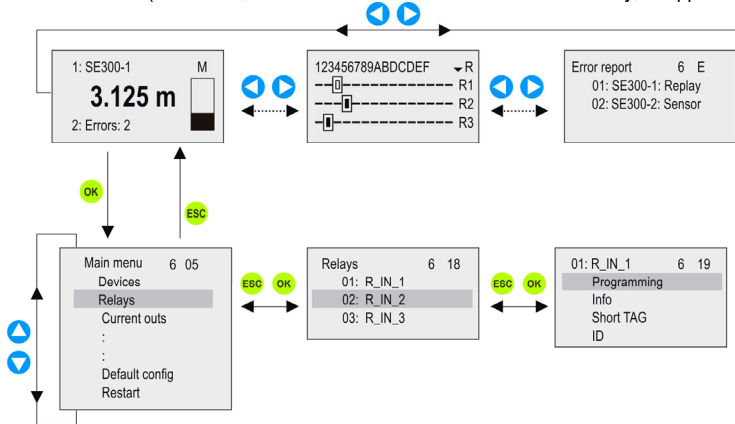

5.1.2. Activating (of devices, relays and current outputs) items (of language, operation mode, etc.)

Devices on the list may be active () or inactive (). Only active devices will be queried. Active relays and current outputs operate as they are configured, inactive relays are disengaged, and current outputs are 0 mA, while inactive

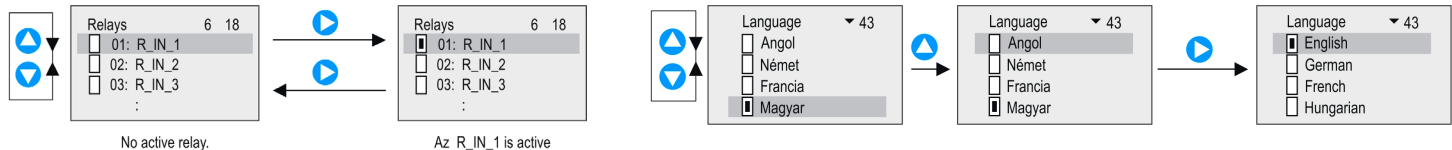

Use  to activate / deactivate relays.

Selecting various modes (relay modes, current output modes, languages, etc.) is done in a similar fashion.

The selected language is activated immediately.

5.1.3. Assigning Outputs (Relay and Current) to Devices

When setting up relays and outputs, they have to be assigned to devices and their variables (PV, SV, TV, QV):

- Value is positive (add)
- Value is negative (difference measurement)
- Values marked this way are used for average calculation

The above settings can be changed using

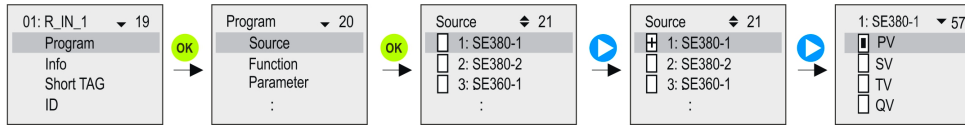

Assignment of device **SE380-1** to the relay **R_IN_1** in the MultiCONT is performed as shown below.

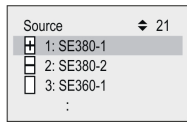

Relay R_IN_1 is controlled by the **difference** of the measured values of SE380-1 and SE380-2.

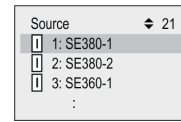

Relay R_IN_1 is controlled by the **average** of the measured values of SE380-1, SE380-2 and SE360-1.

Important: If there are more than one devices (sources) assigned to a relay (difference or average) then those devices should be programmed to measure the same parameter (DIST, LEV, ...) in the same unit (m, ft, inch, ...) Otherwise an error message (Program) will appear. See 5.7, 5.8 and 6

5.1.4. Entering Parameter Values

Parameters are signed and have values. Use the and buttons to move the cursor through the digits.

To change the values under the cursor, use the and buttons.

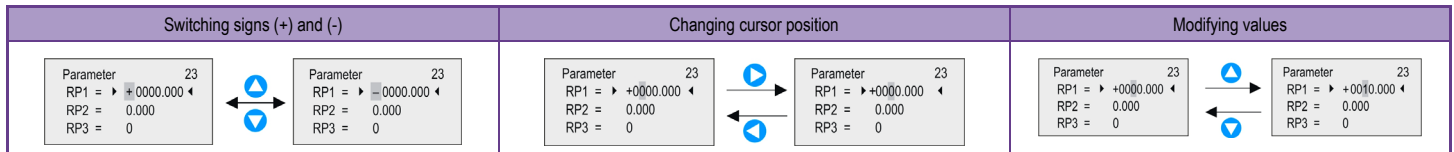

can be used to quit without saving.

To save the parameters, press after RP3.

5.1.5. Editing Strings (e.g. Short TAG)

The scrolling order of characters is as follows:

ABCDEFGHIJKLMNOPQRSTUVWXYZ [\] ^ _ ! " # \$ % & ' () * + , - . / 0123456789 : ; < = > ? @

The character at the cursor is INVERTED:



5.2. COMMISSIONING A MultiCONT NETWORK

To commission the network, follow the steps below:

- **Setting up transmitters.**

Transmitters must be given a unique „Short address.“ If there are multiple transmitters in the network, addresses must not be zero.

- **Adding devices to the device list.**

See chapter 5.2.3.

- **Configuring transmitter status.**

When devices (transmitters) are added to device list, they are activated as soon as they are detected. The MultiCONT polling them continuously, which stops when the device is deactivated (see chapter 5.2.3).

- **Detecting Universal Interface Modules:**

The detected modules (relays, current outputs) become inactive, meaning that MultiCONT does not control them.

- **Relay configuration.**

Relays have to be assigned to one or more transmitters (sources), the operating mode (function) must be specified, switching points must be configured (parameters RP1...RP3), and it must be activated. See chapter 5.7.

- **Current output configuration.**

It is similar to configuring relays. See chapter 5.8.

5.2.1. Preparation of the Transmitters and the Universal Interface Modules.

5.2.1.1 Preparation of the Transmitters

During this procedure, programming of the **current outputs** and “**Short address**” (see Manual of the transmitters) of the transmitters should be checked in laboratory circumstances. The highest loop current of the base model of the **MultiCONT** is 60 mA, and 22 mA of the Ex certified version. If the loop current exceeds the specified values, the voltage at the terminals of the transmitters will drop below the minimum required for the devices to operate reliably. They may work, but HART signals will be distorted to the extent that communication will either be faulty or cease entirely. In networks with only one transmitter, the unit’s short address can be set to 0, then its output will operate in the 4...20 mA range. If there are multiple transmitters in the loop, short addresses must be set between 1 and 15, and the output current of the transmitters will be automatically limited to 4mA. The fixed output current parameter can override this value (see transmitter manual). Loop current must not exceed the specified limit. Devices may not have the same “**Short address**” or “**Long address**” to prevent errors.

Modification of the “**Short address**” can be performed with Eview2 configuration software, or with the MultiCONT. In this case transmitters should be connected and detected one by another and set the appropriate “**Short address**”. The “**Long address**” of the device is given by the manufacturer, which cannot be modified by the user.

Data for NIVELCO made devices				
DEVICE TYPE	„SHORT ADDRESS” PARAMETER	CONSTANT CURRENT PARAMETER	DEVICE TYPE ID	DEFAULT „SHORT TAG”
EchoTREK 4-wire	P19	P08	1	XXXXXX here xxxxxx is the order or type code of the transmitter e.g.: STA380
EchoTREK 2-wire			3, 4	
EasyTREK			2	
NIVOCAP			5	
NIVOTRACK			6	
NIVOPRESS	P13		21	DB500
UNICONT			22, 23	PDF400
THERMOCONT			20	TB500

5.2.1.2 Preparing the Universal Interface Modules

The MultiCONT can be expanded by a maximum of 32 universal interface modules. They can be differentiated from each other using their “Short Addresses.” Two or more modules with the same address must not be in one system. Configuration is possible using the row of DIP switches that can be found on the top of the modules (0...31).

5.2.2. Wiring

Wiring has to be done according to the previous instructions (See chapters 2.: Technical Data and 4.1: Cable Terminal Arrangements)

5.2.3. Commissioning the MultiCONT

No HART device

Switching on initiates a 40-second test process, during which the unit tests the integrity of the memory, where settings are stored (See 5.9 The Boot Process). If the test is successful, the following message appears on the screen, which means the device table still empty.

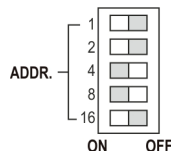

Example for setting the address:
4+8=12, this is the “Short Address” of the module

To **choose a Language** (English, German, French, Hungarian), go to **Main menu / MultiCONT config / Language** using the \uparrow and \downarrow buttons and confirm it by pressing the \rightarrow button.

The device will switch to the selected language immediately.

Select **Main menu / MultiCONT config / DEV detect**, to detect devices in the loop.

It is crucial not to confuse the **Short address** with the **List-tag** of the units. For the HART-capable devices to be discoverable and identifiable, it is necessary to assign a unique **Short address** to each of them, ranging from 1 to 15 when they are programmed. The MultiCONT registers devices based on their **List-tags**, ranging from 1, ... 8, 9, A, B, ... F.

The next step is to configure the general settings of the system (display, backlight, etc.) in **Main menu / MultiCONT config**. See chapter 5.4.

Relays (see chapter 5.7) and current outputs (see chapter 5.8) must be programmed according to the requirements of the application.

Settings can be protected by setting up a password in **Main menu / MultiCONT config / Password** and by using the K1 switch (hardware protection) on the flip side of the front panel (see chapter 7).

5.3. MAIN MENU

The **Main Menu** can always be accessed in measurement mode by pressing **OK**.

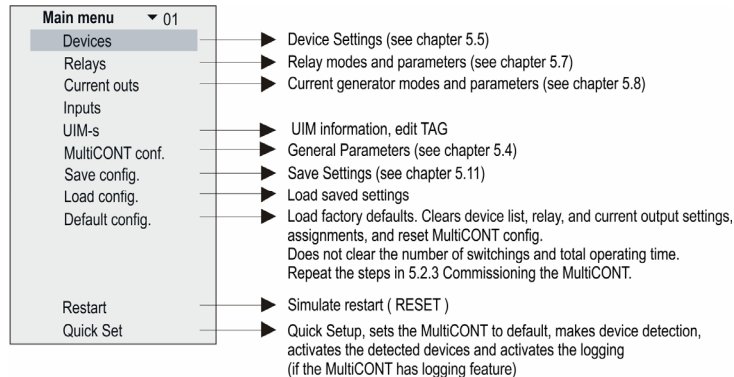

5.4 MULTICONT CONFIGURATION

The current menu item is in a gray rectangle (cursor).

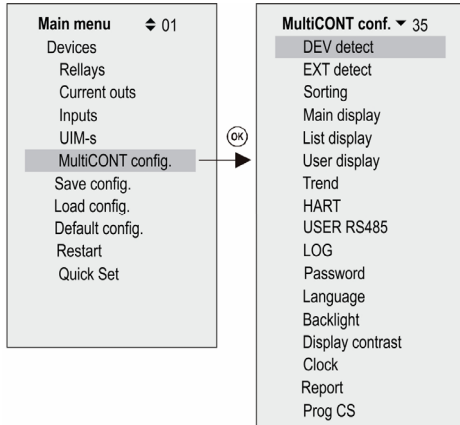

Navigate in the menu by using the and buttons, select items with the button.

5.4.1. DEV detect:

Queries the transmitters via HART line from 0 to 15, and lists them with 1...9, A, B, C, D, E, F tag.
(see 5.2.3. Putting the MultiCONT into operation)

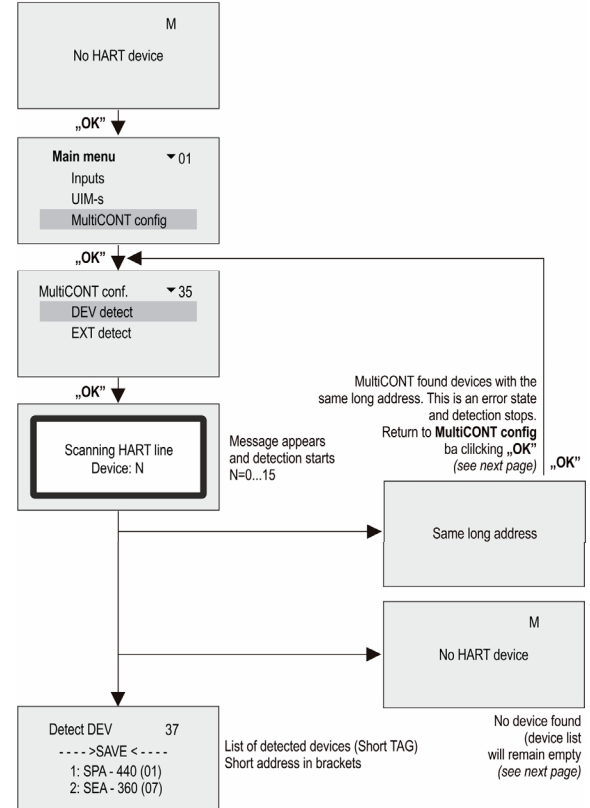

The **MultiCONT** detects devices by their Short address (that is why all short addresses must be unique within the system). However, it queries the devices by their Long address, which consists of the followings:

- **Manufacturer's ID:** (See APPENDIX 1. At the end of the Manual (for NIVELCO products it is:151
- **Device type ID:** device type identification number (see chapter 5.2.1.1)
- **Device ID:** generated when the device is manufactured (0...16777215)

If detection stops with the **“Same Long Address”** error message, there are two ways to identify the devices that have the same long address

- Devices must be removed one by one until DEV detect program completes successfully. One of the devices remaining in the loop has the same address as the removed unit. Reconnect the devices one by one, and after detection completes, the Factory ID, Device Type ID, and Device ID can be read in Main Menu / Devices (see chapter 5.5 Device Programming).
- The Long Address of HART capable devices can be read using Eview2 (by setting it to work with Short Addresses).

Users cannot modify **Long Addresses**; therefore, units with Long Address related problems should be sent back to the manufacturer. Call our Sales Department for help.

If the MultiCONT does not find all the devices, the following scenarios may come into play

1. One of the transmitters is not HART compatible. Check the label of the transmitters.
2. Faulty device. Dismount the unit and have it repaired or replaced.
3. Faulty wiring.
4. The terminal voltage of the unit is too low, check the current output configuration of the transmitters (See chapter 5.2.1.1 *Preparing the Transmitters*)

5. If none of the devices respond:

- If there is no voltage between the L+ and SH terminals, then the output is faulty, or there is a short-circuit.
- If voltage is present between L+ and SH, check for a short-circuit between L+ and L- terminals, or a break in the circuit.

Next is adding devices to the list and setting up the devices.

Search results may be the following:

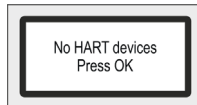

No HART device was found in the loop

Device is found in the loop:

The devices above ---→SAVE←--- are already on the list.

This list is empty if the unit is either newly manufactured or if reset (Main menu / Default). Units under ----→SAVE←--- are not on the list but have responded to the query. “Short Address” (Polling Address) appears in brackets. If a unit on the list responds, its “Short Address” will appear in brackets.

Otherwise, it is (--).

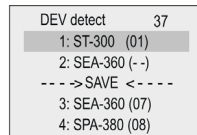

The Short TAG of responding units (either above or below →SAVE←) can be changed by selecting the device with “OK.”

MultiCONT only handles units that are above →SAVE←.

Note:

If the number of devices in the loop is known and the MultiCONT detected them already, the detection process can be interrupted by pressing the ← button (the ← button should be held until **“DEV detection end”** message appears).

Follow the steps below to reorganize the list:

- Select the unit using the and buttons.
- Press the button to move the unit to the end of the list at the other side of the line.
- Selecting the SAVE line saves the list above the SAVE line.

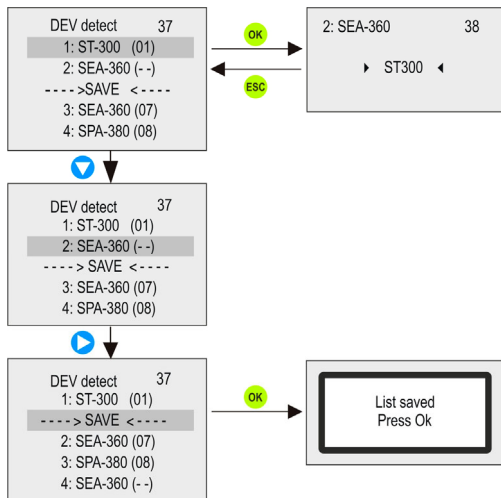

“Short TAG” can be modified

Note:

When pressing the \rightarrow button does not move the selected device above the --- SAVE --- line it means that the list above the --- SAVE --- line is full and you cannot add more devices. The length of the list depends on the type of the MultiCONT (1, 2, 4, 8, 15, see order code).

Saving the list above the ----> SAVE <---- line

The units in the saved list automatically become active!

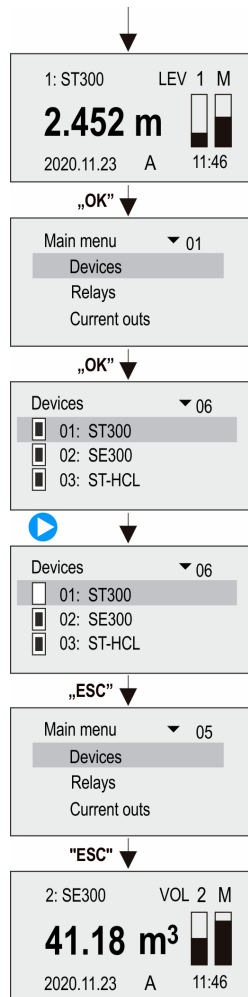

Once back in measurement mode the measured values of the devices found during detection are displayed one after another on the display. For the meanings of the captions on the display see 5.10 (Measurement mode). If the measured data of a given device are not needed temporarily, no needed to delete it from the list, it is enough to inactivate it in the following manner.

Devices is active
Select the device with and and deactivate it by pressing

Inactive devices
 Active devices

Upon re-entering measuring mode the measured values of the inactive device are not shown on the display and states of assigned relays and current outputs do not change.

5.4.2. EXT detect:

To detect external expansion modules (relays, current loop outputs, or combined) if available.

The query process is similar to that of the DEV detect mode, the only difference being that the modules that are on the list remain inactive.

(See 5.2.3 Commissioning the MultiCONT)

The detected relays or current loop outputs (4...20 mA) will be placed at end of the Detected EXT list.

5.4.3. Main Display:

The main screen consists of the "Primary Value," the "Value List" and the "Status Field" See 5.10.

The "Primary Value" and the "Value List" are freely selectable for each device.

The quantity to be displayed and the rounding of the decimal part can be set in the „Main display“.

This is where to configure the stepping of the results of the transmitters on the display.

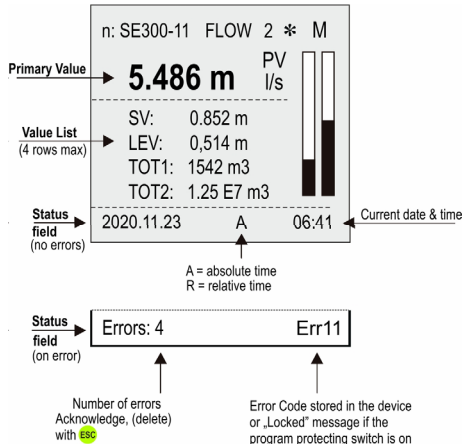

5.4.3.1 Source

The quantity to be displayed as the Primary Value can be selected independently for each transmitter.

Check your selection in Main menu / MultiCONT config / HART / CommandSet, to select the command for the appropriate value.

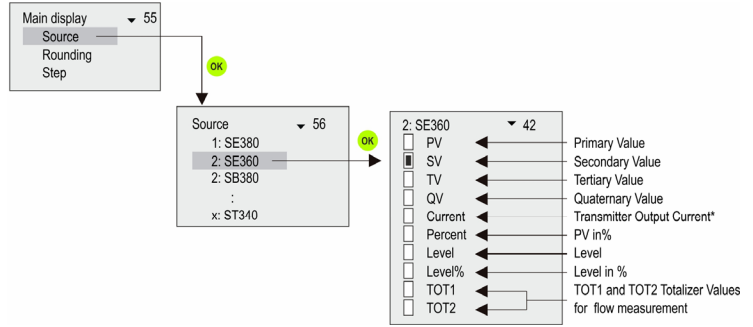

* Output current changes only if there is just one device in the system, and its "Short Address" must be zero; otherwise, the current output is constant.

5.4.3.2 Rounding

The MultiCONT rounds values to 4 decimals by default; rounding is for the primary value only

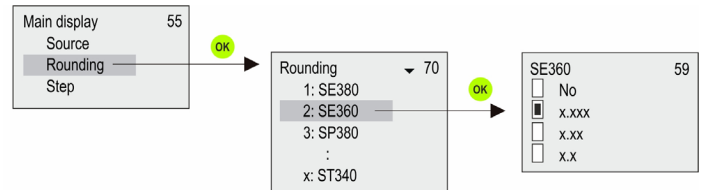

5.4.3.3 Stepping

Stepping is display-related only. Transmitter polling, relay and current output control operate continuously depending on the cycle time, set in Main menu / MultiCONT config / HART / Cycle time.

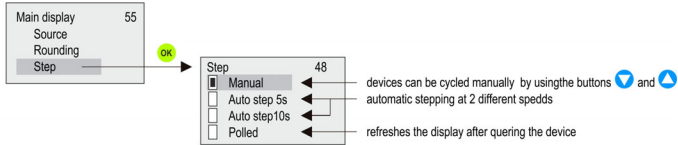

5.4.4. Value list

Four values can be selected altogether.

* Output current changes only if there is just one device in the system, and its "Short Address" must be zero; otherwise, the current output is constant.

** The MultiCONT calculates the PV's rate of change every 5 seconds. If there are more transmitters in the loop and cycle time is longer than 5 seconds, the calculation of PV_Rate (t1-t2 ≥ 5 sec) is performed every cycle. Change speed rate of PV [PV/min]=(PV_{t1}-PV_{t2})×60/(t1-t2)

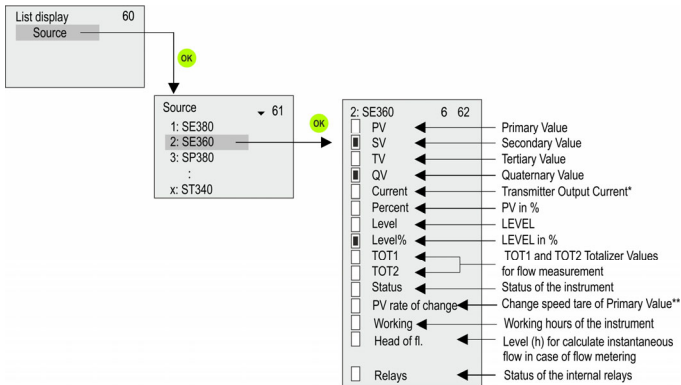

5.4.5. User Display:

Users can choose the display format for the User Display in measuring mode (see chapter 5.10). User display will show an error message only if:

- Only one device is selected to display multiple, difference, or average.
- The corresponding units or dimensions of the devices are different while measuring difference or average.

5.4.5.1 Editing the user display

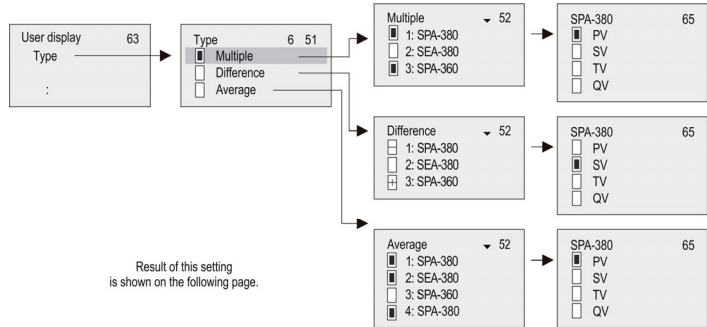

5.4.5.2 User Displays

Multiple	Difference
<div style="border: 1px solid black; padding: 5px;"> 1: SPA-380 LEV <input type="checkbox"/> U SV=12.45 m 3: SPA-360 VOL <input type="checkbox"/> U SV=125.3 m3 </div> <p style="text-align: right;">Bargraph / Output range</p>	<div style="border: 1px solid black; padding: 5px;"> 1: SPA-360 LEV <input type="checkbox"/> U +PV=12.45 m 3: SPA-380 LEV <input type="checkbox"/> U -PV=15.32 m </div> <p style="text-align: right;">difference of SPA-360 and SPA-380</p>
Average	
<p>List ID of the devices whose average value is calculated by the MultiCONT</p> <div style="border: 1px solid black; padding: 5px; margin: 10px 0;"> A:134 <input type="checkbox"/> U 3: SPA-380 LEV <input type="checkbox"/> U PV=15.32 m 3.19 m </div> <p style="text-align: right;">The average value calculated from the measurement result of the selected devices can be cycled using and the calculated average</p>	

5.4.6. HART

This menu is for configuring the properties of the MultiCONT, the transmitter query settings, and selecting the particular HART commands, which the MultiCONT uses to communicate with the devices

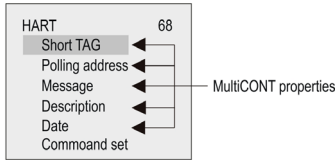

5.4.6.1 MultiCONT Short TAG

Arbitrary 8-character identifier.



5.4.6.2 Polling Address

If multiple MultiCONTs are connected to a single system via RS485, they are distinguished by this address.



5.4.6.3 Message

An arbitrary, operation-related message, 32 characters long. To change rows, use „OK” and „ESC”.

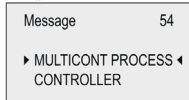

5.4.6.4 Description

An arbitrary 16 characters long text that describes the device).

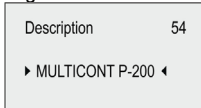

5.4.6.5 Date

The date set in the MultiCONT

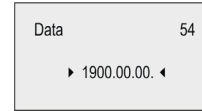

5.4.6.6 Command Set

The MultiCONT and the devices communicate using different commands. The MultiCONT sends a command containing the address of the device, which sends a standard response. Some of the commands are universal, while others are device-specific. The appropriate commands are selected automatically based on the data required to control the display, relays, and current outputs.

If a command, which is crucial for proper operation, is deactivated, a "Program failure" message is generated on the relays and current outputs. The display flashes, says that results are not refreshed because a HART command necessary for this operation is deactivated. **Therefore, modifying the commands is not recommended!** If multiple commands are selected, refresh time increases (display, relay, and output current modification).

The MultiCONT uses the following commands to communicate with the devices:

- COM1: query for primary value
- COM2: output current in mA and % (output range)
- COM3: primary, secondary, tertiary, and quaternary values

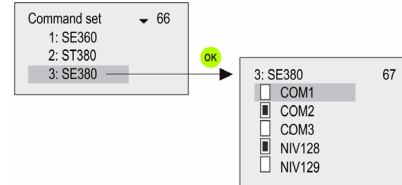

These commands can be interpreted by any device belonging to any manufacturer.

The commands below can only be interpreted by NIVELCO products:

- NIV128: device specific command optimized for DIST, LEV, VOL measurements
- NIV129: device specific command optimized for DIST, LEV, FLOW, TOT1, TOT2 measurements.

The table below shows the contents of the responses of NIVELCO devices to the commands as indicated.

COM3: 03 Universal HART command

P01	EchoTREK 4-wire EasyTREK				EchoTREK 2-wire EasyTREK				NIVOTRACK				NIVOCAP									
	PV	SV	TV	QV	PV	SV	TV	QV	PV	SV	TV	QV	PV	SV	TV	QV						
0	DIST	LEV	DIST	Temp	DIST	Temp	-	-	DIST	Temp	-	-	%	-	-							
1	LEV				LEV	DIST	Temp		LEV	DIST	Temp		LEV	DIST			Temp	LEV	%			
2	LE%				LE%	LEV	DIST	Temp	LEV	DIST	Temp	LE%	LEV	DIST			Temp	LE%	LEV	%		
3	VOL				VOL							VOL						VO%			VOL	VO%
4	VO%				VO%							VO%						VO%			VO%	VO%
5	FLO				FLO							FLO						FLO			FLO	FLO

P10	NIVOPRESS				UNICONT				THERMOCONT			
	PV	SV	TV	QV	PV	SV	TV	QV	PV	SV	TV	QV
0	P*	-	-	-	Prog**	I _{in}	-	-	Temp	-	-	-
1	P*								P*			
2	LEV	LEV	LEV	LEV								
3	LEV	LEV	LEV	LEV								

* P: pressure

** Prog: the value calculated by the device from the input current (I_{in}).

During configuration, it is necessary to set the value (e.g. 4 mA = 0 m³, 20mA = 125 m³) corresponding to the incoming 4...20mA (I_{in})

See the relevant data in the User's & Programming manual of the transmitter.

NIV128: NIVELCO device specific commands optimized for VOL measurement

P01	EchoTREK 4-wire, EasyTREK				EchoTREK 2-wire, EasyTREK				NIVOTRACK				NIVOCAP			
	PV	Base	3. Pos.	4. Pos.	PV	Base	3. Pos.	4. Pos.	PV	Base	3. Pos.	4. Pos.	PV	Base	3. Pos.	4. Pos.
0	DIST	LEV	SR*	Curr.	DIST	LEV	SR	Curr.	DIST	LEV	SR	Curr.	%	LEV	0	Curr.
1	LEV		LEV													
2	LE%		LE%													
3	VOL		VOL													
4	VO%		VO%													
5	FLO		FLO													

* SR (sensor range): Value of level difference between the "Maximum range" (H=P04) and the "Minimum range" (near dead zone blocking) in % (empty tank: DIST=H ⇒ 0%, full tank: DIST= "Minimum range" ⇒ 100%). Necessary for displaying bar graph.

NIV129: NIVELCO device specific commands optimized for FLOW measurement
(TOT1 and TOT2 in float format)

P01	EchoTREK 4- wire, EasyTREK				EchoTREK 2- wire, EasyTREK				NIVOTRACK				NIVOCAP			
	PV	Base	3. Pos.	4. Pos.	PV	Base	3. Pos.	4. Pos.	PV	Base	3. Pos.	4. Pos.	PV	Base	3. Pos.	4. Pos.
0	DIST	LEV	TOT1	TOT2	DIST	LEV	TOT1	TOT2	DIST	LEV	0	0	%	LEV	0	0
1	LEV				LEV											
2	LE%				LE%											
3	VOL				VOL											
4	VO%				VO%											
5	FLO				FLO											

5.4.7. USER RS485

The **MultiCONT User RS485 interface** provides serial data transfer to the central process controller computer or a PLC. The following can be queried from MultiCONT through the communication line:

- system properties (MultiCONT configuration, relays, current outputs, transmitters, errors, number of Universal Interface Modules, etc.)
- error list
- relays and current outputs assigned to devices
- relays and current output configuration
- device output values

The MultiCONT units have separate addresses (default 1) so they can be connected to a single system. (up to 30 MultiCONT).

There are two communication protocols:

- HART 5
- MODBUS RTU (default)

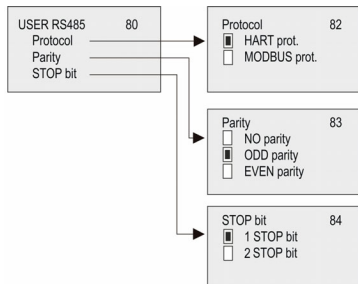

5.4.8. Data Logger

The MultiCONT logger has two main parts with the following functions:

- **Trend logger:** on a separate board, in PED-, PRD-, PEN- and PRN- types. The accumulated data is stored on a FLASH card or an SD card. The unit logs the ID of the transmitters, the primary value, and three additionally selectable values.
- Time-controlled logging, whereby entries are stored after a specified amount of time has passed.
- Event-controlled logging, whereby entries are stored when a predetermined condition is fulfilled.

There are two types of time-window logging for flow-metering. The accumulated data is stored on a FLASH memory card.

- Time-window TOT: TOT is calculated for a selected time interval, monitoring the average, minimum, and maximum values of the flow.
- Time-window FM: the eight highest flow values during a pre-set period are stored with their timestamp.

The time-windows are independent from the trend logger and all four saving modes can operate at the same time (time/event-controlled, time-windows).

The time-window logger function can be used only for NIVELCO manufactured transmitters in flow-metering mode.

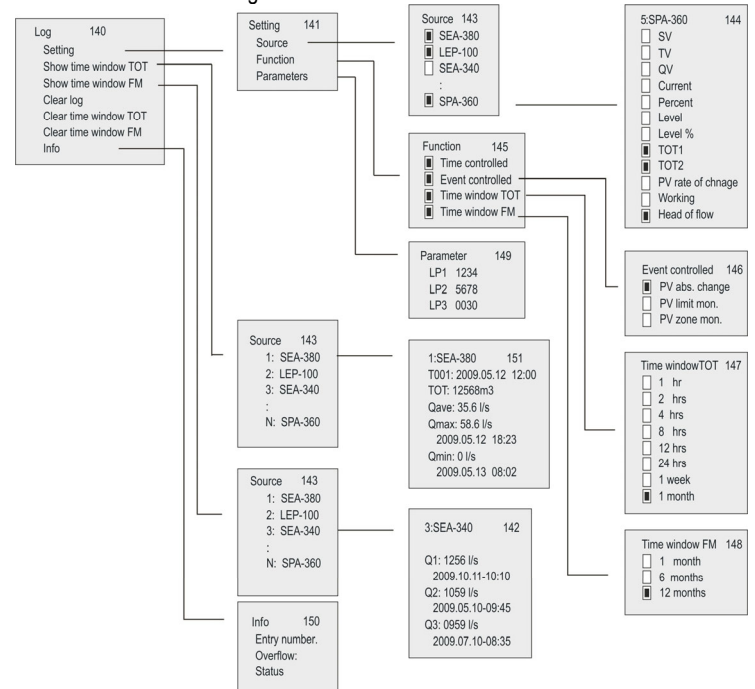

5.4.8.1 Trend logger

Trend logger function is only available on PRD- and PED- instruments. Trend logging can be time-controlled (store an entry after a programmed time elapse) or event-controlled (logging upon measurement changes). These two modes can be working simultaneously and conditions of the logging can be set from the menu (programmed trend logging). Logged entry contains the necessary data to identify a transmitter, the time of the entry, the primary value of the transmitter, and three additional menu selectable values.

If there is one or more THERMOPOINT temperature transmitter in the system, in addition to the PV and 3 freely-chosen values, it is also possible to log all the measured temperature points by selecting the **Main menu -> MultiCONT conf. -> LOG -> Settings -> Source -> All values** menu.

The result of the logged data is displayed as shown in the LOG data file (LT record).

NIVELCO DataLogger Ver.:1.0.3.5 Multicont Ver.:01.02.26																										
Date:2015.06.29 13:14																										
Hea	Date	Time	Type	Dev	Addr	Tag	Err.	Status	Curr0	Value0	Unit0	Curr1	Value1	Unit1	Curr2	Value2	Unit2	Curr3	Value3	Unit3						
LT	2015.06.29	13:11:00		2	1 151.18.15978248	TMH-500	0	320	15	degC	26.4	26.2	25.8	26.2	26.1	26	25.7	26.1	26.1	25.9	25.7	25.6	25.7	25.6	25.7	25.6
LG	2015.06.29	13:11:02		2	1 151.18.15978248	TMH-500	0	320	TEMP	26.399999	degC	?	NaN	(null)	?	NaN	(null)	?	NaN	(null)						
LT	2015.06.29	13:11:02		2	1 151.18.15978248	TMH-500	0	320	15	degC	26.4	26.2	25.8	26.2	26.1	26	25.7	26.1	26.1	25.9	25.7	25.6	25.7	25.6	25.7	25.6
LG	2015.06.29	13:11:04		2	1 151.18.15978248	TMH-500	0	320	TEMP	26.399999	degC	?	NaN	(null)	?	NaN	(null)	?	NaN	(null)						

Data are stored into the FLASH memory in the first step. Capacity of the FLASH memory is 65000 entries. Then if data are stored into an SD (Secure Digital) card, the capacity is depended on the SD card. The readout of the on-board memory can be performed via the USB port with an ordinary commercial USB cable (USB A-B cable). Usage of the SD card is detailed in the chapter 5.4.8.4.

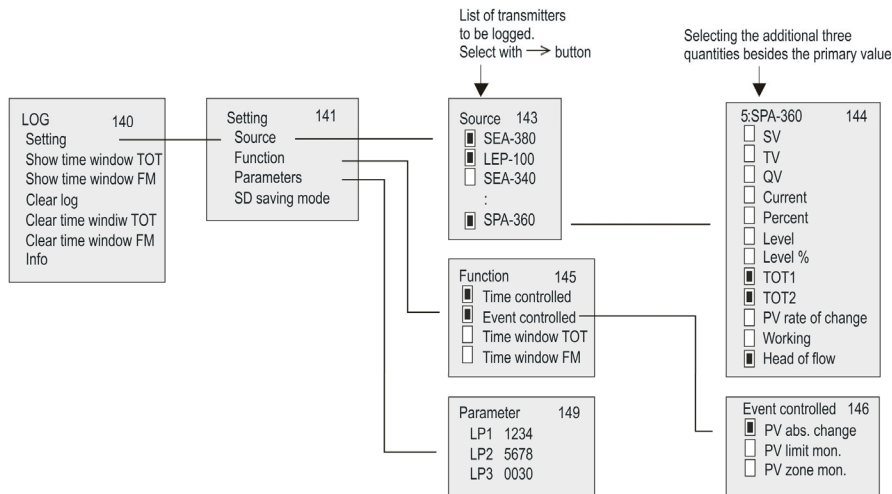

For using the trend logging function, the following data should be set:

- In the "Source" menu point the transmitter can be selected which measured value will be logged and the additional three values can be selected to be logged besides the primary value
- In the "Mode" menu point the logging mode (time-controlled, event-controlled or both) can be selected.
- In case of time-controlled logging mode in the "Parameters" menu point the logging interval should be entered into LP3 in minutes.
- In case of event-controlled logging mode in the "Parameters" menu point LP1 and LP2 parameters should be set, according to the table below:

Event-controlled trend logging

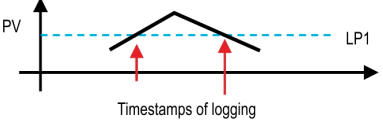
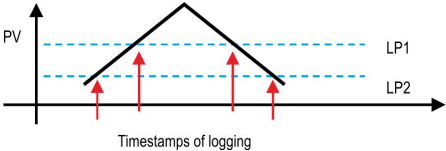
Mode	Operation	Parameters
PV absolute change.	Logging when (absolute) change of Primary value (PV) reaches the value in LP1	LP1
PV limit value monitoring	<p>The logging monitors and stores the timestamps when Primary value (PV) exceeds or falls under the value in LP1.</p> 	LP1
PV zone monitoring	<p>The logging monitors and stores the timestamps when Primary value (PV) quits from the zone defined by LP1-LP2, or when it returns into the zone.</p> 	LP1 LP2

In case of time-controlled trend logging the average of the selected values will be stored within the time interval which is set in LP3 parameter.

Mode and parameters of the logging are the same for all transmitters. Logging function commences when exiting the "LOG" / "Settings" menu point.

Besides the measurement values of the transmitters there are many events (which affect the operation of the whole system) stored in the trend logger regardless the programming (see chapter 5.4.8.5).

5.4.8.2 Time-window TOT (Total flow logging)

This function is only available for NIVELCO manufactured transmitters operating in flow measurement mode (for this option NIV129 should be selected in "Main menu"/"MultiCONT conf."/"HART"/"Command set"). Within the selected time interval MultiCONT counts the total flow (TOT), the average flow (Qave) and monitors the maximal and the minimal flow. The length of this time interval can be selected from the menu. Up to 256 time-windows can be stored.

Time window TOT 147

1 hr

2 hrs

4 hrs

8 hrs

12 hrs

24 hrs

1 week

1 month

Read logging data:

"Main menu"/"MultiCONT conf."/"LOG"/"Show time window TOT" ↑, ↓, OK and → buttons are used for stepping in the list (OK moves down 10 lines, → moves up 10 lines in the list) T000 is the unfinished "Time-window 1". T001 is the last finished time window. Increasing nnn, the time can be incremented. nnn=0...255

2: SE300	151	— Identifier of the transmitter
Tnnn: 2010.01.12-09:13		— Number of „Time-window TOT“ and time of start
TOT: 15689 l		— Total flow
Quave: 12.56 l/s		— Average flow
Qmax: 54.23 l/s		— Maximum flow with time
	2010.01.12-11:23	
Qmin: 4.53 l/s		— Minimum flow with time
	2010.01.12-13:56	

5.4.8.3 Time-window FM (Flow Maximum logging)

This function is only available for NIVELCO manufactured transmitters operating in flow measurement mode (for this option NIV129 should be selected in "Main menu"/"MultiCONT conf.:"/"HART"/"Command set").

The 8 highest flow values are stored with time within the time interval selected in the menu.

Read logging data:

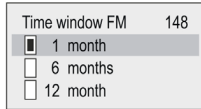

2: SE300	142
Q1:	458.56 l/s 2010.01.13-15:25
Q2:	418.13 l/s 2010.01.14-07:47
Q3:	356.98 l/s 2010.01.22-23:01

Identifier of the transmitter
Highest flow with time
2nd highest flow with time
3rd highest flow with time

"Main menu"/"MultiCONT conf.:"/"LOG"/"Show time window FM" ↑ and ↓ buttons are used for stepping in the list.

5.4.8.4 Using a memory card for logging

Trend logging function is facilitated by a LOGGER unit connected to the front panel. It contains a FLASH memory chip and an SD (Secure Digital) card slot. Communication between the central unit of the MultiCONT and the LOGGER unit is indicated by two LED-s on the front panel. The green LED (read) flashes when a new logging entry is created, the red LED (wire) indicates when data are stored to the SD card. For storing data an SD (Secure Digital) memory card with maximum 32 GB capacity is recommended. In case of PED-, PRD-, PEN- and PRN- models (which are able to trend logging) checking of the LOGGER unit is done when turning it on. Then the following box messages will be shown on the display in accordance to the result of the logging procedure:

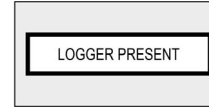
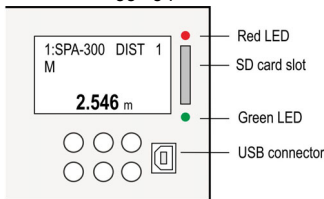

Everything is OK
Red and green LED-s are flashing
until this caption appears

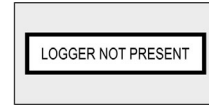

LOGGER card is not working properly
In this case P-200 :
LOG IP entry will be created in
the error-list

This procedure is repeated in every turning ON/OFF and restart.

Then the measurement data are sent continuously to the LOGGER unit (flashing green LED indicates) and in case of fulfilment of the selected conditions (see chapter 5.4.8.1) they are logged, which is indicated by the flashing red LED.

Capacity of the on-board FLASH memory is 65000 entries. When this memory is becoming full and there is no SD card in the card-reader, the old entries will be overwritten so the logging will be performed by a "rotation". Number of overflows can be read out in the "LOG"/"Info" menu point. When there is an SD card in the slot the read and write process is done with the frequency selected in "LOG"/"Settings"/SD saving mode" menu point.

The LOGGER unit of the MultiCONT senses automatically the inserted SD card. Then saving the FLASH memory into the memory card commences automatically. State of this process can be followed in the trend bar graph. Before remove the memory card, the end of the write process (when the red LED does not flash) has to be waited. In order to avoid removing the card during the write process, push the ESC and the ↑ buttons at the same time. Then the following box message will be shown on the display:

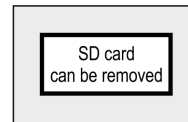

From this moment the MultiCONT does not send any data for 10 seconds to the LOGGER unit (write is unavailable) and the SD card can be safely removed.

5.4.8.5 File system of the SD card and file content of a logging entry

When inserting an SD card into the MultiCONT, content of the on-board FLASH memory is loaded automatically into the memory card (this is indicated by continuous flashing of the red LED during write process). The LOGGER unit finds the last dated directory and examines if the files are more than 200 in this subdirectory. If not, MultiCONT continues the write process. If there are more than 200 files, a new directory is created. One logging file can contain max. 1000 entries, but new logging files are created when turning ON/OFF, restart of the MultiCONT and exiting from the LOG menu.

After finishing the saving process to the SD card, data are able to open in any PC with appropriate SD card-reader. The logging file is a special TAB articulated text file, which can be read with any spreadsheet application if necessary.

Name of the sub-directories on the card:

PRddd where ddd=001...999

Name of files in the sub-directories:

R f f f f f f . T X T where fffff=000001...999999

The created file-system looks like in the following:

PR001	1 st directory
PR000001.TXT	
PR000002.TXT	
PR000003.TXT	
PR000200.TXT	
PR002	2 nd directory
PR000201.TXT	
PR000202.TXT	
PR000252.TXT	
PR003	3 rd directory
PR000253.TXT	
PR000254.TXT	

The PRfffff.TXT named logging files in the directories consist of two main parts: header and data field. The header contains the following information:

NIVELCO DataLogger Ver.:1.08 MultiCONT Ver.:01.02.02

<< DataLogger and MultiCONT version

Date:2001.01.01 01:02

<< Date of file creation

Data field contains the following data rows:

Title	Description	Example
Head	Logging entry code	(LG = logger, ST = status, SD = mem. card operation, ER = error message, VO = time of switching OFF)
Date	Logging entry date	2010.05.07
Time	Logging entry time	13:01:40
Type	Logging entry type (see Type codes)	2
Dev	List-tag of the source device	3
Addr	HART Long address of the transmitter	151.30.2555904
Tag	Short tag	SAP-300
Err.	Error	0
Status	Status	0
Curr1		FLOW
Value1	Primary Value	125.67
Unit1		m3/h
Curr2		LEV
Value2	Selected additional 2 nd quantity	0.567
Unit2		m
Curr3		TOT2
Value3	Selected additional 3 rd quantity	12345678
Unit3		m3
Curr4		Work
Value4	Selected additional 4 th quantity	1548
Unit4		h

Comments:

- If logging entry type is not 2, then MultiCONT is the source (DEV=255, TAG=P-200, Error=0, Status=0), instead of the PV and the three additional selected values use NAN (no data) caption can be read.
- Insertion of SD card:
SD 2010.05.07 13:01:40 SD pushed
- Removal of SD card:
SD 2010.05.07 13:01:40 SD pulled
- In case of ST entries, the selected values in LP1, LP2 and LP3 parameters can be read out from Value1, Value2 and Value3
- In case of ST entries, the following codes are in the Type and Dev columns:

Type:

B7	B6	B5	B4	B3	B2	B1	B0
				00=absolute value change. 01=limit value monitoring 10=zone monitoring		1= event-controlled ON	1=time-controlled ON

Dev:

B7	B6	B5	B4	B3	B2	B1	B0
				SD saving mode 000= 1 row 001= 8 rows 010= 16 rows 011= 32 rows 100= 64 rows 101= 128 rows		Number of transmitters to be logged (LOG/Settings/Source)	

The following codes can be in the type code column:

Type code	Description	Comments
0	Hardware reset	Turning ON
1	Software reset	Device restart from menu
2	Entry of measured value	Programmed TREND logging entry
3	MultiCONT CRC altered	Settings of MultiCONT have changed. CRC calculated when entering Main menu differs from the CRC calculated when quitting the Main menu.
4	TOT1 clear	Clearing TOT1 from a NIVELCO instrument used for flow metering.
5	TOT2 clear	Clearing TOT2 from a NIVELCO instrument used for flow metering.
6	MultiCONT clock set	
7	Transmitter (DEVICE) default load	Loading default settings of the transmitter from menu.
8	MultiCONT default load	
9	Logger delete from menu	
10	MultiCONT error-list clear	
11	Transmitter program CRC altered	MultiCONT checks CRC when entering and quitting remote programming mode. Logging entries are created when the two CRC differs.
12	New list saved after (DEVICE) detection	
253	Instrument respond error	Transmitter does not respond to the entered commands; it will be stored also in the error-list.
254	Instrument inactive	The instrument selected for logging is in inactive state.

5.4.9. Secret code

The viewing and modification of MultiCONT settings can be protected with a secret code differing from 00000000.

If there is a password, the following symbol  appears left of the menu identifier, and flashes after being unlocked. The password remains temporarily unlocked until returning to the measuring process.

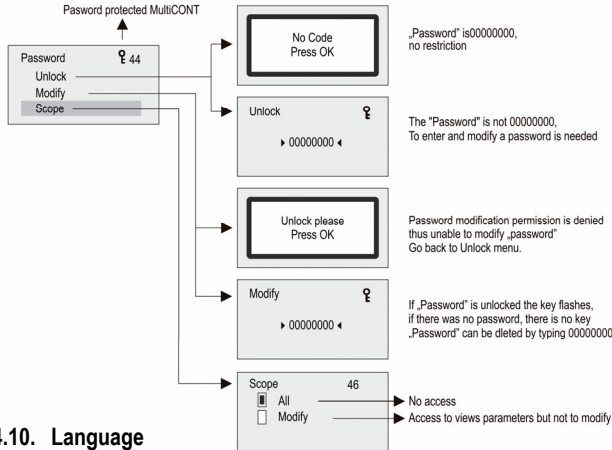

5.4.10. Language

This is where to select the language used during measurement and programming. The selected language will be switched to immediately

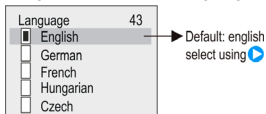

5.4.11. Background lighting

The background lighting of the display can be modified here.

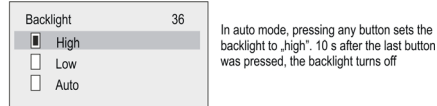

5.4.12. Report:

This provides information about the system structure. This displays the number of devices (transmitters), relays, current outputs, and modules in the system, and also the number that can be handled. Binding is when a relay or current output is assigned to a device

Report	53	
Devices:	002/015	2 devices (transmitters) in the loop, max. 15
UIM-s	000/032	No. of Universal Interface Modules (PJK-100)
Relays	004/064	No. of relays (64 = sum of maximal internal and external relays)
Current outs:	002/016	No. of current outputs
Inputs:	000/000	Other inputs
U485:	NO	RS485 user interface
M485:	YES	RS485 module interface (needed for UIM functioning)
Bindings:	005/100	No. of bindings
Type:	PEC2M9	Type of MultiCONT
SW type:	01	Software type of MultiCONT
SW version:	01.00	Software version of MultiCONT
Serial:	B9718160	Serial no. of MultiCONT processor
Date:	2005/11/15	Date of MultiCONT software update
Working:	6/18/59	MultiCONT work time (days/hrs/mins)
Power cnt:	224	No. of MultiCONT "power-on"s
Temp. min:	18°C	MultiCONT min. temperature
Temperature:	22°C	MultiCONT actual temperature
Temp max:	35°C	MultiCONT max. temperature

5.4.13. Prog CS

When exiting the menu, the device generates a Frame Check Sequence from the settings (EXCLUSIVE-OR operation of bytes)

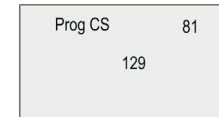

5.5. PROGRAMMING THE DEVICES

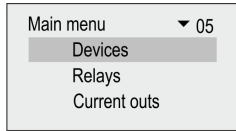

„OK“ ↓

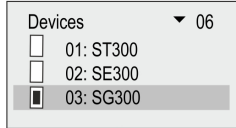

Device selection with and buttons, then press to query and modify parameters.

- Device is active
- Device is not active, but can be programmed as if it were active

„OK“ ↓

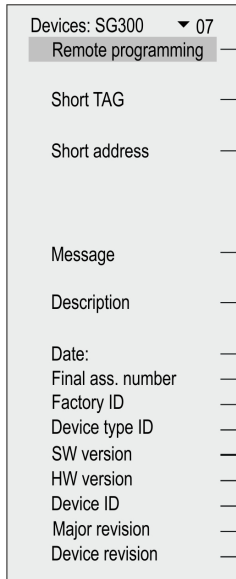

→ Programming the device and querying parameters see: chapter 5.6.*

→ To query and modify the Short TAG use , , , and after press

→ Short address** (1...15), used during detection will search for the device with this address Secret code* not needed for modification Modification should be done with care

→ Arbitrary text assigned to the device (usually related to operation, max. 32 char)

→ Arbitrary text assigned to the device (usually related to the material, max 16 char)

→ Date assigned to the device

→ Factory setting = 0

→ Factory ID, for NIVELCO devices = 151

→ Device type ID

→ Software version of the transmitter (see manual)

→ Hardware version of the transmitter (see manual)

→ Manufacturer's electronic serial number

→ HART revision

→ 0

* In case of the NIVELCO non-compatible transmitters, only the assigned **4...20 mA values and damping time** can be programmed".

** In this menu point the short address of the device will show when pressing OK button. Detected "Short address" is stored in the operative memory, turning off the device the memory content is erased. In case of this "??" will appear. It has no effect on the operation, because communication is performed via "Long address" (cannot modified) after the detection. The transmitter will have the modified address at the next detection!

5.6. REMOTE PROGRAMMING

Select the device to be programmed as described above.

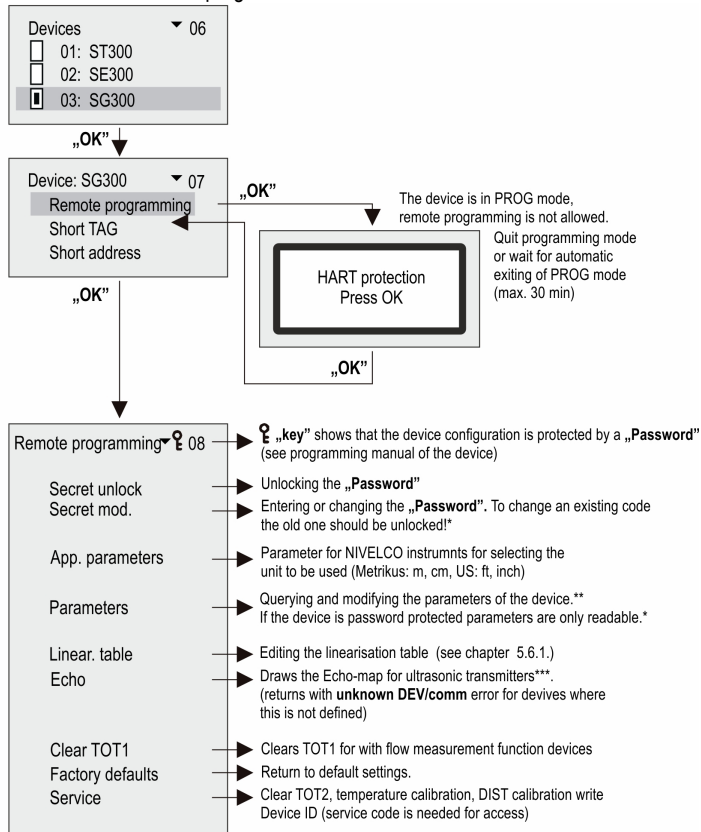

Note: Content of this menu is depended on the type of the transmitter!
For example: MicroTREK see: appendix 6. LEP-100 see: appendix 7.

* If the access is denied the following message appears.

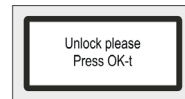

After entering a valid code press OK.

** Parameters entered during remote programming via MultiCONT will be sent without being checked to the device where the data is checked. In the event of bad parameter value, or if the given parameter is not defined in the given device, then the following message appears:

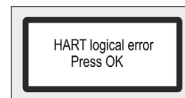

To correct the problem, see the User's Manual of the respective device (transmitter).

*** Explanation of the Echo Map of ultrasonic transmitters

On enter:

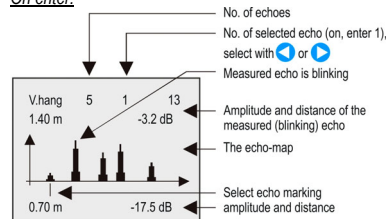

after pressing button:

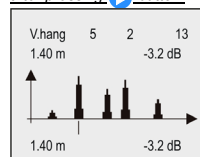

Note! The displayed data corresponds to the moment of entering into the menu. The flashing echo is the one used by the transmitter to measure distance. To refresh the display press **ESC** then **OK**

5.6.1. Editing the linearisation table

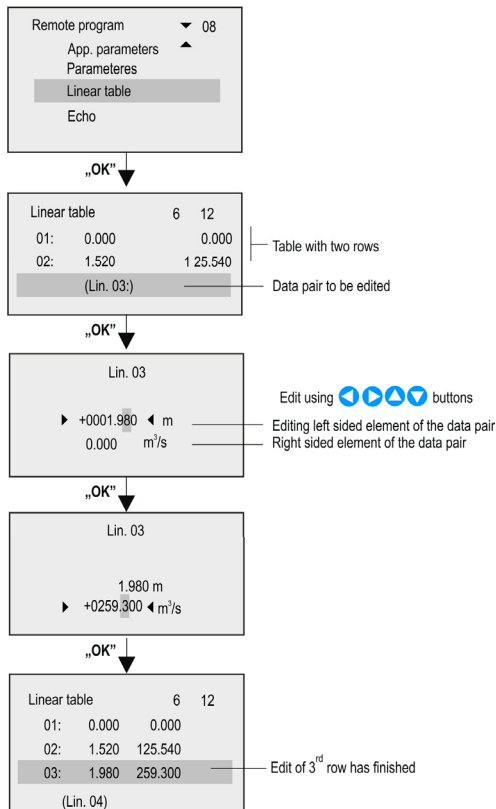

Warning! For the transmitter to compute the measurement results using the linearization table, linearization has to be enabled in parameter P47 (See the Installation and Programming Manual of the given transmitter)

5.7 RELAY CONFIGURATION

First of all it is recommended to decide which relay is to be assigned to which device(s), and to which measured value (PV=primary value, SV=secondary value, ...) in Main menu/Relays/ Program/Source.

Relays can be assigned to one or more sources (difference, average). Secondly the relay function should be selected in Main menu/Relays/ Program/Function.

Finally the parameters have to be specified in Main menu / Relays / Program / Parameter such that the dimensions of RP1 and RP2 are determined by the devices assigned to them. Thus if the chosen value is LEVEL [m] then the RPx parameters also have to be entered in LEVEL [m].

5.7.1 Selecting relays

It is impossible to enter the relay menu if the system does not contain a single relay. The number of relays in the system can be viewed under Main menu / MultiCONT config / Report. (See chapter 5.4.12.)

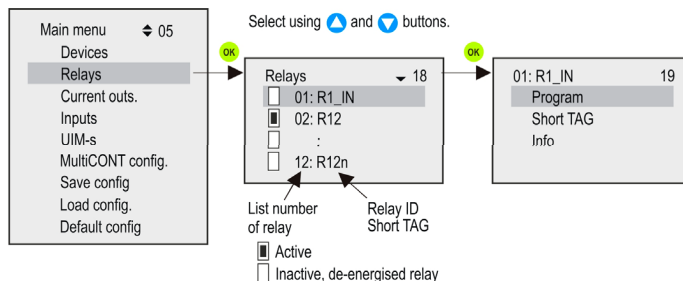

5.7.2 Relay properties

The refreshing of “Cycle”, “Working”, “Input” and “Output” takes place continuously in the case of the internal relays

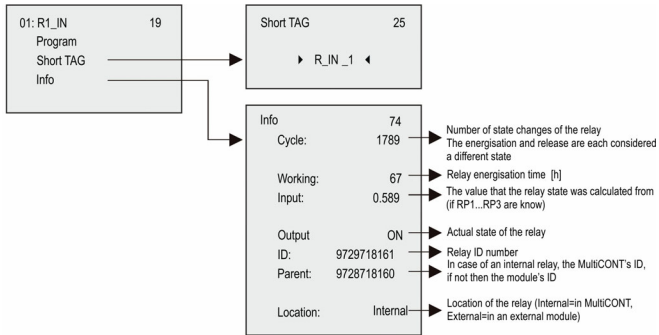

5.7.3 Relay programming

5.7.3.1 Source selection

One or more devices can be assigned to one relay.

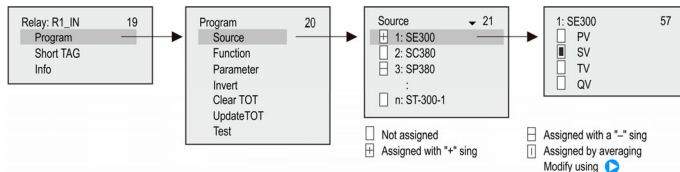

In the above example, Relay R1_IN is controlled by the difference of the secondary values of SE300 and SP380. In case of a single unit, the sign is indifferent, in fact, average might as well be selected. In case of the selection of multiple devices, control depends on the result of the mathematical sum. If in the case of selected multiple devices the dimensions of the quantities are different, the unit will display an error message. Upon selecting the quantity, confirm that the appropriate HART command has been selected for the device (See Main menu / MultiCONT config / HART / command set, see chapter 5.4.5.5).

5.7.3.2 Function

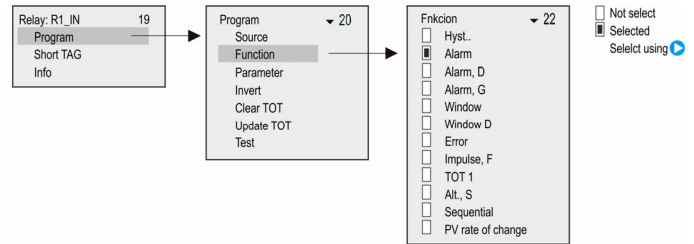

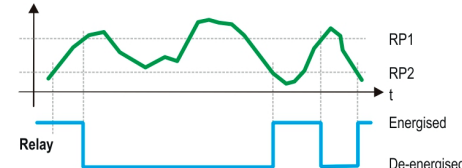
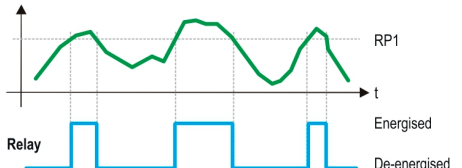
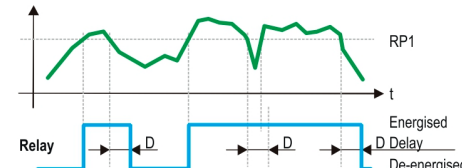
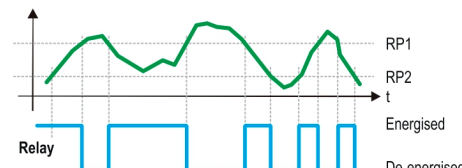
OPERATING MODE	FUNCTION	PROG. PAR
<p>Hysteresis. (2-point control)</p> <p>Default: filling with energized relay: Invert = OFF above RP1 the relay will be de-energized below RP2 it will be energized Inverted operation: by interchanging RP1 and RP2 or by selecting Invert = ON Main menu/Relays/Program/Invert If RP1 = RP2 then the upper alarm function is enabled</p>		<p>RP1, RP2</p>
<p>ALARM</p> <p>Default: Invert = OFF Below RP1 relay will be de-energized Inverted operation (relay will be energized below RP1) or by selecting Invert = ON Hysteresis = 2.5% of RP1 If RP1 = 0 the relay will be constantly energized</p>		<p>RP1</p>
<p>Alarm D (with delayed switching)</p> <p>Default: Invert = OFF below RP1 relay will be de-energized using delay in RP3 (Factory default t= 0 sec) Delay can be set under RP3 in sec</p>		<p>RP1, RP3</p>
<p>Alarm G (group ALARM)</p> <p>Default: „Invert =Off”</p>	<p>Relay get de-energized if the condition (measured value is less than RP1) is fulfilled in case of any transmitters assigned to the relay. Hysteresis: 2.5% of RP1 Operation can be inverted with Invert =On switch (Relay get de-energized if the measured value is more than RP1)</p>	<p>RP1</p>
<p>Window (window comparator)</p> <p>Default: Invert= OFF Between RP1 and RP2 relay will be energized Inverted operation (Between RP1 and RP2 relay will be deenergized) or by selecting Invert = ON</p>		<p>RP1, RP2</p>

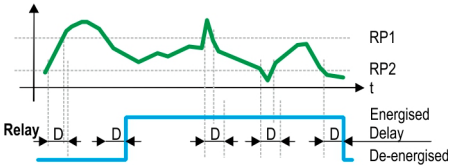
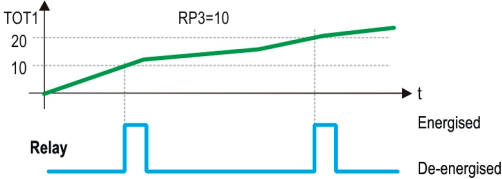
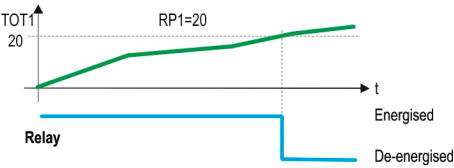
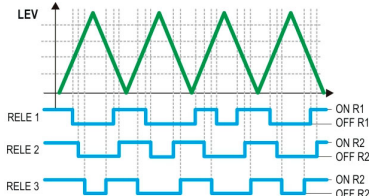
OPERATING MODE	FUNCTION	PROG. PAR
<p>Window D (comparator with switching differential) Default: Invert = OFF Between RP1 and RP2 relay will be energized using delay in RP3 (Factory default $t = 0$ sec) Inverted operation (Between RP1 and RP2 relay will be deenergized) or by selecting Invert = ON</p>		<p>RP1, RP2, RP3</p>
<p>Error Default: Invert = OFF In case of error relay will be de-energized. RP3=0 for any error; RP3=n for error of code n Inverted operation (in case of error relay will be energized) or by selecting Invert = ON</p>		<p>RP3</p>
<p>Impulse F Default: Invert = OFF relay will be energized for appr. 200ms for each unit volume set in RP3 Operation can be inverted by selecting Invert = ON Programming error will be displayed if:</p> <ul style="list-style-type: none"> • more than one device (transmitter) is marked as source • RP3=0 		<p>RP3</p>
<p>TOT1 Default: Invert = OFF relay will be de-energized when TOT1 reaches value in RP1 Operation can be inverted by selecting Invert = ON (relay will be energized)</p>		<p>RP1</p>
<p>Alt (optimized pump control) Default: Invert = OFF More relays (max 8) can be assigned to one source (transmitter) and they are controlled such that the switching number will be the same for all of them. In this case the connected relays will be energized and de-energized one after the other irrespective of which relay's conditions are fulfilled. The programmed relay operation is shown in the following diagram.</p>		<p>RP1, RP2</p>

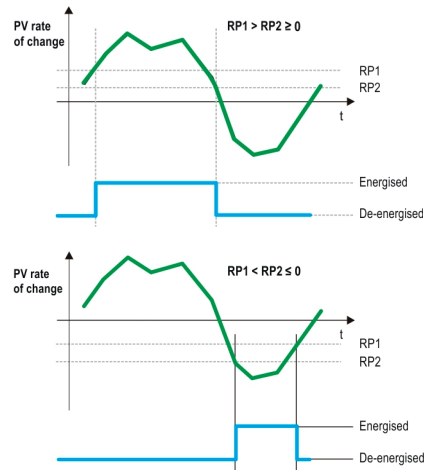
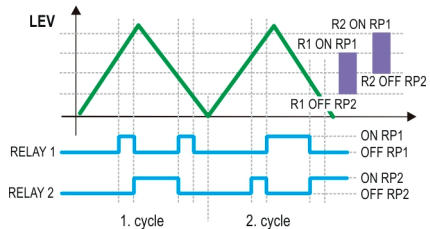
OPERATING MODE	FUNCTION	PROG. PAR
<p>PV rate of change Default: „Invert = OFF”</p> <p>The MultiCONT counts PV rate of change in every 5 seconds. When there are more transmitters in the loop and cycle time is more than 5 seconds, PV_Rate is calculated per cycles.</p> $(t1-t2 \geq 5\text{sec})$ <p>PV rate of change speed is $[PV/\text{min}] = (PV_{t1}-PV_{t2}) \cdot 60 / (t1-t2)$</p> <p>There are two operation modes, depending on the value of the parameters:</p> <ol style="list-style-type: none"> 1. $RP1 > RP2 \geq 0$ For example: Relay becomes energized when level is increasing in the tank too fast 2. $RP1 < RP2 \leq 0$ For example: Relay becomes energized when level is decreasing in the tank too fast. <p>Inversion of the operation can be performed with selecting „Invert = ON”</p>		RP1 RP2
<p>Sequential Default: „Invert = OFF”</p> <p>More operation modes are possible to use depending on the values of the parameters. There is only one relay in energized state. When all relays are in de-energized state, then new cycle is started and relays will be reversed.</p> <p>In the followings, there is an example for the operation in case of two relays (max. 8 relays can be operating in a group)</p>		
<p>Sequential</p> <ol style="list-style-type: none"> Different switching points for the relays for turning ON and OFF <p>$Rx-RP1 > Rx-RP2$</p> <p>Emptying with energized relay</p>		RP1 RP2

OPERATING MODE	FUNCTION	PROG. PAR
<p>Sequential</p> <p>2. Different switching points for turning ON and same switching points for turning OFF for the relays</p> <p>$R_x-RP1 > R_x-RP2$</p> <p>Emptying with energized relay</p>		<p>RP1 RP2</p>
<p>Sequential</p> <p>3. Same switching points for the relays for turning ON and OFF</p> <p>$R_x-RP1 > R_x-RP2$</p> <p>Emptying with energized relay In case of x (x=2..8) relays, relays are operating alternately</p>		<p>RP1 RP2</p>
<p>Sequential</p> <p>4. Different switching points for the relays for turning ON and OFF</p> <p>$R_x-RP1 < R_x-RP2$</p> <p>Filling with energized relay</p>		<p>RP1 RP2</p>

OPERATING MODE	FUNCTION	PROG. PAR
<p>Sequential</p> <p>5. Different switching points for turning ON and same switching points for turning OFF for the relays</p> <p>$R_x-RP1 < R_x-RP2$</p> <p>Filling with energized relay</p>		
<p>Sequential</p> <p>6. Different switching points for turning ON and same switching points for turning OFF for the relays</p> <p>$R_x-RP1 < R_x-RP2$</p> <p>Filling with energized relay In case of x (x=2..8) relays, relays are operating alternately</p>		<p>RP1 RP2</p>

5.7.3.3 Configuring Parameters

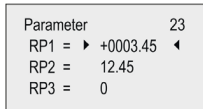
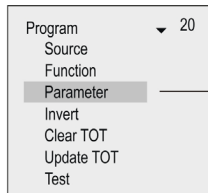

- ▶ ◀ Parameter to be edited
- ⊕ ⊖ Selection of digit position
- ⊕ ⊖ Modifying sing and number
- ESC For RP1 steps back to „Programming“ sub-menu, for RP2 and RP3 steps back to the previous parameter
- OK Accepts parameter change and steps to the next, pressing for RP3, values of RP1...RP3 are loaded to the memory and steps back to „Programming“ sub-menu

5.7.3.4 Inversion

The operation of the relay can be inverted by switching on the inverter. Default: Off

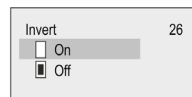

- Not selected
- Selected
- Selected using ⊕
- Selected choice gets applied immediately

5.7.3.5 Deleting TOT

Quantity (TOT1 and TOT2) summation is done in the flow-measuring transmitters. In the MultiCONT it is possible to transmit the TOT2 in preset units in the form of relay impulses. In order to do this, the relay has to be switched to 'Impulse F' mode. In the 'RP3' parameter (belonging to the relay), specify the volume that will trigger 1 impulse (the length of 1 impulse is about 200 ms). There is a 'PULSE' and a 'TOTAL' variable for each relay programmed to work in 'Impulse F' mode. The 'TOTAL' variable of the relay goes after the 'TOT2' variable of the transmitter. The volume difference between the 2 variables, given in 'RP3' is put into the 'PULSE' variable.

The value in the 'PULSE' variable is transmitted to the output of the relay. The 'TOTAL' and 'PULSE' relay variables get into the "non-volatile" memory even in the event of a power failure, as a result of the (automatic) saving done every 6 minutes. The relay impulses that occur in the time elapse between the last save and the return of power get counted again after the power supply is turned on. In order to avoid repeated counting, use a UPS.

Example: Let the TOT2 value of the transmitter be 1000 m³. Let the TOTAL value of the relay also be 1000 m³. Let the PULSE value of the relay be 0. At the same time, assume the RP3 parameter of the relay to be 10 m³. In this case, no impulses appear at the relay output, because the TOT2 value of the transmitter is the same as the TOTAL value of the relay. Based on the measurement of the transmitter the TOT2 value changes from 1000 m³ to 1050 m³, the change being 50 m³. Also, based on the RP3 parameter of the relay (10 m³ unit volume), 5 is added to the value of the PULSE variable, with the change being 5*10=50 m³. The relay then counts 5 impulses. After this, the value of the relay's PULSE becomes 0, while that of TOTAL becomes 1050 m³.

Once in this menu, pressing 'OK' will delete the values of the relay's 'TOTAL' and 'PULSE' variables. This results in the total volume in the transmitter's 'TOT2' variable to be counted to the output of the relay based on the unit set in the 'RP3'.

The delete operation is followed by the window below.



5.7.3.6 Refreshing TOT

Once in the menu, pressing 'OK' will copy the transmitter's 'TOT2' value into the relay's 'TOTAL' variable, and then delete the contents of the relay's 'PULSE'.

The transmitter and the MultiCONT become synchronised. The update operation is followed by the window below.



5.7.3.7 Testing



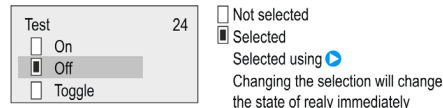

Relay operation is tested as seen below.

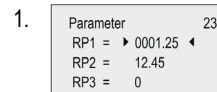

In "toggle" mode, pressing  causes the state of the relay to switch.

Note:



To program the parameter select the relevant parameter in Main menu/Relays/Relay/Program/Parameter using the  and  buttons, enter the value in between the pointers and press . Programming can only be completed by pressing  after setting RP3 (even if it is zero or not applicable in the given function!)

- Inactive relays are de-energized (See: Main menu/**Relays**).
- More than one device can be assigned to any of the relays (Main menu/Relays/Program/Source)
- The result will be the mathematical combination of the sources.
If the measurement mode or dimensions of devices are different MultiCONT will send error message (See 6. Errors, Error messages)
The result of the transmitters marked with \oplus are added.
The result of the transmitters marked with \ominus is subtracted from the sum of the result of the transmitters marked with \oplus .

Computes the average of the results of the transmitters marked with \square .

- If the **Error** function is selected no (source) assignment is required since errors of all active devices will be monitored
- Relay state will not be changed (HOLD) if its assigned source does not reply!
- The device will indicate program error if:
 - There are multiple sources with different dimensions
 - „Impulse F” function is selected, and there are multiple sources or RP3=0
 - „Alt S” or Sequential function is selected, and more than 8 relays are assigned to one device or the sources are different (e.g.: PV for 1 relay, and SV for another)
 - The sources are SV, TV, and QV but the COM3 command is not selected
 - ALARM, G function is selected and dimensions of the transmitters’ measurement values are different

For a detailed overview of the Programming see Appendix 3.

5.8 OPERATION AND PARAMETERS OF CURRENT OUTPUTS

First of all, a **device should be assigned to the current output** (Main menu / Current outputs / Program / **Source**).

The result of the transmitters marked with \oplus are added.

The result of the transmitters marked with \ominus is subtracted from the sum of the result of the transmitters marked with \oplus (difference measurement)

Computes the average of the results of the transmitters marked with \square .

Secondly the relevant **function should be selected and configured** in (Main menu / Current outputs / Program / **Function**). Finally, the parameters have to be programmed such that the values of the dimensions of CP1 and CP2 be determined by the transmitter(s). Thus, if the measurement mode is LEVEL [m] (e.g., for SE-300 P01=x1 P00=00x), then the programming has to be in LEVEL [m] too (Main menu / Current outputs / Program / **Parameter**).

For a detailed overview of the programming steps see **Appendix 4**.

5.8.1 Selection of current outputs

It is impossible to enter the current output menu if the system does not contain a single current output. The number of relays in the system can be viewed under Main menu / MultiCONT config / Report. (See chapter 5.4.12)

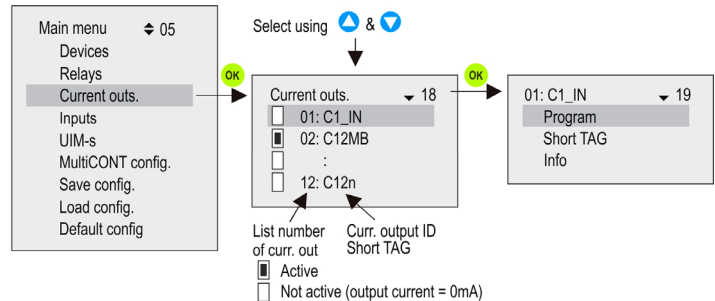

5.8.2 Properties of the selected current output

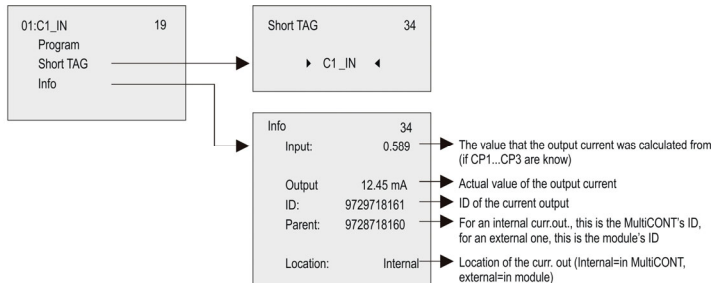

5.8.3 Current output programming

5.8.3.1 Source Selection

One or more devices can be assigned to a single current output.

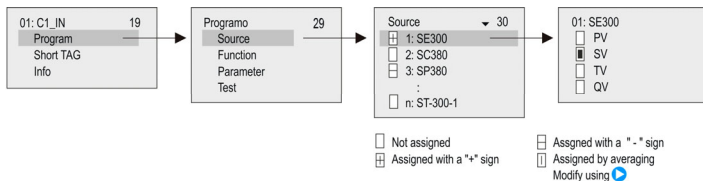

In the above example, current output C1_IN is controlled by the difference between the secondary values of SE300 and SP380. In the case of a single unit, the sign is indifferent; in fact, average might as well be selected. In the case of the selection of multiple devices, functioning depends on the result of the mathematical sum. If in the case of selected multiple devices the dimensions or the values are different, the unit will display an error message. Upon selecting the value, confirm that the appropriate HART command has been selected for the device (See Main menu / MultiCONT config / HART / command set, see chapter 5.4.5.5)

5.8.3.2 Function

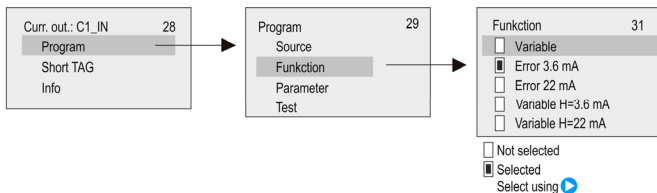

FUNCTION	DESCRIPTION OF OPERATION	PROG. PAR.
Variable	Operates in accordance to the selected (PV, SV, TV, QV) value in the "Source" menu point. The value in CP1 parameter is assigned to 4mA, the value in CP2 parameter is assigned to 20mA.	CP1 CP2
Error 3.6mA	CP3=0 in every cases it is the error current	CP3
Error 22mA	CP3=n in case of "n" coded error it is the error current Error codes (see chapter 6) If there is no error, value of the current output is 4mA	
Variable H=3.6 mA	The previous two functions in one:	CP1 CP2 CP3
Variable H=22 mA	Until there is no error, it works according to the selected (PV, SV, TV, QV) value in the "Source" menu point. The value in CP1 parameter is assigned to 4mA, the value in CP2 parameter is assigned to 20mA. In case of any error, selected error current will be applied.	

Note:

- The device will display an error if the selected mode is "Variable" and CP1=CP2
- Value of the output current will not change (HOLD), if the assigned device does not respond or responds with an "Err xx" error!
- If the current output is not active the output will be 0 mA.
- If the **Error** function is selected, then no **Source** assignment is required since errors of all active devices will be monitored
- The modified parameters can only be saved when the cursor is on CP3 by pressing **OK**.

5.8.3.3 Parameter Configuration

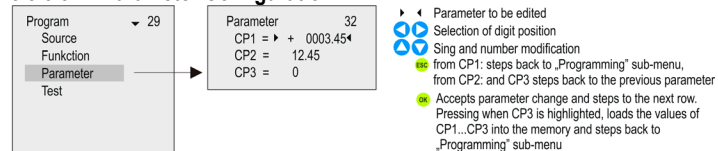

5.8.3.4 Testing

The current output can be tested in steps of 1µA. Upon changing the numbers, the output changes immediately, and it is not necessary to press OK.



5.9 THE BOOT PROCESS

At every powering on, a test program runs testing the MultiCONT hardware. The whole process can be followed on the display in English. The procedure takes about 40s.

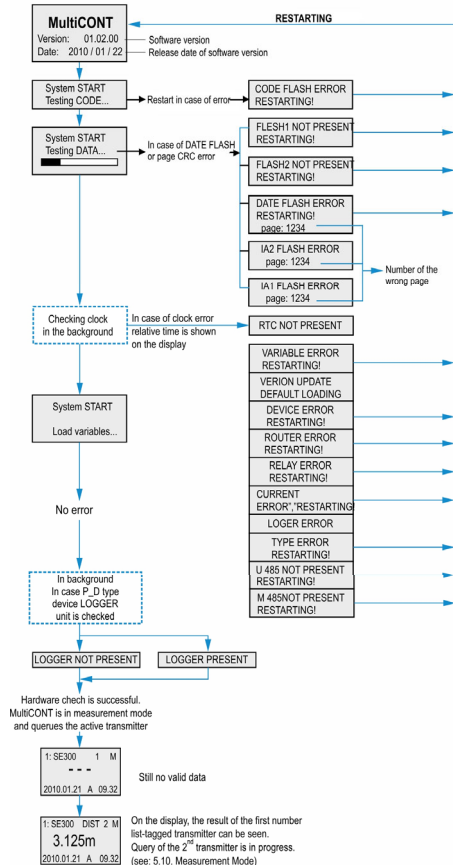

5.10 MEASUREMENT MODES

After the boot test the MultiCONT will automatically enter the Measurement Mode / standard display image. Measurement values will be queried and displayed in accordance with the contents of the device list read from the memory and the settings in **Main menu / MultiCONT config / Main display / Step**. Maximum 5 data per device can be displayed simultaneously on the display (1 main display – see 5.4.3 - and 4 on the list display – see 5.4.4) together with dimensions and abbreviations (DIST, LEV, VOL, FLOW, PV, SV, TV, QV, TOT1, TOT2, E). In the upper row the device identifier (Short TAG), List Tag (1,...9,A,...F) can be seen and the device communicating actually with the MultiCONT. When the device communicates via RS485, the “*” flashes. There are two bar graphs on the display. One is the “sensor range” (only for NIVELCO transmitters), this indicates the transmitter’s measurement range (the tank level between the maximum and minimum measuring distance). The other is the “output range” that indicates the 4...20mA range of the transmitter.

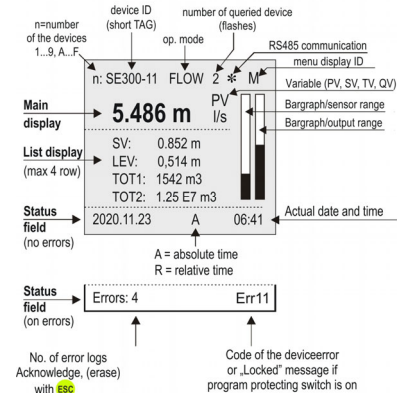

In this mode, it is possible to view the “Bar graph display”, the “User display” (Range, Double, Difference, Average see **Main menu / MultiCONT config / User display** - chapter 5.4) selected by the user, the relay-device and current output-device assignments, and also the error list, using and for selection. (See Appendix 5)

After the termination of a possible error, the display keeps on displaying the error until the error is acknowledged by pressing the **ESC** button. The query of the devices, the control of the relays and the current outputs and the servicing of the RS485 all happen continuously during programming. The MultiCONT automatically returns to measurement mode 5 minutes after the last button was pressed. It also records and saves the number of switching's and worktime of the relays every 6 minutes. The 6 minutes commence after the automatic exit.

5.11 MULTICONT SAVING AND LOADING SETTINGS

Settings of the MultiCONT are stored in a non-volatile FLASH memory (**FMA**). The content of this FLASH memory is replaced into the operative memory (**OM**) (which is a volatile memory) when MultiCONT is turned ON or restarted. Settings are saved automatically when exiting from the Menu.

In addition to this, working hours and the switching number of the relays are saved in every 6 minutes into the FLASH memory. In the "Main menu"/"Save config." menu point a safety copy (**FMS**) can be made from the automatically saved settings.

Load of the safety copy can be performed in the "Main menu"/"Load config." menu point. When turning ON or restarting, memory content is replaced into the operative memory from the FLASH memory, if it is faultless (calculated and stored CRC are the same). If there is a safety copy from the settings, the content of this (**FMS**) is copied to the operative memory (**OM**) and the automatic saving storage (**FMA**) FLASH memory, when **ESC** and **▶** buttons are pressed simultaneously.

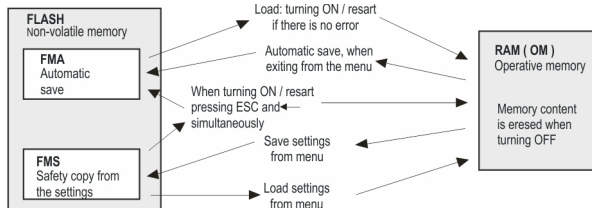

6. ERROR CODES

In the event of an error, the message "**errors**" (see Measurement mode, appendix 5) immediately appears regardless of which device the error is connected to. Errors occurring during operation will be collected in the **E (Error)** table where the error identifier message can be viewed.

Errors	E
01: SE300-11 : Response	
02: ST300-11 : Program	
03: SP300-11 : Device	

"**Sensor**" and "**Reply**" error message will automatically be erased from the list upon termination of the error.

Other errors entries will remain in the table until acknowledgement by pressing **ESC**. Thus, for instance if a relay or current output set for function "Error", it will indicate the error even after termination of the error until the error is acknowledged as above.

ERROR CODE	MESSAGE	ERROR DESCRIPTION	CORRECTION
1	Init	Device does not reply after switching-on*	Check wiring of device
2	Reply	Device with normal operation does not respond **	Check wiring of device
3	Sensor	Sensor failure on the device ***	Check device (transmitter)
4	Device	Other device Error (See chart next page)	Check programming of device (See relevant Install and Prog. Manual), and measurement conditions
5	Program	Error occurred during programming of relay or current output ****	Check programming
6	Save	Error occurred in the course of saving to memory	If this happens repeatedly, send device to the manufacturer.
7	Log	Logging does not answer or a failure may happen during the saving process	Please check the memory card, if necessary, try with another SD card.

* An active device on the list does not reply after switching-on. Possible reasons:

- the system was modified before turning on (device was disconnected, the wiring was changed, etc.)
- device failed to reach operation conditions during the boot process (and is not yet able to measure) thus this error message appears (e.g., in solid applications, STD-300 transmitters may not respond until the amplification reaches operation conditions).

** A device that had been working perfectly suddenly stops responding. Possible reasons:

- the device has gone wrong
- broken cable
- noisy HART line (See Main menu/MultiCONT config/HART test)

*** A special error message belongs to sensor failures. This error can appear in the case of ultrasonic transmitters due to the breakdown of the transducer or during a dusty filling process, when if there is a display, a NoEcho message is displayed. In case of magnetostrictive transmitters, this error can be due to the cracking of the magnet disc, or a break in the magnetostrictive wire.

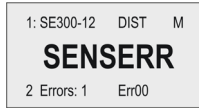

Device responds but there is no valid result because of sensor error.

**** Programming error will be caused if:

- assignment of more than one source with different dimensions to a relay or current output
 - an appropriate value (PV, SV, etc.) is assigned to a current output and CP1=CP2 (see 5.8 Operation and parameters of current outputs)
 - assignment of flow value (Impulse F) to a relay and there is more than one source (see 5.7 Relay configuration)
 - assignment of flow value (Impulse F) to a relay and RP3=0 (see 5.7 Relay configuration)
 - more than 8 relays with „Alt S” or Sequential function are assigned to a transmitter
 - different variables are selected in the case of a relay with „Alt R” function
 - the source is SV, TV or QV, but the COM3 HART command is not selected
- ALARM, G function is selected, but the dimensions of the measured values are not the same

7. HARDWARE PROTECTION OF SETTINGS

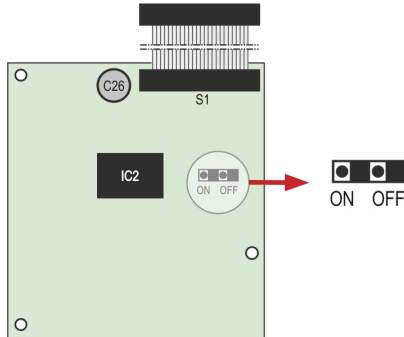

For access, loosen the nuts fastening the front panel.

The program protection switch in ON position will prevent modification of parameters affecting operation such as.

- relay parameters
- current output parameters
- activation of devices
- remote programming
- denying access to the **Service** menu
- denying permission to run **DEV detect**, **EXT detect** under MultiCONT config.

The switch does not prevent modifications that do not influence the operation of the MultiCONT (such as language, backlight, user image, sorting, restart, etc.).

8. FUSE REPLACEMENT

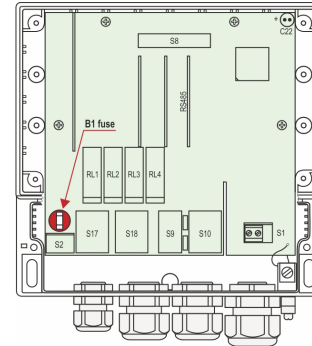

In order to change the fuse, loosen four nuts fastening the front panel, carefully tilt the front panel forward, such that the cable band is not under tension and replace the fuse.

Warning! Only use fuses specified in the table below.

POWER SUPPLY	FUSE B1
85...255 VAC 50...60 Hz	T400mA
11,4...28 VAC 50...60 Hz	T1A
11,4...40 VDC	

The device contains 1 network fuse. Its value depends on the power supply.

9. SERVICING

9.1 BOX MESSAGES

No.	Box Message	Explanation
1	No CODE!	Secret code is not set
2	In manual prg!	The transmitter is under manual programming
4	Already unlocked!	No code in the transmitter (i.e. 00000000)
5	Unlock, please!	Secret code needed for modification (see."Main menu"/"MultiCONT config.)/"password")
6	HART error!	Communication error
7	TOT1 cleared!	Value of TOT1 deleted
8	TOT2 cleared!	Value of TOT2 deleted
9	HART no reply	During programming the device does not respond, or bad data
10*	HART comm. error	Error in HART message (parity, framing, overflow, ...)
11*	HART logical error	Other logical error in HART message
12*	HART write protect	The parameter cannot be written
13	Unknown dev/comm	The address (Long address) in the HART message is not found in the list
14	Parameter saved	Successful save of the parameter
15	Save error	Error in writing to FLASH memory
16	Device added	The selected device in the „Device detect” menu has been included into the list.
18	Unknown param.	Unknown parameter during device detection
19	Default loaded	Loading of Factory default (depending on type) was successful.
20	PSW cleared	Secret code is deleted
23	FLASH error	FLASH error at boot
24	Same address!	Multiple same Long address found during DEV detect
25	No HART device	In the „Device detect” menu, searched for devices with „Short addr.” between 0..15 but did not find any
26	Load error	Error when reading from FLASH memory
28	No comp. Device	Device is not NIVELCO compatible
30	HART:Parse error	The received data are not applicable
31	HART:Invalid sel.	The received HART command is unknown to the MultiCONT
32	HART:Too large	The received HART command is longer than standard

No.	Box Message	Explanation
33	HART:Too small	The received HART command is shorter than standard
34	HART:Few data	
35	HART:Device spec.	Bad parameter sent during remote programming
36	HART:Acces restr.	
37	HART:Busy	
38	HART:Comm. not. imp.	The received HART command is unknown to the MultiCONT
39	Please wait!	DEV detect cannot run due to periodic disturbance on the HART line, which causes continuous error!
40	TOT cleared	TOT deleted during relay programming (Impulse F)
41	TOT updated	TOT updated during relay programming (Impulse F)
42	No in RP mode	Device could not enter „Remote programming” (RP) mode during programming
43	Stick in RP mode	Unsuccessful exit after remote programming of device

9.2 OTHER MESSAGES

No.	Message	Explanation
1	Scanning HART line	Displayed during device detection
2	Logical error	<ul style="list-style-type: none"> • Displayed instead of user’s image, if difference or average is selected, but there is only one active device • Displayed if the dimensions of the results of the selected devices are different
3	No user screen	In „Main menu”/”MultiCONT config.”/”User display” „None” is selected
4	No active device	<ul style="list-style-type: none"> • Displayed during measurement or instead of user’s image, when there is no active device
5	No HART device	The unit’s device list is empty (run „DEV detect”)
6	Locked	The hardware switch is on (the program cannot be modified)
7	No current output	Displayed in the position of the „current output assignment” image, if there is no current output in the system
8	No relay output	Displayed in the position of the „Relay assignment” image, if there is no relay in the system

9.3 TROUBLESHOOTING

9.3.1 It is impossible to enter the „Main menu”/”Relays” or „Main menu”/„Current outputs” menu

There is no relay or current output in the unit. Check the number of relays and/or current outputs in „Main menu”/”MultiCONT config.”/”report” menu.

9.3.2 It is impossible to enter the „Main menu”/”Devices” menu

The device list is empty. (there are neither inactive, nor active devices in the system, in measurement mode a „No HART Device” message appears on the display.)

9.3.3 A „Please wait” message appears upon selecting „DEV detect”

The HART line is so noisy, that there is no communication, and every command is bad. The only way to exit this state is by switching the unit off and on again. Check the shielding of the cable and the cable route.

9.3.4 The result of „DEV detect” is the „No device” message

The MultiCONT did not detect any device that responded.

- Check for short-circuits or open-circuits.

There is a short-circuit if there is voltage between L+ and SH, but between L+ and L- the voltage is 0V.

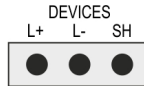

- The line is open-circuited (cut) if there is no voltage between L- and SH, because there is no voltage drop on the sensing resistor ($R_{\text{R}} = 255 \Omega$) connected between these 2 points, whereas the loop current should never be 0mA.
- Check the terminal voltage at the devices (transmitters). If the terminal voltage is small, it might be due to bad wiring (big intermediate resistance) or big loop current, resulting on a big voltage drop on the sensing resistor. Connect the devices in to the loop one by one, checking the „Short address” and the constant current parameter (see: chapter on preparation of transmitters)
- Confirm that the device is HART capable (Type, nameplate)

9.3.5 The unit does not start up when switched on

It restarts repeatedly (see: chapter 5.9.)

- This can be due to faulty FLASH (the non-volatile memory in the unit)
- Or a bad RS485 card (types P__-1_A and P__-1_B), because this is tested at boot, and does not continue in case of an error. Request help from our Export Sales department.

9.3.6 The „Response” error entry is too frequent

The line is noisy, check the grounding of the cable shielding. If the cable is not shielded, replace it with a shielded cable.

9.4 ADDITIONAL INFORMATION

9.4.1 Problems that may occur during remote programming

In the case of integer type parameters, MultiCONT displays all the four digits even if the case of a given transmitter only one digit is meaningful. For example:

PRW: P12 Error state 14
▶ 0002 ◀

SE-300: P12: 2

SE-300 only tests the value of digit „a” value (see Manual), and does not display an error if 1002 is written. It even stores this value. It does not indicate any operational error, but upon reading this parameter from SE-300 1002 is received which does not have any meaning according to the manual!!!!

9.4.2 MultiCONT transmits the parameters without examining them, and the testing is done by the device.

In the event of an error, if the device does not accept it, then a “HART logical error” box message appears on the display.

9.4.3 Use of Second HART Master (Hand-Held or HART modem + EView2 configuration software)

Normally, there can only be one master in HART systems. Since the MultiCONT is a master, other masters can only be used if the status of every device is set to inactive, i.e., the MultiCONT is in listen mode. (see „Main menu”/“Devices”) After this, the other master can be connected to the L- and SH terminals (with a 255 Ω sensing resistor inside).

9.4.4 Upon exiting remote programming, the unit tests to see if the transmitter really exited the remote programming mode

(During remote programming „RP” appears on the display of the transmitter). If this is not successful, then the „Stuck in RP mode” box message keeps us informed. In this case, it is not possible to manually enter programming mode!!

9.4.5 When a transmitter does not respond, then „Response” error is entered into the table, but upon termination of the error (the device responds), this entry is automatically cleared from the table (and does not need to be acknowledged)

This is also true for „Sensor” error (noEcho, etc.). The states of the relays and current outputs are not refreshed during this process!!!

9.4.6 Upon exiting the menu, MultiCONT immediately saves the modifications

However, there are events that need to be saved, and this happens every 6 minutes. These include:

- Work time and number of state changes of relays
- The number of times the MultiCONT was turned on (see: „Main menu”/“MultiCONT config.”/“Report”/“Power count”)
- The relevant internal variables, if the function of any relay is „Impulse F”, i.e., RP3 sends a unit pulse to the output, (TOTAL and PULSE, see: „Main menu”/“Relays”/“Programming”/“deleting TOT”)

9.4.7 The error list is cleared when the device is switched off

APPENDIX 1 – MANUFACTURER IDENTIFICATION CODES OF HART COMPATIBLE DEVICES

1	"Acromag",	38	"Rosemount",	75	"Termiflex Corporation",	112	"US ELECTRIC MOTORS",	139	"Thermo Electric Co.",
2	"Allen Bradley",	39	"Peek Measurement",	76	"VAF Instruments",	113	"Apparatebau Hundsbach",	140	"ISE-Magtech",
3	"Ametek",	40	"Schlumberger",	77	"Westlock Controls",	114	"Dynisco",	141	"Rueger",
4	"Analog Devices",	41	"Sensall",	78	"Dexelbrook",	115	"Spriano",	142	"Mettler Toledo",
5	"Elsag Bailey",	42	"Siemens",	79	"Saab Tank Control",	116	"Direct Measurement",	143	"Det-Tronics",
6	"Beckman",	43	"Weed",	80	"K-TEK",	117	"Klay Instruments",	144	"TN Technologies",
7	"Bell Microsensor",	44	"Toshiba",	81	"Flowdata",	118	"Action Instruments",	145	"DeZURIK",
8	"Bourns",	45	"Transmaton",	82	"Draeger",	119	"MMG Automatiky DTR",	146	"Phase Dynamics",
9	"Bristol Babcock",	46	"Rosemount Analytic",	83	"Raytek",	120	"Buerkert Fluid Control Systems",	147	"WELLTECH SHANGHAI",
10	"Brooks Instrument",	47	"Metso Automation",	84	"Siemens Milltronics PI",			148	"ENRAF",
11	"Chessel",	48	"Flowserve",	85	"BTG",	121	"AALIAN Process Mgt",	149	"4tech ASA",
12	"Combustion Engineering",	49	"Varec",	86	"Magnetrol",	122	"POUNDS INSTRUMENT",	150	"Brand Instruments",
13	"Daniel Industries",	50	"Viatran",	87	"Metso Automation",	123	"ZAP S.A. Ostrow Wielkopolski",	151	"NIVELCO",
14	"Delta",	51	"Delta/Weed",	88	"Milltronics",	124	"GLI",	152	"Camille Bauer",
15	"Dieterich Standard",	52	"Westinghouse",	89	"HELIOS",	125	"Fisher-Rosemount Performance Technologies",	153	"Metran",
16	"Dohrmann",	53	"Xomox",	90	"Anderson Instrument Company",	126	"Paper Machine Components",	154	"Milton Roy Co.",
17	"Endress & Hauser",	54	"Yamatake",			127	"LABOM",	155	"PMV",
18	"Elsag Bailey",	55	"Yokogawa",	91	"INOR",	128	"Danfoss",	156	"Turck",
19	"Fisher Controls",	56	"Nuovo Pignone",	92	"ROBERTSHAW",	129	"Turbo",	157	"Panametrics",
20	"Foxboro",	57	"Promac",	93	"PEPPERL+FUCHS",	130	"TOKYO KEISO",	158	"Stahl",
21	"Fuji",	58	"Exac Corporation",	94	"ACCUTECH",	131	"SMC",	159	"Analytical Technology Inc.",
22	"ABB Automation",	59	"Meggitt Mobrey",	95	"Flow Measurement",	132	"Status Instruments",	160	"Fieldbus International",
23	"Honeywell",	60	"Arcom Control System",	96	"KAMSTRUP",	133	"Huakong",	161	"BERTHOLD",
24	"ITT Barton",	61	"Princo",	97	"Knick",	134	"Duon Systems",	162	"InterCorr",
25	"Kay Ray/Sensall",	62	"Smar",	98	"VEGA",	135	"Vortek Instruments, LLC",	163	"China BRICONTE Co Ltd",
26	"ABB Automation",	63	"Foxboro Eckardt",	99	"MTS Systems Corp.",	136	"AG Crosby",	164	"Electron Machine",
27	"Leeds & Northrup",	64	"Measurement Technology",	100	"Oval",	137	"Action Instruments",	165	"Sierra Instruments",
28	"Leslie",	65	"Applied System Technologies",	101	"Masoneilan-Dresser",	138	"Keystone Controls",	166	"Fluid Components Intl",
29	"M-System Co.",			102	"BESTA",				
30	"Measurex",	66	"Samson",	103	"Ohmart",				
31	"Micro Motion",	67	"Sparling Instrumnets",	104	"Harold Beck and Sons",				
32	"Moore Industries",	68	"Fireye",	105	"Rittmeyer Instrumentation",				
33	"Moore Products",	69	"Krohne",	106	"Rossel Messtechnik",				
34	"Ohkura Electric",	70	"Betz",	107	"WIKA",				
35	"Paine",	71	"Druck",	108	"Bopp & Reuther Heinrichs",				
36	"Rochester Instrument Systems",	72	"SOR",	109	"PR Electronics",				
37	"Ronan",	73	"Elcon Instruments",	110	"Jordan Controls",				
		74	"EMCO",	111	"Valcom s.r.l.",				

prw210en2107p
January 2021.

*NIVELCO reserves the right to change anything
in this manual without notice!*

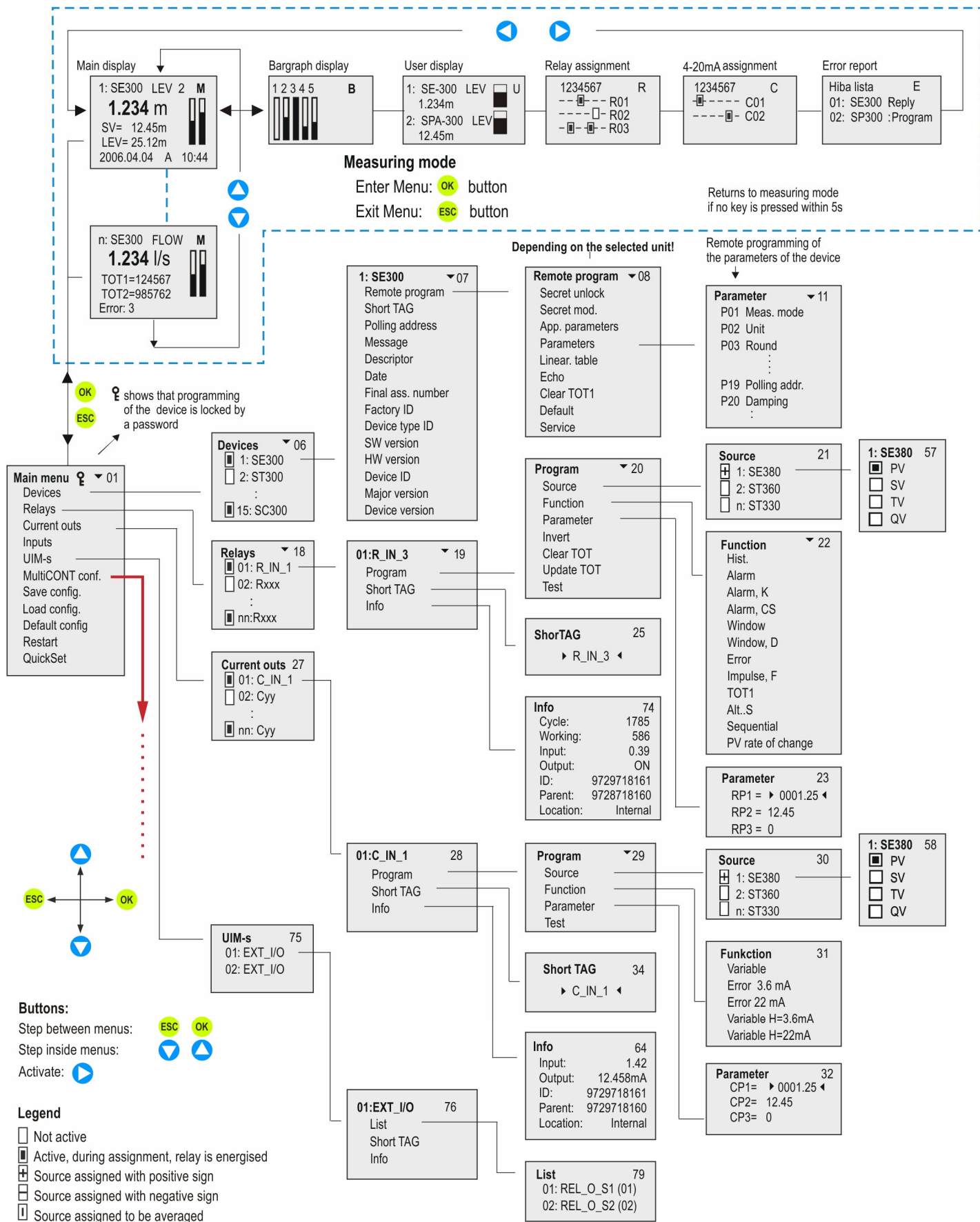

APPENDIX 2. – THE MENU SYSTEM OF THE MULTICONT P-200 (CONT.)

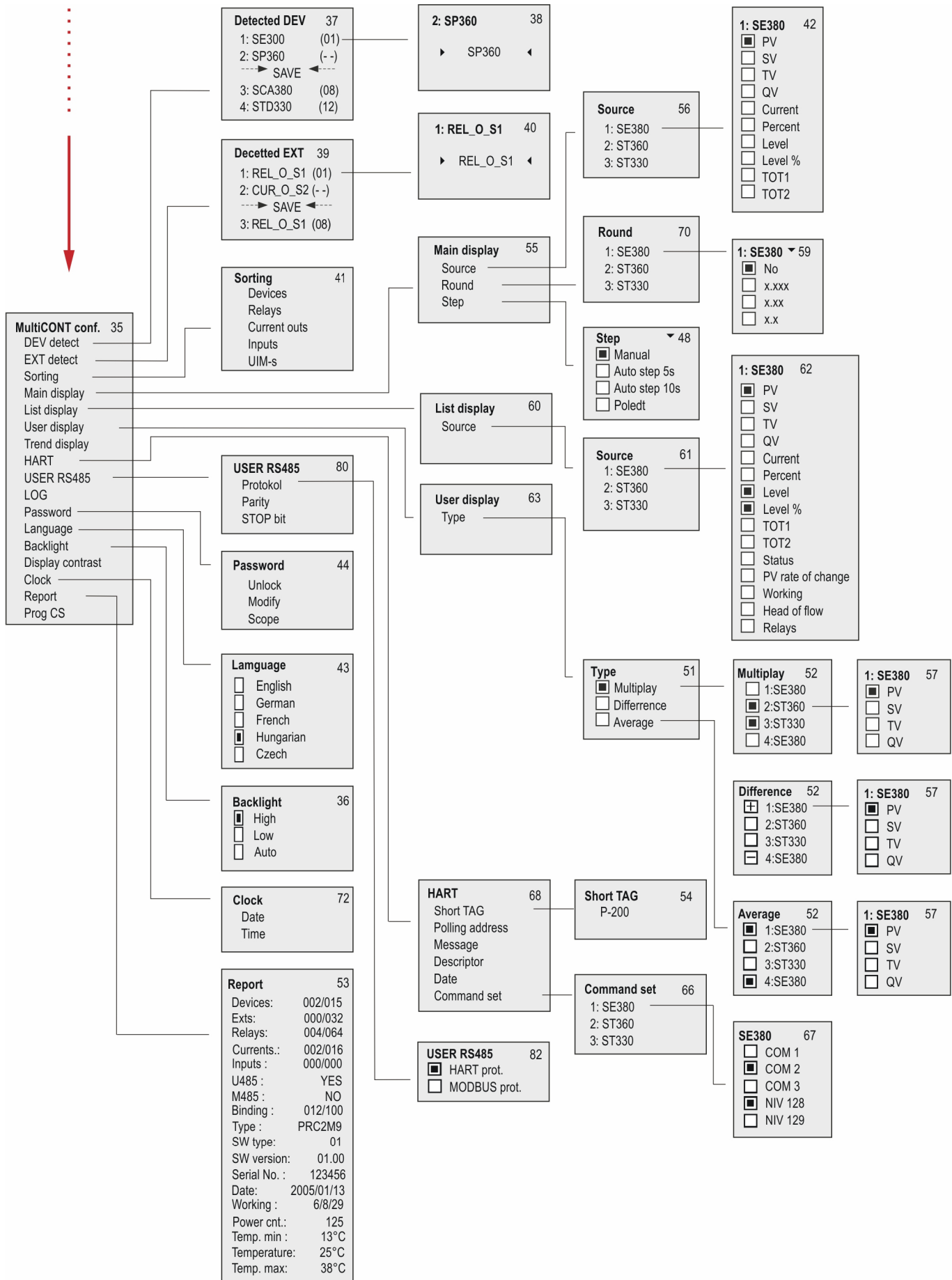

APPENDIX 3. – RELAY PROGRAMMING

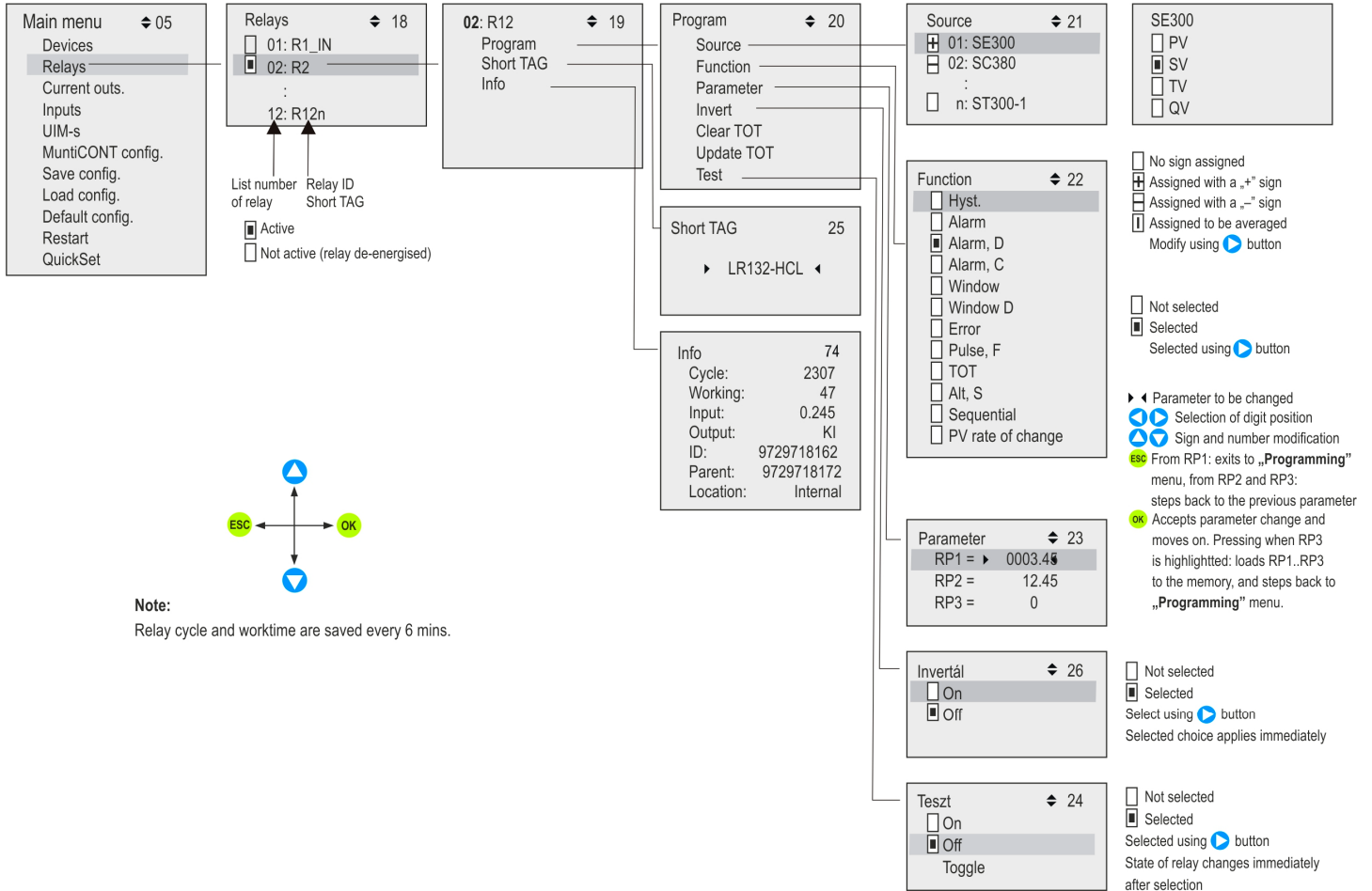

APPENDIX 4. – CURRENT OUTPUT PROGRAMMING

