

INSTRUCTION MANUAL



ULTRASONIC LEVEL METERS ULM-53

ULTRASONIC LEVEL SENSORS ULS-53



Before the first use of the level meter please read carefully the instructions provided in this User's Guide and keep it for future use. The manufacturer reserves the right to make changes without previous notice.

CONTENTS

| | |
|--|----|
| 1. Basic description | 4 |
| 2. Range of application | 5 |
| 3. Variants | 5 |
| 4. Dimensional drawing | 5 |
| 5. Installation and putting into operation | 6 |
| 6. Mechanical mounting | 6 |
| 7. Electrical connection | 10 |
| 7.1. Connection through ISO connector | 10 |
| 7.2. Connection through M12 connector | 11 |
| 7.3. Connection via standard cable gland or gland for protective hoses | 12 |
| 8. Control elements | 14 |
| 9. Settings | 15 |
| 9.1. Setting procedure for level meters ULM-53 | 15 |
| 9.2. Setting procedure for level sensors ULS-53 | 17 |
| 10. Function and status indication | 19 |
| 11. Protocol Modbus® | 20 |
| 12. Order code | 20 |
| 13. Correct specification examples | 21 |
| 14. Accessories | 21 |
| 15. Safety, protection, compatibility and explosion proof | 22 |
| 16. Use, manipulation and maintenance | 22 |
| 17. General conditions and warranty | 23 |
| 18. Marking of labels | 23 |
| 19. Technical specifications | 25 |
| 19. Packing, shipping and storage | 27 |

USED SYMBOLS

To ensure maximum safety of control processes, we have defined the following safety instructions and information. Each instruction is labelled with the appropriate pictogram.



Alert, warning, danger

This symbol informs you about particularly important instructions for installation and operation of equipment or dangerous situations that may occur during the installation and operation. Not observing these instructions may cause disturbance, damage or destruction of equipment or may cause injury.



Information

This symbol indicates particularly important characteristics of the device.



Note

This symbol indicates helpful additional information.

SAFETY



All operations described in this instruction manual have to be carried out by trained personnel or by an accredited person only. Warranty and post warranty service must be exclusively carried out by the manufacturer.

Improper use, installation or set-up of the sensor can lead to crashes in the application.

The manufacturer is not responsible for improper use, loss of work caused by either direct or indirect damage, and for expenses incurred at the time of installation or during the period of use of the level sensors.

1. BASIC DESCRIPTION

The **ULM® ultrasonic level meters** and the **ULS® ultrasonic level sensors** are compact measurement devices containing an electro-acoustic transducer and an electronic module. Using the electro-acoustic transducer, level meters and level sensors transmit a series of ultrasonic pulses that spread towards the surface. The transducer then receives the reflected acoustic wave, which is subsequently processed in the electronic module. The current distance to the surface level is calculated from the time of spread of individual pulses towards the surface and back and the temperature measured in the tank. The output is then set on the basis of the surface height.

The outputs of the ULM level meter are current 4 -20 mA, voltage 0 - 10 V and industrial line RS-485 with Modbus RTU communication. The output of the ULS sensor consists of a PNP transistor with an open collector and a two-state current switch 4 mA / 20 mA.

2. RANGE OF APPLICATION

Thanks to the contactless measuring principle ultrasonic level meters are suitable for continuous measurement or limit level sensing of liquids, waste water, sludge, suspensions, adhesives, resins in various open and closed vessels, sumps, open channels and drains. Use for organic solvents or substances, which contain organic solvents, should be consulted with the manufacturer. Usability for level measurement of solid materials is limited, there is a shorter measuring range. We recommend using the level meter for such a medium to consult with the manufacturer. Setting is carried out either using two buttons or a magnetic pen or by remote setting in case of Modbus RTU output. The device is equipped with optical indication of its state (RUN) and the setting process (STATE). It is manufactured in designs for normal (N) and explosive atmospheres (Xi).



In the case of use for an aggressive medium is necessary to prove the chemical compatibility of used materials of the sensor (Tab. Used materials on page 27). The guarantee ceases when the product is chemically damaged.

3. VARIANTS

- **UL_-53_-01_-** measurement range **0.1 m to 1 m**, all-plastic design, source of PVDF (polyvinylidene fluoride), mechanical connection with thread G ¾.
- **UL_-53_-02_-** measurement range **0.20 m to 2 m**, all-plastic design, source of PVDF, mechanical connection with thread G 1".
- **UL_-53_-06_-** measurement range **0.20 m to 6 m**, all-plastic design, source of PVDF, mechanical connection with thread G 1 ½".
- **UL_-53_-10_-** measurement range **0.4 m to 10 m**, all-plastic case, source of PVDF, mechanical connection with thread G 2 ¼".
- **UL_-53_-20_-** measurement range **0.5 m to 20 m**, all-plastic case, source of PVDF, mechanical connection with flange of aluminium alloy.

4. DIMENSIONAL DRAWING

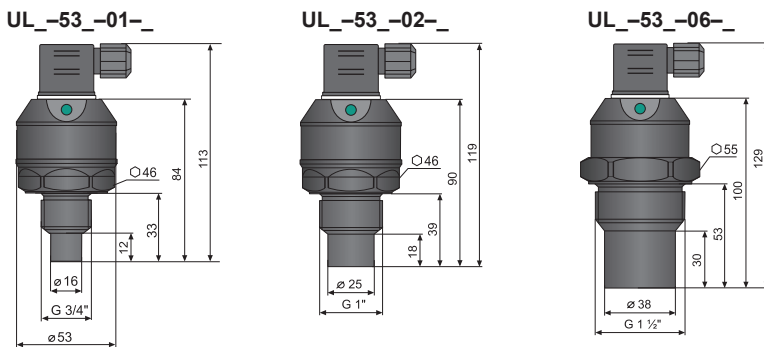

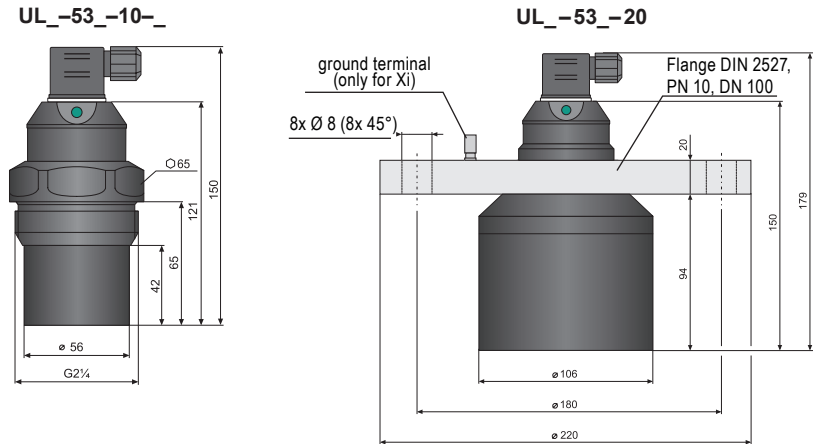

5. INSTALLATION AND PUTTING INTO OPERATION

Please follow next 3 steps:

- **MECHANICAL MOUNTING - SEE CHAPTER 6**
- **ELECTRICAL CONNECTION - SEE CHAPTER 7**
- **SETTING ELEMENTS - SEE CHAPTER 8**
- **SETTINGS - SEE CHAPTER 9**

6. MECHANICAL MOUNTING

- The device is installed in a vertical position into the upper lid of the tank or reservoir using a lug, a fastening nut or a flange in such a way that the axis of the device is perpendicular to the surface level of the measured liquid (Fig. 1). Tightening of the level meter in the welding flange (or. by the fixing nut) **must be done only by hand** *. The device shall be installed in places with no risk of **mechanical damage to the front of the sensor**.
- The minimum distance from the **tank wall** when installing into the lid or the ceiling of the tank are listed in Fig. 3. In the case of device installation close to smooth wall of the tank it is not necessary to observe the minimum distance, conversely it is suitable to shorten this distance.
- When installing in an open channel (sump, drain, etc.), install the device onto a console as close as possible to the expected maximum level.
- The reference plane for the measurement is the lower edge of the transducer (Fig.2). In compliance with the measuring principle, no signals **reflected in the area directly below the device** (dead zone) can be evaluated. The dead zone (Fig. 2) determines the minimum distance possible between the device and the highest level. The minimum distances to the medium are listed in the chapter "Technical specifications".
- The device shall be installed so that the surface does not interfere with the dead zone when the tank is filled to the maximum. If the measured surface interferes with the dead zone, the device **will not measure properly**.

*) To loosen the level meter can be used suitable wrench.

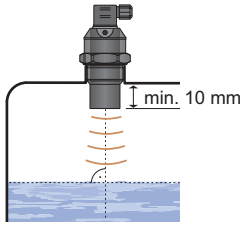

Fig. 1: Correct installation of the sensor, perpendicular to the liquid surface

| | |
|-------------------|-----------------------------|
| UL_–53–01; 02; 10 | $d > c/12$ (min. 200 mm) |
| UL_–53–06 | $d > c/8$ (min. 200 mm) |
| UL_–53–20 | $d > c/10$ (min. 200 mm) |

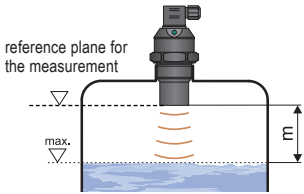

Fig. 2: Dead zone of the device

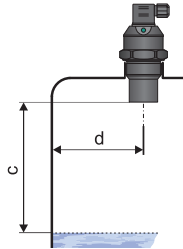

Fig. 3: Distance of the device from the tank wall

d – distance from tank wall
 c – maximum reach of the device
 m – dead zone

- Do not install the device in or above the **filling point** (Fig. 4). The measurement could be affected by the inflowing medium.

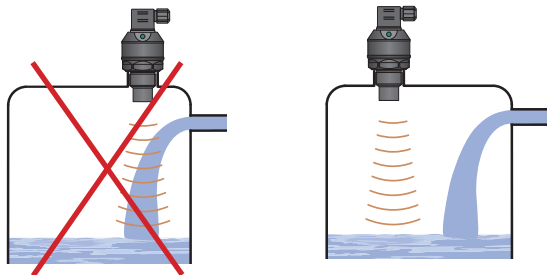

Fig. 4: Installation of the device out of reach of filling circulation



It is recommended to avoid placing the sensor into a narrow neck.

- Only if the maximum level in the tank gets into the dead zone, the device shall be mounted into a higher **installation neck**. The tank can be then filled nearly up to the maximum volume. The neck's inner surface shall be even and smooth (without edges and welded joints), the inner edge should be rounded in the spot where the ultrasonic wave leaves the pipe. Choose the largest possible neck diameter, but keep the neck height as low as possible. The recommended dimensions of the inlet neck are listed in Fig. 5.

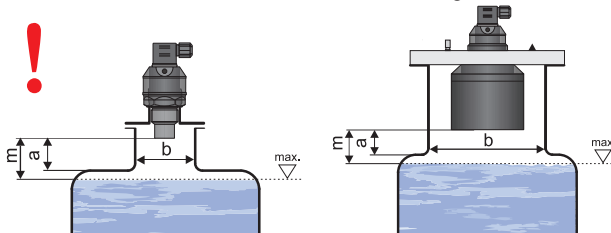

Fig. 5: Installation of the device in the installation neck

| | |
|-----------------------|------------------------------------|
| UL_–53–01; 02; 06; 10 | $a < 1.5b$ $b > 100 \text{ mm}$ |
| UL_–53–20 | $a < 1.5b$ $b > 150 \text{ mm}$ |

a – neck height from source edge
 b – neck width
 m – dead zone

- If the level sensor is mounted into narrow necks and into places with obstacles, close uneven walls or the filling area, where the transmission signal could be distorted, we recommend using a guide tube (acoustic horn). The tube must be made from a single material with a smooth inner surface (see image 6 a 7). The minimum tube diameter must have the dimension „h“ according to see to table at image 7. **The construction of the guide tube we recommend to consult with the manufacturer.**

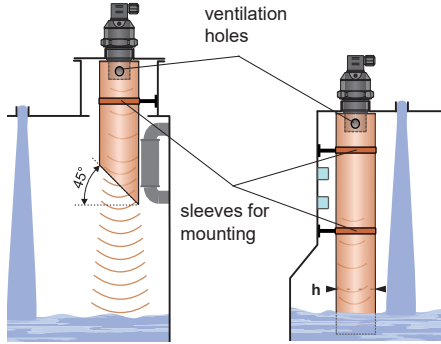

Fig. 6: Short guide tube installation

Fig. 7: Total guide tube installation

| | |
|------------|-----------------|
| UL_-53-01 | $h \geq 50$ mm |
| UL_-53-02 | $h \geq 70$ mm |
| UL_-53-06 | $h \geq 100$ mm |
| UL_-53-10 | $h \geq 150$ mm |
| UL_-53- 20 | $h \geq 200$ mm |

- Horn adapter** for improved reception of the transmitted signal can be used in open channels, sumps, tanks, etc. ST-G0,75 (G1, G1,5, G2,25) by type ULM.
- Horn adapter ST increases the directivity of the emitted acoustic waves, improves the reception of weak echoes (unstable surface level, loose materials, foam on the level) and reduces the risk of false reflections.
- The horn adapter is installed on the device via process connection G3/4" (ST-G0,75) or G1" (ST-G1) or G1½" (ST-G1,5), or G 2 ¼" (ST-G2,25).

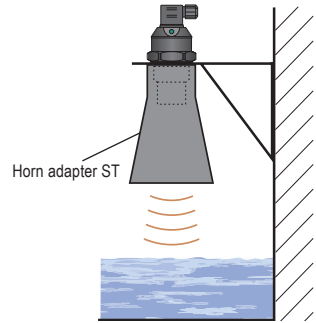

Fig. 8: Horn adapter installation

- The site for installing the level meter needs to be chosen so that the emitted acoustic signal is not affected by **nearby objects** (reinforcements, supports, brackets, ladders, heating elements, mixers, etc.). These obstacles may result in false rebounds, increasing measurement inaccuracy (Fig. 9).

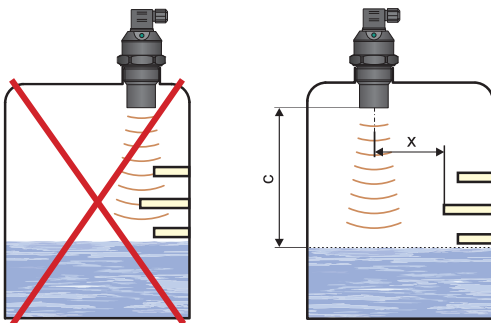

Fig. 9: Minimum distance from close objects in the tank

| | |
|-----------------|-----------------------------|
| UL_-53-01;02;10 | $x > c/12$ (min. 200 mm) |
| UL_-53-06 | $x > c/8$ (min. 200 mm) |
| UL_-53-20 | $x > c/10$ (min. 200 mm) |

x – distance from the edge of the longest object
c – maximum reach of the level meter

- **Foam** may be produced on the surface of the measured liquid during filling, mixing and other processes. The thick foam significantly absorbs the ultrasound signal and may cause malfunction of the device (Fig. 10). In those cases it is necessary to test the device in advance or contact the manufacturer. In case of a **thin layer of foam**, it is also possible to use directional **horn** for improving receipt of the reflected echo.

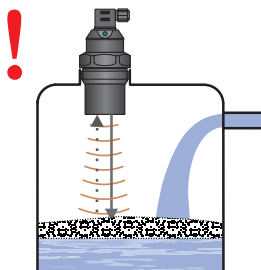

Fig. 10: Thick foam on the surface

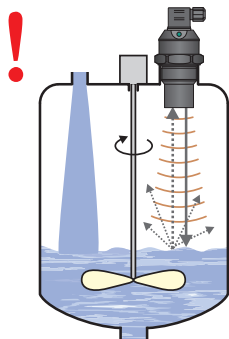

Fig. 11: Moderately stirred surface

- The ultrasonic signal can be scattered or attenuated if the surface is **moderately stirred** or **rippled** (due to a mixer, inflow of liquid, etc.). This may result in reduction of the measurement range or unreliable operation of the device (Fig. 11). For a **rippled** or **swirling level**, you can use the **directional horn** to eliminate scattering of the ultrasonic signal.

- False surface reflections of the ultrasonic signal and unreliable operation of the device might result from the mixer's **rotating blades** that ripple the surface level (Fig. 12).
- The device should not be installed in places with the risk of **false reflections** of the ultrasonic signal from the mixer's blades (Fig. 13).

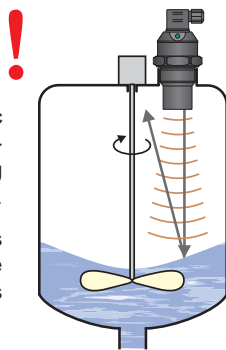

Fig. 12: Strongly stirred surface

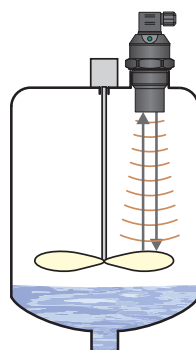

Fig. 13: False reflection from mixer blades

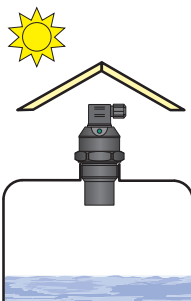

Fig. 14: Shielding cover against direct sunlight

- The measuring device **shall not be installed** in places with direct sunlight and shall be protected against weather conditions. **Direct sunlight affects the built-in temperature compensation!**
- If installation in places with direct sunlight is inevitable, it is necessary to mount a **shielding cover** above the device (Fig. 14).
- It is advisable to keep cable under the **cable gland** (sagging down) as shown in Fig. 15 to prevent penetration of moisture. Rain and condensing water can be therefore drained away freely.
- The cable gland as well as the connector shall be **tightened sufficiently** to prevent penetration of moisture.

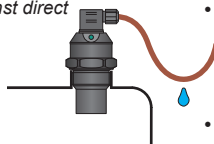

Fig. 15: Protection against penetration of moisture

7. ELECTRICAL CONNECTION

7.1. CONNECTION THROUGH ISO CONNECTOR

Valid for: UL_53_ _ _ _ _G_

The ULM level meter or ULS level sensor with a G type cable gland are connected to processing (display) units by means of a cable with an outer diameter of 6 to 8 mm (recommended wire cross-section 0.5 to 0.75 mm²), via a detachable ISO connector with inner screw terminals, which is part of the delivery. The connection diagram and the inner view of the connector are shown in Fig.16 and 17. Non-detachable connector IP67 with PVC cable 5 m long can be supplied as an extra option.

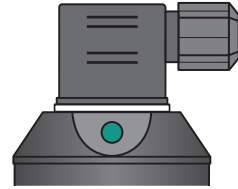

Performance „G“
with connector ISO

Connecting the cable to the device:

1. Unscrew the connector from the device body using a suitable screwdriver.
2. Remove the inner part of the connector using a flat screwdriver (insert the screwdriver in the gap marked with an arrow).
3. Unscrew the cable gland and pull the supply cable inside the connector.
4. Connect the cable wires to the screw terminals as shown in Fig. 16 (current output 4-20 mA), Fig. 17 (voltage output 0-10 V), Fig. 18 (S type output) or Fig. 19 (P) type output. Tighten the terminals firmly.
5. Insert the terminals back in the connector so that the NC terminal points away from the cable gland. Fasten the cable gland.
6. Check the sealing on the connector and attach the connector back to the device body.

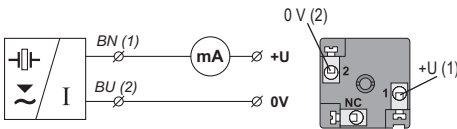

Fig. 16: Connection diagram of the ULM level meter (variant -I) and inside view of the connector

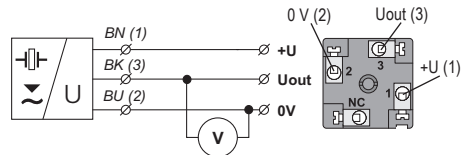

Fig. 17: Connection diagram of the ULM level meter (variant -U) and inside view of the connector

Type ULS-53_ _ _ _ _S-G_

Positive supply pole +U is connected to the brown wire or to connector pin 1, negative pole to the blue wire or to connector pin 2.

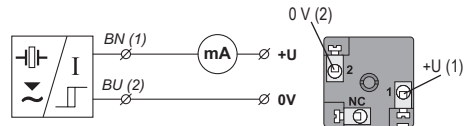

Fig. 18: Connection diagram of the ULS sensor with S type output (two-state current switch 4 mA / 20 mA)

Type **ULS-53_ _ _ _ -P-G_ _**

Positive supply pole +U is connected to the brown wire or to connector pin 1, negative pole to the blue wire or to connector pin 2. Load is connected to the black wire or to connector pin 3.

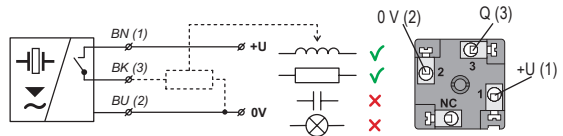

Fig. 19: Connection diagram of the ULS sensor with P type output (PNP) with an open collector

legend:

- BK – black BN – brown
- BU – blue NC – not connected

7.2. CONNECTION THROUGH M12 CONNECTOR

The ULM level meter or ULS level sensor with a C type cable gland are connected to processing (display) units by means of a cable with an outer diameter of 4 to 6 mm (recommended wire cross-section 0.5 to 0.75 mm²), via a connector socket with a moulded cable (2 or 5 m long) or via a detachable connector socket without a cable (see accessories), the connector is not basic part of the sensor. In this case connect the cable to the inner socket pins under Fig. 21.

Valid for: **UL_53_ _ _ _ -C_ _**

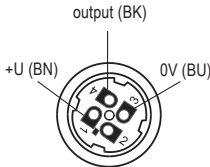
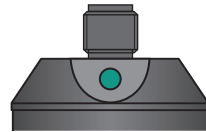

Fig. 20: Inside view of the connector socket

legend:

- BN – brown
- BK – black
- BU – blue



Performance, C⁴ with connector M12

Type **ULM-53_ _ _ _ -I-C_ _**

The positive supply pole +U is connected to connector pin 1 or the brown wire of the connected cable, the negative pole is connected to connector pin 3 or the blue wire of the connected cable.

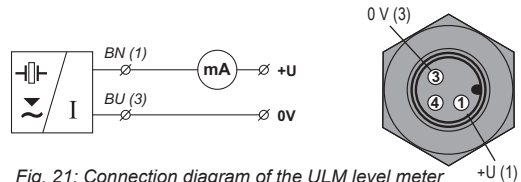

Fig. 21: Connection diagram of the ULM level meter (variant -I) and view of the connector

Type ULM-53 _ _ _ -U-C- _

The positive supply pole +U is connected to connector pin 1 or the brown wire of the connected cable, the negative pole is connected to connector pin 3 or the blue wire of the connected cable. Output voltage is connected to connector pin 4 or the black cable wire.

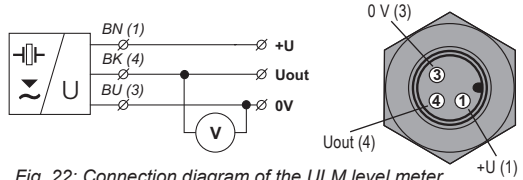

Fig. 22: Connection diagram of the ULM level meter (variant -U) and view of the connector

Type ULS-53 _ _ _ -S-C- _

The positive supply pole +U is connected to connector pin 1 or the brown wire of the connected cable, the negative pole is connected to connector pin 3 or the blue wire of the connected cable.

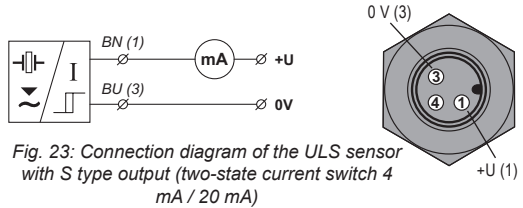

Fig. 23: Connection diagram of the ULS sensor with S type output (two-state current switch 4 mA / 20 mA)

Type ULS-53 _ _ _ -P-C- _

The positive supply pole +U is connected to connector pin 1 or the brown wire of the connected cable, the negative pole is connected to connector pin 3 or the blue wire of the connected cable. Load is connected to connector pin 4 or the black cable wire.

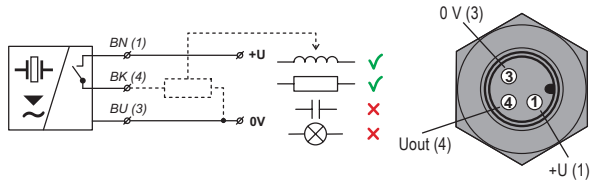

Fig. 24: Connection diagram of the ULS sensor with P type output (PNP) with an open collector

7.3. CONNECTION VIA STANDARD CABLE GLAND

OR GLAND FOR PROTECTIVE HOSES

Valid for: UL_-53 _ _ _ -B(H)-_

The ULM level meter or ULS sensor with a B or H type cable gland are connected to processing (display) units by means of a fixed PVC cable 5 m long. standard cable gland (B) or plastic bushings with a thread for protective hoses (H) can be used as a cable gland. Connection diagrams are shown in Fig. 25, 26, 27, 28 and 29.

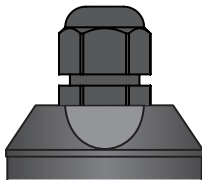

Performance „B“ with short cable gland

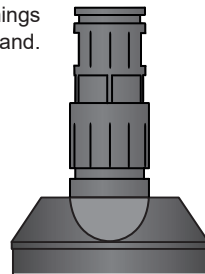

Performance „H“ with cable gland for protective hose

Type ULM-53 _ _ _ -I-B(H)- _

The positive supply pole +U is connected to the brown wire of the connected cable, the negative pole is connected to the blue wire of the connected cable.

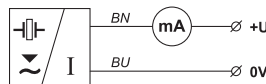

Fig. 25: Connection diagram of the ULM level meter (variant -I)

Type ULM-53-_-_-_-U-B(H)-_

The positive supply pole +U is connected to the brown wire of the connected cable, the negative pole is connected to the blue wire of the connected cable. Output voltage is connected to the black wire of the cable.

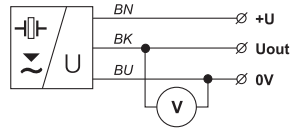

Fig. 26: Connection diagram of the ULM level meter with a voltage output (variant -U)

Type ULM-53-_-_-_-M-B(H)-_

Level meters are designed for connection to the PLC input (RS-485). The positive supply pole +U is connected to the brown wire of the connected cable, the negative pole is connected to the blue wire of the connected cable. Terminals A and B of line RS-485 are connected to the yellow and green communication wires. The ground terminal of line RS-485 is connected to cable shielding.

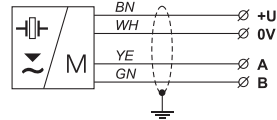

Fig. 27: Connection diagram of the level meter with an RS-485 output (variant -M)

Type ULS-53-_-_-_-S-B(H)-_

The positive supply pole +U is connected to the brown wire of the connected cable, the negative pole is connected to the blue wire of the connected cable.

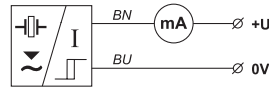

Fig. 28: Connection diagram of the ULS sensor with S type output (two-state current switch 4 mA / 20 mA)

Type ULS-53-_-_-_-P-B(H)-_

The positive supply pole +U is connected to the brown wire of the connected cable, the negative pole is connected to the blue wire of the connected cable. Load is connected to the black wire of the cable.

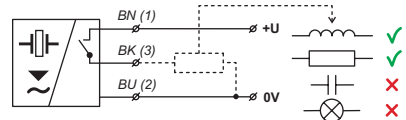

Fig. 29: Connection diagram of the ULS sensor with P type output (PNP) with an open collector

legend:

BK – black WH – white
 BU – blue YE – yellow
 BN – brown GN – green



Wiring operations shall only be carried out without voltage!

Taking into account the potential occurrence of electrostatic discharge on non-conducting parts of the level meter, it is necessary to ground the flange of level meters ULM-53Xi-20-F and sensors ULS-53Xi-20-F, located in an explosive atmosphere, using a ground terminal!



It is also necessary to design and take measures to reduce the effects of static electricity to a safe level in the wiring.

Installation in explosive atmospheres needs to be carried out in compliance with EN 60079-14 (Electrical installations for explosive gaseous atmospheres – Part 14: Electrical installations in dangerous areas other than mining) and possibly also in compliance with other standards relating to the area concerned.



The supply source should be preferably designed as a stabilized source of safe voltage 18 V to 36 VDC (max. 30 VDC for version Xi), which is part of the downstream processing or display system.

In case of strong ambient electromagnetic disturbance, parallel run of the input cable with the power line or its length exceeding 30 m, we recommend using a shielded cable.

8. CONTROL ELEMENTS

Device type with setting using buttons

DOWN button for ULM (or "**OFF**" for ULS)

- open the setting mode
- for ULM: direct setting of the value 4 mA (0 V)
- for ULS: setting limit for output disconnection
- decrease of values in defined steps

UP button for ULM (or "**ON**" for ULS)

- open the setting mode
- for ULM: direct setting of the value 20 mA (10 V)
- for ULS: setting limit for output connection
- increase of values in defined steps

Valid for: UL_-53_-_-_-_-_-T

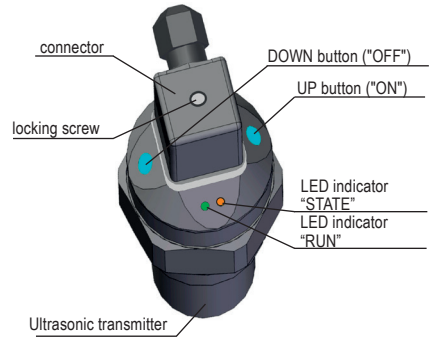

Fig. 30: Key parts of the measuring device (version with buttons)

Device type with setting using a magnetic pen

EMPTY flat area for ULM (or "**OFF**" for ULS)

- open the setting mode
- for ULM: direct setting of the value 4 mA (0 V)
- for ULS: setting limit for output disconnection

FULL flat area for ULM (or "**ON**" for ULS)

- open the setting mode
- for ULM: direct setting of the value 20 mA (10 V)
- for ULS: setting limit for output connection

Valid for: UL_-53_-_-_-_-_-M

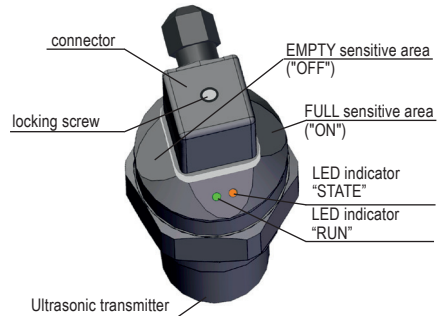

Fig. 31: Key parts of the measuring device (version with Hall probes)

9. SETTINGS

The level meter works most often in its default mode for level measurement (Fig. 32) and only rarely in the inverse mode (Fig. 33).

The manual device shall be set up after installation using the DOWN and UP buttons (for version "T") or by applying the magnetic pen onto sensitive flat areas (for version "M"). The set-up process is indicated by the STATE indicator lamp.

The L version level meter does not have any setting controls and indication LEDs. Pre-defined ranges are factory set (applicable to current and voltage outputs).

The level meter variant with a Modbus type output is set by means of two-way communication via the RS-485 industrial bus with the Modbus RTU protocol. A list of applicable registers is given in a separate appendix. To set up the level meter and collect measured data, you can use the software application „Basic SCADA level“, which is freely available at the Website www.dinel.cz.

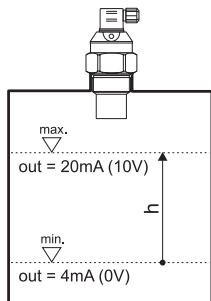

Fig. 32: Default mode
(level measurement)

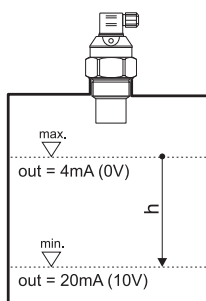

Fig. 33: Inverse mode

9.1. SETTING PROCEDURE FOR LEVEL METERS ULM-53

Connect the level meter to the supply source. Check the output value - current or voltage - using the measuring device or a connected instrument.

9.1.1. Setting using buttons (version "T")

a) Basic mode (level measurement)

Setting of lower limit 4 mA (0V)

1. Drain the tank to the lower measured level.
2. Press the DOWN button for at least 2 s to activate the setting mode (the STATE indicator LED flashes slowly). Keep the DOWN button pressed for at least additional 3 s to set the value to 4 mA (0V) directly. In that case you can skip step 3.
3. Press the DOWN and UP buttons to accurately set any value in individual increments (hold the relevant button to increase the adjustment step gradually).
4. Press both buttons simultaneously for at least 1 s to confirm the set values. The STATE indicator LED briefly flashes three times.
5. Any other setting is possible 2 s after both buttons are released.

Setting of upper limit 20 mA (10 V)

1. Fill the tank up to the upper measured level.
2. Press the UP button for at least 2 s to activate the setting mode (the STATE indicator LED flashes quickly). Keep the UP button pressed for at least additional 3 s to set the value to 20 mA (10 V) directly. In that case you can skip step 3.
3. Press the DOWN and UP buttons to accurately set any value in individual increments (hold the relevant button to increase the adjustment step gradually).
4. Press both buttons simultaneously for at least 1 s to confirm the set values. The STATE indicator LED briefly flashes three times.
5. Any other setting is possible 2 s after both buttons are released.

Default settings (factory default)

1. Disconnect the level meter from supply voltage (e.g. by disconnecting the connector).
2. Press the DOWN and UP buttons at the same time while supply voltage is disconnected.
3. Connect supply voltage while keeping the DOWN and UP buttons pressed.
4. Wait approx. 4 s for 3 short flashes of the orange STATE indicator LED. After that, release both buttons.
5. Now the level meter is set to factory default. See the table on page 26.

b) Inverse mode

In the inverse mode, set the lower limit of 4 mA (0 V) when the tank is filled up to the upper measured surface level and the upper limit of 20 mA (10 V) when the tank is drained to the lower measured surface level see Fig. 34.

9.1.2. Setting using a magnetic pen (version "M")

a) Basic mode (level measurement)

Setting of lower limit 4 mA (0 V)

6. Drain the tank to the lower measured level.
7. Set the level meter output to the value of 4 mA (0 V) by applying the magnetic pen to the EMPTY sensitive area for at least 2 s. The STATE indicator LED flashes slowly. Hold the magnetic pen on the flat area for at least additional 3 s to confirm the set value and store it in the internal memory of the level meter. The STATE indicator LED briefly flashes three times.
8. Any other setting is possible 2 s after the magnetic pen is removed from the sensitive area.

Setting of upper limit 20 mA (10 V)

1. Fill the tank up to the upper measured level.
2. Set the level meter output to the value of 20 mA (10 V) by applying the magnetic pen to the FULL sensitive area for at least 2 s. The STATE indicator LED flashes slowly. Hold the magnetic pen on the flat area for at least additional 3 s to confirm the set value and store it in the internal memory of the level meter. The STATE indicator LED briefly flashes three times.
3. Any other setting is possible 2 s after the magnetic pen is removed from the sensitive area.

Default settings (factory default)

1. Disconnect the level meter from supply voltage (e.g. by disconnecting the connector).
2. While there is no supply voltage, apply the magnetic pen on one of the sensitive areas.

3. Connect supply voltage and keep the magnetic pen in position.
4. Wait approx. 4 s for 3 short flashes of the orange STATE indicator LED. You can remove the magnetic pen.
5. Now the level meter is restored into factory default settings. See the table on page 26.

b) Inverse mode

In the inverse mode, set the lower limit of 4 mA (0 V) when the tank is filled up to the upper measured surface level and the upper limit of 20 mA (10 V) when the tank is drained to the lower measured surface level see Fig. 34.

9.2. SETTING PROCEDURE FOR LEVEL SENSORS ULS-53

The ULS-53 sensor can work in two modes:

a) Mode O (closed output when the maximum level is exceeded)

- the sensor output is closed when the level rises to the upper set point and open when the level drops to the lower set point

b) Mode C (open output when the maximum level is exceeded)

- the sensor output is open when the level rises to the upper set point and closed when the level drops to the lower set point

Connect the sensor to the power supply. Check the status of the sensor output - connected or disconnected - using a connected device.

9.2.1. Setting using buttons (version "T")

a) Mode O (closed output when the maximum level is exceeded)

Setting of open output

6. Drain the tank to the lower measured level.
7. Open the sensor output by pressing the OFF button for at least 2 s. The STATE indicator LED flashes slowly. Keep the OFF button pressed for at least additional 3 s to confirm the set value and store it in the internal memory of the level meter. The STATE indicator LED briefly flashes three times. You can also press both buttons simultaneously for at least 1 s to confirm the set values.
8. Any other setting is possible 2 s after the button is released (buttons are released).

Setting of closed output

1. Fill the tank up to the upper measured level.
2. Closed the sensor output by pressing the ON button for at least 2 s. The STATE indicator LED flashes quickly. Keep the ON button pressed for at least additional 3 s to confirm the set value and store it in the internal memory of the level meter. The STATE indicator LED briefly flashes three times. You can also press both buttons simultaneously for at least 1 s to confirm the set values.
3. Any other setting is possible 2 s after the button is released (buttons are released).

Default settings (factory default)

1. Disconnect the sensor from supply voltage (e.g. by disconnecting the connector).
2. Press the OFF and ON buttons at the same time while supply voltage is disconnected.
3. Connect supply voltage while keeping the OFF and ON buttons pressed.

4. Wait approx. 4 s for 3 short flashes of the orange STATE indicator LED. After that, release both buttons.
5. Now the level meter is restored into factory default settings. See the table on page 26.

b) Mode C (open output when the maximum level is exceeded)

In mode C, set the open status when the tank is filled up to the upper measured surface level and the closed status when the tank is drained to the lower measured surface level.

9.2.2. Setting using a magnetic pen (version "M")

a) Mode O (closed output when the maximum level is exceeded)

Setting of disconnected output

6. Drain the tank to the lower measured level.
7. Open the sensor output by placing the magnetic pen to the OFF sensitive area for at least 2 s. The STATE indicator LED flashes slowly. Hold the magnetic pen on the OFF flat area for at least additional 3 s to confirm the set value and store it in the internal memory of the level meter. The STATE indicator LED briefly flashes three times.
8. Any other setting is possible 2 s after the magnetic pen is removed from the sensitive area.

Setting of connected output

1. Fill the tank up to the upper measured level.
2. Closed the sensor output by placing the magnetic pen to the ON sensitive area for at least 2 s. The STATE indicator LED flashes quickly. Hold the magnetic pen on the ON flat area for at least additional 3 s to confirm the set value and store it in the internal memory of the level meter. The STATE indicator LED briefly flashes three times.
3. Any other setting is possible 2 s after the magnetic pen is removed from the sensitive area.

Default settings (factory default)

4. Disconnect the sensor from supply voltage (e.g. by disconnecting the connector).
5. While there is no supply voltage, place the magnetic pen on one of the sensitive areas.
6. Connect supply voltage and keep the magnetic pen in position.
7. Wait approx. 4 s for 3 short flashes of the yellow STATE indicator LED. After that, release both buttons.
8. Now the level meter is restored into factory default settings. See the table on page 26.

b) Mode C (open output when the maximum level is exceeded)

In mode C, set the open status when the tank is filled up to the upper measured surface level and the closed status when the tank is drained to the lower measured surface level.



If the surface level is within the dead zone (the RUN indicator LED flashes quickly), the setting mode is terminated immediately and will be inaccessible until the level leaves the dead zone.

If no button is pressed in the setting mode within 20 s, the measurement mode of the level meter will be restored. The newly set values will not be saved.

10. FUNCTION AND STATUS INDICATION

| LED indicator | Colour | Function |
|---------------|--------|--|
| „RUN“ | green | <p>short slow flashing – (repeated depending on the measurement interval approx. 1 ... 2 s) - correct function, receipt of signal (echo) reflected from the measured surface</p> <p>fast flashing – the measured surface is in the dead zone of the level meter or the ultrasound transducer is dirty.* This fault signal is triggered after 5 measurements in dead zone. After one measuring outside out the dead zone the fault signal cancels (LED stops flashing rapidly and the current / voltage is set to the current level)</p> <p>off – the level meter is not capable of receiving the echo. Incorrect installation or malfunction.* This fault signal runs after 20 lost echoes. After one correct measurement the led starts flashing again and the current / voltage is set to the current level)</p> <p>(* The dead zone and failure are also indicated by setting the output current/ voltage see fault on page 26.)</p> |
| „STATE“ | orange | <p>ULM-53</p> <p>Setting indication</p> <ul style="list-style-type: none"> • slow flashing – 4 mA (0V) threshold setting indication • fast flashing – 20 mA (10V) threshold setting indication • 3 short flashes – setting confirmation <p>ULS-53</p> <p>Output status indication</p> <ul style="list-style-type: none"> • off – sensor output is disconnected (OFF) • on – sensor output is connected (ON) <p>Setting indication</p> <ul style="list-style-type: none"> • slow flashing – setting indication for the disconnected status • fast flashing – setting indication for the connected status • 3 short flashes – setting confirmation |

11. PROTOCOL MODBUS®

Data communication takes place along a series line of a standard RS-485 with protocol Modbus RTU. A list of relevant variables is provided in a separate annex.

To set up the level meter and collect measured data, you can use the software application „Basic SCADA level“, which is freely available at the Website www.dinel.cz. Connecting the level meter to a peripheral device can be performed using a converter URC-485, see image 34.

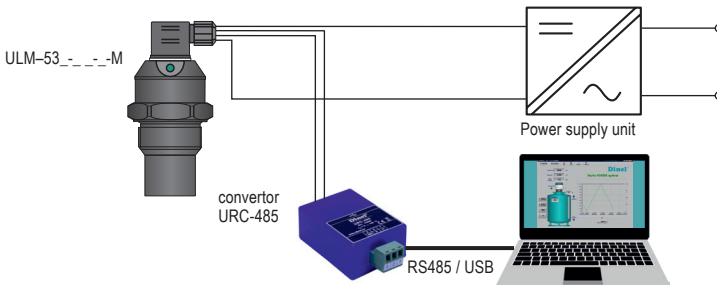



Fig. 34: Typical hardware configuration with Modbus®

12. ORDER CODE

| | |
|-------------------------------|--|
| PRODUCT | |
| UL | - 53 |
| TYPE | |
| M | continuous level meter, type of output P and S cannot be selected |
| S | limit level sensor, type of output I, U and M cannot be selected |
| MECHANICAL PERFORMANCE | |
| N | non-explosive atmosphere |
| Xi |  explosive atmosphere, only for type of output I |
| MAXIMUM RANGE | |
| 01 | 0,10 ... 1 m, process connection F cannot be selected |
| 02 | 0,20 ... 2 m, process connection F cannot be selected |
| 06 | 0,20 ... 6 m, process connection F cannot be selected |
| 10 | 0,40 ... 10 m, process connection F cannot be selected |
| 20 | 0,50 ... 20 m, process connection G cannot be selected |
| PROCESS CONNECTION | |
| G | pipe thread |
| F | flange |
| TYPE OF OUTPUT | |
| I | current output (4 ... 20 mA) |
| U | voltage output(0 ... 10 V) |
| M | RS-485 line with Modbus RTU communication, electrical connection G and C cannot be selected and set-up elements T and M cannot be selected |
| P | PNP switching transistor with an open collector |
| S | two-state current switch 4 mA / 20 mA |
| ELECTRICAL CONNECTION | |
| G | connector ISO |
| C | connector M12 |
| B | standard cable gland |
| H | cable gland for protective hose |
| SET-UP ELEMENTS | |
| T | setting using buttons |
| M | setting using a magnetic pen (MP8) |
| L | no setting controls and LED (only for ULM-53) |
| ADJUSTABLE RANGE | |
| 0002 ... 0010 | adjustable range (in dm): – only variants without setting controls „L“ with output type „I“ and „U“ |
| 0004 ... 0020 | adjustable range (in dm): – only variants without setting controls „L“ with output type „I“ and „U“ |
| 0006 ... 0060 | adjustable range (in dm): – only variants without setting controls „L“ with output type „I“ and „U“ |
| 0010 ... 0100 | adjustable range (in dm): – only variants without setting controls „L“ with output type „I“ and „U“ |
| 0020 ... 0200 | adjustable range (in dm): – only variants without setting controls „L“ with output type „I“ and „U“ |
| CABLE | |
| K | cable length in m, only for variants with connection type "B" and "H" |
| ULM-53 | N - 20 - F - U - H - M |
| K 5 | EXAMPLE OF CODING |

13. CORRECT SPECIFICATION EXAMPLES

ULM-53N-02-G-I-G-T

(N) Performance for non-explosive areas; (02) maximum range 0,2 ... 2 m; (G) process connection pipe thread; (I) current output (4 ... 20 mA); (G) connection method ISO connector; (T) set-up elements by buttons.

ULM-53N-20-F-U-H-M K 5

(N) Performance for non-explosive areas; (20) maximum range 0,5 ... 20 m; (F) process connection flange; (U) voltage output (0 ... 10 V); (H) connection method cable gland for protective hose; (M) set-up elements by magnetic pen (MP8).

ULM-53Xi-06-G-I-B-M K 5

(Xi) Performance for explosive areas; (06) maximum range 0,2 ... 6 m; (G) process connection pipe thread; (I) current output (4 ... 20 mA); (B) connection method standard cable gland; (M) set-up elements by magnetic pen (MP8).

ULS-53N-02-G-P-G-T

(N) Performance for non-explosive areas; (02) maximum range 0,2 ... 2 m; (G) process connection pipe thread; (P) PNP switching transistor with an open collector; (G) connection method ISO connector; (T) set-up elements by buttons.

ULS-53N-20-F-P-H-M K 5

(N) Performance for non-explosive areas; (20) maximum range 0,5 ... 20 m; (F) process connection flange; (P) PNP switching transistor with an open collector; (H) connection method cable gland for protective hose; (M) set-up elements by magnetic pen (MP8).

ULS-53Xi-06-G-S-B-T K 5

(Xi) Performance for explosive areas; (06) maximum range 0,2 ... 6 m; (G) process connection pipe thread; (S) two-state current switch 4 mA / 20 mA; (B) connection method standard cable gland; (T) set-up elements by buttons.

14. ACCESSORIES

standard (included in the level meter price)

- 1x seal (for UL_-53_- 01; 02; 06, 10)
- 1x connector with IP67 coverage (for versions with an ISO connector)
- 1x magnetic pen MP-8 (for device type adjusted by a magnetic pen)
- free-to-download programme Basic Scada Level (for the Modbus version)

optional – for a surcharge (see catalogue sheet of accessories)

- plastic fixing nuts PUM-G³/₄, PUM-G1, PUM-G1¹/₂ a PUM-G2¹/₄
- horn adapter ST-G0,75 , ST-G1 (thread G1"), ST-G1,5 and ST-G2,25
- plastic fixing flange PR-G2¹/₄ dle EN 1092-1, PN6, DN65 (for version with maximal range under 10 m)
- Weld flanges – stainless steel or plastic NN-G³/₄, ON-G³/₄, NN-G1, ON-G1, NN-G1¹/₂ a ON-G1¹/₂
- socket ELWIK 4012 K PG7
- connector with IP67 coverage (type GAN-DADE 7A) with 5m cable (for current output and ISO type connector)
- connector with IP67 coverage (type GAN-DAEE 7A) with 5m cable (for voltage output and ISO type connector)
- protective hose (for "H" version)
- converter URC-485 (for the Modbus version)

15. SAFETY, PROTECTION, COMPATIBILITY AND EXPLOSION PROOF

The ULM-53 level meter and the ULS-53 sensor are equipped with protection against reverse polarity of the supply voltage and against short voltage surges and with protection against current overload at the output.

Protection against dangerous contact is provided by low safety voltage according to EN 332000-4-41. Electromagnetic compatibility is provided by conformity with standards EN 55011/B, EN 61326-1 and EN 61000-4-2 to 6.

Explosion proof ULM-53Xi and ULS-53Xi is provided by conformity with standards EN 60079-0:2007; EN 60079-11:2007 and EN 60079-26:2007.

Explosion proof ULM-53Xi and ULS-53Xi is verified FTZÚ – AO 210 Ostrava – Radvanice: FTZÚ 09 ATEX 0119X.

A declaration of conformity has been issued for this device in accordance with Act No 90/2016 Coll., as amended. The supplied electrical device conforms to the applicable government regulations concerning safety and electromagnetic compatibility.

Special conditions for the safe use of variants ULM-53Xi a ULS-53Xi

The device is designed for connection to isolating repeater IRU-420. When another approved supply unit whose output parameters meet the above-mentioned output parameters is used, it is necessary to provide galvanic separation or, if a supply unit without galvanic separation (Zener barriers) is used, it is necessary provide potential equalization between the sensor and the grounding point of the barrier.

For application in zone 0, the present explosive atmosphere, comprising a mixture of air with gases, vapour or mists, shall comply with: $0.8 \text{ bar} \leq p \leq 1.1 \text{ bar}$.

It is necessary to ground the flange in variants ULM-53Xi-20-F-I and ULS-53Xi-20-F-I using a ground terminal located on the flange.



The device shall be installed in a way to prevent mechanical damage to the sensor face.

16. USE, MANIPULATION AND MAINTENANCE

The ULM-53 level meter and the ULS-53 sensor do not require any maintenance for operation. During operation, the operators of the technology are informed of the level height of the measured material through a connected display unit.

Maintenance of the device consists in verification of integrity of the device and the supply cable. Depending on the nature of the material measured, we recommend to verify the cleanliness of the emitting flat area of the ultrasound transducer at least once per year and to clean it, if required. In case any visible defects are discovered, the manufacturer or reseller of this equipment shall be contacted immediately.



It is forbidden to perform any modifications or interventions into the ULM-53 level meter and the ULS-53 sensor without the manufacturer's approval. Repairs, if any, shall only be done at the manufacturer or authorized service organization.



Assembly, installation, commissioning, operation and maintenance of the ULM-53 level meter and the ULS-53 sensor shall be carried out in accordance with this User's Guide; the provisions of standards in force regarding the installation of electrical equipment shall be adhered to. Assembly, installation, commissioning, operation and maintenance in explosive atmospheres shall be carried out in compliance with EN 60079-14 (Electrical installations for explosive gaseous atmospheres – Part 14: Electrical installations in dangerous areas other than mining) and possibly also in compliance with other standards relating to the area concerned.

17. GENERAL CONDITIONS AND WARRANTY

Dinel, s.r.o. guarantees for the period of three (3) years that the product has the characteristics as mentioned in the technical specification.

Dinel, s.r.o. is liable for defects ascertained within the warranty period and were claimed in writing.

This guarantee does not cover the damages resulting from misuse, improper installation or incorrect maintenance.

This guarantee ceases when the user or the other person makes any changes on the product or the product is mechanically or chemically damaged, or the serial number is not readable.

The warranty certificate must be presented to exercise a claim.

In the case of a rightful complaint, we will replace the product or its defective part. In both cases, the warranty period is extended by the period of repair.

18. MARKING OF LABELS

Labels for device of the type **ULM-53** _ _ _ _ _ :

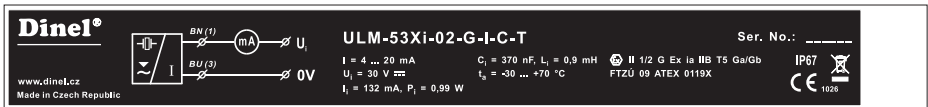

Symbol of producer: logo Dinel®

Internet address: www.dinel.cz

Country of origin: Made in Czech Republic

Connection scheme and labelling of wires: U, 0V (for ULM-53N current output)
 U_i, 0V (for ULM-53Xi)
 +U, U_{out}, 0V (for ULM-53N voltage output)
 +U, 0V, A, B (for ULM-53N for Modbus)

Type of level meter: ULM-53 _ _ _ _ _

Product serial number: Ser. No.: xxxxx - (from left: year of manufacture, serial production No.)

Output current range: I = 4 ... 20 mA or output voltage range: U_{out} = 0 ... 10V

Supply voltage range: U = 18 ... 36 mA (applies to version ULM-53N)

Limit parameters: U_i = 30 V, I_i = 132 mA, P_i = 0,99 W, C_i = 370 nF, L_i = 0,9 mH
 (applies to version ULM-53Xi)

Ambient temperature range: t_a = -30 ... +__ °C (Temperature range according to the type)

Mark of non-explosive device: (applies to version ULM-53Xi)

Variant: II _ G Ex ia II _ T5 _/_ , see Classification of non-explosive design
 (applies to version ULM-53Xi)

Number of certificate of intrinsic safety: FTZÚ 09 ATEX 0119X (applies to version ULM-53Xi)
 Protection class: IP67 or IP68; Compliance mark: **CE**
 Number of authorized person supervising over the quality system: 1026
 (applies to version ULM-53Xi)
 Electro-waste take-back system mark: 

Labels for device of the type **ULS-53N-_-_-_-_-_-_-_-**:

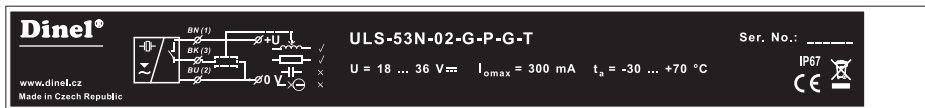

Symbol of producer: logo Dinel®

Internet address: www.dinel.cz

Country of origin: Made in Czech Republic

Connection scheme and labelling of wires: +U, 0V (for version ULS-53N)
 +Ui, 0V (for version ULS-53Xi)

Type of level meter: ULS-53 -_-_-_-_-_-_-_-

Product serial number: Ser. No.: xxxxx - (from left: year of manufacture, serial production No.)

Output current range: I=4 ... 20mA

Supply voltage range: U=18 ... 36mA (applies to version ULS-53N)

Maximum switch current: Iomax=300 mA

Limit parameters: Ui=30V=, Ii=132mA; Pi=0,99W; Ci=370nF; Li=0,9mH
 (applies to version ULS-53Xi)

Ambient temperature range: ta= -30 ... +__°C (Temperature range according to the type)

Mark of non-explosive device:  (applies to version ULS-53Xi)

Variant: II _ G Ex ia II _ T5 _/_ , see Classification of non-explosive design
 (applies to version ULS-53Xi)

Number of certificate of intrinsic safety: FTZÚ 09 ATEX 0119X (applies to version ULS-53Xi)

Protection class: IP67 or IP68; Compliance mark: **CE**

Number of authorized person supervising over the quality system: 1026
 (applies to version ULS-53Xi)

Electro-waste take-back system mark: 



Size of labels 175 x 20 mm, the size shown does not correspond to reality.

19. TECHNICAL SPECIFICATIONS

| BASIC TECHNICAL DATA | | |
|--|--|---|
| Measurement range ¹⁾ | UL_53_01_-- UL_53_02_-- UL_53_06_-- UL_53_10_-- UL_53_20_-- | 0,10 ... 1 m 0,20 ... 2 m 0,20 ... 6 m 0,4 ... 10 m 0,5 ... 20 m |
| Current consumption | ULM-53N(Xi)---_--I ULM-53N---_--U ULM-53N---_--M ULS-53N---_--P ULS-53N(Xi)---_--S | 4 ... 20 mA / max. 22 mA max. 12 mA max. 20 mA max. 12 mA disconnected 4 mA / connected 20 mA |
| Power supply voltage | ULM-53N and ULS-53N ULM-53Xi and ULS-53Xi | 12 ... 36 V DC 12 ... 30 V DC |
| Output | ULM-53---_--I ULM-53N---_--U ULM-53N---_--M ULS-53N---_--P ULS-53---_--S | 4 ... 20 mA (limit values 3.9 ... 20.5 mA) 0 ... 10 V (limit values 0 ... 10,2 V) RS-485 line with Modbus RTU PNP transistor with an open collector (max. switch current 300 mA) two-state current switch 4 mA / 20 mA |
| Resolution | | < 1 mm |
| Measurement accuracy (of the total range) | UL_53_01_ in the area 0,1 -0,2 m / 0,2 -1,0 m UL_53_02_ ; -06 UL_53_10_ ; -20 | 0,3 % / 0,2 % 0,15 % 0,2 % |
| Temperature error | | max. 0,04% / K |
| Beam width (-3 dB) | UL_53_01_-- ; 02_-- ; 10_-- UL_53_06_-- UL_53_20_-- | 10° 14° 12° |
| Max. ambient temperature range | UL_53_01_-- ; 02_-- ; 06_-- UL_53_10_-- ; 20_-- | -30 ... +70°C -30 ... +60°C |
| Short time temperature stress resistance | | +90°C / 1 hod. |
| Measuring period | UL_53_01_-- ; 02_-- UL_53_06_-- ; 10_-- UL_53_20_-- UL_53_---_--M | 0,5 s 1,2 s 5,0 s adjustable through Modbus RTU |
| Averaging | UL_53_---_-- ULM-53_---_--M | 4 measurements ³⁾ adjustable through Modbus RTU |
| Maximum operating overpressure (on transmission surface) | | 0,1 MPa |
| Limit operating parameters ²⁾ (for the Xi version only) | | U _i =30V DC; I _i =132mA; P _i =0,99W; C _i =370nF; L _i =0,9mH |
| Failure indication | echo failure – default mode echo failure – inverse mode level in dead zone ⁴⁾ – default mode level in dead zone ⁴⁾ – inverse mode | 3,75 mA / 0 V / Modbus RTU 22 mA / 10,5 V / Modbus RTU 22 mA / 10,5 V / Modbus RTU 3,75 mA / 0 V / Modbus RTU |

¹⁾ Applicability for measuring the surface level of loose materials is limited, the range of measurement is shorter there.

²⁾ Permitted range of pressures in the area of zone 0 (design Xi): 80 ... 110kPa.

³⁾ From the last six measurements are taken out extreme values MAX and MIN, then the remaining four measurement was performed arithmetic average

⁴⁾ Dead zone = blind zone = blocking zone.

BASIC TECHNICAL DATA

| | | |
|--|--|--|
| Protection class | UL_53_ _ _ _ _ T UL_53_ _ _ _ _ G-M, L | IP67 |
| | UL_53_ _ _ _ _ C-M, L | IP67 ⁵⁾ |
| | UL_53_ _ _ _ _ B-M, L UL_53_ _ _ _ _ H-M, L | IP68 |
| Tightening torque for cable gland | | 3 Nm |
| Recommended cable | ULM-53_ _ _ _ _ I ; ULS-53_ _ _ _ _ S ULM-53N_ _ _ _ _ U ; ULS-53N_ _ _ _ _ P ULM-53N_ _ _ _ _ M | PVC 2 x 0.75 mm ² PVC 3 x 0.50 mm ² PVC 2x2 0,25 mm ² |
| Maximum load resistance of current output at | U = 24 V DC U = 22 V DC U = 20 V DC | R _{max} = 270 Ω R _{max} = 180 Ω R _{max} = 90 Ω |
| Minimum load resistance of voltage output | | R _{min} > 1 kΩ |
| Delay between supply power rise time and first measurement | UL_53_ _01_ _ ; 02_ _ ; 06_ _ UL_53_ _10_ _ ; 20_ _ | 5 s 9 s |
| Process connection | UL_53_ _01_ _ UL_53_ _02_ _ UL_53_ _06_ _ UL_53_ _10_ _ UL_53_ _20_ _ | fitting with thread G 3/4" fitting with thread G 1" fitting with thread G 1 1/2 " fitting with thread G 2 1/4 " flange of Al alloy |
| Weight | UL_53_ _01_ _ UL_53_ _02_ _ UL_53_ _06_ _ UL_53_ _10_ _ UL_53_ _20_ _ | cca 0,20 kg cca 0,20 kg cca 0,25 kg cca 0,65 kg cca 2,80 kg |

⁵⁾ Protection class IP68 can be achieved when a special connector is used.

MATERIALS

| sensor part | type variant | standard material |
|-----------------------------|--------------|--------------------------|
| Housing | all | plastic PP |
| Electro-acoustic transducer | all | plastic PVDF |
| Flange | UL_53_ _20 | lacquered aluminum alloy |
| Cable gland | all | plastic PA |

FACTORY DEFAULT TABLE*

| | ULM-53_ _01 | ULM-53_ _02 | ULM-53_ _06 | ULM-53_ _10 | ULM-53_ _20 |
|---------------------------|-------------|-------------|-------------|-------------|-------------|
| Minimum range (20 mA) | 0,10 m | 0,20 m | 0,20 m | 0,4 m | 0,5 m |
| Maximum range (4 mA) | 1 m | 2 m | 6 m | 10 m | 20 m |
| | ULS-53_ _01 | ULS-53_ _02 | ULS-53_ _06 | ULS-53_ _10 | ULS-53_ _20 |
| Connection level (ON) | 0,45 m | 0,90 m | 2,7 m | 4,5 m | 9 m |
| Disconnection level (OFF) | 0,65 m | 1,30 m | 3,9 m | 6,5 m | 13 m |

*) Upon agreement, individual settings can also be made.

WORKING AREAS AND AREA CLASSIFICATION (under EN 60079-10 and EN 60079-14)

| | |
|--|---|
| UL_–53N–__–_ | Basic performance for non-explosive areas. |
| ULM–53Xi–01(02, 06)–_–I ULS–53Xi–01(02, 06)–_–S | Intrinsically safe explosion-proof performance for use in hazardous areas (explosive gas atmospheres) Ⓜ II 1/2G Ex ia IIB T5 Ga/Gb with intrinsically safe supply units ¹⁾ , whole level meter (sensor) zone 1, front head part 0. |
| ULM–53Xi–10–_–I ULS–53Xi–10–_–S | Intrinsically safe explosion-proof performance for use in hazardous areas (explosive gas atmospheres) Ⓜ II 2G Ex ia IIA T5 Ga/Gb with intrinsically safe supply units ¹⁾ , whole level meter (sensor) zone 1, front head part 0. |
| ULM–53Xi–20–_–I ULS–53Xi–20–_–S | Intrinsically safe explosion-proof performance for use in hazardous areas (explosive gas atmospheres) Ⓜ II 2G Ex ia IIA T5 Gb with intrinsically safe supply units ¹⁾ , whole level meter (sensor) zone 1. |

¹⁾ Intrinsically safe isolating repeater (e.g. Dinel IRU–420).

19. PACKING, SHIPPING AND STORAGE

The ULM–53 or ULS–53 device is packed in a cardboard packaging and the whole shipment is placed in a cardboard box. The cardboard box is suitably filled to prevent mechanical damage during transport.

Remove the device from the package just prior to its use to prevent possible damage.

Transport to the customer is provided by a forwarding company. Subject to prior arrangement, personal pick-up of the ordered goods is possible in the company's seat. Upon receipt, please check whether the shipment is complete and corresponds to the extent of the order, or whether during the transport the packaging and the device has not been damaged. Do not use a device apparently damaged during transport and contact the manufacturer to resolve the situation.

If the device is transported further, it shall be wrapped in the original packaging and protected against shocks and weather.

Store the device in its original packaging in a dry place, sheltered from weather, with humidity up to 85% without the effects of chemically active substances. The range of storage temperature is -20°C to +60°C.



Level meters (sensors) of variants ULM (ULS)–53 –01, 02, 06, 10 are fitted with protective caps to prevent damage to the ultrasonic transducer. Remove the caps before commissioning!

ООО “РусАвтоматизация”

454010 г. Челябинск, ул. Гагарина 5, оф. 507

тел. 8-800-775-09-57 (звонок бесплатный), +7(351)799-54-26, тел./факс +7(351)211-64-57

info@rusautomation.ru; rusавтоматизация.рф; www.rusautomation.ru