

Dissolved Oxygen Online Analyzer

Operation Manual







Introduction

- Thank you for purchasing the Dissolved Oxygen online analyzer. The operation manual gives a detailed description about various realizable functions, wiring methods, setup methods, operation methods and fault handling methods. Please read carefully the operation manual and understand the correct application methods before putting into operation, to avoid unnecessary losses due to operation mistakes. If the instrument is operated in other ways not described in the manual, the protections that the instrument give may be destroyed, and the failures and accidents incurred due to violation of precautions shall not be borne by our company.
- Please read the operation manual carefully before applying the instrument. On the precondition of full understanding, the instrument shall be installed, operated and maintained by professional electrical personnel at site. Wrong installation or operation may lead to destruction of instrument or personal injury.
- The company promises to the user that, the hardware and accessories provided with the instrument during delivery shall not have any defects in materials and manufacturing process. Calculated from the day of purchase of the instrument, if the user informs of any defect on the product in the guaranty period, the company provides free maintenance or replacement unconditionally for the defect product. The company guarantees to provide lifelong maintenance for all the products.
- Following the principle of sustainable development, the company shall reserve the rights of modifying the performance parameters in the operation manual and also the rights of amending or abolishing the operation manual, without prior notification. The company shall notify the user in advance if modification of some parameters of the instrument may lead to serious accident. For improved instrument, the company shall publish updated operation manual or improvement instruction. If the descriptions in the operation manual deviate from the material object, the latter shall prevail.

- Any modification on the instrument is forbidden. Any accidents incurred due to unauthorized modification shall not be borne by the company.

Indication of Signs in the Operation Manual

Sign	Name	Meaning
	DANGER	Serious personal injury, instrument destruction, great property losses or other accidents will be the consequence if no appropriate preventive measures have been adopted.
	ALERT	Pay special attention to the important information linked to product or particular part in the operation manual.
	WARNING	Operate with cautious. Any operation mistake may lead to big problems.
	ATTENTION	Read carefully the annotation, which will provide substantial help to correct operation of the instrument.



DANGER

- Do not use the instrument in a flammable and combustible or steam area.
- The instrument can work in general cases. If the failure of the instrument may result in major accident or destroy other equipment, emergency stop electric circuit and protection loop should be set up.
- Confirm if the supply voltage is in consistent with the rated voltage before operation.
- To prevent from electric shock, operation mistake, abnormal display or big deviation in measurement, a good grounding protection must be made.
- Thunder prevention engineering facilities must be well managed: the shared grounding network shall be grounded at iso-electric level, shielded, wires shall be located rationally, SPD surge protector shall be applied properly.
- Some inner parts may carry high voltage. Do not open the square panel in the front except our company personnel or maintenance personnel acknowledged by our company, to avoid electric shock.
- Cut off electric powers before making any checks, to avoid electric shock.

- Check terminal screws and installation conditions on a regular basis. If it's loose, tighten it and then apply it.
- Unauthorized dismantling, processing, modification or repair of instrument can never be allowed. Otherwise, the instrument may move abnormally, or electric shock or fire accidents may be caused.
- Use dry cotton to wipe the instrument, instead of alcohol, gasoline or other organic solvent. Prevent any liquid from splashing onto the instrument. If the instrument falls into water, cut off power immediately, to avoid electric leakage, electric shock and fire accidents.
- Check grounding protection and fuse conditions on a regular basis. Do not run the equipment if grounding protection and fuse are not well equipped.
- The ventilation hole on the instrument casing must be kept unclogged, to avoid failure, abnormal movement, short lifetime and fire accident due to high temperature.
- Operate in strict accordance with the operation manual, otherwise, it's possible to damage the protection device of the instrument.



ALERT

- Do not use the instrument if it is found damaged or deformed at opening of package.
- Prevent dust, wire end, iron fines or other objects from entering the instrument during installation, otherwise, it will cause abnormal movement or failure.
- During operation, to modify configuration, signal output, startup, stop, operation safety shall be fully considered. Operation mistakes may lead to failure and even destruction of the instrument and controlled equipment.
- Each part of the instrument has a certain lifetime, which must be maintained and repaired on a regular basis for long-time use.
- The product shall be scrapped as industrial wastes, to prevent environment pollution.

User instruction

Please respect the operation procedures and precautions in the operation manual to use the product.

The instrument can work in general cases. If the failure of the instrument may result in major accident or destroy other equipment, emergency stop electric circuit and protection loop should be set up.

- The quality guaranty period of electrode of conductivity is one year, for the sake of more accurate measurement. After one year upon ex-work, the performance

will be influenced whether to be further used. Then it should be replaced in time.

- Power on the instrument before calibration to preheat for over half an hour.
- During measurement, clean the instrument in distilled water (or deionized water) and dry with filter paper, to avoid inclusions in the test liquid.
- Contact the manufacturer in case of anomaly or damage of the instrument. Do not repair it at your own.

Contents

Introduction.....	1
User Instruction.....	3
Section I Product Introduction.....	6
Characteristics.....	6
Technical Indicators.....	7
Application Scope.....	8
Section II Fixation & Installation.....	9
Installation of Instrument.....	9
Installation of Electrode.....	10
Wiring of Instrument.....	11
Section III Push-button Operation.....	13
Section IV HMI and Operation.....	14
Section V Configuration.....	17
System Configuration.....	17
Signal Configuration.....	17
Online Calibration.....	18
Remote Transmission Configuration.....	18
Alarm Configuration.....	19
Version Inquiry.....	20
Section VI Communication.....	21
Section VII Failure Analysis & Trouble-shooting.....	23
Appendix.....	24

Section I Production Introduction

Dissolved oxygen online analyzer, an intelligent online chemical analyzer, is widely applied for continuous monitoring and measurement of dissolved oxygen, saturation, oxygen partial pressure and temperature in the solution in the industry of thermal power, chemical fertilizer, environmental protection, metallurgy, pharmacy, biochemistry, food and water, etc.

Continuous monitoring measurement data is connected with the recorder via transmitting output to realize remote monitoring and recording. It can also be connected with RS485 portal via MODBUS-RTU protocol to access computer for monitoring and recording.

Characteristics

- 2.8 inches 12864 lattice screen.
- Isolating transmitting output, with little interference.
- Isolating RS485 communication.
- DO/SAT/OPP measurement, temperature measurement, upper/lower limit control, transmitting output, RS485 communication.
- Configurable manual and auto temperature offset function.
- Configurable upper/lower limit alarm and delay.
- Configurable hummer and LCD backlight switch.
- Optional language, Chinese and English.
- Zero oxygen and full-scale calibration.

Technical indicators

- Measurement variables: dissolved oxygen, saturation, oxygen partial pressure.
Measuring range: 0 - 20mg/L, 0 - 200%, 0 - 400hPa
Resolution: 0.01mg/L, 0.1%, 1hPa
Accuracy: $\pm 1.5\%$ FS
Repetition: $\pm 0.5\%$ FS
- Temperature measurement type: NTC 10K/PT1000, auto A/manual H
Measuring range: -10 - 60°C
Resolution: 0.1°C
Correction accuracy: $\pm 0.5^\circ\text{C}$
- Output type: 4 - 20mA current transmission output
Max. loop resistance: 750Ω
Accuracy: 0.1%FS
- Output type: RS485 digital signal output
Communication protocol: standard MODBUS-RTU (customizable)
- Power: AC220V $\pm 10\%$, 50Hz/60Hz (optional 24V $\pm 10\%$)
- Alarm relay: AC250V、3A

Application Scope

- Sewage treatment plant
- Waste water treatment
- Water treatment
- Drinking water
- Surface water: river, lake, sea
- Fishery
- Boiler feed water (trace oxygen measurement)

Section II Fixation & Installation

Installation of instrument

Please read the instruction of installation location and method of instrument as described during installation.

Installation precautions

The instrument serves mainly for detection and transmission, not dedicated for control. It is equipped with a relay switch output, for warning and reminding use generally. If the user involves the function in participating loop control, the failure of the instrument may lead to major accident or destruction of other equipment, emergency stop electric circuit and protection loop should be set up. Otherwise, the company will not be liable for any consequences incurred.

The instrument is panel-mounted and should be installed indoor, sheltered from wind, rain and direct sunlight. To avoid rise of temperature inside the instrument, it should be installed at a well-ventilated place. Do not tilt it during installation and try to locate it horizontally (tilting back 30°).

Installation should be kept away from the following site

In direct exposure to sunlight and near thermal equipment.

With ambient temperature over 60 degrees in operation.

With humidity over 85% in operation.

Nearby electromagnetic source.

In strong mechanical vibration.

With varying temperature and dew condensation.

With oil smoke, steam, humidity, dust and corrosive gases.

Installation methods

Open a 92.5 * 92.5 installation hole on the instrument cabinet or installation panel (the dimension is 100*100*150mm). Insert the instrument into the installation hole and latch on the butterfly clasp, as shown below.

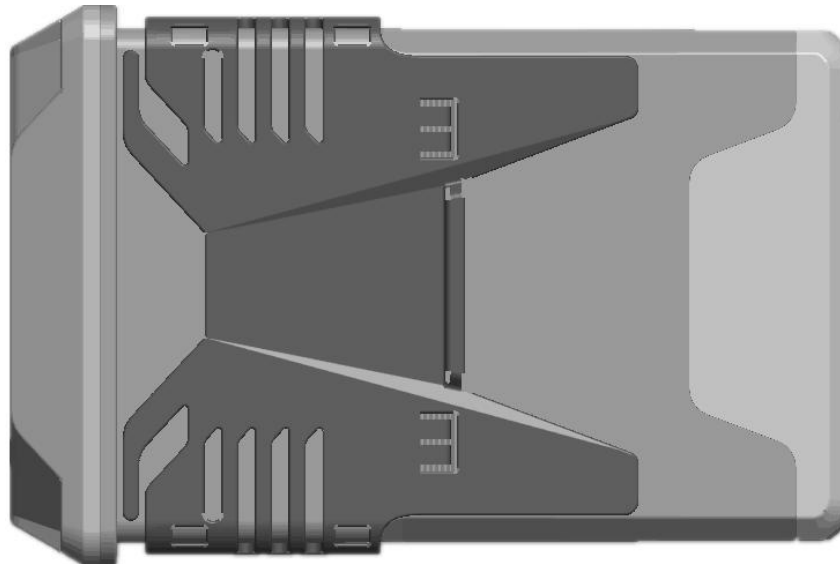

Installation of electrode

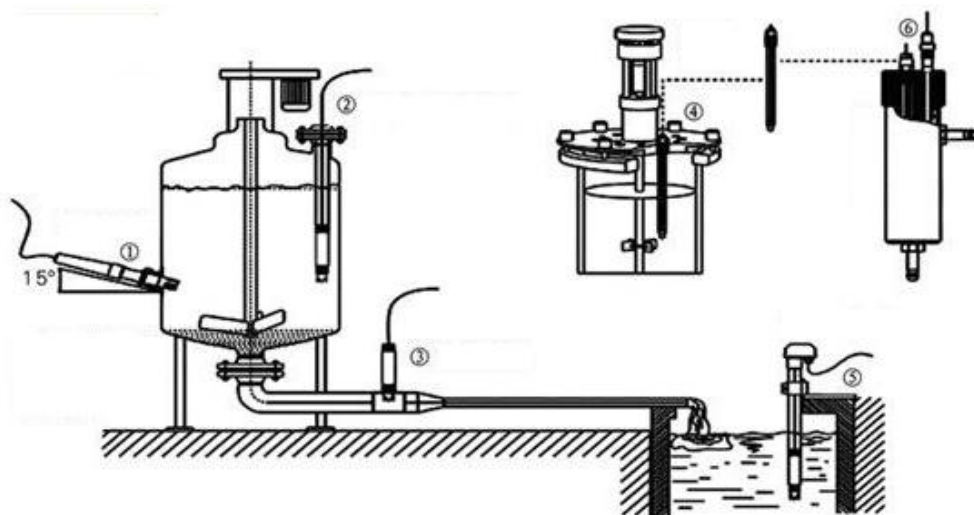

Schematic diagram of common installation method

1. Side wall installation.
2. Top flange type installation.
3. Pipe installation.
4. Top type installation.
5. Immersed type installation.
6. Flow-through type installation.

The connector must be an oblique angle at 15 degree, otherwise, the normal test and use will be impacted, and the consequences will not be borne by our company.

Wiring of instrument

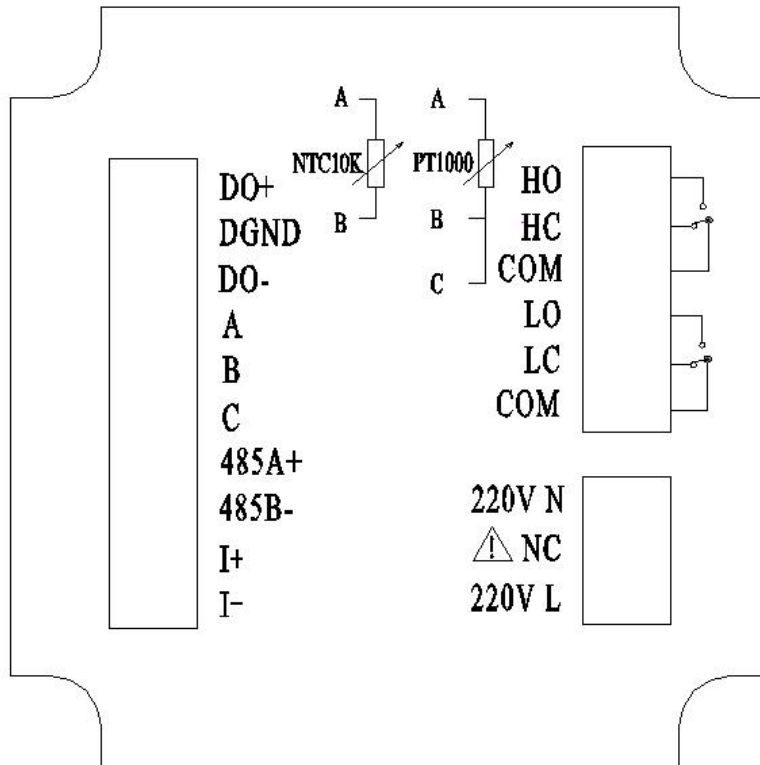

Wiring diagram

Identification of terminal

- DO+: Dissolved oxygen electrode anode
- DGND: Dissolved oxygen electrode shielded wire
- DO-: Dissolved oxygen electrode cathode
- TEMPA: temperature offset terminal A, NTC10K A and PT1000 A
- TEMPB: temperature offset terminal B, NTC10K B and PT1000 B
- TEMPC: temperature offset terminal C, temperature

of PT1000 three-wire system and PT1000 two-wire system need to be short-circuited with TEMPB, NTC10K does not need to connect with TEMPC.

- RS485(A+):RS485 communication interface A+
- RS485(B-):RS485 communication interface B-
- I(+):4-20mA output port +
- I(-):4-20mA output port -
- HO: high alarm of normal open relay
- HC: high alarm of normal close relay
- COM: common port
- LO: low alarm of normal open relay
- LC: low alarm of normal close relay
- COM: common port
- 220V L:AC220V fire wire
- NC: null
- 220V N:AC220V zero wire

Attention

Confirm that the instrument is not power on before connected with signal wire, to avoid electric shock.

Use double insulation wire to prevent fire accident.



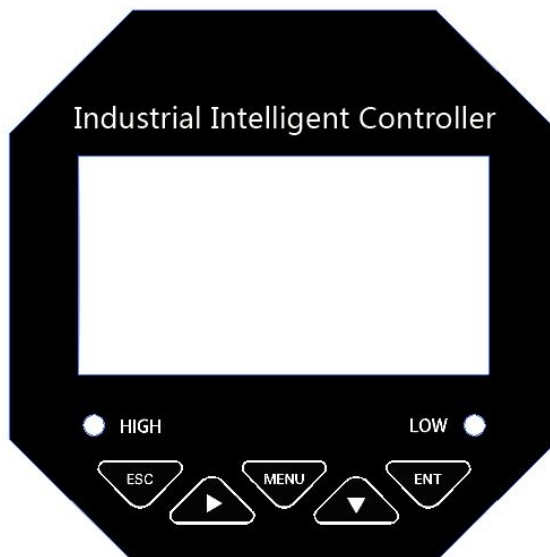

Do not put electric product close to signal terminal, which may cause failure.

Section III Push-button Operation

Button display



Definition of buttons

Sign	Button Name	Function description
	MENU	Enter the MENU on the “monitoring page” Exit the MENU on the “menu page”
	EXIT	Check the related alarm status on the “monitoring page” Return to previous level page in the up& down level page linked to “menu page”
	MOVE RIGHT	Make a recurrent selection of digit of parameters Check the display values of other unit on the “monitoring page”
	MOVE DOWN	Select the related menu on the “menu page” Modify the values in the configuration state
	ENTER	Enter the submenu or confirm modification on the “menu page”

Section IV HMI and Operation

Monitoring page

The instrument is equipped with monochrome lattice LCD, 128*64 resolution.

Push [MENU] to enter password verification page; input password to enter the home page.

Push [EXIT] to enter alarm inquiry page, to inquire the current alarm configuration information.

Push [MOVE RIGHT] to display switch of unit, which shows the value of dissolved oxygen, saturation, oxygen partial pressure and current. After 10s without other operation, it goes back to the selected unit value.

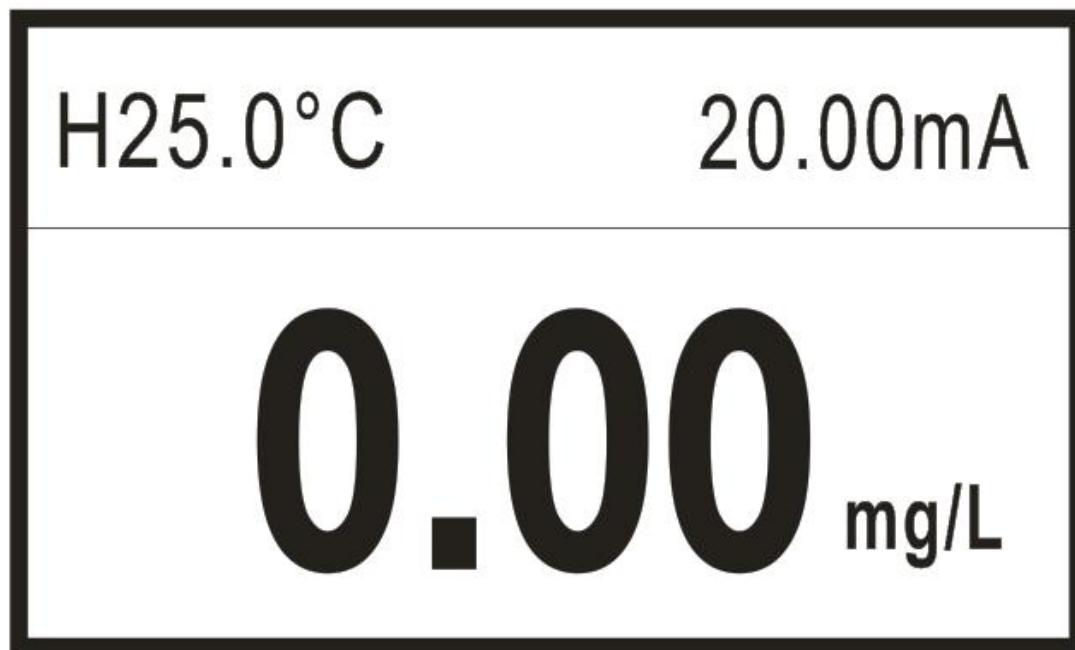

Dissolved oxygen monitoring page

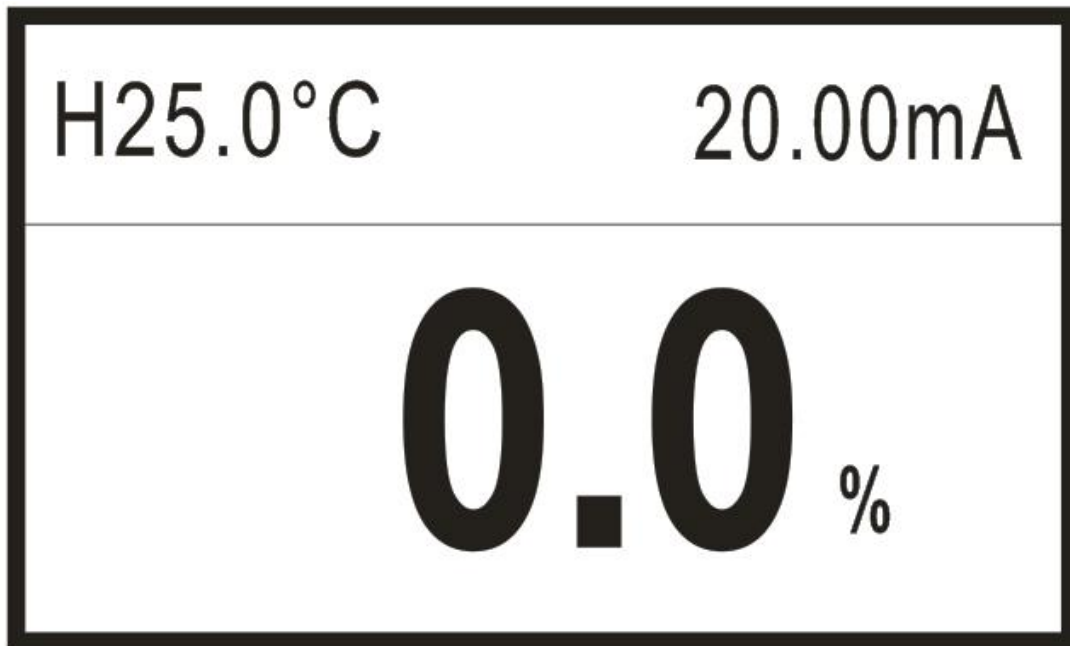

Saturation monitoring page

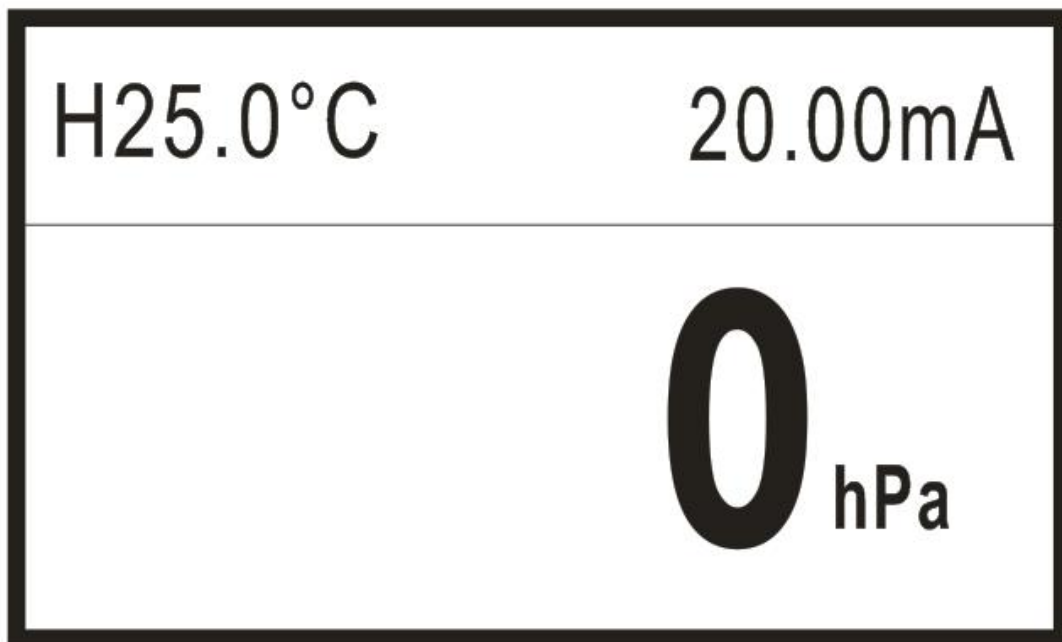

Oxygen partial pressure monitoring page

Password verification page

Input password and push [ENTER] to enter home page.

Initial password is 0000, which can be modified via password modification function.

Please contact us if you forget your password.

----- User Password -----

Password: 0000

Main menu

----- Main Menu -----

- ➡ 1. System Setting
- 2. Signal Setting
- 3. Online Calibration
- 4. Remote Setting
- 5. Alarm Setting
- 6. Version Query

System Setting: settings of language, buzzer and backlight, modification of password and factory settings

Signal Setting: switch of unit and temperature offset, and settings of salinity and air pressure offset.

Online Calibration: correction of temperature, calibration of zero point and full scale of dissolve oxygen signal.

Remote Setting: settings of RS485 parameters and current transmission output.

Alarm Setting: settings of parameters of high and low alarm.

Version Query: current version number

Section V Configuration

System configuration

— — — — System Setting — — — —

- ➡ 1. Language
- 2. Buzzer
- 3. Backlight Setting
- 4. Change Password
- 5. Factory Setting

Language: switch of language, Chinese and English.

Buzzer: setting of switch of buzzer during alarm.

Backlight Setting: setting of LCD backlight.

Change Password: password modification and log-in with new password.

Factory Setting: back to factory settings

Signal configuration

— — — — Signal Setting — — — —

- ➡ 1. Unit Switch
- 2. Salt Content Setting
- 3. Air Pressure Setting
- 4. Temp Switch

Unit Switch: switch among mg/L, % and hPa : mg/L for dissolved oxygen value ; % for saturation value ; hPa for oxygen partial pressure. Only by this function, the corresponding value of 4-20mA, high alarm and low alarm can be switched to the related measurement values.

Salt Content Setting: set the salinity of the current solution. The default is 0.00g/Kg.

Air Pressure Setting: set the air pressure value of the current altitude. The default value is the standard atmospheric pressure, 1013hPa, and the setting range is 500 - 1100 hPa.

Temp Switch: set the automatic temperature offset NTC 10K or PT1000 and manual temperature offset value, and the measuring range is -10 - 60°C.

Online calibration

- — — — Online Calibrtion — — — —
- ➡ 1.Temp Modification
 - 2.Zero Oxygen Calibration
 - 3. Full Scale Calibration

Temp Modification: correct the temperature value under automatic temperature offset, and the correction range is $\pm 20.0^{\circ}\text{C}$.

Zero Oxygen Calibration: under water-free sodium sulfite solution (configured with deionized water). (optional if not available, rare deviation on zero oxygen).

Full Scale Calibration: calibrate in the air or air-saturated water. Before calibration, make sure the electrode is polarized for over half an hour. After the number is stable, push [ENTER] to calibrate. (The liquid in the dissolved oxygen electrode solution by membrane method is consumed constantly. Therefore, before each measurement, the full scale need to be re-calibrated, and the liquid need to be refilled once every other month).

Remote Transmission Configuration

- — — — Remote Setting — — — —
- ➡ 1.RS485 Setting
 - 2.Current Transmission

RS485 Setting: set 485 communication address and baud rate.

Current Transmission: set 4mA corresponding value and 20mA corresponding value of 4-20mA output. (Only by unit switch function can the 4-20mA corresponding value be switched to the related measurement signal).

Alarm configuration

- Alarm Setting -----
- ➡ 1. DO High Alarm
 - 2. DO Low Alarm
 - 3. SAT High Alarm
 - 4. SAT Low Alarm
 - 5. OPP Low Alarm
 - 6. OPP Low Alarm

DO High Alarm: when the measured value is higher than high alarm pull-on value, high alarm relay pulls on; when the measured value is lower than high alarm cut-off value, high alarm relay cuts off. (Only by unit switch function can the high alarm and the low alarm be switched to the corresponding measured value).

DO Low Alarm: when the measured value is lower than low alarm pull-on value, low alarm relay pulls on; when the measured value is higher than lower alarm cut-off value, low alarm relay cuts off.

SAT High Alarm: when the measured value is higher than high alarm pull-on value, high alarm relay pulls on; when the measured value is lower than high alarm cut-off value, high alarm relay cuts off.

SAT Low Alarm: when the measured value is lower than low alarm pull-on value, low alarm relay pulls on; when the measured value is higher than lower alarm cut-off value, low alarm relay cuts off.

OPP High Alarm: when the measured value is higher than high alarm pull-on value,

high alarm relay pulls on; when the measured value is lower than high alarm cut-off value, high alarm relay cuts off.

OPP Low Alarm: when the measured value is lower than low alarm pull-on value, low alarm relay pulls on; when the measured value is higher than lower alarm cut-off value, low alarm relay cuts off.

Version inquiry

— — — — Version Query — — — —

Version Query: inquire the current hard software version, which is high traceable.

Section VI Communication

The instrument is provided with standard RS485 series communication interface, in accordance with international universal standard MODBUS-RTU communication protocol, supporting No.03 register reading and holding command.

MODBUS standard format (read and hold command from Register 03)

Command format:

Definition	Address	Function code	Register address	Data number	CRC check
Data	ADDR	0x03	M	N	CRC 16
Bytes	1	1	2	2	2

Return format:

Definition	Address	Function code	Register address	Data number	CRC check
Data	ADDR	0x03	2*N	Data	CRC 16
Bytes	1	1	1	2*N	2

Descriptions of register address:

Address	Data type	Data size	Function code	Description	Access authority
0x0000	short	2 bytes	0x03	DO value (unit:mg/L, to be divided by 100)	Read only
0x0001	short	2 bytes	0x03	Temperature value (unit: °C, to be divided by 10)	Read only
0x0002	short	2 bytes	0x03	Saturation value (unit: %, to be divided by 10)	Read only
0x0003	short	2 bytes	0x03	Oxygen partial pressure value(unit: hPa)	Read only

Example of DO reading:

Computer sends: 00 03 00 00 00 01 85 DB

DO meter returns: 00 03 02 00 00 85 84

Return command annotation:

00 is the address of slave device, which can be set in the instrument;
03 is the function code, reading and holding register;
02 is the length of data of returned DO value, 2 bytes;
02 is the returned PH value 686 (hexadecimal high byte);
00 00 is the returned DO value 0.00mg/L, to be divided by 100 to get the current DO value. Range: 0.00-20.00mg/L;
85 84 is the CRC16 check code, which changes along with the previous data;

Example of temperature reading:

Computer sends: 00 03 00 01 00 01 D4 1B

DO meter returns:00 03 02 00 FA 05 C7

Return command annotation:

00 is the address of slave device, which can be set in the instrument;
03 is the function code, reading and holding register;
02 is the length of data of returned temperature value, 2 bytes;
02 is the returned PH value 686 (hexadecimal high byte);
00 FA is the returned temperature value 25.0°C (unit: °C), to be divided by 10 to get the current DO value. Range: -10.0 - 60.0°C;
05 C7 is the CRC16 check code, which changes along with the previous data;

Section VII Failure Analysis & Trouble-shooting

1. No display on controller?

A: Check if the power cable is correctly connected, power is on.

2. Number in display is jumping up and down?

A: Check if there is any interference equipment such as frequency converter is nearby. The instrument should be kept away from such interference equipment or protected with good shielding measures.

3. The response of number is slow?

A: If the electrode is covered by dirt, the response would be slow. Clean the pollutant in a corresponding method. A slow response is normal in winter.

Appendix

The data source is HJ506—2009 national environment protection standard.

Temperature / °C	Solubility (mg/L) of oxygen under standard atmospheric pressure (101.325kPa)	Correction value [(mg/L)/(g/Kg)] of DO when the salt content in water is increased by 1g/Kg.	Temperature / °C	Solubility (mg/L) of oxygen under standard atmospheric pressure (101.325kPa)	Correction value [(mg/L)/(g/Kg)] of DO when the salt content in water is increased by 1g/Kg.
0	14.62	0.0875	21	8.91	0.0464
1	14.22	0.0843	22	8.74	0.0453
2	13.83	0.0818	23	8.58	0.0443
3	13.46	0.0789	24	8.42	0.0432
4	13.11	0.0760	25	8.26	0.0421
5	12.77	0.0739	26	8.11	0.0407
6	12.45	0.0714	27	7.97	0.0400
7	12.14	0.0693	28	7.83	0.0389
8	11.84	0.0671	29	7.69	0.0382
9	11.56	0.0650	30	7.56	0.0371
10	11.29	0.0632	31	7.43	0.0364
11	11.03	0.0614	32	7.30	0.0354
12	10.78	0.0593	33	7.18	0.0348
13	10.54	0.0582	34	7.07	0.0338
14	10.31	0.0561	35	6.95	0.0332
15	10.08	0.0545	36	6.84	0.0322
16	9.87	0.0532	37	6.73	0.0316
17	9.66	0.0514	38	6.63	0.0306
18	9.47	0.0500	39	6.53	0.0300
19	9.28	0.0489	40	6.43	0.0291
20	9.09	0.0475			

Table 1 The function among oxygen solubility, water temperature and water salt content

Dissolved Oxygen Online Analyzer – Operation Manual

Electric conductivity/ (mS/cm)	Salt content in water/ (g/Kg)	Electric conductivity/ (mS/cm)	Salt content in water/ (g/Kg)	Electric conductivity/ (mS/cm)	Salt content in water/ (g/Kg)
5	3	20	13	35	25
6	4	21	14	36	25
7	4	22	15	37	26
8	5	23	15	38	27
9	6	24	16	39	28
10	6	25	17	40	29
11	7	26	18	42	30
12	8	27	18	44	32
13	8	28	19	46	33
14	9	29	20	48	35
15	10	30	21	50	37
16	10	31	22	52	38
17	11	32	22	54	40
18	12	33	23		
19	13	34	24		

Table 2 The function between electric conductivity and salt content

Temperature/ °C	Pressure of saturated water steam/ hPa	Temperature/ °C	Pressure of saturated water steam/ hPa	Temperature/ °C	Pressure of saturated water steam/ hPa
0	6.1	15	17.1	30	50.2
1	6.6	16	18.1	31	53.2
2	7.1	17	19.3	32	56.2
3	7.6	18	20.7	33	59.4
4	8.1	19	22.0	34	62.8
5	8.7	20	28.1	35	66.2
6	9.3	21	29.9	36	69.8
7	10.0	22	31.7	37	73.4
8	10.7	23	33.6	38	77.2
9	11.5	24	35.6	39	81.0
10	12.3	25	37.7	40	85.0
11	13.1	26	40.0		
12	14.0	27	42.4		
13	14.9	28	44.9		
14	16.0	29	47.6		

Table 3 The function between pressure of saturated water steam and temperature

Altitude h / m	Average atmospheric pressure p/ hPa	Altitude h / m	Average atmospheric pressure p/ hPa	Altitude h / m	Average atmospheric pressure p/ hPa
0	1013	1900	799	3800	630
100	1001	2000	789	3900	622
200	988	2100	779	4000	614
300	976	2200	769	4100	607
400	964	2300	760	4200	599
500	952	2400	750	4300	592
600	940	2500	741	4400	584
700	928	2600	732	4500	577
800	917	2700	723	4600	570
900	905	2800	714	4700	563
1000	894	2900	705	4800	556
1100	883	3000	696	4900	549
1200	872	3100	687	5000	542
1300	861	3200	679	5100	535
1400	850	3300	670	5200	529
1500	840	3400	662	5300	522
1600	829	3500	654	5400	516
1700	819	3600	646	5500	509
1800	809	3700	638		

Table 4 The corresponding value of average atmospheric pressure and altitude