



RusAutomation

User Manual SONO-ES with SILO-HT Probe Head

SONO-ES with external SILO-HT Probe Head



ООО "РусАвтоматизация"

454010 г. Челябинск, ул. Гагарина 5, оф. 507
тел. 8-800-775-09-57 (звонок бесплатный), +7(351)799-54-26, тел./факс +7(351)211-64-57
info@rusautomation.ru; [русавтоматизация.рф](http://rusавтоматизация.рф); www.rusautomation.ru

User Manual for SONO-ES SILO

Thank you for buying an IMKO moisture probe.

Please carefully read these instructions in order to achieve best possible results with your SONO-ES in-line moisture measurement system. Should you have any questions or suggestions regarding your new system after reading, please do not hesitate to contact our authorised dealers or IMKO directly. We will gladly help you.

List of Content:

1. Instrument Description SONO-ES.....	4
1.1.1. The patented TRIME® TDR-Measuring Method.....	4
1.1.2. TRIME® compared to other Measuring Methods	4
1.1.3. Areas of Application with SONO-ES SILO	4
1.2. Mode of Operation	5
1.2.1. Measurement value collection with pre-check, average value and filtering.....	5
1.2.2. Determination of the mineral concentration with EC-TRIME	5
1.2.3. Material Temperature Measurement.....	5
1.2.4. Temperature compensation of the internal SONO-electronic	6
1.2.5. Analogue Outputs.....	6
1.3. The serial RS485 and IMP-Bus interface	7
1.3.1. The IMP-Bus as a user friendly network system.....	7
1.3.2. Error Reports and Error Messages	7
2. Configuration of the Measure Mode	8
2.1. Cyclic operation modes CA, CF, CH, CC and CK.....	8
2.1.1. <i>Average Time</i> in the measurement mode CA and CF	10
2.1.2. Filtering at material gaps in mode CA and CF	10
2.1.3. Mode CC – automatic summation of a moisture quantity during one batch process.	11
2.1.4. Mode CH – Automatic Moisture Measurement in one Batch	12
2.2. Overview of single modes for different applications	13
2.3. Calibration Curves	14
2.3.1. SONO-ES for measuring Moisture of Sand and Aggregates	17
2.4. Creating a linear Calibration Curve for a specific Material	18
2.4.1. Calculation for a linear 2-point calibration curve	18
2.4.2. Calculation for a linear 1-point calibration curve	19
2.4.3. Calculation for a non-linear calibration curve	19
2.5. Connectivity to SONO Probes	20
2.6. Connection Plug and Plug Pinning.....	21
2.6.1. Analogue Output 0..10V with a Shunt-Resistor.....	22
2.7. Connection diagram with SONO-VIEW	22

3. Installation of the Probe	23
3.1. Assembly Instructions	23
3.2. Assembly Dimensions	24
3.3. Mounting of SILO-ES Probe Head	25
3.4. Mounting on a silo or weighing bin	26
3.5. Gas- and waterproofed Installation in a Tube or Container	26
4. Serial Connection to the SM-USB Module from IMKO	27
5. Quick Guide for the Commissioning Software SONO-CONFIG	29
5.1.1. Scan of connected SONO probes on the serial interface	29
5.1.2. Configuration of serial SONO-interface	30
5.1.3. Set analogue outputs of the SONO probe	30
5.1.4. Configuration of Measure Mode.....	31
5.1.5. Setting the precision of a single value measurement cycle	32
5.1.6. Selection of the individual Calibration Curves	33
5.1.7. Test run in the respective Measurement Mode	34
5.1.8. "Measure" Run in Datalogging-Operation	34
5.1.9. Basic Balancing in Air and Water.....	35
5.1.10. Offsetting the material temperature sensor	36
5.1.11. Compensation of the electronic temperature	36
6. Technical Data SONO-ES SILO	37
7. Safety Notes	39

1. Instrument Description SONO-ES

1.1.1. The patented TRIME® TDR-Measuring Method

The TDR technology (Time-Domain-Reflectometry) is a radar-based dielectric measuring procedure at which the transit times of electromagnetic pulses for the measurement of dielectric constants, respectively the moisture content are determined.

SONO-ES consists of the measurement transformer SONO-ES and the probe head SILO-ES in a high grade steel casing with a wear-resistant sensor head with ceramic window. An integrated TRIME TDR measuring transducer is installed into the SONO-ES casing. A high frequency TDR pulse (1GHz), passes along wave guides and generates an electro-magnetic field around these guides and herewith also in the material surrounding the probe. Using a new patented measuring method, IMKO has achieved to measure the transit time of this pulse with a resolution of 1 picosecond (1×10^{-12}), consequently determine the moisture and the conductivity of the measured material.

The established moisture content, as well as the conductivity, respectively the temperature, can either be uploaded directly into a SPC via two analogue outputs 0(4) ...20 mA or recalled via a serial RS485 interface.

1.1.2. TRIME® compared to other Measuring Methods

In contrary to conventional capacitive or microwave measuring methods, the TRIME® technology (Time-Domain-Reflectometry with Intelligent Micromodule Elements) does not only enable the measuring of the moisture but also to verify if the mineral concentration specified in a recipe has been complied with. This means more reliability at the production.

TRIME-TDR technology operates in the ideal frequency range between 600MHz and 1,2 GHz.

Capacitive measuring methods (also referred to as Frequency-Domain-Technology), depending on the device, operate within a frequency range between 5MHz and 40MHz and are therefore prone to interference due to disturbance such as the temperature and the mineral contents of the measured material. Microwave measuring systems operate with high frequencies >2GHz. At these frequencies, nonlinearities are generated which require very complex compensation. For this reason, microwave measuring methods are more sensitive in regard to temperature variation.

SONO probes calibrate themselves in the event of abrasion due to a novel and innovative probe design. This consequently means longer maintenance intervals and, at the same time, more precise measurement values.

The modular TRIME technology enables a manifold of special applications without much effort due to the fact that it can be variably adjusted to many applications.

1.1.3. Areas of Application with SONO-ES SILO

The SONO-ES SILO system is suited for installation into containers, hoppers and silos.

The SILO-ES probe head is suited for measuring of normal abrasive materials. The probe head consists of stainless steel with a rectangular ceramic window. The special radar cable is made of PTFA and therefore temperature stable up to 150°C. The temperature range for the SONO-ES measurement transformer should not be higher than 80°C.

1.2. Mode of Operation

1.2.1. Measurement value collection with pre-check, average value and filtering

SONO probes measure internally at very high cycle rates of 10 kHz and update the measurement value at a cycle time of 280 milliseconds at the analogue output. In these 280 milliseconds a probe-internal pre-check of the moisture value is already carried out, i.e. only plausible and physically checked and pre-averaged single measurement values are used for the further data processing. This increases the reliability for the recording of the measured values to a downstream programmable control system PLC significantly.

In the **Measurement Mode CS** (Cyclic-Successive), an average value is not accumulated and the cycle time here is 200 milliseconds. In the **Measurement Mode CA, CF, CH, CC and CK**, not the momentarily measured individual values are directly issued, but an average value is accumulated via a variable number of measurements in order to filter out temporary variations. These variations can be caused by inhomogeneous moisture distribution in the material surrounding the sensor head. The delivery scope of SONO probes includes suited parameters for the averaging period and a universally applicable filter function deployable for currently usual applications. The time for the average value accumulation, as well as various filter functions, can be adjusted for special applications.

1.2.2. Determination of the mineral concentration with EC-TRIME

With the radar-based TRIME measurement method, it is now possible for the first time, not only to measure the moisture, but also to provide information regarding the conductivity, respectively the mineral concentration or the composition of a special material. Hereby, the attenuation of the radar pulse in the measured volume fraction of the material is determined. This novel and innovative measurement delivers a radar-based conductance value (EC-TRIME) in dS/m as characteristic value which is determined in dependency of the mineral concentration and is issued as an unscaled value. The EC-TRIME measurement range of the SONO probe is 0..12dS/m

1.2.3. Material Temperature Measurement

A temperature sensor is installed into the SONO-probe which establishes the casing temperature 3mm beneath the sensor surface. The temperature can optionally be issued at the analogue output². As the TRIME electronics operates with a power of approximately 1.5 W, the probe casing does slightly heat up. A measurement of the material temperature is therefore only possible to a certain degree. The material temperature can be determined after an external calibration and compensation of the sensor self-heating. The offset of the measured temperature value can be adjusted with help of the program SONO-CONFIG.

Despite SONO probes show a generally low temperature drift, it could be necessary to compensate a temperature drift in special applications. SONO probes offer two possibilities for temperature compensation.

Temperature compensation for the measured material

Water and special materials like oil fruits and others, can show a dependency of the dielectric permittivity when using SONO probes at high temperature ranges. The dielectric permittivity is the raw parameter for measuring water content with SONO probes. If special materials show a very special temperature drift, e.g. in lower temperatures a higher drift than in higher temperatures, than it could be necessary to make a more elaborate temperature compensation. Therefore it is necessary to measure in parallel the material temperature with the temperature sensor which is placed inside the SONO probe. Normally this is related with high efforts in laboratory works. SONO probes offer the possibility to set special temperature compensation parameters t0 to t5 for every calibration curve Cal1 of Cal15 (see chapter "Selection of the individual calibration curve"). Please contact IMKO should you need any assistance in this area.

1.2.4. Temperature compensation of the internal SONO-electronic

With this method of temperature compensation, a possible temperature drift of the SONO-electronic can be compensated. Because the SONO-electronic shows a generally low temperature drift, SONO probes are presetted at delivery for standard ambient conditions with the parameter **TempComp=0.2**.

Dependent on SONO probe type, this parameter TempComp can be adjusted for higher temperature ranges (up to 120°C for special version) to values up to **TempComp=0.75**. But it is to consider that it is necessary to make a Basic-Balancing of the SONO probe in air and water, if the parameter TempComp is changed to another value as TempComp=0.2. The parameter TempComp can be changed with the software tool SONO-CONFIG, in the menu "**Calibration**" and the window "**Electronic-Temperature-Compensation**".



Attention: When changing the TempComp parameter, a new basic balancing of the SONO probe is necessary!

1.2.5. Analogue Outputs

The measurement values are issued as a current signal via the analogue output. With the help of the service program **SONO-CONFIG**, the SONO probe can be set to the two versions for 0..20mA or 4..20mA. Furthermore, it is also possible to variably adjust the moisture dynamic range e.g. to 0-10%, **0-20%** or 0-30%. For a 0-10V DC voltage output, a 500R resistor can be installed in order to reach a 0..10V output.

Analogue Output 1: Moisture in % (0...20%, variable adjustable)

Analogue Output 2: Conductivity (EC-TRIME) or optionally the temperature.

In addition, there is also the option to split the analogue output 2 into two ranges: into 4..11mA for the temperature and 12..20mA for the conductivity. The analogue output two hereby changes over into an adjustable one-second cycle between these two (current) measurement windows.

For the analogue outputs 1 and 2 there are thus two adjustable options:

Analogue Output: (two possible selections)

0..20mA

4..20mA

For very special PLC applications, the current output can be inverted into:

20mA...0mA or **20mA...4mA**

Analogue Output Channel 1 and 2: The two analogue outputs of the SONO probe can be adjusted into one to four possible selections.

1. Moist, Temp	Analogue output 1 for moisture, output 2 for material temperature.
2. Moist, Conduct	Analogue output 1 for moisture, output 2 for conductivity in ranges of 0..20dS/mS or 50dS/m
3. Moist, Temp/Conductivity	Analogue output 1 for moisture, output 2 for both, temperature and conductivity (EC-TRIME) with an automatic current-window change in cycles of 5 seconds.
4. Moist / MoistSTdDev	Analogue output 1 for moisture, output 2 for the standard deviation based on the single moisture values. This function is useful in e.g. fluid bed drier for air volume control.

Adjustment for the Measurement Ranges

For analogue output 1 and 2 the moisture dynamic range and temperature dynamic range can be variably adjusted. The moisture dynamic range should not exceed 100%

Moisture Range:

Maximum: e.g. 20 for sand (Set in %)

Minimum: 0

Temp. Range:

Maximum: 70 °C

Minimum: 0 °C

Conductivity Range: 0..20dS/m or 0...50dS/m

Dependent on probe type and moisture range, SONO probes can measure pore water conductivities (EC-TRIME) in ranges of 5dS/m up to 50dS/m.

1.3. The serial RS485 and IMP-Bus interface

SONO-probes are equipped with a standard RS485 as well as the IMP-Bus interface to set and readout individual parameters or measurement values. An easy to implement data transfer protocol enables the connection of several sensors/probes at the RS485-Interface. In addition, SONO-probes can be directly connected via the module SM-USB or the display module SONO-VIEW to the USB port of a PC, in order to adjust individual measuring parameters or conduct calibrations.

Please consider: The initial default setting of the serial interface is pre-set for the IMP-Bus. To operate with the RS485 inside the SONO-probe, it is necessary to switch and activate the RS485 interface with help of the modul SM-USB or SONO-VIEW.

1.3.1. The IMP-Bus as a user friendly network system

With external power supply on site for the SONO probes, a simple 2-wire cable can be used for the networking. By use of 4-wire cables, several probes can be also supplied with power.

Standard RS485-interfaces cause very often problems! The RS485 is usually not galvanically isolated and therefore raises the danger of mass grindings or interferences which can lead to considerably security problems. An RS485 network needs shielded and twisted pair cables, especially for long distances. Depending on the topology of the network, it is necessary to place 100Ohm termination resistors at sensitive locations. In practice this means considerable specialist effort and insurmountable problems.

The robust IMP-Bus ensures security. SONO-probes have in parallel to the standard RS485 interface the robust galvanically isolated IMP-Bus which means increased safety. The serial data line is isolated from the probe's power supply and the complete sensor network is therefore independent from single ground potentials and different grid phases. Furthermore the IMP-Bus transmit its data packets not as voltage signals, but rather as current signals which also works at already existing longer cables. A special shielded cable is not necessary and also stub lines are no problem.

1.3.2. Error Reports and Error Messages

SONO probes are very fault-tolerant. This enables failure-free operation. Error messages can be recalled via the serial interface.

2. Configuration of the Measure Mode

The configuration of SONO- probe is preset in the factory before delivery. A process-related later optimisation of this device-internal setting is possible with the help of the service program **SONO-CONFIG**. For all activities regarding parameter setting and calibration the probe can be directly connected via the serial interface to the PC with SM-USB-Module or the SONO-VIEW display module which are available from IMKO.

The following settings of SONO probes can be amended with the service program **SONO-CONFIG**:

Measurement-Mode and Parameters:

- Measurement Mode A-On-Request (only in network operation for the retrieval of measurement values via the serial interface).
- Measurement Mode C Cyclic:
SONO-VARIO is supplied ex-factory with suited parameters in **Mode CH** for measuring moisture of sand and gravel. For other applications, mode CA could be usable. Up to 6 different modes can be adjusted:

Mode CS: (Cyclic-Successive) For very short measuring processes (e.g. 2...10 seconds) without floating average and without filter functions, with internal up to 100 measurements per second and a cycle time of 250 milliseconds at the analogue output. Measurement mode CS can also be used for getting raw data from the SONO-probe without averaging and filtering.

Mode CA: (Cyclic-Average-Filter) For relative short measuring processes with continual average value, filtering and an accuracy of up to 0.1%

Mode CF: (Cyclic-Float-Average) for continual average value with filtering and an accuracy of up to 0.1% for very slowly measuring processes, e.g. in fluidized bed dryers, conveyor belts, etc.

Mode CK: (Cyclic-Kalman-Filter with Boost) Standard setting for SONO-MIX for use in fresh concrete mixer with continual average value with special dynamic Kalman filtering and an accuracy of up to 0.1%.

Mode CC: (Cyclic Cumulated) with automatic summation of a moisture quantity during one batch process.

Mode CH: (Cyclic Hold) similar to Mode CC but without summation.

Mode CH is recommended for applications in the construction industry. If the SONO-probe is installed under a silo flap, Mode CH can measure moisture when batch cycles are very short, down to 2 seconds. Mode CH executes an automatic filtering, e.g. if dripping water occurs.

- Precision of a single TDR radar pulse measurement (see in chapter „Software tool SONO-CONFIG“ under point „Setting the precision of a single value measurement“).

Each of these settings will be preserved after shut down of the probe and is therefore stored on a permanent basis.

2.1. Cyclic operation modes CA, CF, CH, CC and CK

For the cyclic modes the SONO probes are supplied ex-factory with suited parameters for the averaging time and with a universally deployable filter function suited for most currently applications.

The setting options and special functions of SONO probes depicted in this chapter are only rarely required. It is necessary to take into consideration that the modification of the settings or the realisation of these special functions may lead to faulty operation of the probe!

For applications with non-continuous material flow, there is the option to optimise the control of the measurement process via the adjustable filter values *Filter-Lower-Limit*, *Filter-Upper-Limit* and the time constant *No-Material-Keep-Time*. The continual/floating averaging can be set with the parameter *Average-Time*.

Function	
Parameters in the Measurement Mode CA, CF, CC, CH and CK	
<p>Average-Time Standard Setting: 2s Setting Range: 1...20 Unit: Seconds</p>	<p>CA/CF: Time (in seconds) for the generation of the average value can be set with this parameter.</p> <p>CC/CH/CK: Setting of the time for calculation of the trend or expectation value for the Boost & Offset function.</p>
<p>Filter-Upper-Limit-Offset Standard Setting: 25% Setting Range: 1...20 Unit: % Absolut</p>	<p>CA/CC/CF/CH/CK: Too high measurement values generated due to metal wipers or blades are filtered out. The offset value in % is added to the dynamically calculated upper limit.</p>
<p>Filter-Lower-Limit-Offset Standard Setting: 25% Setting Range: 1...20! Unit: % Absolut</p>	<p>CA/CC/CF/CH/CK: Too low measurement values generated due to insufficient material at the probe head are filtered out. The offset value in % is subtracted from the dynamically calculated lower limit with the negative sign.</p>
<p>Upper-Limit-Keep-Time Standard Setting: 10 Setting Range: 1...100 Unit: % Absolut</p>	<p>CA/CC/CF/CH/CK: The maximum duration (in seconds) of the filter function for Upper-Limit-failures (too high measurement values) can be set with this parameter.</p>
<p>Lower-Limit-Keep-Time Standard Setting: 10 Setting Range: 1...100s Unit: Seconds</p>	<p>CA/CC/CF/CH/CK: The maximum duration (in seconds) of the filter function for Lower-Limit-failures (too low measurement values) for longer-lasting "material gaps", ie the time where no material is located on the probe's surface can be bridged.</p>
<p>Moisture Threshold (start threshold in %-moisture) Standard Setting: 0.1% Setting Range: 0...100% Unit: % Absolut</p>	<p>CA/CF/CK: inactive</p> <p>CC/CH: The accumulation of moisture values starts above the „Moisture Threshold“ and from here the analogue signal is outputted. The accumulation pauses and will be frozen if the moisture level is below the threshold value. The No-Material-Delay time starts and material gaps (disturbance) can be eliminated.</p>
<p>No-Material-Delay (period time) Standard Setting: 10s Setting Range: 1...100s Unit: Seconds</p>	<p>CA/CF/CK: inactive</p> <p>CC/CH: The accumulation stops if the moisture value is below the Moisture Threshold. The accumulation pauses for the period of the setted delay time and will be frozen if the moisture level is below the threshold value. The SONO probes starts again in a new batch with a new accumulation after the setted time span of the "No-Material-Delay" is completely exceeded.</p>
<p>Boost Standard Setting: 35nn Setting Range: 1...100nn Unit: without unit!</p>	<p>CA/CF: inactive</p> <p>CC/CH/CK: Defines, how strong single measurement values are weighted dependent on deviation to the current expected average value. With e.g. Boost=35, a single measurement value is weighted with only 65% (100-35) for a new average value.</p>
<p>Offset Standard Setting: 0.5% Setting Range: 0...5% Unit: % Absolut</p>	<p>CA/CF: inactive</p> <p>CC/CH/CK: Non-linearities in the process can be compensated by higher weighting of higher values. Can be used e.g. in fluid bed dryers or under silo flaps where non-linearities can occur due to changes in the material density during process. "Offset" works together with the parameter "Average-time".</p>
<p>Weight Standard Setting: 5 values Setting Range: 0...50 Unit: Measurement Values</p>	<p>CA/CF/CK: inactive</p> <p>CH: Smoothing factor for analog output setting. This parameter influences the reaction/response time with factor 3. E.g. 15 values responds to a reaction time of 15/3=5 seconds.</p> <p>CK: The reaction/response time works nearly 1:1. E.g. 15 values responds to a reaction time of 15 seconds.</p>

<p>Invalid Measure Count Standard Setting: 2 values Setting Range: 0..... 10 Unit: Measurement Values with 3 single values per second.</p>	<p>CA/CF/CK: inactive CC/CH: Number of discarded (poor) measurement values after the start of a new batch, when „No-Material-Delay“ has triggered. The first measurement values will be rejected, e.g. due to dripping water.</p>
<p>Moisture Std. Deviation Count Standard Setting: 5 values Setting Range: 0..... 20 Unit: Measurement Values with 3 single values per second.</p>	<p>CA/CC/CF/CH/CK: If the parameters Temperature or EC-TRIME (RbC) are not needed, the analogue output 2 can be set to the mode Moist/Moist Std. Deviation. In this mode the standard deviation of all single moisture values can be outputted. With this function the homogeneity of the single measurement values can be determined and it is possible to control a regulating process, e.g. pressure regulation.</p>
<p>Quick und Quick-Precision With Meas Time (no. values) Unit: without unit!</p>	<p>CA/CC/CF/CH/CK/CS: Recommended is Quick Precision with Meas Time=2 where the TDR pulse is detected precisely. For still a little better accuracies, Meas Time can be increased, however the single measurement cycle is increased by 60 milliseconds per step (e.g. from 280ms to 340ms). Older SONO probe versions do not have this Quick Precision function!</p>

2.1.1. Average Time in the measurement mode CA and CF

SONO probes establish every 200 milliseconds a new single measurement value which is incorporated into the continual averaging and issues the respective average value in this timing cycle at the analogue output. The averaging time therefore accords to the “memory” of the SONO probe. The longer this time is selected, the more inert is the reaction rate, if differently moist material passes the probe. A longer averaging time results in a more stable measurement value. This should in particular be taken into consideration, if the SONO probe is deployed in different applications in order to compensate measurement value variations due to differently moist materials.

At the point of time of delivery, the *Average Time* is set to 4 seconds. This value has proven itself to be useful for many types of applications. At applications which require a faster reaction rate, a smaller value can be set. Should the display be too “unstable”, it is recommended to select a higher value.

2.1.2. Filtering at material gaps in mode CA and CF

A SONO probe is able to identify, if temporarily no or less material is at the probe head and can filter out such inaccurate measurement values (**Filter-Lower-Limit**). Particular attention should be directed at those time periods in which the measurement area of the probe is only partially filled with material for a longer time, i.e. the material (sand) temporarily no longer completely covers the probe head. During these periods (**Lower-Limit-Keep-Time**), the probe would establish a value that is too low. The **Lower-Limit-Keep-Time** sets the maximum possible time where the probe could determine inaccurate (too low) measurement values.

Furthermore, the passing or wiping of the probe head with metal blades or wipers can lead to the establishment of too high measurement values (**Filter-Upper-Limit**). The **Upper-Limit-Keep-Time** sets the maximum possible time where the probe would determine inaccurate (too high) measurement values.

Using a complex algorithm, SONO probes are able to filter out such faulty individual measurement values. The standard settings in the **Measurement Mode CA and CF** for the filter functions depicted in the following have proven themselves to be useful for many applications and should only be altered for special applications.

It is appropriate to bridge material gaps in mode CA with Upper- and Lower-Limit Offsets and Keep-Time. For example the Lower-Limit Offset could be adjusted with 2% with a Lower-Limit Keep-Time of 5 seconds. If the SONO probe determines a moisture value which is 2% below the average moisture value with e.g. 8%, then the average moisture value will be frozen at this value during the Lower-Limit Keep-Time of 5 seconds. In this way the material gap can be bridged. This powerful function inside the SONO probe works here with a highpass filter where the higher moisture values are used for building an

average value, and the lower or zero values are filtered out. In the following this function is described with SONO parameters.

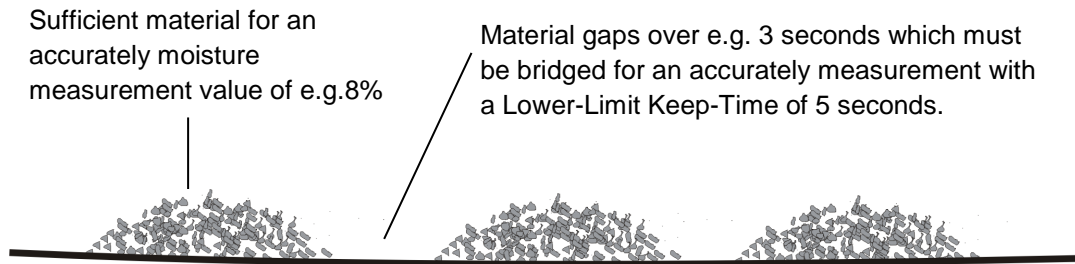

The following parameter setting in mode CA fits a high pass filtering for bridging material gaps.

Average Mode under Mode C	
CA-Cyclic Average	
Average Parameters:	
Average Time(s)	1
Filter Upper Limit Offset	20
Filter Lower Limit Offset	2
Upper Limit Keep Time	10
Lower Limit Keep Time	5

The Filter Upper-Limit is here deactivated with a value of 20, the Filter Lower-Limit is set to 2%. With a Lower-Limit Keep-Time of 5 seconds the average value will be frozen for 5 seconds if a single measurement value is below the limit of 2% of the average value. After 5 seconds the average value is deleted and a new average value building starts. The Keep-Time function stops if a single measurement value lies within the Limit values.

2.1.3. Mode CC – automatic summation of a moisture quantity during one batch process

Simple PLCs are often unable to record moisture measurement values during one longer batch process with averaging and data storage. Furthermore there are applications without a PLC, where accumulated moisture values of one batch process should be displayed to the operating staff for a longer time. Previously available microwave moisture probes on the market show two disadvantages:

1. Such microwave probes need a switching signal from a PLC for starting the averaging of the probe. This increases the cabling effort.
2. Material gaps during one batch process will lead to zero measurement values which falsify the accumulated measurement value considerably, recipe errors can occur.

Unlike current microwave probes, SONO probes work in mode CC with automatic summation, where it is really ensured that the measured material has contact with the probe. This increases the reliability for the moisture measurement during one complete batch process. The summation is only working if material fits at the probe. Due to precise moisture measurement also in the lower moisture range, SONO probes can record, accumulate and store moisture values during a complete batch process without an external switching or trigger signal. The SONO probe “freezes” the analogue signal as long as a new batch process starts. So the PLC has time enough to read in the “frozen” moisture value of the batch. For applications without a PLC the “frozen” signal of the SONO probe can be used for displaying the moisture value to a simple 7-segment unit as long as a new batch process will start.

With the parameter **Moisture Threshold**, the SONO probe can be configured to the start moisture level where the summation starts automatically. Due to an automatic recalibration of SONO probes, it is ensured that the zero point will be precisely controlled. The start level could be variably set dependent to the plant. Recommended is a level with e.g. 0.5% to 1%.

With the parameter **No-Material-Delay** a time range can be set, where the SONO probe is again ready to start a new batch process. Are there short material gaps during a batch process which are shorter than the "No-Material-Delay", with no material at the probes surface, then the SONO probe pauses shortly with the summation. Is the pause greater as the "No-Material-Delay" then the probe is ready to start a new batch process.

Please note: If the PLC already accumulates single moisture values in higher cycle rates, than an additional automatic summation of a moisture quantity inside the SONO-probe during one batch process will produce errors. Here mode CS is recommended.

How can the mode CC be used, if the SONO probe cannot detect the „moisture threshold“ by itself, e.g. above a conveyor belt if there is constant material covering above the probe head over a longer time: In this case, a short interrupt of the probe's power supply, e.g. for about 0.5 seconds with the help of a relay contact of the PLC, can restart the SONO probe at the beginning of the material transport. After this short interrupt the SONO probe starts immediately with the summarizing and averaging.

Please note: It should be noted that no material sticks on the probes surface. Otherwise the moisture zero point detection of the probe will be shifted up and the probe would not be detect a moisture low value below the "Moisture-Threshold".

Time chart for mode CC

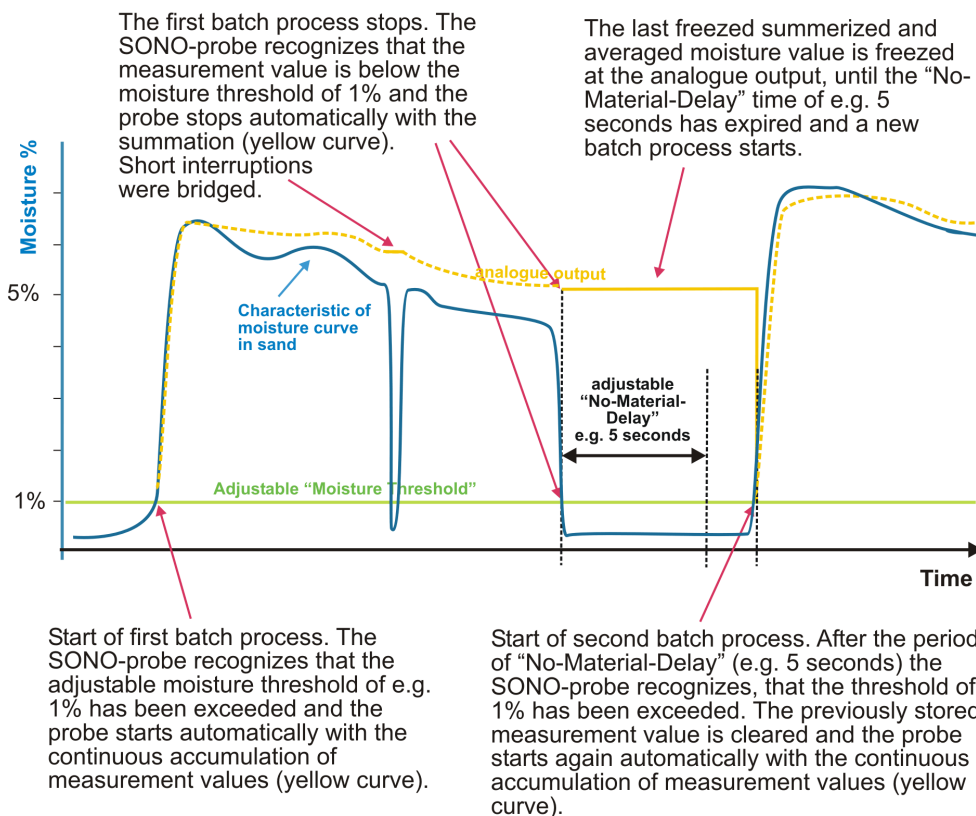

2.1.4. Mode CH – Automatic Moisture Measurement in one Batch

Mode CH can be used for applications in the construction industry. If the SONO-probe is installed under a silo flap, **Mode CH** can measure moisture when batch cycles are very short, down to 5 seconds (and perhaps shorter). Mode CH executes an automatic filtering with **Invalid Measure Count**, e.g. if dripping water occurs or for filtering out the first false measurements after opening the silo flap. The measurement cycle starts if the probe detects the **Moisture Threshold** value and freeze the analogue output value until the next cycle.

Mode CH (Cyclic Hold) is identically to Mode CC but without summation.

2.2. Overview of single modes for different applications

The following table gives an overview about possible parameter settings in different modes:

<i>Application/ Installation and specific Parameters</i>	<i>Sand/ Gravel under a silo flap</i>	<i>Above a conveyor belt</i>	<i>Inside a mixer</i>	<i>Inside a fluid bed dryer</i>	<i>Gene- rally simple appli- cations</i>	<i>in a screw conveyor with filtering options due to metal spiral</i>	<i>At the end of a screw conveyor</i> <i>Long term process</i>
<i>Operating Mode</i>	CH	CH	CK	CK	CA	CK	CF
<i>Average- Time</i>	2	2	5	5	10	10	30
<i>Filter- Upper-Limit Offset</i>	inactiv 100	inactiv 100	inactiv 100	inactiv 100	e.g. 20	inactiv 100	e.g. 20
<i>Filter- Lower-Limit Offset</i>	inactiv 100	inactiv 100	inactiv 100	inactiv 100	e.g. 10	inactiv 100	e.g. 5
<i>Upper- Limit-Keep- Time</i>	inactiv 10	inactiv 10	inactiv 10	inactiv 10	e.g. 10	inactiv 10	e.g. 10
<i>Lower- Limit-Keep- Time</i>	inactiv 10	inactiv 10	inactiv 10	inactiv 10	e.g. 10	inactiv 10	e.g. 10
<i>Moisture Threshold</i>	0.1	0.1	0.1	0.1	-	0.1	-
<i>No-Material- Delay</i>	10	10	10	10	-	inactiv	-
<i>Boost</i>	35	35	20	20	-	20	-
<i>Offset</i>	0.5	0.5	1	1	-	1	-
<i>Weight</i>	5	5	25	25	-	50	-
<i>Invalid Measure Count</i>	2	2	inactiv	inactiv	-	inactiv	-

For very difficult applications, where it is not certain which mode is the best inside the SONO-probe, we recommend to select **mode CA** with averaging time = 1 second. With help of the software SONO-CONFIG a data record can be stored directly during process conditions. After forwarding this data set to IMKO, we would be pleased to be at your disposal for finding the best suitable working mode.

2.3. Calibration Curves

SONO-ES is supplied with a universal calibration curve for sand (Cal1: Universal Sand Mix). A maximum of 15 different calibration curves (CAL1 ... Cal15) are stored inside the SONO probe and can optionally be activated via the program **SONO-CONFIG**.

A preliminary test of an appropriate calibration curve (Cal1. .15) can be activated in the menu "**Calibration**" and in the window "**Material Property Calibration**" by selecting the desired calibration curve (Cal1...Cal15) and with using the button "**Set Active Calib**". The finally desired and possibly altered calibration curve (Cal1. .15) which is activated after switching on the probes power supply will be adjusted with the button "**Set Default Calib**".

Nonlinear calibrations are possible with polynomials up to 5th grade (coefficients m0...m5).

IMKO publish on its website more suitable calibration coefficients for different materials. These calibration coefficients can be entered and stored in the SONO probe by hand (Cal14 and Cal15) with the help of SONO-CONFIG.

The following charts (Cal.1 .. 15) show different selectable calibration curves which are stored inside the SONO probe.

Plotted is on the y-axis the gravimetric moisture (**MoistAve**) and on the x-axis depending on the calibration curve the associated radar time **tpAve** in picoseconds. With the software **SONO-CONFIG** the radar time **tpAve** is shown on the screen parallel to the moisture value **MoistAve** (see "Quick Guide for the Software SONO-CONFIG).

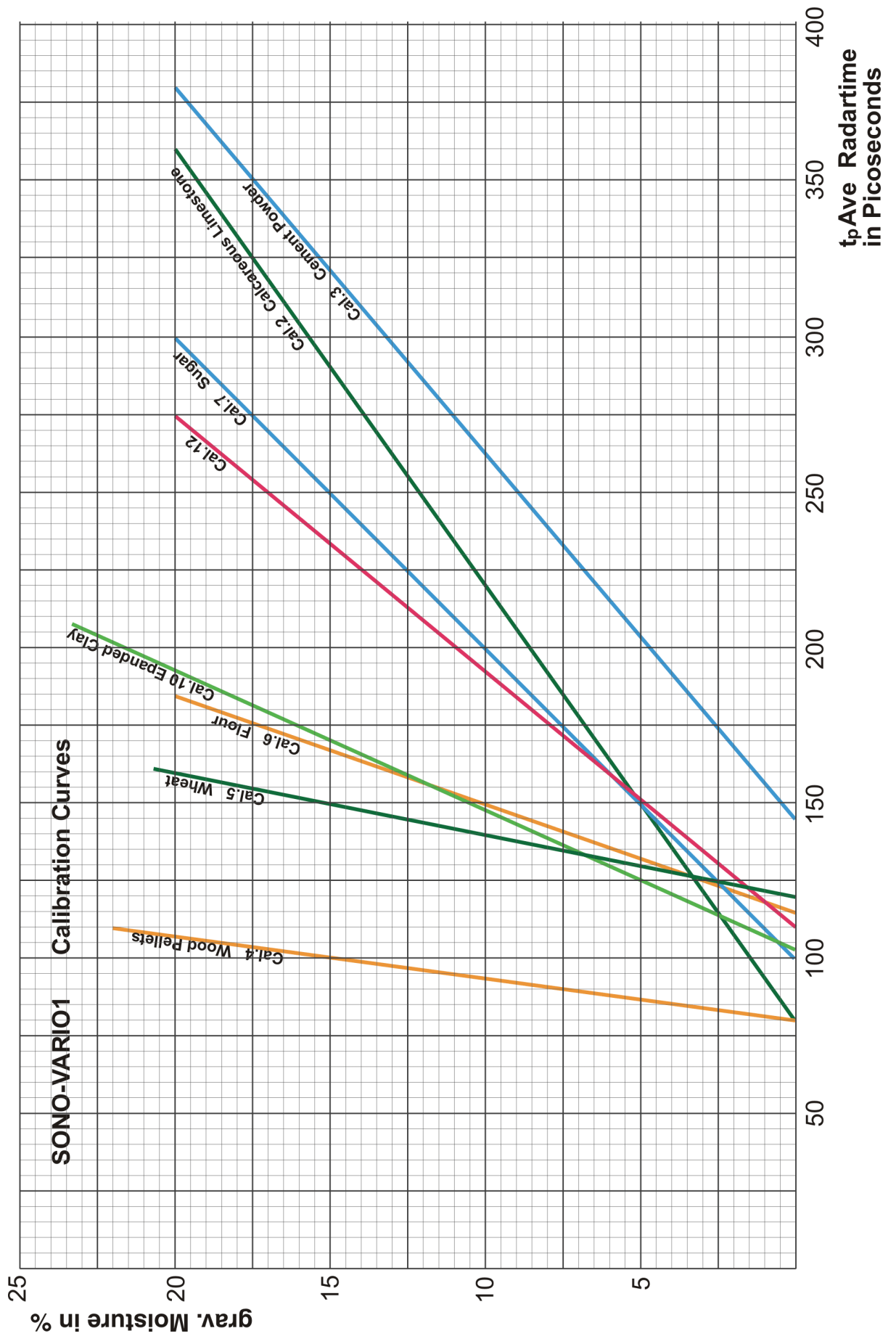

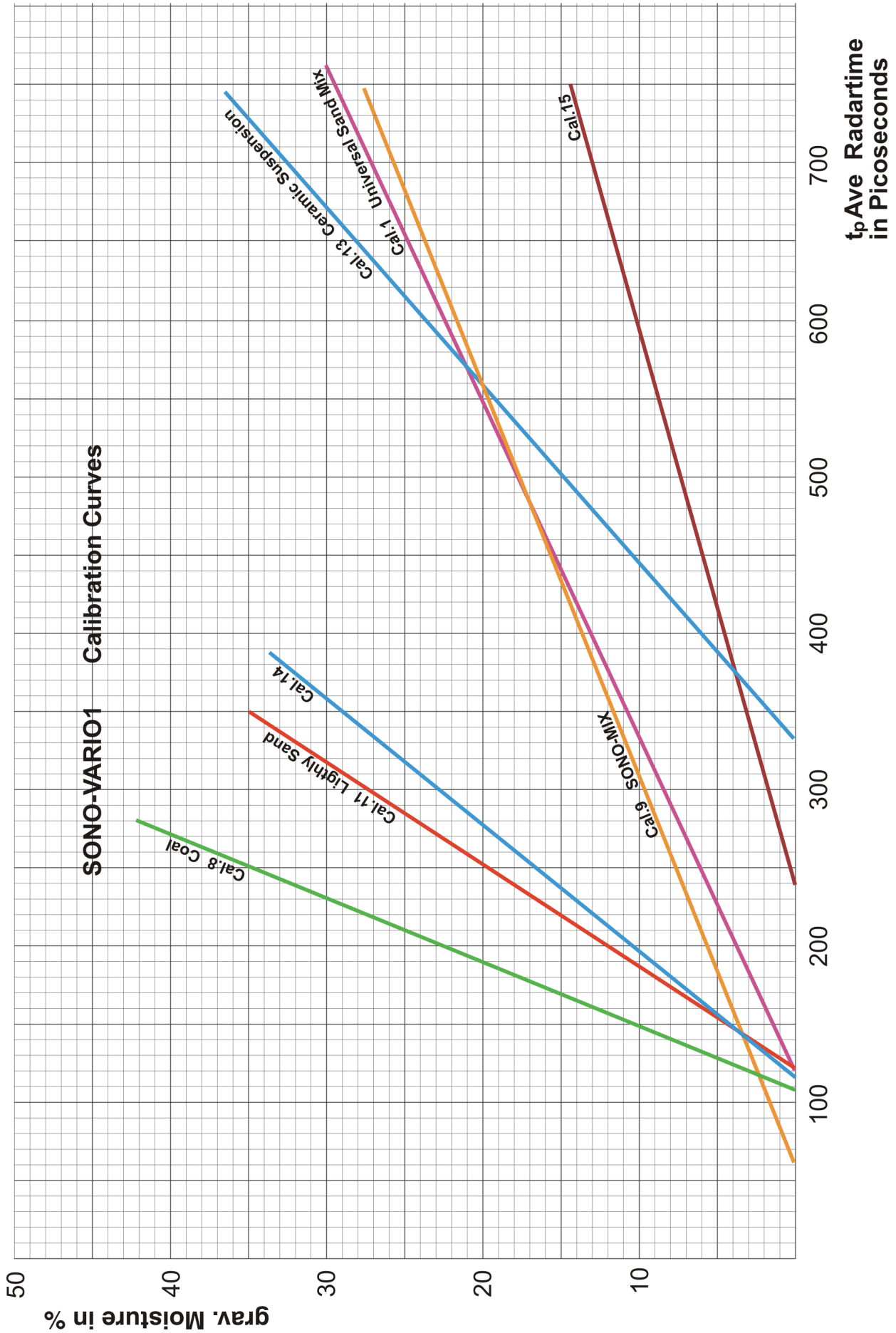

2.3.1. SONO-ES for measuring Moisture of Sand and Aggregates

The TRIME-TDR technology with the radar method offers high reliability for measuring moisture of sand and aggregates, as different grain sizes, unlike other measurement techniques such as microwave technology, do not cause any distortion of the measurement result.

The calibration curve Cal1 "Universal Sand Mix" is suitable for measuring the moisture in bulk sand, gravel and gravel/sand granulates. The deviations to the universal calibration curve Cal1 are approximately +/-0.5%, depending on the moisture range, for the below listed gravel/sand types.

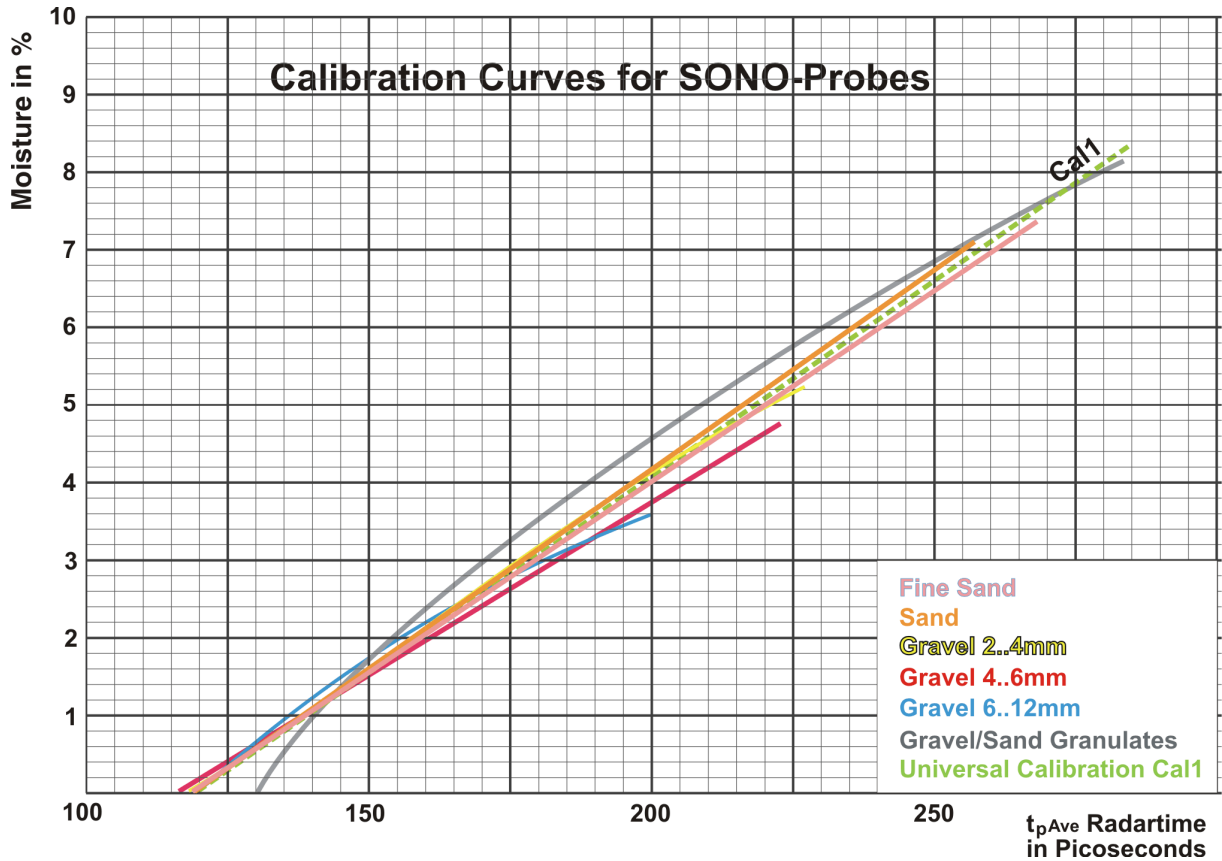

Fine Sand

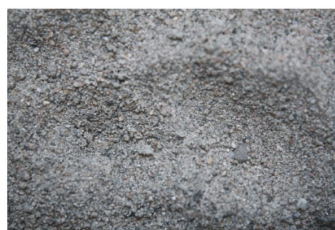

Sand

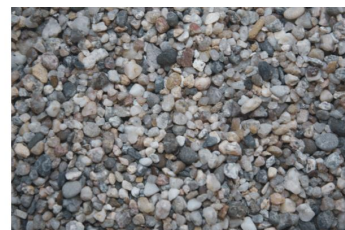

Gravel 2..4mm

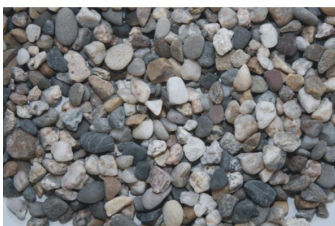

Gravel 4..6mm

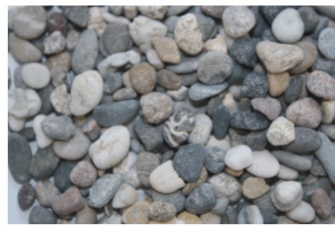

Gravel 6..12mm



Gravel/Sand Granulates

2.4. Creating a linear Calibration Curve for a specific Material

The calibration curves Cal1 to Cal15 can be easily created or adapted for specific materials with help of SONO-CONFIG. Therefore, two measurement points need to be identified with the probe. **Point P1 at dried material** and **point P2 at moist material** where the points P1 and P2 should be far enough apart to get a best possible calibration curve. The moisture content of the material at point P1 and P2 can be determined with laboratory measurement methods (oven drying). It is to consider that sufficient material is measured to get a representative value.

Under the menu "**Calibration**" and the window "**Material Property Calibration**" the calibration curves CAL1 to Cal15 which are stored in the SONO probe are loaded and displayed on the screen (takes max. 1 minute). With the mouse pointer individual calibration curves can be tested with the SONO-probe by activating the button "**Set Active Calib**". The measurement of the moisture value (**MoistAve**) with the associated radar time **tpAve** at point P1 and P2 is started using the program SONO-CONFIG in the sub menu "**Test**" and "**Test in Mode CF**" (see "Quick Guide for the Software SONO- CONFIG").

Step 1: The radar pulse time **tpAve** of the probe is measured with dried material. Ideally, this takes place during operation of a mixer/dryer in order to take into account possible density fluctuations of the material. It is recommended to detect multiple measurement values for finding a best average value for **tpAve**. The result is the first calibration point P1 (e.g. 70/0). I.e. 70ps (picoseconds) of the radar pulse time **tpAve** corresponds to 0% moisture content of the material. But it would be also possible to use a higher point P1' (e.g. 190/7) where a **tpAve** of 190ps corresponds to a moisture content of 7%. The gravimetric moisture content of the material, e.g. 7% has to be determined with laboratory measurement methods (oven drying).

Step 2: The radar pulse time **tpAve** of the probe is measured with moist material. Ideally, this also takes place during operation of a mixer/dryer. Again, it is recommended to detect multiple measurement values of **tpAve** for finding a best average value. The result is the second calibration point P2 with X2/Y2 (e.g. 500/25). I.e. **tpAve** of 500ps corresponds to 25% moisture content. The gravimetric moisture content of the material, e.g. 25% has to be determined with laboratory measurement methods (oven drying).

Step 3: With the two calibration points P1 and P2, the calibration coefficients m_0 and m_1 can be determined for the specific material (see next page).

Step 4: The coefficients $m_1 = 0.0581$ and $m_0 = -4.05$ (see next page) for the calibration curve Cal14 can be entered directly by hand and are stored in the probe by pressing the button "**Set**". The name of the calibration curve can also be entered by hand. The selected calibration curve (e.g. Cal14) which is activated after switching on the probes power supply will be adjusted with the button "**Set Default Calib**".



Attention: Use "dot" as separator (0.0581) in SONO-CONFIG, not comma !

2.4.1. Calculation for a linear 2-point calibration curve

1. Download the Excel-Sheet „**SONO 2-Point LinearCalibration_Calculation**“ from IMKO's Homepage under „Support Software“.
2. Enter into the Excel-Sheet both TP-values with the respective reference moisture values.
3. Read out both parameters m_0 and m_1 from the Excel-Sheet.
4. Enter, set and save both parameters m_0 and m_1 with help of the software „SONO-CONFIG“ in the menu „**Calibration**“ in the window „**Material Property Calibration**“ in the selected calibration curve.

2.4.2. Calculation for a linear 1-point calibration curve

In practice during commissioning of a SONO probe in process, it could be happen that the measured material above the probe is only available with a single moisture value. So a 2-point calibration could not be carried out.

The procedure described below is not as precisely like a 2-point calibration, but it could be a compromise to achieve an acceptable result for a usable calibration curve.

Below you will find the basic steps which are necessary:

1. Measure the radar travel time **T_p** in the running process while the material lies or flows above the SONO probe's surface. **T_p** can be measured with help of the module **SM-USB** or with the display module **SONO-VIEW**.
2. Determine the reference moisture **M in %** of the measured material which lies above the SONO probe. Unless the material moisture is already known, the reference moisture can be determined with an infrared- or microwave oven in the laboratory.
3. Determine the bulk **density D** of the material in kg per dm³. Unless the bulk density is already known this can be done by weighing of exactly 1 liter volume of the material.
4. Download the Excel-Sheet „**SONO 1-Point LinearCalibration_Calculation**“ from IMKO's Homepage under „Support Software“. Enter the three determined parameters **T_p** (Radar travel time), **M** (Moisture) und **D** (bulk density) into the Excel-Sheet. As result you get the two calibration curve coefficients m0 and m1.
5. Enter, set and save both parameters m0 and m1 with help of the software „SONO-CONFIG“ in the menu „**Calibration**“ in the window „**Material Property Calibration**“ in the selected calibration curve. The three parameters **T_p**, **M** and **D** can be also entered without a PC with the module SONO-VIEW (see manual SONO-VIEW).

2.4.3. Calculation for a non-linear calibration curve

SONO probes can work also with non-linear calibration curves with polynomials up to 5th grade. For a non-linear calibration it is necessary to calibrate with 4...8 different calibration points with different T_p values and the related moisture values in %. To calculate nonlinear coefficients for polynomials up to 5th grade, an EXCEL software tool from IMKO can be used.

1. Download the Excel-Sheet „**SONO_NonlinearCalibration_Calculation**“ from IMKO's Homepage under „Support Software“.
2. Enter the TP-values with the respective reference moisture values into the Excel-Sheet.
3. Read out the parameters m0 to m5 from the Excel-Sheet.
4. Enter, set and save the parameters m0 to m5 in the selected calibration curve with help of the software „SONO-CONFIG“ in the menu „**Calibration**“ under the window „**Material Property Calibration**“.

2.5. Connectivity to SONO Probes

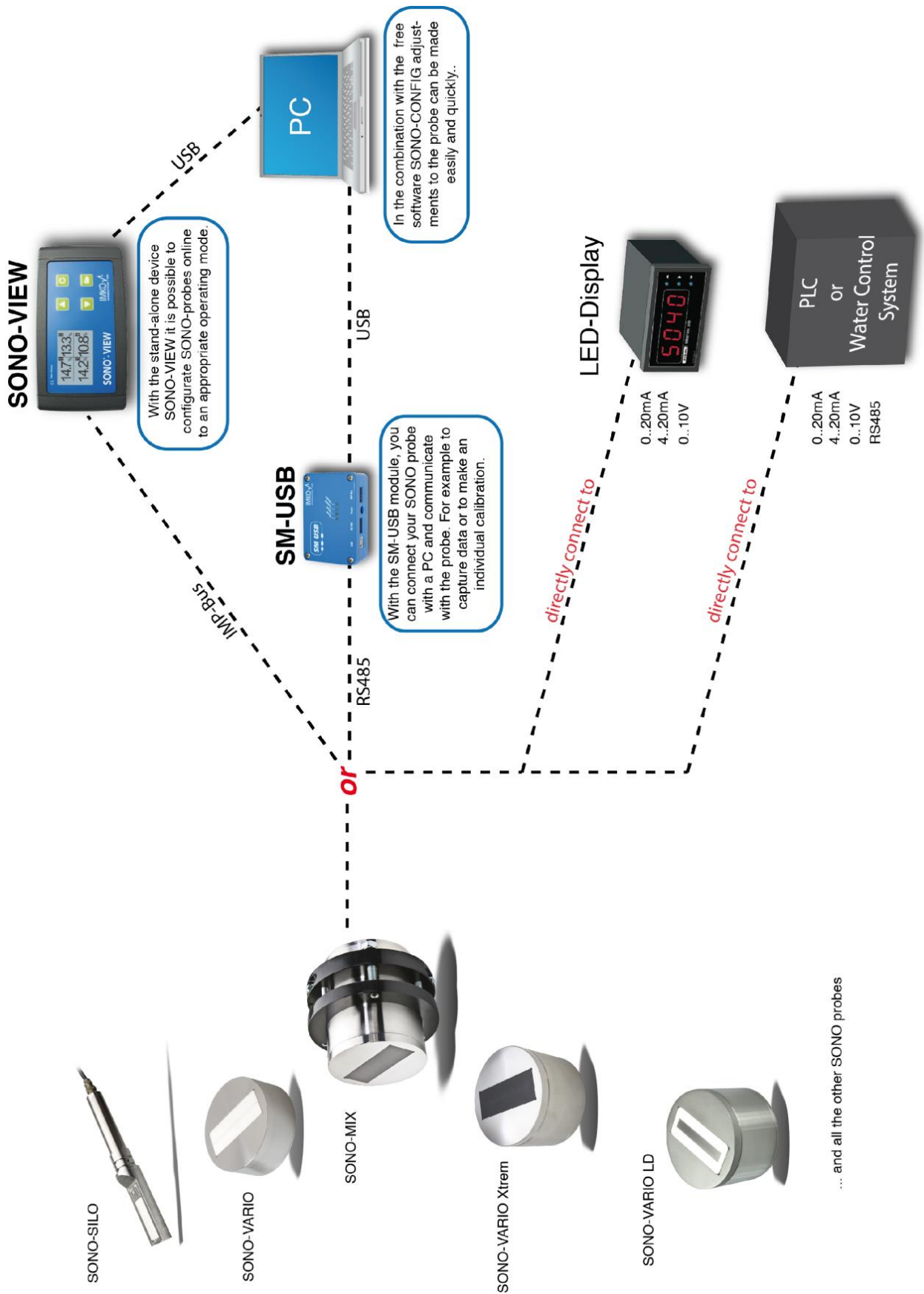

2.6. Connection Plug and Plug Pinning

SONO-ES is supplied with a 10-pole MIL flange plug.

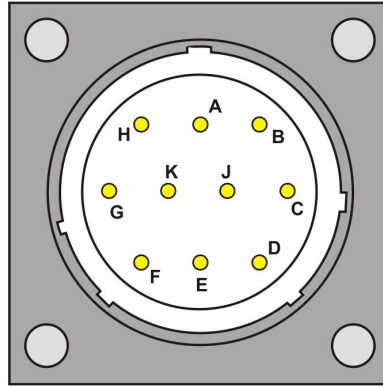

Assignment of the 10-pole MIL Plug and sensor cable connections:

Plug-PIN	Sensor Connections	Lead Colour	Lead Colour
A	+7V....24V Power Supply	red	red
B	0V Power Supply	Blue	Blue
D	1. Analogue Positive (+) Moisture	Green	Green
E	1. Analogue Return Line (-) Moisture	yellow	yellow
F	RS485 A	white	white
G	RS485 B	brown	brown
C	(rt) IMP-Bus	grey/pink	grey/pink
J	(com) IMP-Bus	blue/red	blue/red
K	2. Analogue Positive (+)	Pink	Pink
E	2. Analogue Return Line (-)	Grey	Grey
H	Screen (is grounded at the sensor. The plant must be properly grounded!)	transparent	transparent

2.6.1. Analogue Output 0..10V with a Shunt-Resistor

There are PLC's which have no current inputs 0..20mA, but voltage inputs 0..10V. With the help of a shunt resistor with 500 ohm (in the delivery included) it is possible to generate a 0..10V signal from the current signal 0..20mA. The 500 ohm shunt resistor should be placed at the end of the line resp. at the input of the PLC. Following drawing shows the circuit principle.

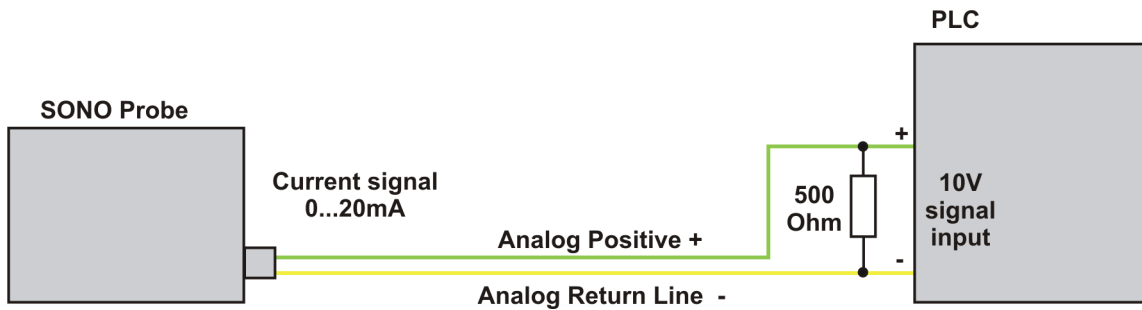

2.7. Connection diagram with SONO-VIEW



SONO-VARIO



SONO-SILO

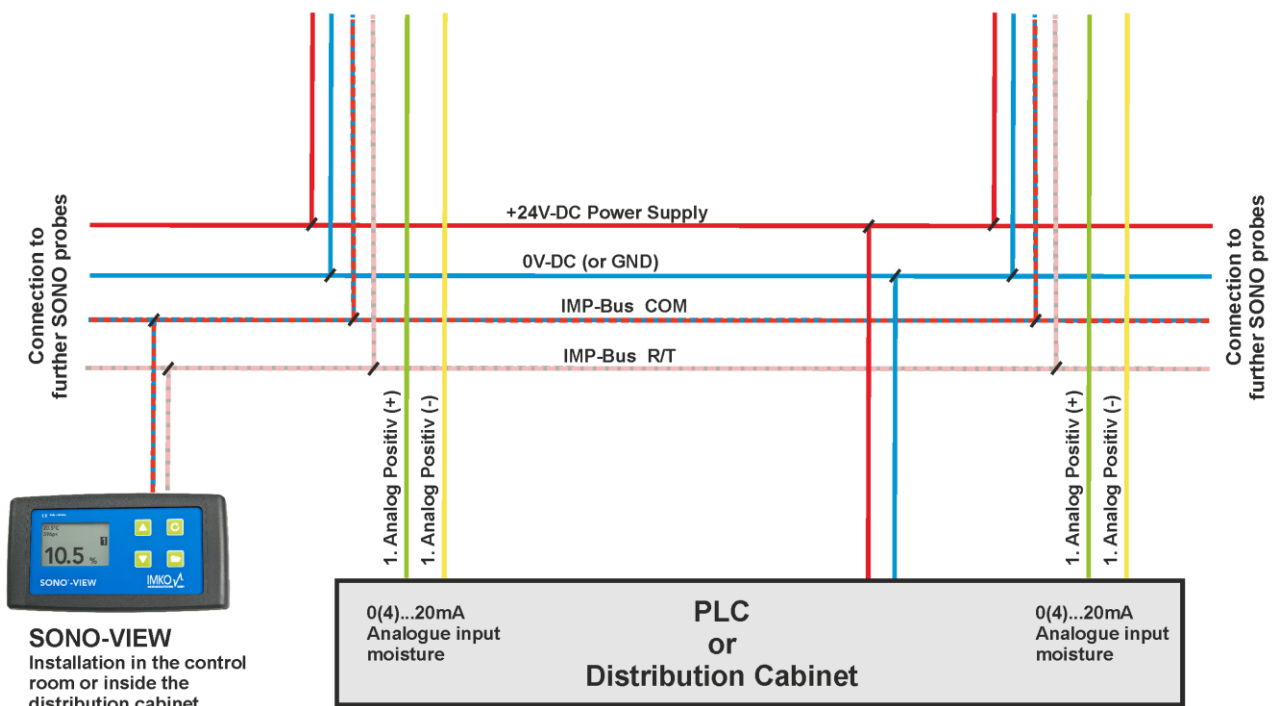

3. Installation of the Probe

The installation conditions are strongly influenced by the constructional circumstances of the installation facility. The ideal installation location must be established individually. The following guidelines should hereby be observed.

3.1. Assembly Instructions

The following instructions should be followed when installing the probe:

- The installation locations may not be situated beneath the inlets for additives.
- In case of an uneven base, the probe must be installed at the highest point of the base. No water may accumulate at the probe head as this could falsify the measurement.
- Areas with strong turbulences are not ideal for the installation. There should be a continuous material flow above the probe head.
- The stirring movement of blades should be conducted without gap above the probe head.
- The probe should not be installed in the direct vicinity of electrical disturbing sources such as motors.
- In case of curved installation surfaces in containers, the centre of the probe head should be flush with the radius of the container wall without disturbing the radial material flow in the container. The probe may not project and come in contact with blades or wipers.

Attention! Risk of Breakage!

The probe head is made of hardened special steel and a very wear-resistant ceramic in order to warrant for a long life-span of the probe. In spite of the robust and wear-resistant construction, the ceramic plate may not be exposed to any blows as ceramic is prone to breakage.

Attention! Risk of Overvoltage!

In case of welding work at the plant, all probes must be completely electrically disconnected.

SONO-probes need a stabilized power supply with 12V-DC to max. 24 V-DC. With unstabilized power supply there is the risk of overvoltage. We strongly suggest not to use unstabilized power supplies.

Attention! Risk of Malfunction!

1. In larger concrete plants it could be possible, that there are different mass potentials for different power lines in use, especially if the PLC is installed in larger distances to the moisture probe. Here it could come to problems that the analogue moisture signal 0(4)..20mA could not be measured correctly in the PLC. With such a problem we recommend to use an isolated powerbox for the SONO probe. Available upon request by IMKO.
2. Take care that there are no other electromagnetic fields nearby the SONO probe. E.g. another moisture probe installed beside or in opposite of the SONO probe could influence the measurement field.

Any damage caused by faulty installation is not covered by the warranty!

Abrasive wear of sensor parts is not covered by the warranty!

3.2. Assembly Dimensions

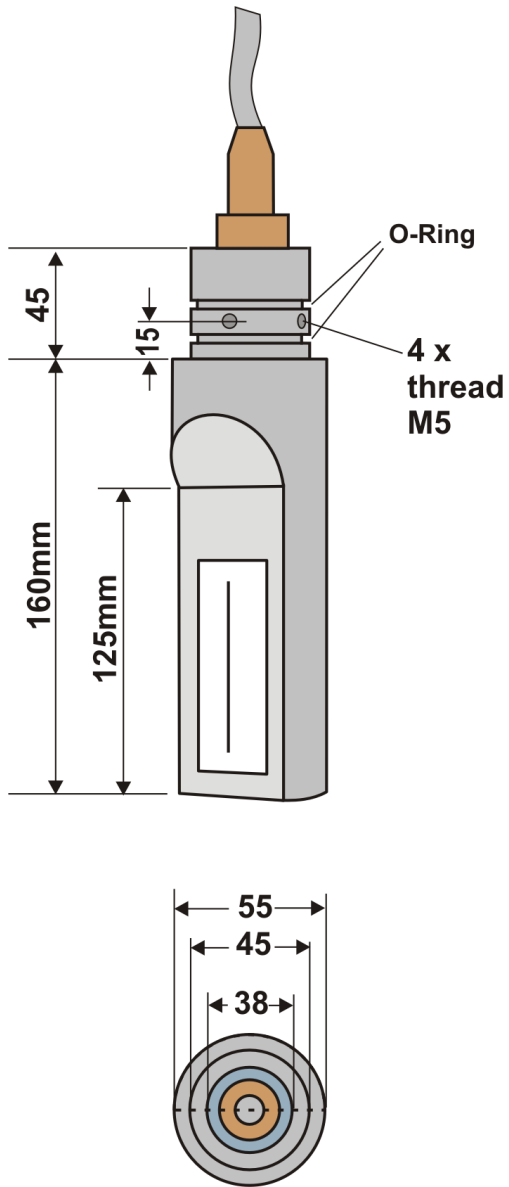

Tube Extension (steel) for SONO-SILOstandard

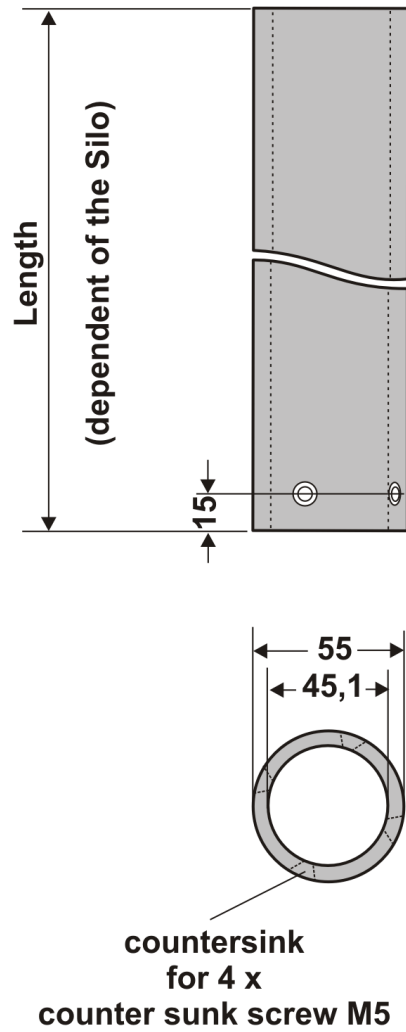

3.3. Mounting of SILO-ES Probe Head

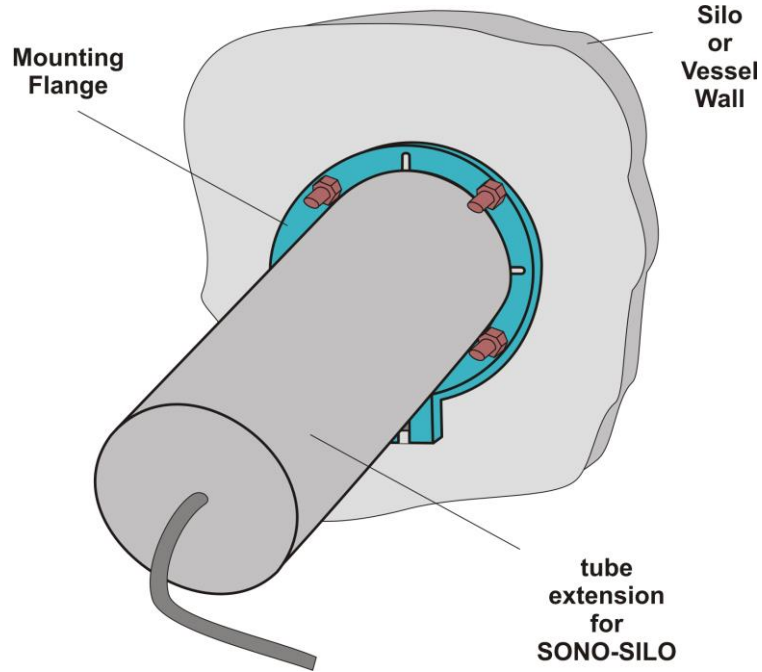

Dimensions of the Mounting Flange

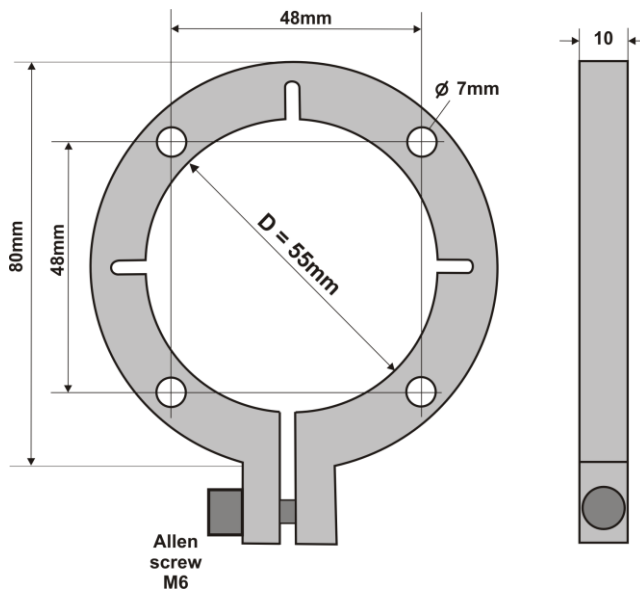

3.4. Mounting on a silo or weighing bin

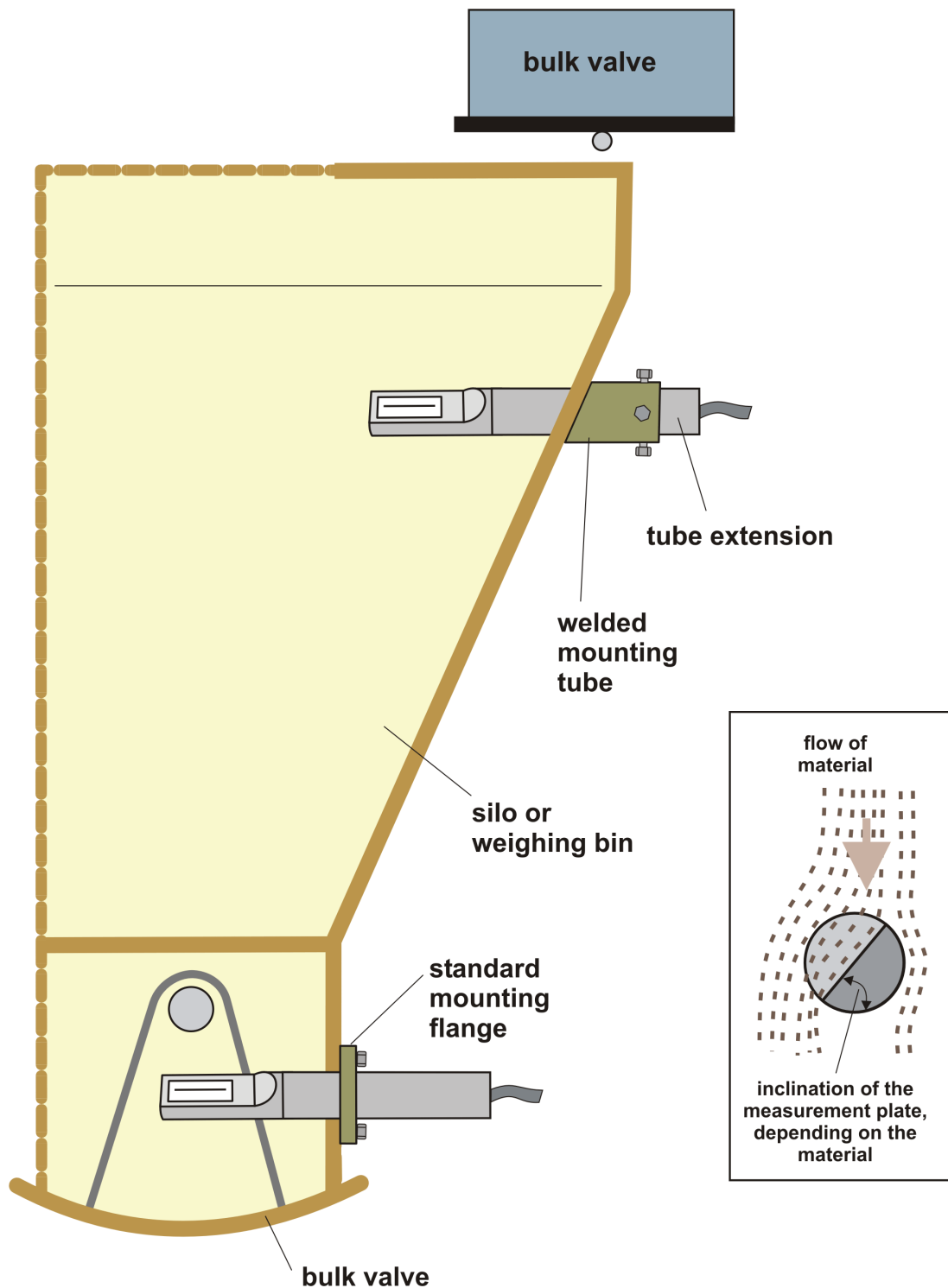

3.5. Gas- and waterproofed Installation in a Tube or Container

For a pressure-tight installation of a SONO probe in a vessel or a tube, a flange installation is recommended. For such applications we recommend to use IMKO's moisture probe **SONO-FLANGE**.

Information upon request.

4. Serial Connection to the SM-USB Module from IMKO

The SM-USB provides the ability to connect a SONO probe either to the standard RS485 interface or to the IMP-Bus from IMKO. **In fact that the IMP-Bus is more robust and enables the download of a new firmware to the SONO probe, the SONO probes are presetted ex-factory to the IMP-Bus. So it is recommended to use the IMP-Bus for a serial communication.** Both connector ports are shown in the drawing below.

The SM-USB is signalling the status of power supply and the transmission signals with 4 LED's. When using a dual-USB connector on the PC, it is possible to use the power supply for the SONO probe directly from the USB port of the PC without the use of the external AC adapter.

Connection to the Probe:

RS485 Connector

Pin B: 0V Power Supply

Pin A: +12VDC Power Supply

Pin G: RS485B Lead Colour "brown"

Pin F: RS485A Lead Colour "white"

+12VDC

IMP-Bus Connector

With the option to accomplish a download of the firmware for the SONO probe

Pin B: 0V Power Supply

Pin A: +12VDC Power Supply

Pin C: (rt) Lead Colour "grey/pink"

Pin J: (com) Lead Colour "blue/red"

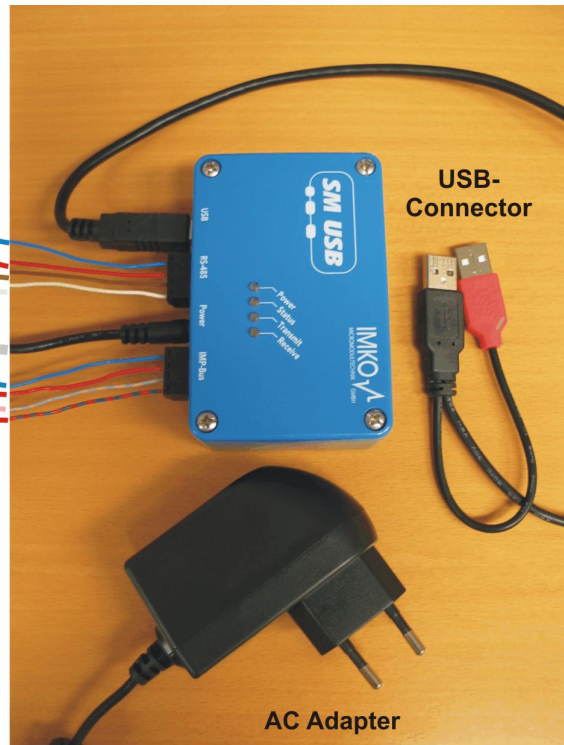

How to start with the SM-USB module from IMKO

- Install USB-Driver from USB-Stick.
- Connect the SM-USB to the USB-Port of the PC and the installation will be accomplished automatically.
- Install Software **SONOConfig-Setup.msi** from USB-Stick.
- Connection of the SONO probe to the SM-USB, with 4 wires for power supply and serial interface.
- Check the setting of the COM-Ports in the Device-Manager und setup the specific COM-Port with the Baudrate of 9600 Baud in SONO-CONFIG with the button "**Bus**" and "**Configuration**" (COM1-COM15 is possible).
- Start "**Scan probes**" in SONO-CONFIG.
- The SONO probe logs in the window „**Probe List**“ after max. 30 seconds with its serial number.

Note 1:

In the Device-Manager passes it as follows:

Control Panel → System → Hardware → Device-Manager

Under the entry “Ports (COM & LPT) now the item “USB Serial Port (COMx)” is found.

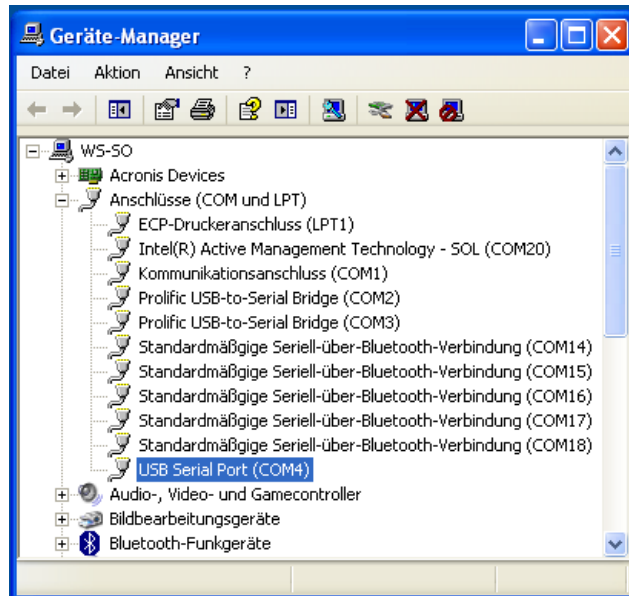

COMx set must be between COM1....COM9 and it should be ensured that there is no double occupancy of the interfaces.

If it comes to conflicts among the serial port or the USB-SM has been found in a higher COM-port, the COM port number can be adjusted manually:

By double clicking on "USB Serial Port" you can go into the properties menu, where you see "connection settings" – with "Advanced" button, the COM port number can be switched to a free number.

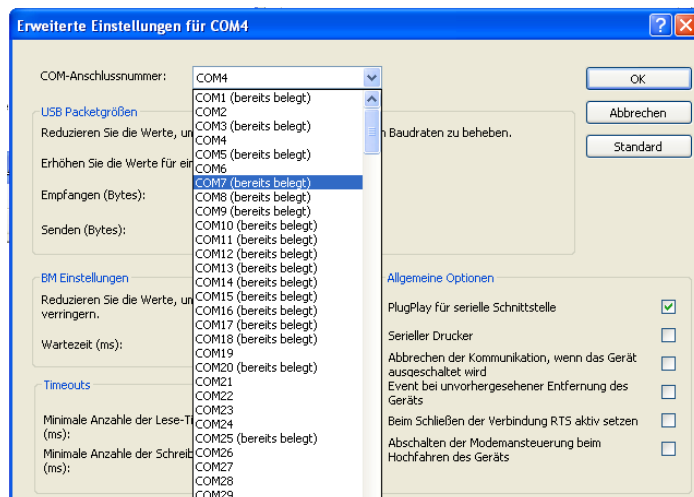
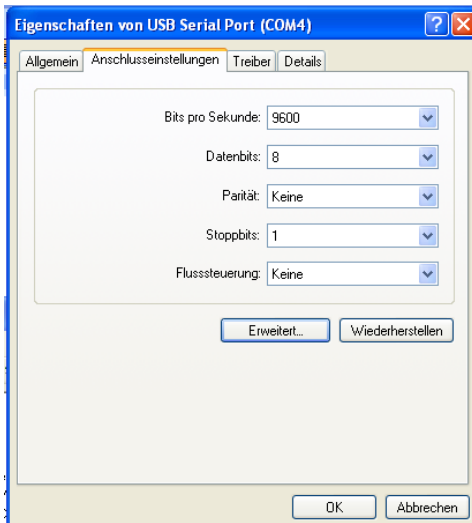

After changing the COMx port settings, SONO-CONFIG must be restarted.

5.1.2. Configuration of serial SONO-interface

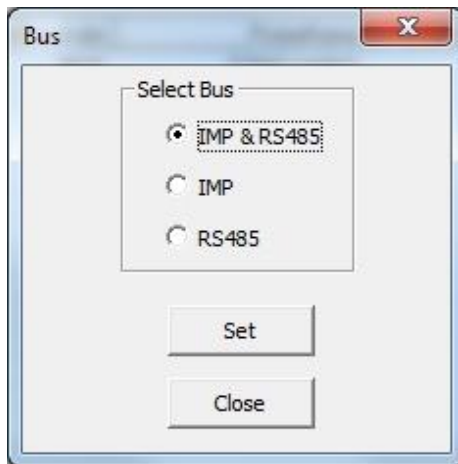

The serial interface inside the SONO probe can be selected to IMP-Bus or RS485. Due to very robust behavior it is recommended to select the IMP-Bus.

5.1.3. Set analogue outputs of the SONO probe

In the menu "Config" and the window "Analog Output" the two analogue outputs of the SONO probe can be configured (see Chapter "Analogue outputs..").

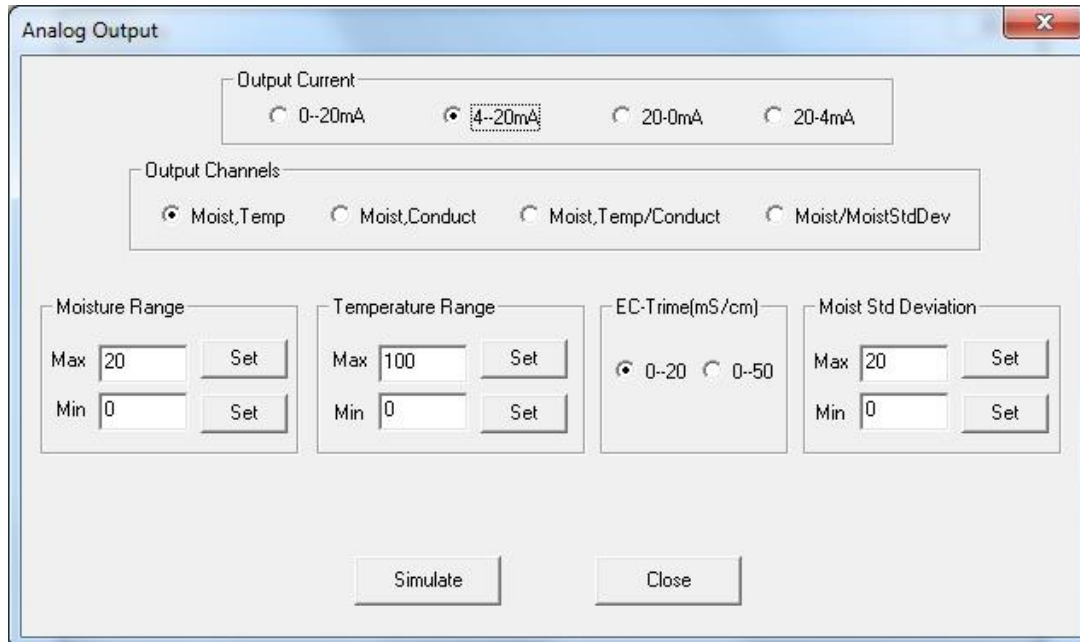

5.1.4. Configuration of Measure Mode

In "Probe List" with "Config" and "Measure Mode & Parameters" the SONO probe can be adjusted to the desired measure mode CA, CF, CS, CK, CC or CH (see Chapter "Configuration Measure Mode

By selecting the operating mode, the SONO probe can be set up to different measurement modes, e.g. for averaging values from several single measurement values, for performing a filtering or performing other functions (see chapter "**Measurement mode configuration**" in this manual).

Furthermore, a SONO probe can be set to a special required precision of the single value measurement with "**Single Precise Parameters**". It is about settings, how the TDR radar pulse is executed and evaluated during one measurement cycle. The next chapter describes how this can be done.

5.1.5. Setting the precision of a single value measurement cycle

The SONO probe can be adjusted to the precision of a single value measurement via "**Single Precise Parameters**". First of all, the more accurate the SONO probe has to measure, the longer the time required for a single value measurement with a TDR radar pulse evaluation. There are applications where the SONO probe under a silo valve has only 2 to 4 seconds to perform several measurements with average value building. Here, a precise single value measurement would take too long, which is why the setting "**Quick**" with a shortest measuring time of 280 ms is recommended. Especially since the fluctuating flow of material under a silo valve cannot lead to constant conditions anyway in order to be able to carry out a highly precise individual measurement.

However, there are applications where it is necessary to achieve measuring accuracies up to $\pm 0.05\%$ moisture content which is only possible with very constant material conditions. E.g. in liquids with fractions of water in oil or in emulsions.

The following table provides an overview of the possible settings in the SONO probe for a single TDR radar pulse evaluation.

Parameter Setting	Measure-Mode	Function of the parameter	Application
Quick:	Mode C e.g. CS, CH, CF, etc.	Very quick TDR pulse search and very quick measurement within 280 ms.	e.g. under a silo flap with only 2-4 seconds measurement time.
Quick Precise:	Mode C e.g. CS, CH, CF, etc.	Quick and precise TDR pulse search and precise measurement within 350ms.	Similar to „Quick“ but with a little longer reaction time in process measurements.
Mode A:	Mode A	Mode A only with measurements via serial interface of the sensor. E.g. for calibrations.	Mode A for mobile moisture probes with hand measurement device HD2 or SONO-DIS.
Precise: PreciseVal: Input value: 1...4	Mode C <u>and</u> Mode A	Most precise single value measurement with precise TDR radar pulse triggering and pulse analysis. The higher the value 1 to 4 the higher the precision but the longer the measurement time.	Only in process environment where a continuously material flow is guaranteed and a very high precision is necessary.
Single MeasNo Default value: 4 Input value max. 10	Mode C <u>and</u> Mode A	Additional averaging of the single value measurement. Please consider: when 10 is entered, one single measurement can take up to one second.	Only in process environment where a continuously material flow is guaranteed and a very high precision is necessary.

5.1.6. Selection of the individual Calibration Curves

In the menu "**Calibration**" and the window "**Material Property Calibration**" the calibration curves CAL1 to Cal15 which are stored in the SONO probe are loaded and displayed on the screen (takes max. 1 minute). With the mouse pointer individual calibration curves can be activated and tested with the SONO-probe by activating the button "**Set Active Calib**". Furthermore, the individual calibration curves CAL1 to Cal15 can be adapted or modified with the calibration coefficients (see Chapter "**Creating a linear calibration curve**").

Cal	Act	CalID-P	CalName in Probe	MatID-P	TemID-P	DenID-P
0		00000	No Calibration	00000	00000	00000
1	A	06035	Universal-Sand-Mix	06035	06000	06000
2		06065	Sand, bulk density 1.6	06065	06000	06000
3		06066	Sand, bulk density 1.7	06066	06000	06000
4		06067	Sand, bulk density 1.8	06067	06000	06000
5		06068	Sand, bulk density 1.9	06068	06000	06000
6		06069	Gravel/Grit	06069	06000	06000
7		06042	Wood Shavings	06042	06000	06000
8		06046	Brown coal granulate	06046	06000	06000
9		06047	SONO-MIX	06047	06000	06000
10		06043	Salz	06043	06000	06000
11		06049	Lightly sand	06049	06000	06000
12		06050	Sewage sludge	06050	06000	06000
13		06064	GW-Linear	06064	06000	06000
14		06058	Air_to_Water	06058	06000	06000
15		06061	1/10tp	06061	06000	06000

The desired and possibly altered calibration curve (Cal1. .15) which is activated after switching on the probes power supply can be adjusted with the button "**Set Default Calib**".

The calibration name can be entered in the window "Calibration Name".

The coefficients m0 to m1 (for linear curves) and m0 to m5 (for non-linear curves) can be entered and adjusted directly by hand with the buttons "**Set**" and "**Save**". Possible are non-linear calibration curves with polynomials up to fifth order (m0-m5).



Attention: Use "dot" as separator not comma, for coefficients m0 to m5 !

Determination of the parameters m0 and m1 for a linear calibration curve (see also chapter "Creating a linear calibration curve...")

1. Download the Excel-Sheet „SONO_LinearCalibration_Calculation“ from IMKO’s Homepage in the dropdown menu „Support Software“.
2. Enter into the Excel-Sheet both TP-values with the respective reference moisture values.
3. Read out both parameters m0 and m1 from the Excel-Sheet.
4. Enter, set and save both parameters m0 and m1 in the selected calibration curve.

5.1.7. Test run in the respective Measurement Mode

In the menu "Test" and the window "Test in Mode CA to CF" the measured moisture values "MoistAve" (Average) of the SONO probe are displayed on the screen and can be parallel saved in a file. In the menu "Test" and the window "Test in Mode CS" the measured single measurement values "Moist" (5 values per second) of the SONO probe are displayed on the screen and parallel stored in a file. In „Test in Mode A“ single measurement values (without average) are displayed on the screen and can also be stored in a file.



Attention: for a test run in mode CA, CH, CC, CF, CS or A it must be ensured that the SOI probe was also set to this mode (Measure Mode CA, CF, CS, A). If this is not assured, the probe returns zero values.

No.	Time	Date	MoistAve	MatTemp	EC-Trime	TDRave	DeltaCnt	tpAve	Moist1	Moist2	Moist3	Moist4	TDR1	TDR2	TDR3	TDR4
1	10:34:41	25-06-2015	5.00	23.70	0.18	84.52	2	193.46	4.94	4.99	-1.00	-1.00	84.5	84.5	-1.0	84.5
2	10:34:40	25-06-2015	4.99	23.70	0.18	84.52	3	193.30	5.09	5.09	4.89	-1.00	84.5	84.5	84.6	84.5
3	10:34:39	25-06-2015	4.98	23.70	0.17	84.56	3	193.20	4.95	4.94	4.94	-1.00	84.6	84.5	84.5	84.5
4	10:34:38	25-06-2015	5.01	23.70	0.15	84.60	2	193.63	4.98	5.11	-1.00	-1.00	84.6	84.6	-1.0	84.5
5	10:34:37	25-06-2015	5.00	23.70	0.16	84.58	3	193.49	5.14	4.96	4.87	-1.00	84.6	84.6	84.6	84.5
6	10:34:36	25-06-2015	4.97	23.70	0.16	84.58	3	192.95	4.89	4.96	5.09	-1.00	84.6	84.6	84.5	84.5
7	10:34:35	25-06-2015	4.92	23.70	0.17	84.54	2	192.17	4.89	5.02	-1.00	-1.00	84.6	84.6	-1.0	84.5
8	10:34:34	25-06-2015	4.94	23.70	0.18	84.52	3	192.47	4.94	4.96	4.81	-1.00	84.5	84.5	84.5	84.5
9	10:34:33	25-06-2015	4.97	23.70	0.17	84.56	3	193.00	4.97	4.95	5.05	-1.00	84.6	84.6	84.5	84.5
10	10:34:32	25-06-2015	4.97	23.70	0.17	84.54	2	192.93	4.95	4.96	-1.00	-1.00	84.5	84.6	-1.0	84.5
11	10:34:31	25-06-2015	4.96	23.70	0.18	84.52	3	192.66	5.07	4.80	5.08	-1.00	84.5	84.6	84.5	84.5
12	10:34:30	25-06-2015	4.89	23.70	0.17	84.56	3	191.60	4.87	4.84	4.99	-1.00	84.6	84.5	84.5	84.5
13	10:34:29	25-06-2015	4.91	23.70	0.17	84.56	2	191.99	4.87	4.89	-1.00	-1.00	84.6	84.6	-1.0	84.5
14	10:34:28	25-06-2015	4.93	23.70	0.18	84.52	3	192.20	4.92	4.85	5.04	-1.00	84.5	84.5	84.6	84.5
15	10:34:27	25-06-2015	4.90	23.70	0.17	84.54	3	191.84	4.96	4.99	4.84	-1.00	84.6	84.5	84.5	84.5
16	10:34:26	25-06-2015	4.91	23.70	0.17	84.54	2	192.05	4.85	4.89	-1.00	-1.00	84.5	84.6	-1.0	84.5
17	10:34:25	25-06-2015	4.93	23.70	0.17	84.54	3	192.30	4.93	4.94	4.98	-1.00	84.5	84.5	84.6	84.5
18	10:34:24	25-06-2015	4.88	23.70	0.17	84.56	3	191.39	4.98	4.96	4.85	-1.00	84.5	84.6	84.5	84.5
19	10:34:23	25-06-2015	4.84	23.70	0.16	84.58	2	190.86	4.73	4.87	-1.00	-1.00	84.6	84.6	-1.0	84.5
20	10:34:22	25-06-2015	4.88	23.70	0.17	84.54	9	191.46	4.87	4.83	4.82	4.95	84.6	84.5	84.6	84.5

Following measurement values are displayed on the screen:

- MoistAve** Moisture Value in % (Average)
- MatTemp** Temperature
- EC-TRIME** Radar-based-Conductivity EC-TRIME in dS/m (or mS/cm)
- TDRave** TDR-Signal-Level for special applications.
- DeltaCount** Number of single measurements which are used for the averaging.
- tpAve** Radar time (average) which corresponds to the respective moisture value.

By clicking „Save“ the recorded data is saved in a text file in the following path:

`\SONO-CONFIG.exe-PfadMD\Dateiname`

The name of the text file **Statis+SN+yyyymmddHHMMSS.sts** is assigned automatically with the serial number of the probe (SN) and date and time. The data in the text file can be evaluated with Windows-EXCEL.

5.1.8. “Measure” Run in Datalogging-Operation

In the menu "Datalogging" it is possible to acquire and store measurement data from several SONO probes with variable and longer cycle rates in a datalogger-operation, e.g. to store measurement data during a long-term drying cycle.

5.1.9. Basic Balancing in Air and Water

SONO probe heads are identical and manufactured precisely. After an exchange of a probe head it is nevertheless advisable to verify the calibration and to check the basic calibration and if necessary to correct it with a "Basic Balancing".

With a "Basic Balancing" two reference calibration measurements are to be carried out with known set-points ("RefValues"). For the reference media, different calibration materials are used, dependent on the SONO probe type. For SONO probes with a ceramic measurement window, air and water (tap water) is used. For other SONO probes like SONO-GS1 glass beads are used for basic calibrations (on request).



Attention: Before performing a "Basic Balancing" it must be ensured that the SONO probe was set to "Measure Mode" A. If this is not assured, the probe returns zero values. After a "Basic Balancing" the SONO probe has to be set to "Measure Mode C" again, because otherwise the probe would not measure continuously!

In the menu "**Calibration**" and the window "**Basic Balancing**" the two set-point values of the radar time **tp** are displayed with 60ps and 1000ps.

1. Reference set-point A: **tp**=60ps in air (the surface of the probe head must be dry!!)
The first set-point can be activated with the mouse pointer by clicking to No.1. By activating the button "**Do Measurement**" the SONO probe determines the first reference set-point in air. In the column „MeasValues“ the measured raw value of the radar time **t** is displayed (e.g. 1532.05 picoseconds).
2. Reference set-point B: **tp**=1000ps in water. The SONO probe head has to be covered with water in a height of about 50mm. The second set-point can be activated with the mouse pointer by clicking to No.2. By activating the button "**Do Measurement**" the SONO probe determines the second reference set-point in water. In the column „MeasValues“ the measured raw value of the radar time **t** is displayed.
3. By activating the button „**Calculate Coeffs**“ and „**Coeffs → Probe**“ the alignment data is calculated automatically and is stored in the SONO probe non-volatile. With a "Test run" (in Mode A) the radar time **tp** of the SONO probe should be now 60ps in air and 1000ps in water.

No	RefValues(tp)/ps	MoistValues(%)	MeasValues(t)/ps	Comments
1	60.0	0.0		air
2	1000.0	100.0		water

Coefficients	<Calculated>	<in File>	<in Probe>
b0			-1889.74
b1			1.24275

air and water

Do Measurement

Calculate Coeffs

Coeffs -> Probe

Close

5.1.10. Offsetting the material temperature sensor

Material Temp Offset

Temp = Coeff1xMeasured Temp+Coeff0

	Coeff1	Coeff0
Now	1	0
New	1	-5

Set

Close

In the menu „**Calibration**“ and the window „**Material Temp Offset**“, a zero point offset can be adjusted for the material temperature sensor which is installed inside the SONO probe. In this example a temperature deviation of +5° C is produced by inside self-warming of the SONO probe. The correction value -5 can be set in the Coeff0 window.

Material Temp Offset

Temp = Coeff1xMeasured Temp+Coeff0

	Coeff1	Coeff0
Now	1	0
New	1.8	32

Set

Close

The example shows the parameters for displaying the temperature in the unit: Degree Fahrenheit.

5.1.11. Compensation of the electronic temperature

Temperature Compensation

Now TempComp

0.2

New TempComp

0

Set TempComp

Close

With this method of temperature compensation, a possible temperature drift of the SONO-electronic can be compensated. Because the SONO-electronic shows a generally low temperature drift, SONO probes are preset at delivery for standard ambient conditions with the parameter **TempComp=0.2**. Dependent on SONO probe type, this parameter TempComp can be adjusted for higher temperature ranges (up to 120°C for special high temperature version) to values up to **TempComp=0.75**. But it is to consider that it is necessary to make a Basic-Balancing of the SONO probe in air and water, if the parameter TempComp is changed to another value as TempComp=0.2. The parameter TempComp can be changed with the software tool SONO-CONFIG, in the menu "**Calibration**" and the window "**Electronic-Temperature-Compensation**".



Attention: When changing the TempComp parameter, a new basic balancing of the SONO probe is necessary!

6. Technical Data SONO-ES SILO

SENSOR DESIGN

SONO-ES Measurement Transformer: Aluminium case.

SILO-HT Probe Head: The probe head surface consists of stainless steel with highly abrasion-resistant ceramic.

AMBIENT CONDITIONS

SILO-HT Probe Head: -20°C+120°C

SONO-ES Measurement Transformer: -20°C.....+70°C

MOUNTING

Sensor Dimensions:

SILO-ES Probe Head: 55 x 200mm (Diameter x Length)

The mounting flange can be screwed on to the rear side of any container, hopper or silo.

MEASUREMENT RANGE MOISTURE

The sensor measures from 0% up to the point of material saturation. Measurement ranges up to 90% moisture are possible with a special calibration.

MEASUREMENT DATA-PREPROCESSING

MEASUREMENT MODE CA: (Cyclic-Average) For relative short measuring processes with continual average value, filtering and an accuracy of up to 0.1%

MEASUREMENT MODE CF: (Cyclic-Float-Average) For very slow measuring processes with floating average value, filtering and an accuracy of up to 0.1%

MEASUREMENT MODE CS: (Cyclic-Successive) For very short measuring processes without floating average and without filtering with internal up to 100 measurements per second and a cycle time of 200 milliseconds at the analogue output.

Mode CC: (Cyclic Cumulated) with automatic summation of a moisture quantity during one batch process.

Mode CH: (Cyclic Hold) with filtering functions, similar to Mode CC but without summation.

Mode CK: (Cyclic-Kalman-Filter with Boost) Standard setting for SONO-MIX for use in fresh concrete mixer with continual average value with special dynamic Kalman filtering and an accuracy of up to 0.1%.

ANALOGUE OUTPUT

2 x Analogue Outputs 0(4)...20mA

Analogue Output 1: Moisture in % (e.g. 0..20% variably adjustable)

Analogue Output 2: Conductivity (EC-TRIME) 0..20dS/m, or optionally the temperature, or optionally the standard deviation.

In addition, there is the option to split the analogue output 2 into two ranges: into 4..11mA for the temperature and 12..20mA for the conductivity. The analogue output 2 hereby changes over into an adjustable 5 second cycle between these two (current) measurement windows.

The two analogue outputs can be variably aligned with the SONO-CONFIG software. For a 0-10V DC voltage output, a 500R resistor can be installed.

CALIBRATION

The sensor is provided with a universal calibration for sand. A maximum of 15 different calibrations can be stored. For special materials, variable calibrations with polynomials up to the 5th order are possible. A zero point correction can be performed easily with the SONO-CONFIG software.

COMMUNICATION

A RS485 interface enables network operation of the probe, whereby a data bus protocol for the connection of several SONO probes to the RS485 is implemented by default. The connection of the probe to industrial busses such as Profibus, Ethernet, etc. is possible via optional external modules (available upon request).

POWER SUPPLY

+7V to +24V DC, 3 W max.

Attention: Do not use unstabilized power supplies. Risk of overvoltage !

MEASUREMENT FIELD EXPANSION

Approximately 50 - 80 mm, depending on material and moisture.

CONNECTOR PLUG

The sensor is equipped with a robust 10-pole MIL flange connector. Ready made connection cables with MIL connectors are available cable lengths of 4m, 10m, or 25 m.

7. Safety Notes

In this documentation, text points are highlighted, which require special attention.



DANGER:

The Warning Triangle with the exclamation mark warns you against personal injury or property damage.

Intended Use

Sensors and measuring systems of IMKO GmbH may only be used for the purpose described, taking into account the technical data. Misuse **and use of the** equipment other than for its intended purpose **are not eligible**. The function and operational safety of a sensor or measuring system can only be guaranteed if the general safety precautions, national regulations and the special safety instructions in this operating manual are observed during use.

The moisture sensors and measuring systems of IMKO GmbH are used to measure moisture according to the measuring purpose and measuring range defined and defined in the technical data. Only adherence to the instructions described in the manual is regarded as intended use. The manual describes the connection, use and maintenance of IMKO sensors and IMKO measuring systems. Read the manual before connecting and operating a sensor or measuring system. The manual is part of the product and must be kept close to the sensor or measuring system.



Impairment of safety

The sensor or the measuring system has been designed and tested in accordance with EN 61010 safety regulations for electronic measuring instruments and has left the factory in a safe and safe condition. If the sensor or the measuring system can no longer be operated safely, it must be put out of operation and secured by means of marking before further commissioning. In case of doubt, the sensor or the measuring system must be sent to the manufacturer or his contractual partner for repair or maintenance.



Modifications

For safety reasons, it is not permitted to carry out any modifications or modifications to the sensor or the measuring system without the consent of the manufacturer. The opening of the sensor or hand-held meter, adjustment and repair work, as well as all maintenance work other than the work described in the manual may only be carried out by a specialist authorized by IMKO. The sensor or the measuring system must be disconnected from the power supply before installation or maintenance work. Do not open or repair the hand-held unit and the power supply!



Hazard Warnings

Danger due to improper operation. The sensor or the measuring system may only be operated by instructed personnel. The operating personnel must have read and understood the operating instructions.

**Danger by electricity**

The hand-held meter must not be immersed in water or other liquids. The sensor is insensitive to moisture contained in the typically measured products. Only connect the hand-held meter to a properly installed outlet with the supplied voltage supply cable, the voltage of which corresponds to the technical data. Make sure that the power outlet is well accessible, so that you can unplug the power supply quickly if necessary. Use only the adapter that is suitable for your outlet.

Only operate the meter with the supplied original accessories. If you need additional accessories or replacement, please contact the manufacturer.

Do not use the meter in following case:

- if the measuring instrument, sensor, plug-in power supply or accessories are damaged,
- the sensor or the measuring system does not operate as intended,
- the power cord or plug is damaged,
- the sensor or the measuring system has fallen down.

Unplug the power supply from the wall outlet in following case:

- if you do not use the sensor or the measuring system for an extended period of time,
- before cleaning, unpacking or changing the sensor or the measuring system,
- if you are working inside the sensor or measuring instrument, e.g. connect devices,
- if a fault occurs during operation,
- during thunderstorms.

**Caution - Property damage**

Ensure that there is a sufficient distance to strong heat sources such as heating plates, heating pipes. Disconnect the sensor or handheld device from other devices before relocating or transporting it. Disconnect the connectors on the device.

Do not use aggressive chemical cleaning agents, scouring agents, hard sponges or the like.