

DIN W48×H48mm Compact Counter/Timer

■ Features

- Counting speed: 1cps/30cps/2kcps/5kcps
- Selectable voltage input (PNP) or no-voltage input (NPN)
- Input mode: Up, Down, Up/Down
- Dot for Decimal Point / Hour. Min. Second by RESET key
- Wide range of input power supply
: 100-240VAC 50/60Hz, 24VAC 50/60Hz, 24-48VDC universal
- Selectable Counter/Timer by internal DIP switch
- [Counter]
20 input modes/18 output modes
- [Timer]
16 output modes
- Various time setting range - 5-digit model: 0.01 sec to 9999.9 hour /
4-digit model: 0.01 sec to 9999 hour
- Output: Indicator, 1-stage setting



⚠ Please read "Safety Considerations" in operation manual before using.



■ Model

Model	Display digit	Size	Output	Power supply
FX4S-1P2	9999 (4-digit)	DIN W48×H48mm	1-stage setting	24VAC 50/60Hz, 24-48VDC
FX4S-1P4				100-240VAC 50/60Hz
FX5S-I2	99999 (5-digit)		Indicator	24VAC 50/60Hz, 24-48VDC
FX5S-I4				100-240VAC 50/60Hz

■ Specifications

Model	1-stage setting	FX4S-1P2	FX4S-1P4	—	—
	Indicator	—	—	FX5S-I2	FX5S-I4
Display digit		4-digit		5-digit	
Character size (W×H)		3.8×7.6mm		4×8mm	
Power supply		24VAC~ 50/60Hz, 24-48VDC=	100-240VAC~ 50/60Hz	24VAC~ 50/60Hz, 24-48VDC=	100-240VAC~ 50/60Hz
Permissible voltage range		90 to 110% of rated voltage			
Power consumption		AC: Max. 3.5VA DC: Max. 2.3W	Max. 4.6VA	AC: Max. 3VA DC: Max. 1.8W	Max. 3.8VA
Max. counting speed of CP1/CP2		Selectable 1cps/30cps/2kcps/5kcps (DIP switch)			
Return time		Max. 500ms			
Min. signal width		INHIBIT, RESET input: approx. 20ms			
Input method		Selectable voltage input (PNP) method or no-voltage input (NPN) method [Voltage input (PNP) method]-input impedance: max. 10.8kΩ, [H]: 5-30VDC=, [L]: 0-2VDC [No-voltage input (NPN) method]-short-circuit impedance: max. 470Ω, short-circuit residual voltage: max. 1VDC, open-circuit impedance: min. 100kΩ			
One-shot output time		0.05 to 5 sec			
Control output	Contact	Type	Instantaneous SPDT (1c)	—	
		Capacity	250VAC~ 3A, 30VDC= 3A resistive load	—	
Relay	Solid state	Type	NPN open collector: 1	—	
		Capacity	Max. 30VDC=, 100mA	—	
Relay life cycle	Mechanical	Min. 5,000,000 operations			
	Electrical	Min. 100,000 operations (250VAC 3A resistive load)			
Repeat/Set/Voltage/Temperature error		Max. ±0.01% ±0.05 sec			
Insulation resistance		Over 100MΩ (at 500VDC megger)			
External power supply		Max. 12VDC= ±10% 50mA			
Memory retention		Approx. 10 years (non-volatile memory)			
Dielectric strength		2,000VAC 50/60Hz for 1 minute (between all terminals and case)			
Noise immunity	AC voltage	±2kV the square wave noise (pulse width 1μs) by the noise simulator			
	AC/DC voltage	±500V the square wave noise (pulse width 1μs) by the noise simulator			
Vibration	Mechanical	0.75mm amplitude at frequency 10 to 55Hz (for 1 min) in each X, Y, Z direction for 1hour			
	Malfunction	0.5mm amplitude at frequency 10 to 55Hz (for 1 min) in each X, Y, Z direction for 10min			
Shock	Mechanical	300m/s ² (approx. 30G) in each X, Y, Z direction for 3 times			
	Malfunction	100m/s ² (approx. 10G) in each X, Y, Z direction for 3 times			
Environment	Ambient temperature	-10 to 55°C, storage: -25 to 65°C			
	Ambient humidity	35 to 85%RH, storage: 35 to 85%RH			
Protection structure		IP20 (front part, IEC standard)			
Approval		CE c UL US			
Weight ^{※1}		Approx. 171g (approx. 110g)		Approx. 156g (approx. 95g)	

※1: The weight includes packaging. The weight in parenthesis is for unit only. ※Environment resistance is rated at no freezing or condensation.

Up/Down Counter/Timer

Connections

● FX4S-1P□

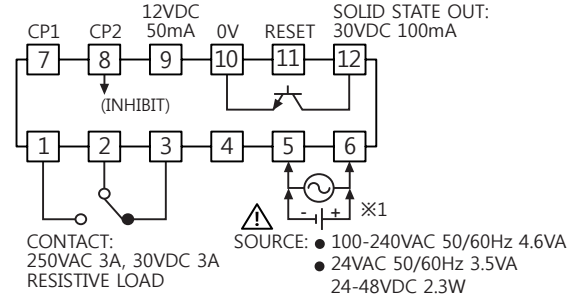

● FX5S-□

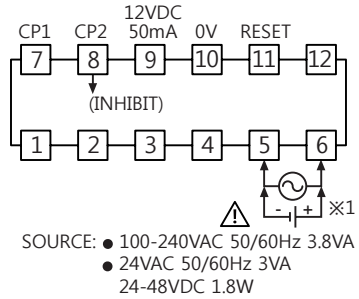

※1: AC voltage: 100-240VAC 50/60Hz 4.6VA/3.8VA

AC/DC voltage: 24VAC 50/60Hz 3.5VA/3VA, 24-48VDC 2.3W/1.8W

※INHIBIT: In case of timer mode, this terminal is for time hold.

(voltage input (PNP): connect with 12VDC, no-voltage input (NPN): connect with 0VDC)

Dimensions

(unit: mm)

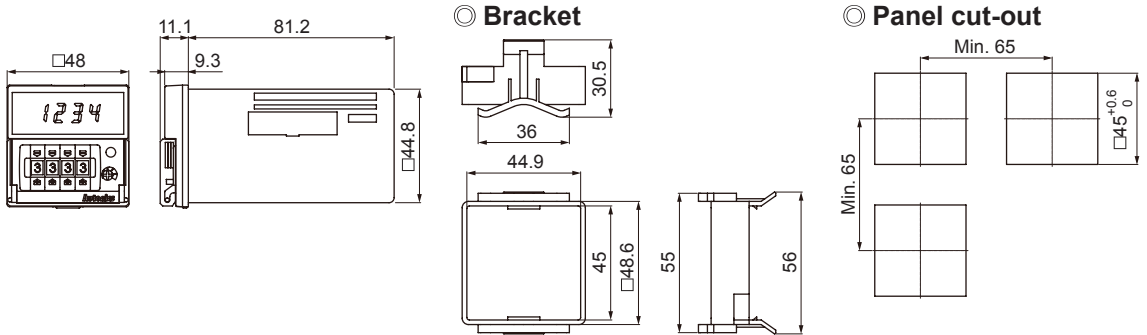

Input Connection

◎ Voltage input (PNP)

● Solid state input (standard sensor: PNP output type sensor)

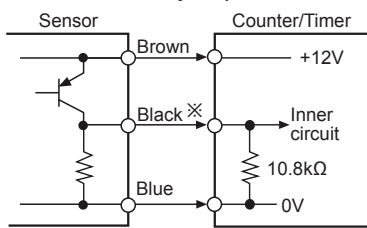

(PNP output)

※CP1, CP2 (INHIBIT), RESET input part

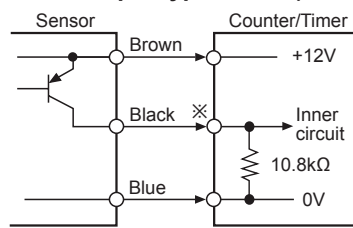

(PNP open collector output)

● Contact input

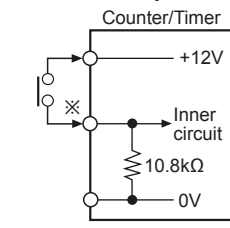

※Counting speed: Set as 1 or 30cps

◎ No-voltage input (NPN)

● Solid state input (standard sensor: NPN output type sensor)

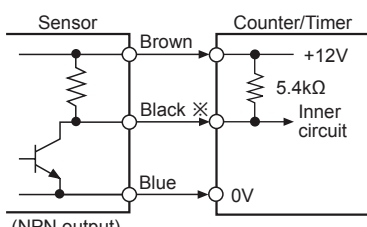

(NPN output)

※CP1, CP2 (INHIBIT), RESET input part

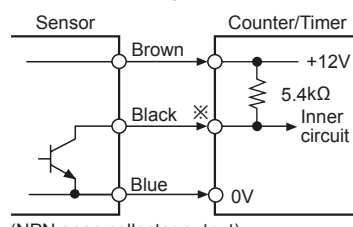

(NPN open collector output)

● Contact input

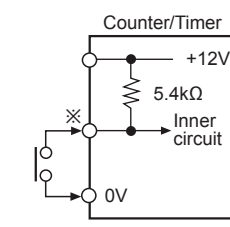

※Counting speed: Set as 1 or 30cps

■ DIP Switch Setting

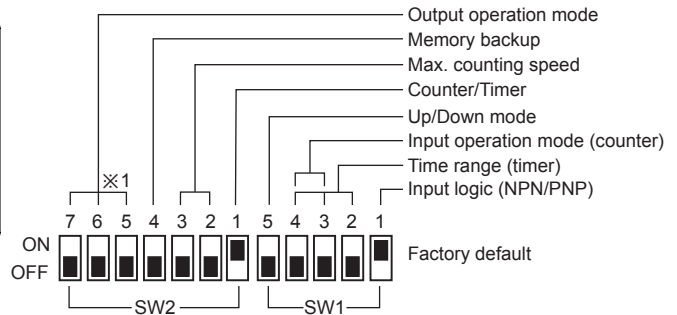
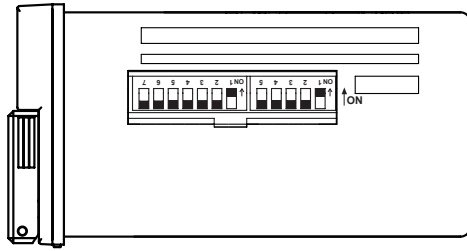

※1: Indicator model (FXS5-I□) does not have no. 5, 6, 7 of SW2. for output operation mode setting.

● Input logic (CP1, CP2, INHIBIT, RESET input)

SW1	Function
1 ON <input type="checkbox"/> OFF <input type="checkbox"/>	NPN (No-voltage input)
ON <input type="checkbox"/> OFF <input type="checkbox"/>	PNP (voltage input)

● Up/Down mode

SW1	Function
5 ON <input type="checkbox"/> OFF <input type="checkbox"/>	Down mode
ON <input type="checkbox"/> OFF <input type="checkbox"/>	Up mode

● Counter/Timer

SW2	Function
1 ON <input type="checkbox"/> OFF <input type="checkbox"/>	Counter mode
ON <input type="checkbox"/> OFF <input type="checkbox"/>	Timer mode

● Memory backup

SW2	Function
4 ON <input type="checkbox"/> OFF <input type="checkbox"/>	No memory backup
ON <input type="checkbox"/> OFF <input type="checkbox"/>	Memory backup

● Max. counting speed

SW2	3 2	3 2	3 2	3 2
ON <input type="checkbox"/> OFF <input type="checkbox"/>	ON <input type="checkbox"/> OFF <input type="checkbox"/>	ON <input type="checkbox"/> OFF <input type="checkbox"/>	ON <input type="checkbox"/> OFF <input type="checkbox"/>	ON <input type="checkbox"/> OFF <input type="checkbox"/>
Function	1cps	30cps	2kcps	5kcps

● Time range (timer)

SW1	FX4S-1P□	FX5S-I□
4 3 2 ON <input type="checkbox"/> OFF <input type="checkbox"/>	99.99sec	9999.9sec
4 3 2 ON <input type="checkbox"/> OFF <input type="checkbox"/>	999.9sec	99999sec
4 3 2 ON <input type="checkbox"/> OFF <input type="checkbox"/>	9999sec	9min 59.99sec
4 3 2 ON <input type="checkbox"/> OFF <input type="checkbox"/>	99min 59sec	99min 59.9sec
4 3 2 ON <input type="checkbox"/> OFF <input type="checkbox"/>	999.9min	9999.9min
4 3 2 ON <input type="checkbox"/> OFF <input type="checkbox"/>	99hour 59min	9hour 59min 59sec
4 3 2 ON <input type="checkbox"/> OFF <input type="checkbox"/>	999.9hour	999hour 59min
4 3 2 ON <input type="checkbox"/> OFF <input type="checkbox"/>	9999hour	9999.9hour

■ Error Display and Output Operation

Error Display	Error description	Troubleshooting
ErrD	Setting value is 0.	Change the setting value anything but 0.

※When error occurs, the output turns OFF.

※Indicator model does not have error display function.

Up/Down Counter/Timer

■ Dot for Decimal Point / Hour. Min. Second

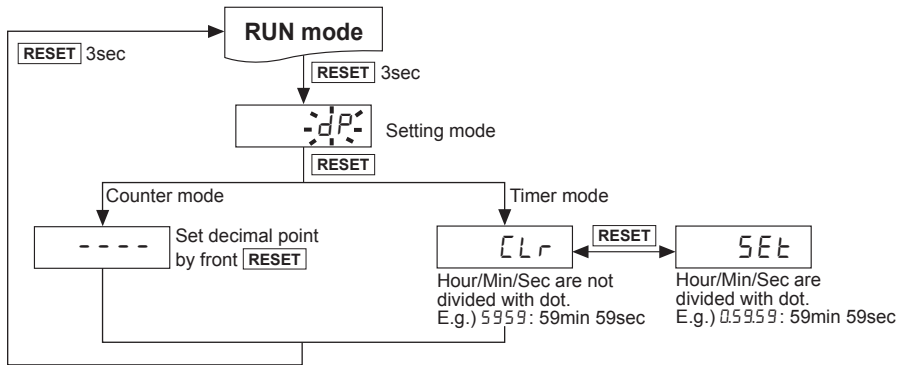

※Run mode: hold the **RESET** key for over 3 sec, and it enters setting mode [dP].

※Setting mode: hold the **RESET** key for over 3 sec, and it saves the setting and returns to RUN mode.

If there is no **RESET** key input for 60 sec when entering setting mode, it returns to RUN mode.

● Changing the decimal point

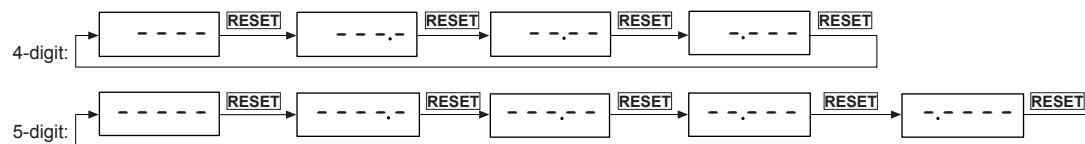

※It returns to RUN mode if no **RESET** key or digital switch is applied for 60 sec in decimal point setting status.

■ Counting & Time Operation for Indicator (FX5S-I□)

◎ Counting operation

● Input mode: Up

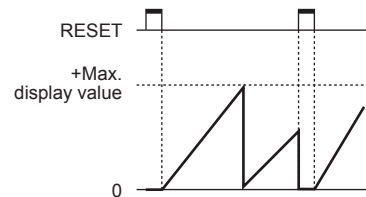

● Input mode: Down

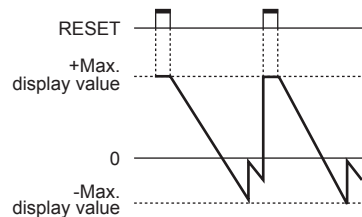

● Input mode: Up/Down-A, B, C

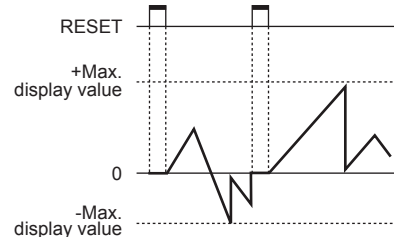

● Input mode: Up/Down-D, E, F

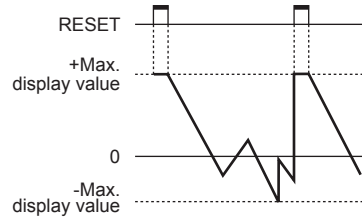

◎ Time operation

● Up mode

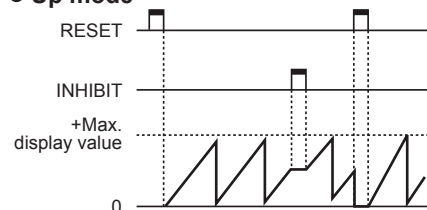

● Down mode

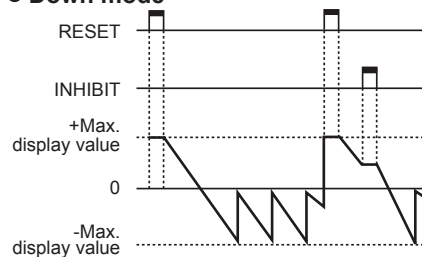

Input Operation Mode (counter)

※CP: Clock Pulse

Input mode		SW1	Voltage input (PNP) method	No-voltage input (NPN) method
Up mode ON <input type="checkbox"/> 5 OFF <input checked="" type="checkbox"/>	Up/Down-A (command input)	ON <input type="checkbox"/> 4 3 OFF <input checked="" type="checkbox"/>		
	Up/Down-B (individual input)	ON <input type="checkbox"/> 4 3 OFF <input checked="" type="checkbox"/>		
	Up/Down-C (phase difference input)	ON <input type="checkbox"/> 4 3 OFF <input checked="" type="checkbox"/>		
	Up (adding input)	ON <input checked="" type="checkbox"/> 4 3 OFF <input type="checkbox"/>		
Down mode ON <input checked="" type="checkbox"/> 5 OFF <input type="checkbox"/>	Up/Down-D (command input)	ON <input type="checkbox"/> 4 3 OFF <input checked="" type="checkbox"/>		
	Up/Down-E (individual input)	ON <input type="checkbox"/> 4 3 OFF <input checked="" type="checkbox"/>		
	Up/Down-F (phase difference input)	ON <input type="checkbox"/> 4 3 OFF <input checked="" type="checkbox"/>		
	Down (subtracting input)	ON <input checked="" type="checkbox"/> 4 3 OFF <input type="checkbox"/>		

※A: over min. signal width, B: over than 1/2 of min. input signal width. If the signal is smaller than these width, it may cause counting error (±1).

Up/Down Counter/Timer

Output Operation Mode

■ ← One-shot output (0.05 to 5sec)

□ ← Self-holding (hold) output

Output mode (SW2)	Up mode		Down mode		Operation
	ON	OFF	ON	OFF	
F	Up, Up/Down-A, B, C		Down, Up/Down-D, E, F		After count-up, counting display value increases or decreases until reset signal input is applied and self-holding output is maintained.
7 6 5 ON OFF					
N	Up, Up/Down-A, B, C		Down, Up/Down-D, E, F		After count-up, counting display value and self-holding output are maintained until reset signal input is applied.
7 6 5 ON OFF					
C	Up, Up/Down-A, B, C		Down, Up/Down-D, E, F		When count-up, counting display value is reset and it counts simultaneously.
7 6 5 ON OFF					
R	Up, Up/Down-A, B, C		Down, Up/Down-D, E, F		After count-up, counting display value is reset after one-shot output time and it counts simultaneously.
7 6 5 ON OFF					
K	Up, Up/Down-A, B, C		Down, Up/Down-D, E, F		After count-up, counting display value increases or decreases until reset signal input is applied.
7 6 5 ON OFF					
P	Up, Up/Down-A, B, C		Down, Up/Down-D, E, F		After count-up, counting display value is maintained while output is ON. Counting value is internally reset and it counts simultaneously.
7 6 5 ON OFF					
Q	Up, Up/Down-A, B, C		Down, Up/Down-D, E, F		After count-up, counting display value increases or decreases during one-shot output time.
7 6 5 ON OFF					
S	Up		Down		Up, Up/Down-A, B, C input mode : Output maintains ON when counting display value is larger or equal than setting value.
Counter mode 7 6 5 ON OFF					
S	Up/Down-A, B, C		Up/Down-D, E, F		Down, Up/Down-D, E, F input mode : Output maintains ON when counting display value is smaller or equal than setting value.
7 6 5 ON OFF					
S	Timer mode		Timer mode		Output turns OFF→ON→OFF repeatedly (flicker).
7 6 5 ON OFF					

※Set one-shot output time by front TIME volume switch.

■ Proper Usage

- Follow instructions in 'Proper Usage'. Otherwise, it may cause unexpected accidents.
- 24-48VDC, 24VAC power supply should be insulated and limited voltage/current or Class 2, SELV power supply device.
- Use the product, 0.1 sec after supplying power.
- When supplying or turning off the power, use a switch or etc. to avoid chattering.
- Install a power switch or circuit breaker in the easily accessible place for supplying or disconnecting the power.
- In case of contact input, set count speed to low speed mode (1cps or 30cps) to operate.
If set to high speed mode (2kcps or 5kcps), counting error occurs due to chattering.
- Keep away from high voltage lines or power lines to prevent inductive noise.
In case installing power line and input signal line closely, use line filter or varistor at power line and shielded wire at input signal line.
Do not use near the equipment which generates strong magnetic force or high frequency noise.
- This product may be used in the following environments.
 - ①Indoors (in the environment condition rated in 'Specifications')
 - ②Altitude max. 2,000m
 - ③Pollution degree 2
 - ④Installation category II