

**FEATURES**

1. There are various types of transducers, such as: transducer with extension cable/tube, Anti-corrosive type, flange type & pressure transducer.
2. Can be equipped with digital panel meter, recorder, PLC, signal controller.
3. The metal diaphragm is suitable in various environments such as weak acid and alkaline liquid or sewage water treatment.
4. Our internal temperature compensation ensures long lasting reliability.
5. Available in various flange/screw sizes.

**THEORY**

A pressure sensor is made up of a piezoresistor Wheatstone bridge.

As shown in fig.2, the pressure is applied to the diaphragm and passes through the silicon oil onto the Wheatstone bridge.

When the liquid pressure acts directly on the front face of diaphragm, the Wheatstone bridge will create a differential voltage. This voltage difference will then be amplified to obtain a current signal of 4-20mA. When this current output is connected to an analog meter, we can scale properly to read the level of the applied liquid in a container or a vessel.

The formula used here is:  $P = \theta \times H$

Where P is pressure,  $\theta$  is pressure constant and H is the level of liquid in a container.

**APPLICATIONS**

1. EC1100 is a liquid measurement device which can be used in a variety of environments, including water-agitation environments.
2. EC1200 can withstand high temperature liquid environment.
3. The Standard Flange Type, EC1210 can be used in liquid & gas pressure measurement environments (i.e., mildly corrosive environments).
4. EC1300~1320 type is suitable for measurement of very deep water, such as measurement of reservoirs.
5. EC1500 is suitable for pressure measurement or control devices such as those found in hydraulic and pneumatic machines.

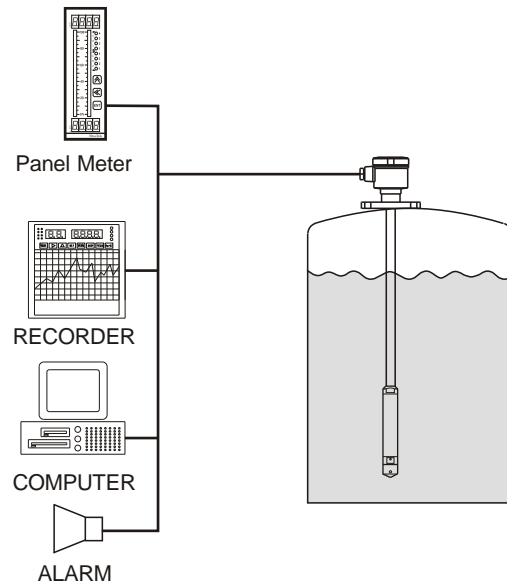
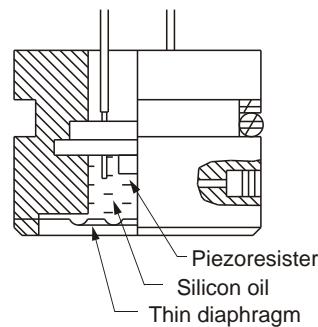

Fig. (1)



$P = \theta \times H$   
 P : Pressure  
 H: The level of liquid  
 $\theta$  : Pressure constant

Fig. (2)

# SPECIFICATION

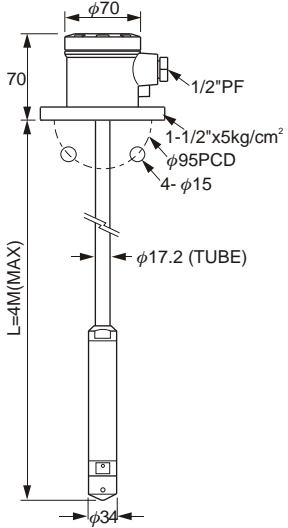
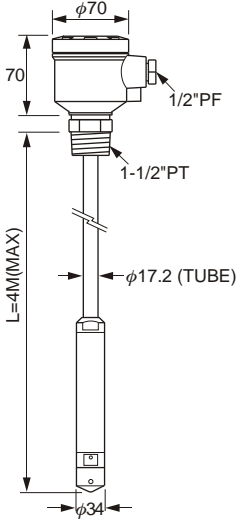
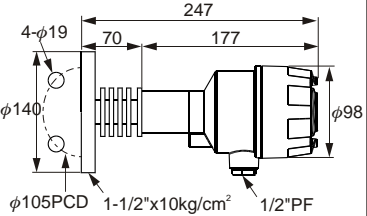
<b>Dimensions</b> (unit:mm)			
<b>Model No.</b>	<b>EC1100</b> Extension Tube Flange Type	<b>EC1110</b> Extension Tube Screw Type	<b>EC1200 Hi-Temp.</b> Flange Type
<b>Housing material</b>	Aluminum, IP65	Aluminum, IP65	Aluminum, IP65
<b>Pressure range</b>	0.1, 0.2, 0.4 bar	0.1, 0.2, 0.4 bar	0.1, 0.2, 0.5, 1, 2, 5, 10 bar
<b>Measuring range</b>	0~1M, 0~2M, 0~4M (assumed with the water S.G:1)	0~1M, 0~2M, 0~4M (assumed with the water S.G:1)	0~1M, 0~2M, 0~5M, 0~10M, 0~20M, 0~50M, 0~100M (assumed with the water S.G:1)
<b>Linearity</b>	0.3%FS	0.3%FS	0.3%FS
<b>Long term stability</b>	<0.1%	<0.1%	<0.1%
<b>Operating temp</b>	-10~80°C	-10~80°C	-10~150°C
<b>Ambient temp</b>	60°C	60°C	60°C
<b>Supply voltage</b>	13~36 Vdc	13~36 Vdc	13~36 Vdc
<b>Output</b>	4~20mA, Loop resistance should be less than 500 W	4~20mA, Loop resistance should be less than 500 W	4~20mA, Loop resistance should be less than 500 W
<b>Connection</b>	1-1/2" x 5kg/cm <sup>2</sup>	1-1/2" PT	1-1/2" x 10kg/cm <sup>2</sup>
<b>Wetted material</b>	SUS 304/316	SUS 304/316	SUS 304/316
<b>Weight</b>	approx. 4.2kg (L=1M)	approx. 4kg (L=1M)	approx. 1.8kg (L=1M)

※Special size flange and screws are available.

※OEM/ODM is welcome.

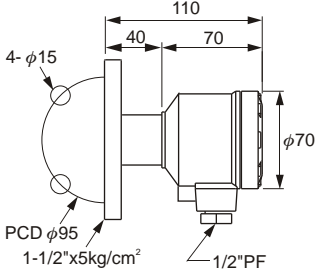
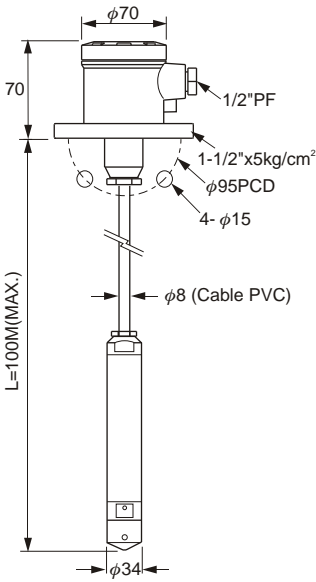
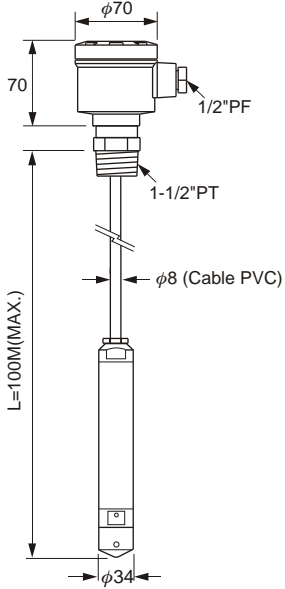
<b>Dimensions</b> (unit:mm)			
<b>Model No.</b>	<b>EC1210</b> Flange Standard Type	<b>EC1300</b> Extension Cable Flange Type	<b>EC1310</b> Extension Cable Screw Type
<b>Housing material</b>	Aluminum, IP65	Aluminum, IP65	Aluminum, IP65
<b>Pressure range</b>	0.1, 0.2, 0.4 bar	0.1, 0.2, 0.5, 1, 2, 5, 10 Bar	0.1, 0.2, 0.4, 1, 2, 5, 10 Bar
<b>Measuring range</b>	0~1M,0~2M,0~4M (assumed with the water S.G:1)	0~1M,0~2M,0~5M,0~10M, 0~20M,0~50M,0~100M (assumed with the water S.G:1)	0~1M,0~2M,0~4M,0~10M, 0~20M,0~50M,0~100M (assumed with the water S.G:1)
<b>Linearity</b>	0.3%FS	0.3%FS	0.3%FS
<b>Long term stability</b>	<0.1%	<0.1%	<0.1%
<b>Operating temp</b>	-10~80°C	-10~80°C	-10~80°C
<b>Ambient temp</b>	60°C	60°C	60°C
<b>Supply voltage</b>	13~36 Vdc	13~36 Vdc	13~36 Vdc
<b>Output</b>	4~20mA,Loop resistance should be less than 500 W	4~20mA,Loop resistance should be less than 500 W	4~20mA,Loop resistance should be less than 500 W
<b>Connection</b>	1-1/2" x 5kg/cm <sup>2</sup>	1-1/2"x5kg/cm <sup>2</sup>	1-1/2"PT
<b>Wetted material</b>	SUS 304/316	SUS 304/316	SUS 304/316
<b>Weight</b>	approx. 1.5kg	approx. 2.8kg (L=1M)	approx. 2.9kg (L=1M)

※Special size flange and screws are available.

※OEM/ODM is welcome.

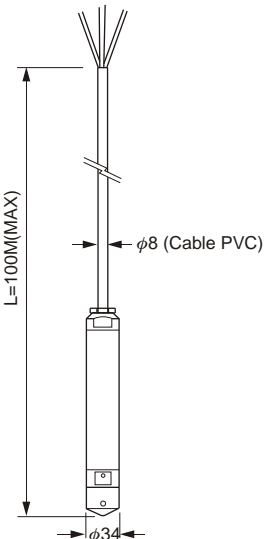
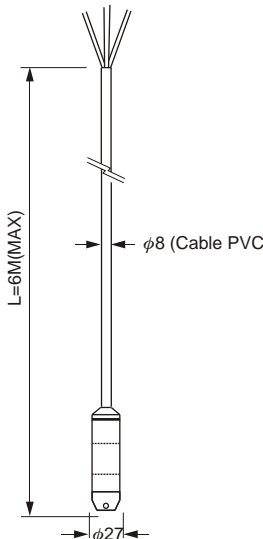
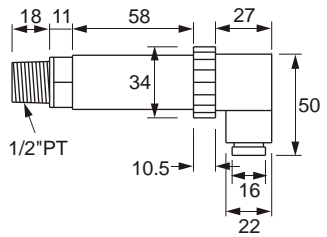
Dimensions (unit:mm)			
<b>Model No.</b>	<b>EC1320 Extension Cable Type</b>	<b>EC2500 Extension Cable Type</b>	<b>EC1500 Pressure Transducer</b>
<b>Pressure range</b>	0.1,0.2,0.5,1,2,5,10 bar	0.25, 0.4, 0.6 bar	0.1,0.2,0.5,1,2,5,10,20,50,100 bar
<b>Measuring range</b>	0~1M,0~2M,0~5M,0~10M, 0~20M,0~50M,0~100M (assumed with the water S.G:1)	0~2.5M,0~4M,0~6M (assumed with the water S.G:1)	—————
<b>Linearity</b>	0.3%FS	0.3%FS	0.3%FS
<b>Long term stability</b>	<0.1%	<0.1%	<0.1%
<b>Operating temp</b>	-10~80°C	-10~80°C	-10~80°C
<b>Ambient temp</b>	60°C	60°C	60°C
<b>Supply voltage</b>	13~36 Vdc	13~36 Vdc	13~36 Vdc
<b>Output</b>	4~20mA,Loop resistance should be less than 500 W	4~20mA,Loop resistance should be less than 500 W	4~20mA,Loop resistance should be less than 500 W
<b>Protection</b>	—————	—————	1/2" PT
<b>Wetted material</b>	SUS 304/316	SUS 316	SUS 304/316
<b>Weight</b>	approx. 0.8kg (L=1M)	approx. 0.8kg (L=1M)	approx. 250g

※Special size flange and screws are available.

※OEM/ODM is welcome.

# INTERNAL WIRING

1. Make sure the power is turned off. Connect them as show in fig.3, 4 or 5 (depend on which model you purchased).
2. Make sure the outlet breather capillary is open for air to flow freely.
3. Please tighten cover and cable gland after wiring finished.
4. The cable should be at least 18 AWG or 16AWG.

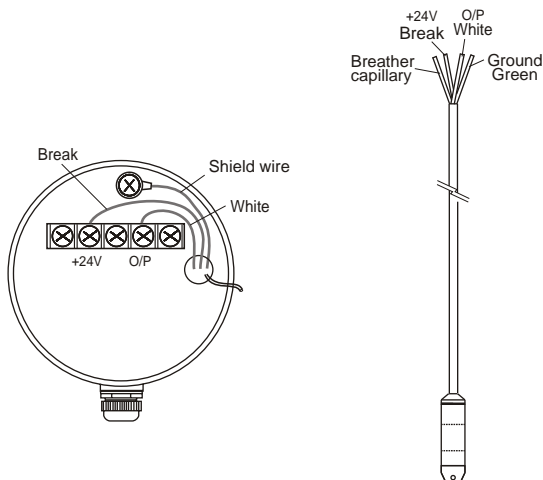

Fig. (3)

EC1100, EC1110, EC1300, EC1310

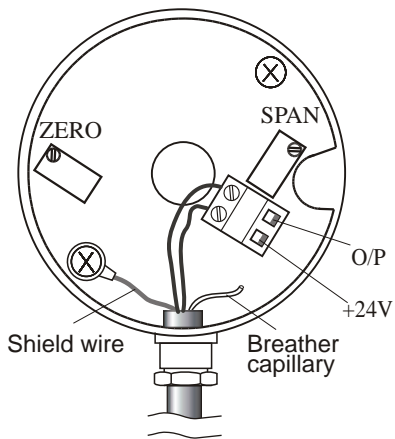

Fig. (4)

EC1200, EC1210

## EC1500 TYPE

1. Remove the cover of plug and connect cable to the terminal of plug.

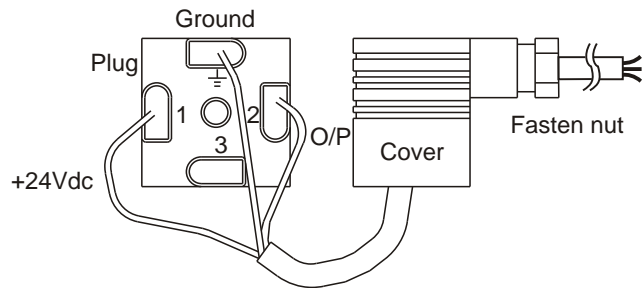

Fig. (5)

2. When wiring is finished, assemble the plug with cover.

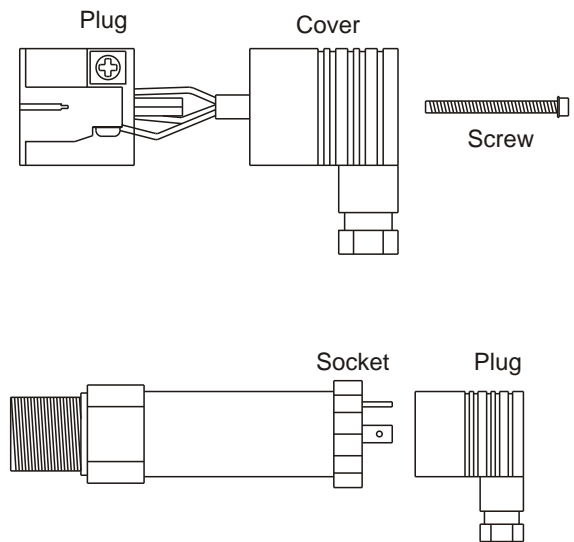

Fig. (6)

# EXTERNAL WIRING

1. For FineTek Panel Meter, please refer to the wiring diagram attached. As for other brands of panel meter, please refer to its respective operation manual for their wiring diagram.
2. Wiring connection should be kept away from high voltage cable, (e.g. Power cable.) to prevent interference from high voltage.
3. Resistance in the circuit should be avoid for wiring connection in order to keep operating voltage higher than 13Vdc
4. Wiring should be used in shielded insulated cable.
5. If the panel meter does not supply 24Vdc power supply to the sensor, additional power supply is needed as according to Diagram 8. If installing 2 panel meters at different location, please refer to diagram 9 for wire connection.

EC1100~1110,1300~1310  
Inside view

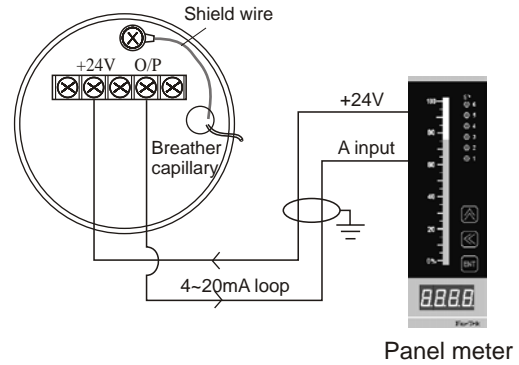

Fig. (7)

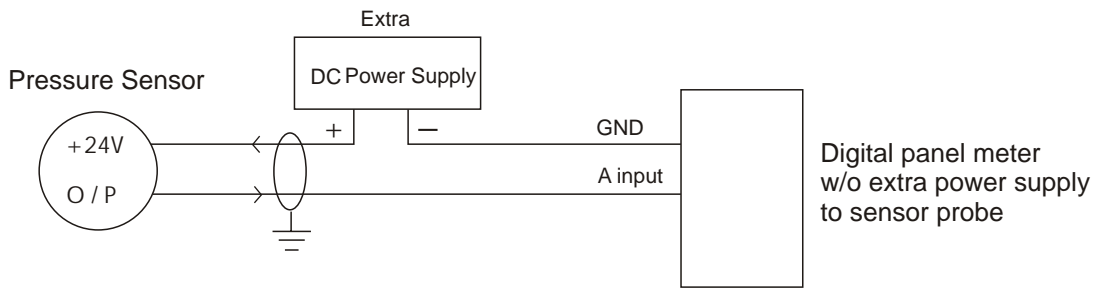

Fig. (8)

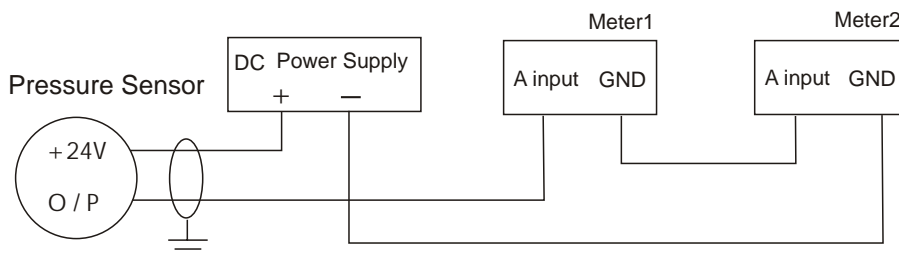
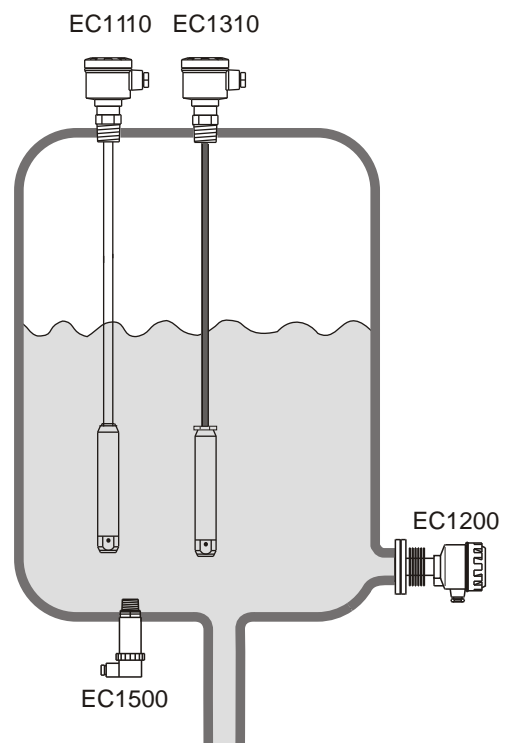
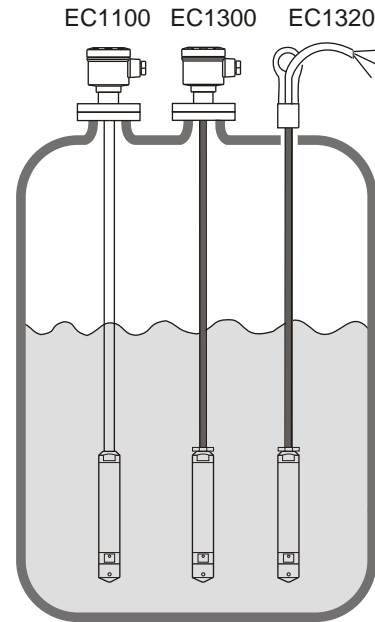

Fig. (9)

## INSTALLATION

1. The transducer with extension cable & types are equipped with an electrical housing standing vertically and with a screw-type of cap on top.
2. The flange type transducer is equipped with a side mounted electrical housing.
3. A special type of cable is used in the transducer with extension cable. Please note that this cable comes with 3 multi-thread copper wire and a breather capillary. Therefore, any bending of the cable is not recommended. Otherwise, the measurements will not be accurate.
4. It is recommended that you use EC1200, when the pressure level measurement of solvent is implemented.
5. Do not use liquid that will crystallize or solidify in all of your pressure transducer.
6. All our pressure transducers are designed to perform in an environment with temperature equal to or less than 80°C (except EC1200). If the desired operation temperature is more than 80°C, please consult with our business representative.
7. The tank or vessel should not be vacuum or where no pressure can be applied to the tank or vessel.
8. Handle the sensor probe with care. The sensor probe is extremely delicate, any extra vibration or shock will damage it.
9. Do not use high pressure jet of water to wash the sensing diaphragm.



# ADJUSTMENT (FOR ZERO-SPAN)

- Adjust the trimmer "ZERO" while the tank is empty to make sure the current output was expected to reach 4mA.
- Adjust the trimmer "SPAN" while the tank is full to make sure the current output was expected to reach 20mA.
- Since Zero & Span adjustment were all done in the factory before shipment, do not perform the above adjustments unless it is really necessary.
- Adjust range: (SPAN) 18~24mA, (ZERO) 3~5mA.
- If the sensor output is not a standard 4~20mA signal while liquid level changes between empty and full, we recommend you to use with the PM series digital meter, because which equipped with a built-in programmable input (0~25.5mA) to allows the user to set his configuration. This special function will keep the reading of meter correspond to the any different input signal. More information please refers to Panel Meter series catalog.

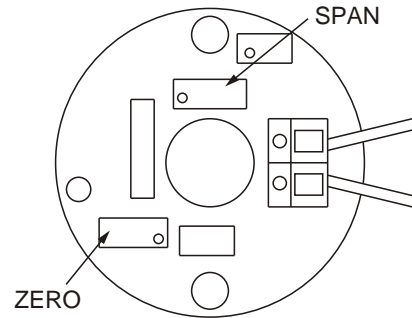

The electrical housing for transducer with flange.

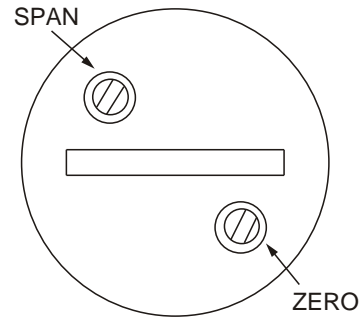

The electrical housing for pressure transducer.

## Pressure Unit Conversion Constants

	PSI	KPa	mbar	cmH <sub>2</sub> O	mmHg	kgf/cm <sup>2</sup>
PSI	1	6.89	68.95	70.31	51.71	70.31x10 <sup>-3</sup>
KPa	0.15	1	10	10.2	7.5	1.02x10 <sup>-2</sup>
mbar	1.45x10 <sup>-2</sup>	0.1	1	1.02	0.75	1.02x10 <sup>-3</sup>
cmH <sub>2</sub> O	14.22x10 <sup>-3</sup>	98.07x10 <sup>-3</sup>	0.98	1	0.74	10 <sup>-3</sup>
mmHg	19.34x10 <sup>-3</sup>	13.33x10 <sup>-2</sup>	1.33	1.36	1	1.36x10 <sup>-3</sup>
kgf/cm <sup>2</sup>	14.22	98.07	980.67	1000	735.56	1

1 MPa=10.2kgf/cm<sup>2</sup>=145 PSI

1 kgf/cm<sup>2</sup>=0.098MPa=14.22 PSI



# HOW TO MAKE YOUR ORDER

EC 1110 0 EM (0100)

**MODEL**

- |                                  |                                 |
|----------------------------------|---------------------------------|
| 110: Extension Tube Flange Type  | 131: Extension Cable Screw Type |
| 111: Extension Tube Screw Type   | 132: Extension Cable Type       |
| 120: Hi-Temp. Flange Type        | 150: Pressure Transducer        |
| 121: Flange Standard Type        | (Custom-made)                   |
| 130: Extension Cable Flange Type | 151: Pressure Transducer        |
|                                  | 175: Extension Type             |

**WETTED MATERIAL**

- |                               |           |         |
|-------------------------------|-----------|---------|
| 0: SUS304                     | 6: SUS316 | E: PTFE |
| (EC130 Extension Cable Type ) |           |         |

**CONNECTING TYPE**

- |                 |               |                          |                 |
|-----------------|---------------|--------------------------|-----------------|
| B: 1/2" (15A)   | I : 4" (100A) | M: 5 kg/cm <sup>2</sup>  | U: NPT          |
| C: 3/4" (20A)   | J: 5" (125A)  | N: 10 kg/cm <sup>2</sup> | W: PN10 (10Bar) |
| D: 1" (25A)     | K: 6" (150A)  | O: 150 Lbs               | X: PN16 (16Bar) |
| E: 1-1/2" (40A) | S: Others     | P: 300 Lbs               | Y: PN25 (25Bar) |
| F: 2" (50A)     |               | Q: PT                    | Z: PN40 (40Bar) |
| G: 2-1/2" (65A) |               | R: PF(G)                 | S: Others       |
| H: 3" (80A)     |               | T: BSP                   | -: None         |

**PROBE LENGTH (unit: m)**

- 0050: below 0.5m  
 0100: 1m  
 0150: 1.5m                      ※ 0.5m per Unit  
 ⋮

EC 2500 EM(0) (0100)

**MODEL**

- 250: Extension Cable Type

**PRESSURE (BAR)**

- X25=0.25bar    X4=0.4bar    X6=0.6bar

**PROBE LENGTH (unit: mm)**

- 0050: below 0.5m  
 0100: 1m.  
 0150: 1.5m                      ※ 0.5m per Unit

- \* Tolerance of the total product length is ±5mm
- \* Characteristics, specifications and dimensions are subject to change without notice.
- \* Please contact your nearest distributing office for further informations.