

## Intelligent Display Unit

## Intelligent Display Unit

### ■ Features

- Simple wiring without soldering
  - : multi-stage connection using expansion connectors or ribbon cables.
  - : power supply and data wiring required on base unit only.
- Various input options
  - : Serial input
  - : Parallel input
  - : RS485 communication input
  - : RS485 communication time sync display
  - : PT temperature sensor input
  - : PT temperature sensor + RS485 communication input
- Expandable up to 24 units with multi-stage connection
- Available in various sizes: 16mm, 22.5mm, 40mm, 60mm
- Available in 7-segment display and 16-segment display types
- Available in red display and green display types
- High luminance LED display
- Various unit display plates (switchable) with flashing or ON/OFF options
- Display 64 unique characters (0 to 9, A to Z, 27 symbols, period)



 Please read "Safety Considerations" in operation manual before using.



### ■ Ordering Information

**D S 16 - R S**

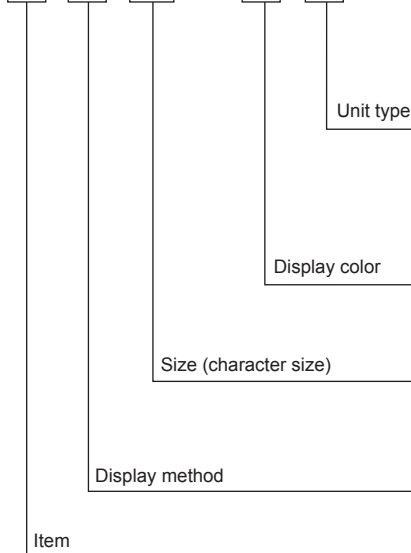

S	Basic unit	Serial input
P		Parallel input
T		RS485 comm. input
C		RS485 synchronous comm. type for time display
R		Pt temp. sensor input
RT		Pt temp. sensor input+RS485 comm. output
E	Expansion unit	
No-mark	Unit-display unit	
R <sup>※3</sup>	Red	
G	Green	
16 <sup>※1</sup>	W16×H24mm (W9.0×H16.0mm)	
22	W20×H33mm (W11.2×H22.5mm)	
40	W40×H60mm (W22.4×H40.0mm)	
60	W60×H96mm (W33.6×H60.0mm)	
S	7-segment	
A	16-segment	
U <sup>※2</sup>	Unit-display unit	
D	Display unit	

※1: The '16' size model has the serial input model, RS485 comm. input model and does not support 16-segment display method.

※2: Unit-display unit has only 16, 22 size.

※3: Pt temp. sensor input, Pt temp. sensor input+RS485 comm. output models support only red display color.

# DS/DA Series

## ■ Specifications

### ◎ Serial / Parallel / RS485 communication input type

Model	Basic unit	DS16-□S/T	D□22-□S/P/T	D□40-□S/P/T	D□60-□S/P/T
	Expansion unit	DS16-□E	D□22-□E	D□40-□E	D□60-□E
Input method	D□□□S: Serial				
	D□□□P: Parallel (dynamic parallel 1, dynamic parallel 2)				
	D□□□T: RS485 communication (modbus protocol)				
Display color	Red, green (selectable by model)				
Power supply	12-24VDC=				
Allowable voltage range	90 to 110% of rated voltage				
Current consumption	Red	Max. 20mA	Max. 25mA	Max. 55mA	Max. 65mA
	Green	Max. 15mA	Max. 20mA	Max. 40mA	Max. 45mA
Character size	W9×H16mm		W11.2×H22.5mm	W22.4×H40mm	W33.6×H60mm
Max. Clock <sup>※1, ※2</sup>	<ul style="list-style-type: none"> <li>Serial input: max. 2kHz</li> <li>Parallel input - dynamic parallel 1: max. 3kHz, dynamic parallel 2: max. 1.5kHz</li> </ul>				
Input logic <sup>※1</sup>	Selectable positive logic (PNP), negative logic (NPN) (change by the function set switch)				
Input resistance <sup>※1</sup>	20kΩ				
Input level <sup>※1</sup>	High: 4.5-24VDC=, low: 0-1.2VDC=				
Display character	64 characters and signs (0 to 9, A to Z, 27 symbols, decimal point)				
Max. connection	Serial / RS485 comm. input: 24 units				
	Parallel input - dynamic parallel 1: 6 units (4-bit), 4 units (6-bit), dynamic parallel 2: 24 units (6-bit)				

※1: It is only for Serial, Parallel input models.

※2: Max. Clock is for 1:1 of duty ratio (ON, OFF ratio).

### ◎ RS485 synchronous communication type for time display

Model	Basic unit	DS22-□C	DS40-□C	DS60-□C
	Expansion unit	D□22-□E	D□40-□E	D□60-□E
Input method	RS485 communication (modbus protocol)			
Display color	Red, green (selectable by model)			
Power supply	12-24VDC=			
Allowable voltage range	90 to 110% of rated voltage			
Current consumption	Red	Max. 25mA	Max. 55mA	Max. 65mA
	Green	Max. 20mA	Max. 40mA	Max. 45mA
Character size	W11.2×H22.5mm		W22.4×H40mm	W33.6×H60mm
Time display	World local time, 12/24-hour, summer time supported			
Max. connection	10 units			

※1: Use 16-segment expansion unit for displaying delimiter for hour/min/sec and 'M' character for AM/PM.

### ◎ Pt temp. sensor input / Pt temp. sensor input + RS485 communication output type

Model	Basic unit	DS22-RR	DS40-RR/RRT	DS60-RR/RRT
	Expansion unit	DS22-RE	DS40-RE	DS60-RE
Input method	Pt temp. sensor input (supports DPt100Ω, JPt 100Ω)			
Display color	Red			
Power supply	12-24VDC=			
Allowable voltage range	90 to 110% of rated voltage			
Current consumption	Max. 40mA		Max. 55mA	Max. 65mA
Character size	W11.2×H22.5mm		W22.4×H40mm	W33.6×H60mm
Display temp. range	-50.0 to 400.0°C or -58.0 to 752.0°F			
Display accuracy	F.S.±0.5%			
Output	—		RS485 comm. output (modbus RTU) <sup>※1</sup>	
Max. connection	4 units (except unit-display unit)			

※1: RS485 comm. output supports only DS40-RRT, DS60-RRT models.

# Intelligent Display Unit

## ◎ General Specifications

Model	Basic unit	DS16-□S/T	D□22-□S/P/T/C/R	D□40-□S/P/T/C/R/RT	D□60-□S/P/T/C/R/RT
	Expansion unit	DS16-□E	D□22-□E	D□40-□E	D□60-□E
Noise immunity		±500V the square wave noise (pulse width: 1μs) by the noise simulator			
Environment	Ambient temp.	-10 to 55°C, storage: -25 to 65°C			
	Ambient humi.	35 to 85%RH, storage: 35 to 85%RH			
Accessory	Basic unit	Right/Left cap: 1	Right/Left cap: 1 Connector: 1	Connector: 1 <sup>※1</sup>	
	Expansion unit	—		Ribbon cable (50mm): 1	
Protection structure		IP40 (front part)			
Approval		CE			
Weight <sup>※2</sup>	Basic unit	Approx. 52g (approx. 12g)	Approx. 58g (approx. 17g)	Approx. 63g (approx. 28g)	Approx. 110g (approx. 60g)
	Expansion unit	Approx. 77g (approx. 12g) <sup>※3</sup>	Approx. 92g (approx. 17g) <sup>※3</sup>	Approx. 63g (approx. 28g)	Approx. 110g (approx. 60g)

※1: It is only for parallel input model.

※2: The weight includes packaging. The weight in parenthesis is for unit only.

※3: The weight represents a pack of 3 units. The weight in parenthesis is for 1 unit only.

※Environment resistance is rated at no freezing or condensation.

## ■ Unit Description and Function Setting

Only the basic unit model has the function set switch and the input terminal.

The DS16, D□22 models have them at the side, and the D□40, D□60 models have them at the rear.

### ◎ Serial input model

#### ① Expansion connector

Using for connecting units.

Refer to '■ Connection of units'.

#### ● DS16-□S

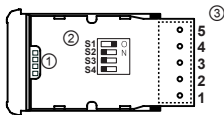

#### ● D□22-□S

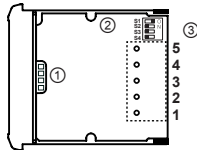

#### ● D□40-□S

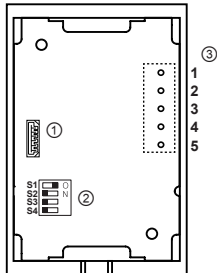

#### ● D□60-□S

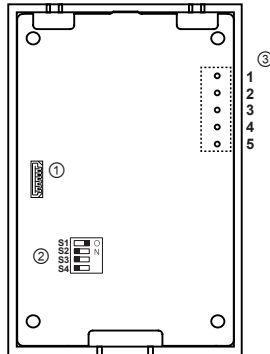

#### ② Function set switches



No.	Switch		Function
	OFF (■)	ON (■)	
S1	Positive logic (PNP)	Negative logic (NPN)	Input logic
S2	Not used	Used	Zero Blanking
S3	Not used	Used	Decimal number display <sup>※1</sup>
S4	8-bit	5-bit <sup>※2</sup>	Data input bit

※1: The other data except 0 to 9 are blank.

※2: 5-bit data input is compatible with Autonics panel meter (MT4Y, MT4W).

#### ③ Input terminal

No.	Code	Function
1	VCC	12-24VDC
2	GND	0V
3	Data	Data input
4	CLOCK	CLOCK input
5	LATCH	LATCH input

※For the D□22-□S, connect the connector to input terminal.

# DS/DA Series

## ② Parallel input model

### ① Expansion connector

Using for connecting units.

Refer to '■ Connection of units'.

#### ● D□22-□P

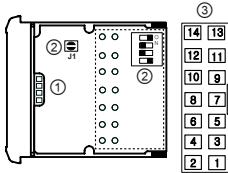

#### ● D□40-□P

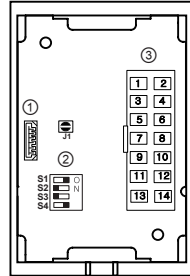

#### ● D□60-□P

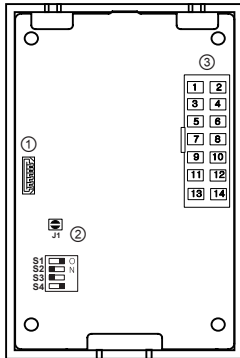

### ② Function set switches

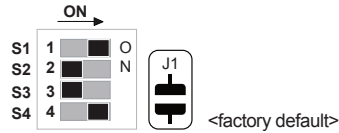

No.	Switch		Function
	OFF (■)	ON (■)	
S1	Positive logic (PNP)	Negative logic (NPN)	Input logic
S2	Not used	Used	Zero Blanking
S3	6-bit	4-bit <sup>※1,※2</sup>	Data input bit
S4	Dynamic 1	Dynamic 2	Dynamic 1/2 selection
J1			All Zero Blanking <sup>※3</sup>

※1: 4-bit data input is compatible with Autonics pulse meter (MP5Y, MP5W) and panel meter (MT4Y, MT4W).

※2: 4-bit data input displays "-" or "-1" when dot display data at the lowest display unit.

(minus display function is available when Zero Blanking, or All Zero Blanking is set as ON)

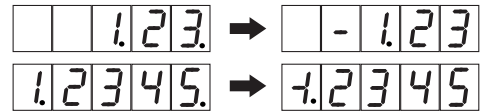

※3: When every number is '0', it becomes All Zero Blanking.

E.g.) When displaying 000045 using two basic units, Uses All Zero Blanking



Does not use All Zero Blanking



### ③ Input terminal

Terminal	Dynamic parallel 1				Dynamic parallel 2 <sup>※1</sup>	
	4-bit data input		6-bit data input		6-bit data input	
	Code	Function	Code	Function	Code	Function
1	VCC	12-24VDC	VCC	12-24VDC	VCC	12-24VDC
2	GND	0V	GND	0V	GND	0V
3	LE5	LATCH 5	LE3	LATCH 3	LATCH	LATCH input
4	LE4	LATCH 4	LE2	LATCH 2	CLOCK	CLOCK input
5	LE3	LATCH 3	LE1	LATCH 1	—	—
6	LE2	LATCH 2	LE0	LATCH 0	UNIT	Unit
7	LE1	LATCH 1	DP	Decimal point	DP	Decimal point
8	LE0	LATCH 0	D5	2 <sup>5</sup> Data	D5	2 <sup>5</sup> Data
9	DP	Decimal point	D4	2 <sup>4</sup> Data	D4	2 <sup>4</sup> Data
10	D3	2 <sup>3</sup> Data	D3	2 <sup>3</sup> Data	D3	2 <sup>3</sup> Data
11	D2	2 <sup>2</sup> Data	D2	2 <sup>2</sup> Data	D2	2 <sup>2</sup> Data
12	D1	2 <sup>1</sup> Data	D1	2 <sup>1</sup> Data	D1	2 <sup>1</sup> Data
13	D0	2 <sup>0</sup> Data	D0	2 <sup>0</sup> Data	D0	2 <sup>0</sup> Data
14	GND	0V	GND	0V	GND	0V

※1: When selecting Dynamic Parallel 2, 6-bit data input, All Zero Blanking OFF are fixed.

# Intelligent Display Unit

## ③ RS485 communication input model

### ① Expansion connector

Using for connecting units.

Refer to '■ Connection of units'.

#### ● DS16-□T

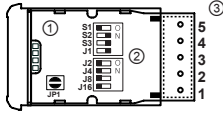

#### ● D□22-□T

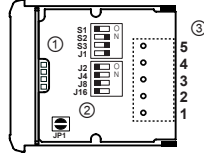

#### ● D□40-□T

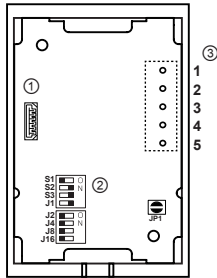

#### ● D□60-□T

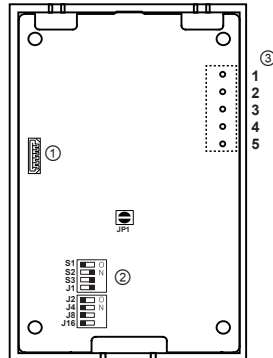

### ② Function set switches

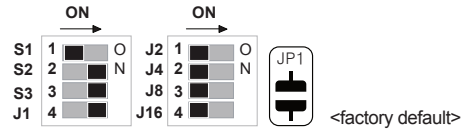

※Functions are varied by JP1 setting (RS485 master mode/RS485 slave mode).

#### ●RS485 slave mode (JP1 (open))

No.	Switch OFF( <input type="checkbox"/> ) / ON( <input type="checkbox"/> )	Function																									
S1	5ms <input type="checkbox"/> 20ms <input type="checkbox"/>	Comm. response time																									
S2	4800 <input type="checkbox"/> 9600 <input type="checkbox"/> 19200 <input type="checkbox"/> 38400 <input type="checkbox"/>	Comm. speed selection (bps)																									
S3	S2 <input type="checkbox"/> S3 <input type="checkbox"/>																										
J1 to J16	<table border="1"> <tr> <td>J1</td> <td>1 <input type="checkbox"/></td> <td>2 <input type="checkbox"/></td> <td>31 <input type="checkbox"/></td> <td>32 <input type="checkbox"/></td> </tr> <tr> <td>J2</td> <td><input type="checkbox"/></td> <td><input type="checkbox"/></td> <td><input type="checkbox"/></td> <td><input type="checkbox"/></td> </tr> <tr> <td>J4</td> <td><input type="checkbox"/></td> <td><input type="checkbox"/></td> <td>...</td> <td><input type="checkbox"/></td> </tr> <tr> <td>J8</td> <td><input type="checkbox"/></td> <td><input type="checkbox"/></td> <td><input type="checkbox"/></td> <td><input type="checkbox"/></td> </tr> <tr> <td>J16</td> <td><input type="checkbox"/></td> <td><input type="checkbox"/></td> <td><input type="checkbox"/></td> <td><input type="checkbox"/></td> </tr> </table>	J1	1 <input type="checkbox"/>	2 <input type="checkbox"/>	31 <input type="checkbox"/>	32 <input type="checkbox"/>	J2	<input type="checkbox"/>	<input type="checkbox"/>	<input type="checkbox"/>	<input type="checkbox"/>	J4	<input type="checkbox"/>	<input type="checkbox"/>	...	<input type="checkbox"/>	J8	<input type="checkbox"/>	<input type="checkbox"/>	<input type="checkbox"/>	<input type="checkbox"/>	J16	<input type="checkbox"/>	<input type="checkbox"/>	<input type="checkbox"/>	<input type="checkbox"/>	Comm. address selection
J1	1 <input type="checkbox"/>	2 <input type="checkbox"/>	31 <input type="checkbox"/>	32 <input type="checkbox"/>																							
J2	<input type="checkbox"/>	<input type="checkbox"/>	<input type="checkbox"/>	<input type="checkbox"/>																							
J4	<input type="checkbox"/>	<input type="checkbox"/>	...	<input type="checkbox"/>																							
J8	<input type="checkbox"/>	<input type="checkbox"/>	<input type="checkbox"/>	<input type="checkbox"/>																							
J16	<input type="checkbox"/>	<input type="checkbox"/>	<input type="checkbox"/>	<input type="checkbox"/>																							

#### ●RS485 master mode (JP1 (short))

No.	Switch OFF( <input type="checkbox"/> ) / ON( <input type="checkbox"/> )	Function																																				
S1	Manual setting <input type="checkbox"/> Auto setting <input type="checkbox"/>	Series setting method																																				
S2	4800 <input type="checkbox"/> 9600 <input type="checkbox"/> 19200 <input type="checkbox"/> 38400 <input type="checkbox"/>	Comm. speed selection (bps)																																				
S3	S2 <input type="checkbox"/> S3 <input type="checkbox"/>																																					
J1 to J8	<table border="1"> <tr> <td>J1</td> <td>CT6 <input type="checkbox"/></td> <td>CT4 <input type="checkbox"/></td> <td>MP5 <input type="checkbox"/></td> <td>MT4 <input type="checkbox"/></td> <td>TK/TX <input type="checkbox"/></td> <td>TM2 <input type="checkbox"/></td> <td>TM4 <input type="checkbox"/></td> <td>THD <input type="checkbox"/></td> </tr> <tr> <td>J2</td> <td><input type="checkbox"/></td> <td><input type="checkbox"/></td> <td><input type="checkbox"/></td> <td><input type="checkbox"/></td> <td><input type="checkbox"/></td> <td><input type="checkbox"/></td> <td><input type="checkbox"/></td> <td><input type="checkbox"/></td> </tr> <tr> <td>J4</td> <td><input type="checkbox"/></td> <td><input type="checkbox"/></td> <td><input type="checkbox"/></td> <td><input type="checkbox"/></td> <td><input type="checkbox"/></td> <td><input type="checkbox"/></td> <td><input type="checkbox"/></td> <td><input type="checkbox"/></td> </tr> <tr> <td>J8</td> <td><input type="checkbox"/></td> <td><input type="checkbox"/></td> <td><input type="checkbox"/></td> <td><input type="checkbox"/></td> <td><input type="checkbox"/></td> <td><input type="checkbox"/></td> <td><input type="checkbox"/></td> <td><input type="checkbox"/></td> </tr> </table>	J1	CT6 <input type="checkbox"/>	CT4 <input type="checkbox"/>	MP5 <input type="checkbox"/>	MT4 <input type="checkbox"/>	TK/TX <input type="checkbox"/>	TM2 <input type="checkbox"/>	TM4 <input type="checkbox"/>	THD <input type="checkbox"/>	J2	<input type="checkbox"/>	<input type="checkbox"/>	<input type="checkbox"/>	<input type="checkbox"/>	<input type="checkbox"/>	<input type="checkbox"/>	<input type="checkbox"/>	<input type="checkbox"/>	J4	<input type="checkbox"/>	<input type="checkbox"/>	<input type="checkbox"/>	<input type="checkbox"/>	<input type="checkbox"/>	<input type="checkbox"/>	<input type="checkbox"/>	<input type="checkbox"/>	J8	<input type="checkbox"/>	<input type="checkbox"/>	<input type="checkbox"/>	<input type="checkbox"/>	<input type="checkbox"/>	<input type="checkbox"/>	<input type="checkbox"/>	<input type="checkbox"/>	Series selection (manual setting)
J1	CT6 <input type="checkbox"/>	CT4 <input type="checkbox"/>	MP5 <input type="checkbox"/>	MT4 <input type="checkbox"/>	TK/TX <input type="checkbox"/>	TM2 <input type="checkbox"/>	TM4 <input type="checkbox"/>	THD <input type="checkbox"/>																														
J2	<input type="checkbox"/>	<input type="checkbox"/>	<input type="checkbox"/>	<input type="checkbox"/>	<input type="checkbox"/>	<input type="checkbox"/>	<input type="checkbox"/>	<input type="checkbox"/>																														
J4	<input type="checkbox"/>	<input type="checkbox"/>	<input type="checkbox"/>	<input type="checkbox"/>	<input type="checkbox"/>	<input type="checkbox"/>	<input type="checkbox"/>	<input type="checkbox"/>																														
J8	<input type="checkbox"/>	<input type="checkbox"/>	<input type="checkbox"/>	<input type="checkbox"/>	<input type="checkbox"/>	<input type="checkbox"/>	<input type="checkbox"/>	<input type="checkbox"/>																														
J1 to J8	<table border="1"> <tr> <td>J1</td> <td>CT6 <input type="checkbox"/></td> <td>MP5 <input type="checkbox"/></td> <td>MT4 <input type="checkbox"/></td> <td>TK/TX <input type="checkbox"/></td> </tr> <tr> <td>J2</td> <td><input type="checkbox"/></td> <td><input type="checkbox"/></td> <td><input type="checkbox"/></td> <td><input type="checkbox"/></td> </tr> <tr> <td>J4</td> <td><input type="checkbox"/></td> <td><input type="checkbox"/></td> <td><input type="checkbox"/></td> <td><input type="checkbox"/></td> </tr> <tr> <td>J8</td> <td><input type="checkbox"/></td> <td><input type="checkbox"/></td> <td><input type="checkbox"/></td> <td><input type="checkbox"/></td> </tr> </table>	J1	CT6 <input type="checkbox"/>	MP5 <input type="checkbox"/>	MT4 <input type="checkbox"/>	TK/TX <input type="checkbox"/>	J2	<input type="checkbox"/>	<input type="checkbox"/>	<input type="checkbox"/>	<input type="checkbox"/>	J4	<input type="checkbox"/>	<input type="checkbox"/>	<input type="checkbox"/>	<input type="checkbox"/>	J8	<input type="checkbox"/>	<input type="checkbox"/>	<input type="checkbox"/>	<input type="checkbox"/>	Series selection (manual setting), Not using the highest digit																
J1	CT6 <input type="checkbox"/>	MP5 <input type="checkbox"/>	MT4 <input type="checkbox"/>	TK/TX <input type="checkbox"/>																																		
J2	<input type="checkbox"/>	<input type="checkbox"/>	<input type="checkbox"/>	<input type="checkbox"/>																																		
J4	<input type="checkbox"/>	<input type="checkbox"/>	<input type="checkbox"/>	<input type="checkbox"/>																																		
J8	<input type="checkbox"/>	<input type="checkbox"/>	<input type="checkbox"/>	<input type="checkbox"/>																																		
J16	No <input type="checkbox"/> Yes <input type="checkbox"/>	Unit-display unit																																				

※Refer to "■ RS485 Master Mode".

### ③ Input terminal

No.	Code	Function
1	VCC	12-24VDC
2	GND	0V
3	—	—
4	A (+)	RS485 A (+)
5	B (-)	RS485 B (-)

※For D□22-□T connect the connector to input terminal.

# DS/DA Series

## ③ RS485 synchronous communication type for time display model

### ① Expansion connector

Using for connecting units.

Refer to '■ Connection of units'.

#### ● DS22-□C

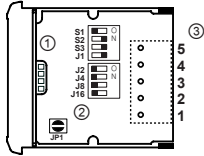

#### ● DS40-□C

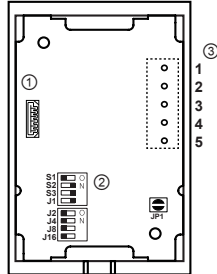

#### ● DS60-□C

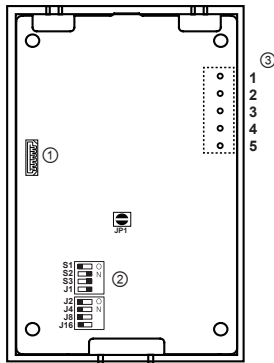

### ② Function set switches

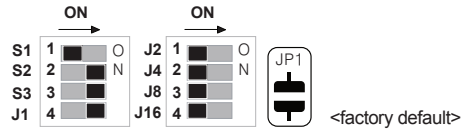

#### ● JP1 terminal setting

JP1	Delimiter for hour/min/sec
(Open)	Sign [.] (using 16-segment expansion unit)
(Short)	Period [.] (using 7-segment expansion unit)

#### ● Switch setting

No.	Switch OFF (■)/ON (■)	Function																														
S1	24-hour <input type="checkbox"/> 12-hour <input type="checkbox"/>	12/24-hour setting																														
S2	4800 <input type="checkbox"/> 9600 <input type="checkbox"/> 19200 <input type="checkbox"/> 38400 <input type="checkbox"/>	Comm. speed selection (bps)																														
S3	S2 <input type="checkbox"/> S3 <input type="checkbox"/>																															
J1 to J16	<table border="1"> <thead> <tr> <th></th> <th>UTC -12:00</th> <th>UTC -11:00</th> <th>UTC +11:00</th> <th>UTC +12:00</th> </tr> </thead> <tbody> <tr> <td>J1</td> <td><input type="checkbox"/></td> <td><input type="checkbox"/></td> <td><input type="checkbox"/></td> <td><input type="checkbox"/></td> </tr> <tr> <td>J2</td> <td><input type="checkbox"/></td> <td><input type="checkbox"/></td> <td><input type="checkbox"/></td> <td><input type="checkbox"/></td> </tr> <tr> <td>J4</td> <td><input type="checkbox"/></td> <td><input type="checkbox"/></td> <td>...</td> <td><input type="checkbox"/></td> </tr> <tr> <td>J8</td> <td><input type="checkbox"/></td> <td><input type="checkbox"/></td> <td><input type="checkbox"/></td> <td><input type="checkbox"/></td> </tr> <tr> <td>J16</td> <td><input type="checkbox"/></td> <td><input type="checkbox"/></td> <td><input type="checkbox"/></td> <td><input type="checkbox"/></td> </tr> </tbody> </table>		UTC -12:00	UTC -11:00	UTC +11:00	UTC +12:00	J1	<input type="checkbox"/>	<input type="checkbox"/>	<input type="checkbox"/>	<input type="checkbox"/>	J2	<input type="checkbox"/>	<input type="checkbox"/>	<input type="checkbox"/>	<input type="checkbox"/>	J4	<input type="checkbox"/>	<input type="checkbox"/>	...	<input type="checkbox"/>	J8	<input type="checkbox"/>	<input type="checkbox"/>	<input type="checkbox"/>	<input type="checkbox"/>	J16	<input type="checkbox"/>	<input type="checkbox"/>	<input type="checkbox"/>	<input type="checkbox"/>	World time zone selection <sup>※1</sup>
	UTC -12:00	UTC -11:00	UTC +11:00	UTC +12:00																												
J1	<input type="checkbox"/>	<input type="checkbox"/>	<input type="checkbox"/>	<input type="checkbox"/>																												
J2	<input type="checkbox"/>	<input type="checkbox"/>	<input type="checkbox"/>	<input type="checkbox"/>																												
J4	<input type="checkbox"/>	<input type="checkbox"/>	...	<input type="checkbox"/>																												
J8	<input type="checkbox"/>	<input type="checkbox"/>	<input type="checkbox"/>	<input type="checkbox"/>																												
J16	<input type="checkbox"/>	<input type="checkbox"/>	<input type="checkbox"/>	<input type="checkbox"/>																												

※1: Refer to "■ World Time Zone".

### ③ Input terminal

No.	Code	Function
1	VCC	12-24VDC
2	GND	0V
3	—	—
4	A (+)	RS485 A (+)
5	B (-)	RS485 B (-)

※For DS22-□C connect the connector to input terminal.

# Intelligent Display Unit

## ③ Pt temp. sensor input model

### ① Expansion connector

Using for connecting units.

Refer to '■ Connection of units'.

#### ● DS22-RR

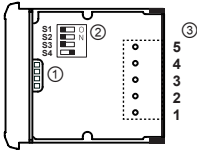

#### ● DS40-RR/RRT

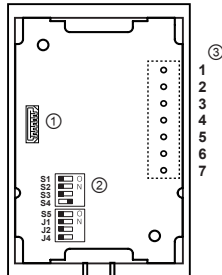

#### ● DS60-RR/RRT

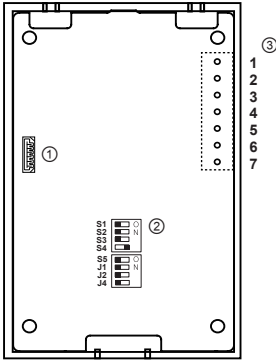

### ② Function set switches

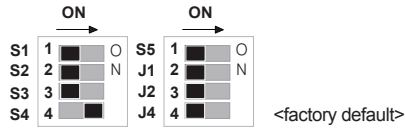

No.	Switch		Function
	OFF (■)	ON (■)	
S1	DPT100Ω	JPt100Ω	Temp. sensor
S2	°C	°F	Temp. unit
S3	10 <sup>2</sup>	10 <sup>1</sup>	Integer display
S4	Not used	Used	Decimal point
S5	9600bps	38400bps	Comm. speed selection (bps)
J1 J2 J4			Comm. address selection

### ③ Input terminal

No.	Code	Function
1	VCC	12-24VDC
2	GND	0V
3	A	Pt temp. sensor A
4	B	Pt temp. sensor B
5	B'	Pt temp. sensor B'
6	A (+)	RS485 A (+)
7	B (-)	RS485 B (-)

#### ● Connections

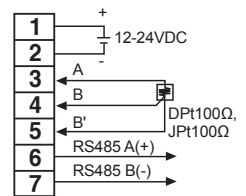

※For DS22-RR connect the connector to input terminal.

※Function set switches S5, J1, J2, J4 and input terminal 6, 7 are only for RS485 comm. output models (DS40-RRT, DS60-RRT).

## ■ Unit-display Unit

This unit is for displaying unit by inserting a name plate. It has only 16, 22 sizes. (sold separately)

### ③ Unit name plates

It provides unit-printed name plates as an accessory. You can select the desired unit name plate and insert this plate. (single-stage unit name plate: 19 types, dual-stage unit name plate: 2 types)



Single-stage unit name plate



Dual-stage unit name plate

### ③ Unit name plate insertion

Remove the protection sheet and insert the unit name plate at between the case and the reflector.

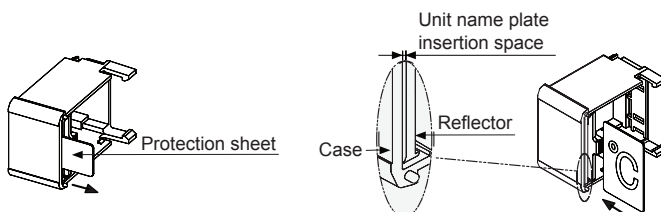

⚠ Caution: Be sure about the correct insert direction.

#### ● Model

Size	Color	Red	Green
16mm		DU16-R	DU16-G
22mm		DU22-R	DU22-G

# DS/DA Series

## ■ Dimensions

### ◎ DS16

(unit: mm)

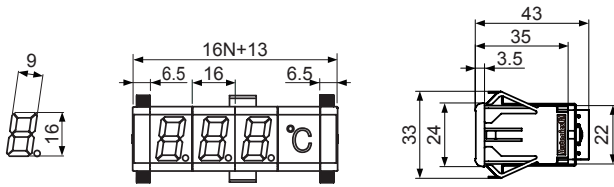

#### ● Panel cut-out

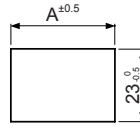

※N: Number of units  
※Panel thickness: 1.5 to 4mm

Units (N)	A (16N+11)
1	27
2	43
3	59
4	75
5	91
:	:

### ◎ DS22/DA22

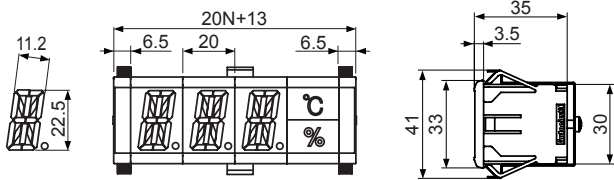

#### ● Panel cut-out

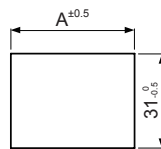

Units (N)	A (20N+11)
1	31
2	51
3	71
4	91
5	111
:	:

### ◎ DS40/DA40

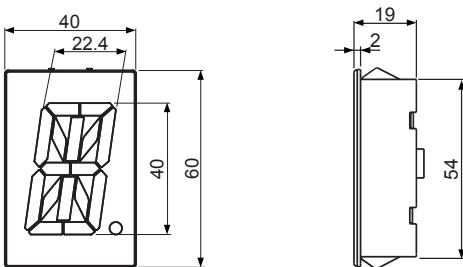

#### ● Panel cut-out

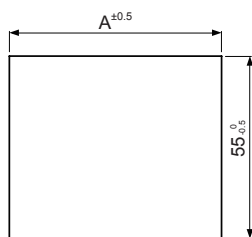

Units (N)	A (40N-2)
1	38
2	78
3	118
4	158
5	198
6	238
7	278
8	318
9	358
10	398
:	:

### ◎ DS60/DA60

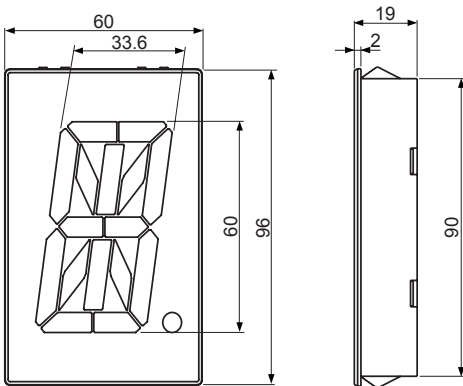

#### ● Panel cut-out

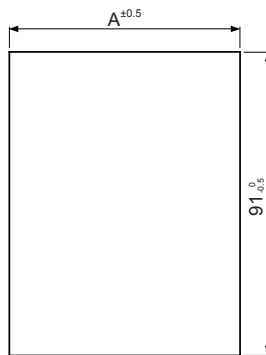

Units (N)	A (60N-3)
1	57
2	117
3	177
4	237
5	297
6	357
7	417
8	477
9	537
10	597
:	:



# Intelligent Display Unit

## ■ Accessories

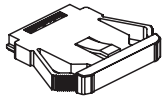

Cap for DS16/D22

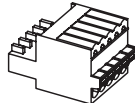

Connector for D22<sup>※1</sup>

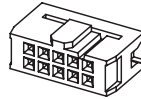

Connector for D□□-P

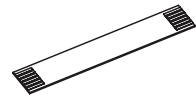

Ribbon cable (50mm) for D□40/D□60

※1: For parallel input model, use the connector for D□□-P.

## ■ Sold Separately

### ◎ Middle bracket

- BK-D16R (for DS16)

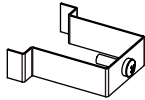

- BK-D22R (for D22)

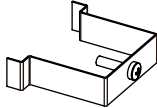

### ◎ Communication converter

- SCM-WF48 (Wi-Fi to RS485-USB wireless communication converter)



- SCM-US48I (USB to RS485 converter)



- SCM-38I (RS232C to RS485 converter)



## ■ Removing Protection Cover

To operate the function set switch of the D□40, D□60 models, you should remove the protection cover.  
Press the connection parts (4-point) of the protection cover at the top/bottom of the product with a flat-head screwdriver and the protection cover is removed.

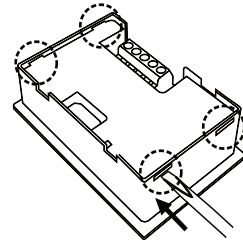

Flat-head screw driver

⚠Caution: Before removing the protection cover, power must be turned OFF.

## ■ Connection of Units

### ◎ DS16/D22

- Connect a basic unit, expansion units, a unit-display unit from the left and connect the caps the end of right and left.
- The middle bracket (sold separately) helps to protect deflection when connecting over 7 units. Use one middle bracket per 7 units.
- The basic unit supplies the power for expansion units and the unit-display unit and DATA input.

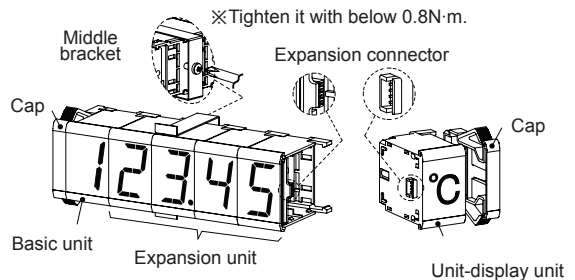

### ◎ D□40/D□60

Connect expansion connectors of units using a ribbon cable (accessory) as (figure 1).  
If the distance between expansion units is far as (figure 2), you can connect the cable at the soldering pad.  
**To use a soldering pad, remove the protection cover which only expansion units have.**

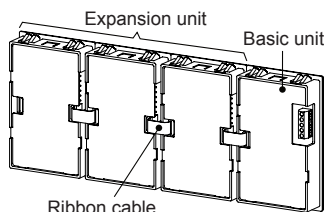

(figure 1)

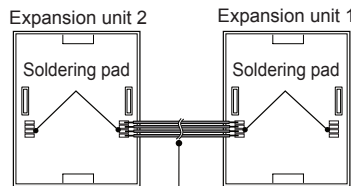

Cable length: max. 1m

(figure 2)

※You can use both the 7-segment display method model and the 16-segment display method model mixed.

# DS/DA Series

## Input Data Chart [Serial, Parallel, RS485 Comm.(Slave Mode) Input Model]

When selecting 5-bit data input for the serial input model, or 4-bit data input for the parallel input model, it displays only shaded part (0 to 9, A to F). If there is no input data after supplying the power, the basic unit differently displays by each input method; serial input model displays 'S', parallel input model displays 'P', and RS485 communication input model displays 'T'.

※In case of positive logic (PNP)

DS Series (7-segment)								DA Series (16-segment)								DU Series (unit)		Hi 2-bit / Low 4-bit			
D5	D4	D5	D4	D5	D4	D5	D4	D5	D4	D5	D4	D5	D4	D5	D4	D5	D4	D3	D2	D1	D0
L	L	L	H	H	L	H	H	L	L	L	H	H	L	H	H	X	X				
0	0	0	G	8	W	0	J	0	0	0	G	8	W	0	J	No unit		L	L	L	L
1	1	8	H	5	X	8		1	1	8	H	5	X	8	[	Upper-Lower OFF		L	L	L	H
2	2	0	I	8	Y	8		2	2	0	I	8	Y	8	+	Upper-Lower ON		L	L	H	L
3	3	0	J	8	Z	8		3	3	0	J	8	Z	8	:	Upper ON		L	L	H	H
4	4	8	K	8	-1	8	.	4	4	8	K	8	-1	8	;	Lower ON		L	H	L	L
5	5	8	L	8	(	8	W	5	5	8	L	8	(	8	<	Upper-Lower flashes		L	H	L	H
6	6	8	M	8	)	8	H(h)	6	6	8	M	8	)	8	>	Upper flashes		L	H	H	L
7	7	8	N	8	.	8	I	7	7	8	N	8	.	8		Lower flashes		L	H	H	H
8	8	8	O	8	"	8	J	8	8	8	O	8	"	8	!	※1		H	L	L	L
9	9	8	P	8	^	8	K	9	9	8	P	8	^	8	@			H	L	L	H
A	A	8	Q	8	.	8	K	A	A	8	Q	8	.	8	#			H	L	H	L
b	B	8	R	8	/	8	N	b	B	8	R	8	/	8	\$			H	L	H	H
c	C	8	S	8	?	8	O	c	C	8	S	8	?	8	%			H	H	L	L
d	D	8	T	8	-	8	T	d	D	8	T	8	-	8	&			H	H	L	H
e	E	8	U	8	_	8	X	e	E	8	U	8	_	8	*			H	H	H	L
F	F	8	V	8	=	Blank		F	F	8	V	8	=	Blank				H	H	H	H

※1: If this data is not for the unit-display unit, it maintains former state.

※The unit-display unit does not use the upper bit over D4. (don't care: X)

※Unit-display unit function

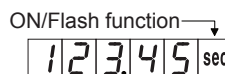
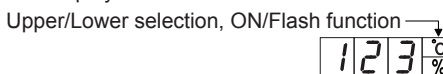

※It is only available to use the unit-display unit with serial 5-bit, parallel 4/6-bit Dynamic 1 input when connecting the unit display unit and turning ON it. (do not input data to the unit-display unit.)

※To display two data using zero blanking function

① Using the unit-display unit: If sending unit data signal after data 1 (00123), it applies zero blanking function when displaying data 2 (04567).

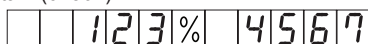

② Not using the unit-display unit: If sending no-unit data (HXXXLLLL) after data 1 (00123), it applies zero blanking function to display data 2. In this case, transmitted data should be added one to the display digits. (no-unit data is added)

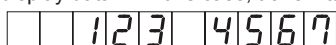

When do not using unit-display unit, no-unit data is used for data division. If it does not send no-unit data (HXXXLLLL), it displays data 1 (00123) and data 2 (04567) as one data. Zero-blanking function is applied to data 1 only.

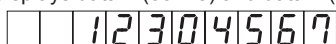

※Do not transfer unit data to basic/expansion unit. Unit bit (D7) of unit data is only for unit. If transferring unit data to basic/expansion unit, unit bit (D7) displays the ignored data value. In this case, Zero blanking does not operate normally.

## ■ Data Input Method [Serial, Parallel, RS485 Comm. Input Model]

### ◎ Serial input model

- 5-bit serial input (e.g.: displays 12.8°C)

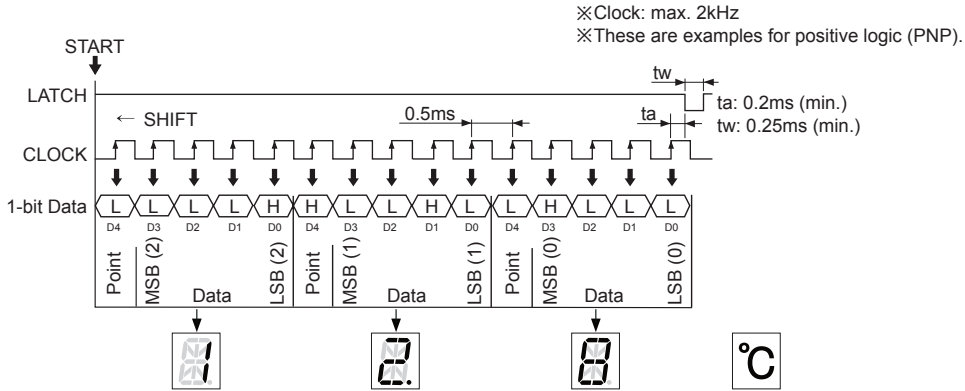

△ Caution: The unit-display unit is available only for turning ON. Do not input data to the unit-display unit.

- 8-bit serial input (e.g.: displays 25°C)

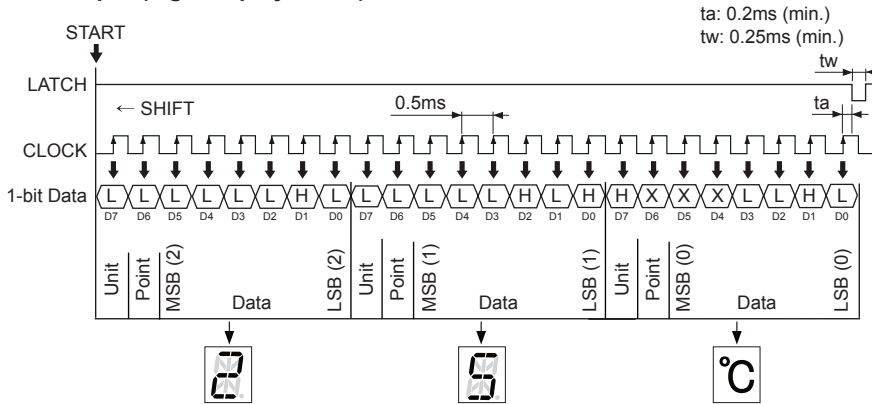

### ◎ Parallel input model

Example of unit organization by data input

Dynamic Parallel 1	4-bit	Connectable 1 basic unit and 5 expansion units (6-digit) E.g.) 10-digit organization: (1 basic unit + 5 expansion units)+ (1 basic unit + 3 expansion units)
	6-bit	Connectable 1 basic unit and 3 expansion units (4-digit) E.g.) 10-digit organization: (1 basic unit + 3 expansion units)×2+ (1 basic unit + 1 expansion units)
Dynamic Parallel 2	6-bit	Connectable 1 basic unit and 23 expansion units (24-digit) E.g.) 30-digit organization: (1 basic unit + 23 expansion units)+ (1 basic unit + 5 expansion units)

- 4-bit dynamic parallel 1 transmission (e.g.: displays ACE007.)

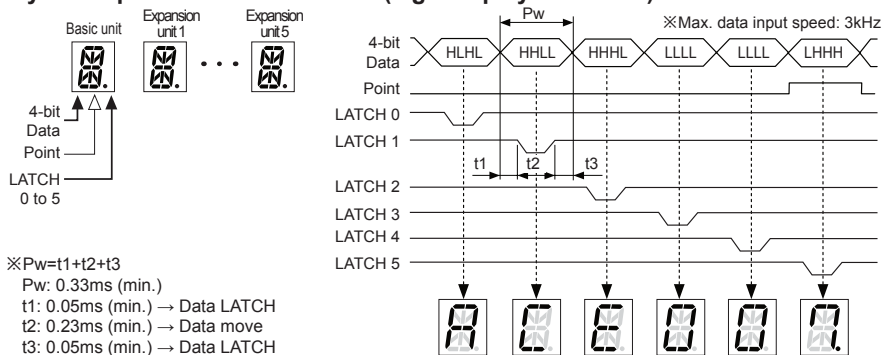

# DS/DA Series

## • 4-bit dynamic parallel 1 transmission (e.g.: displays 012345.6789)

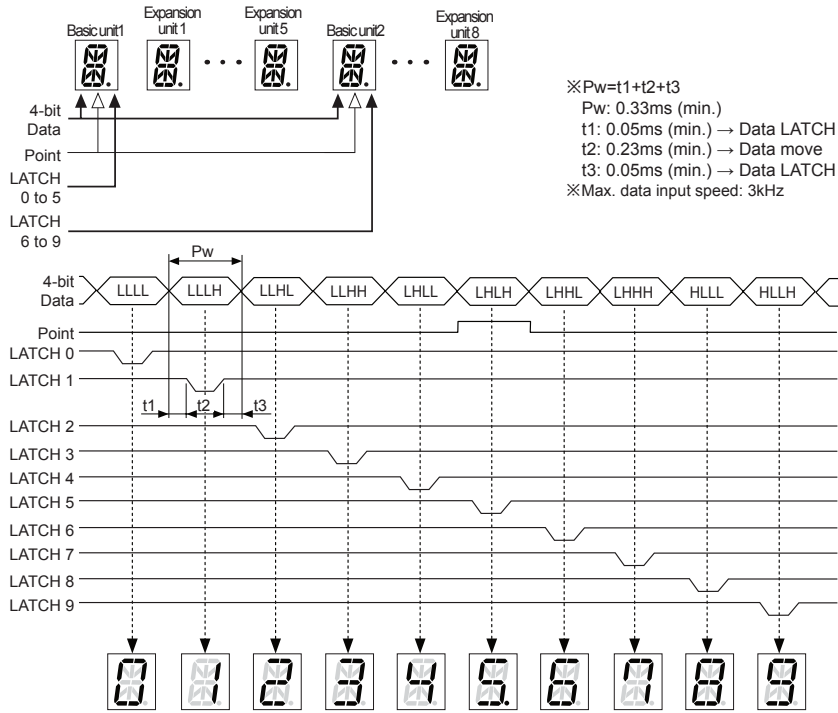

## • 6-bit dynamic parallel 1 transmission (e.g.: displays 50.80kg)

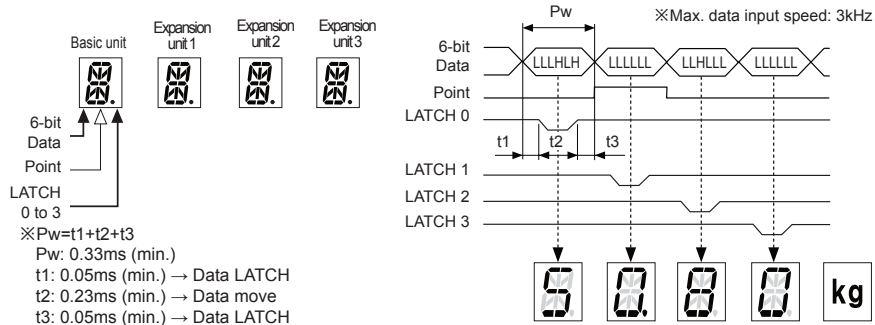

**⚠Caution: The unit-display unit is available only for turning ON. Do not input data to the unit-display unit.**

※General parallel input is only for basic unit (dynamic parallel 1).

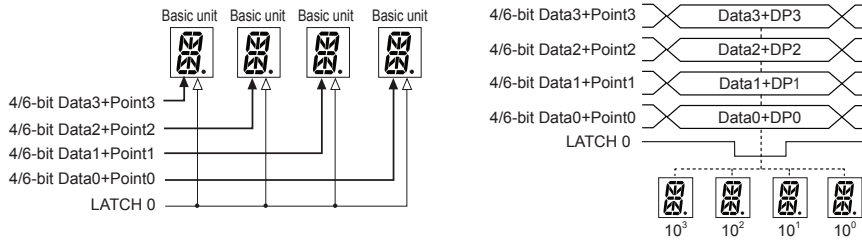

# Intelligent Display Unit

## • 6-bit dynamic parallel 1 transmission (e.g.: displays-AUTONICS-)

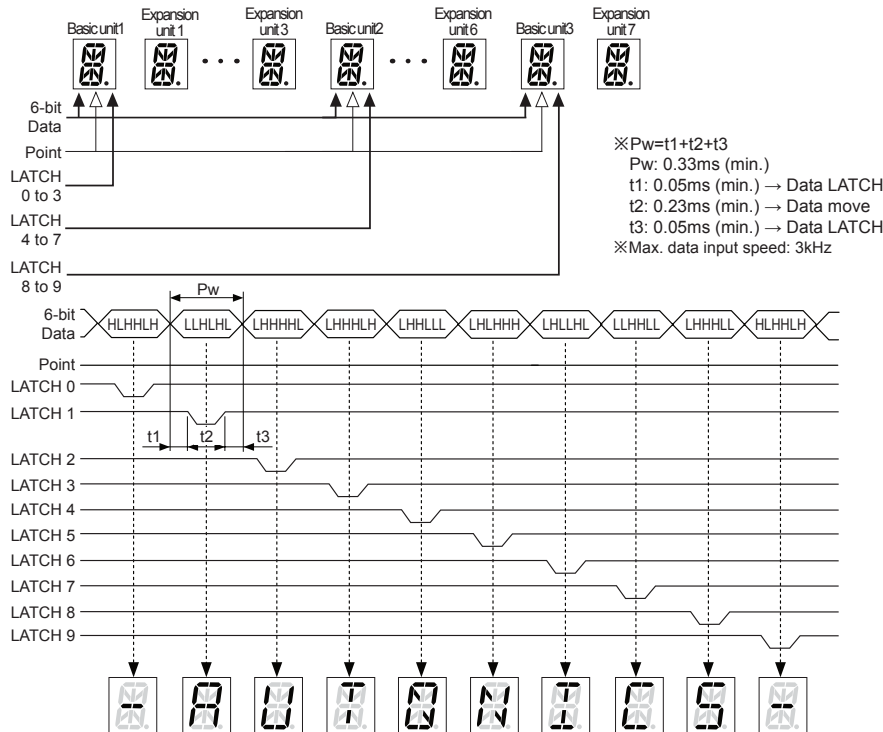

## • 6-bit dynamic parallel 2 transmission (e.g.: displays AB.C... W°F)

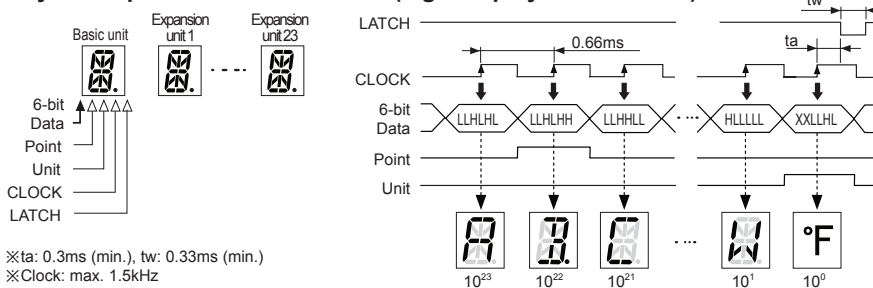

## © RS485 comm. (slave mode) input model

### • E.g.: Displays 10H38M (10 hour 38 min)

Communication address: 1, Communication speed: 9600bps, Data bit: 8-bit, Start/Stop bit: 1-bit, Parity bit: none

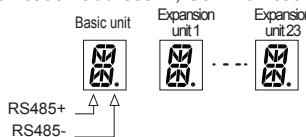

#### • Query (master)

Slave address	Function	Starting address		No. of Register	
		High	Low	High	Low
01H	10H	00H	00H	00H	04H

Byte Counter (No. of data byte)	Data (400001)		Data (400002)		Data (400003)		Data (400004)		Error check (CRC16)	
	High	Low	High	Low	High	Low	High	Low	Low	High
08H	00H	01H	01H	00H	11H	03H	08H	16H	D4H	59H

Zero Blanking ON



#### • Response (slave)

Slave Address	Function	Starting Address		No. of Register		Error Check (CRC16)	
		High	Low	High	Low	Low	High
01H	10H	00H	00H	00H	04H	C1H	CAH

# DS/DA Series

## ◎ RS485 comm. (master mode) input model

Connect the unit and the specified Autonics device which supports master mode for displaying current value without PC/PLC. The specified Autonics devices are connected by auto or manual setting.

### ● Supported Autonics device for RS485 master mode

Only for RS485 communication output model of the below series.

Item	Series
Temperature controller/sensor	TK, TX, TM2, TM4, THD
Counter/Timer	CT4, CT6
Pulse meter	MP5
Panel meter	MT4

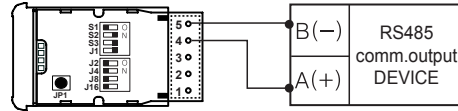

※Connect input terminal 4(A+) and 5(B-) of display unit to RS485 communication output terminal of the dedicated device.

## ■ Examples of Display

### ◎ RS485 communication input model

In case of manual connection setting, the highest digit may be not used.

#### 1) CT6 Series (using 6-digit)

1 2 3 . 4 5

#### 2) CT6 Series (using 5-digit)

1 2 3 . 4 5

#### 3) MP5 Series (using 5-digit)

- 1 2 . 3

#### 4) MP5 Series (using 4-digit)

- 1 2 . 3

#### 5) TM4 Series (4CH connection, using unit-display unit)

2 3 . 4 °C - 5 6 . 7 °C 1 2 3 . 4 °C 6 7 . 8 °C

#### 6) THD Series (using unit-display unit)

1 2 . 3 °C 5 2 . 7 %

### ◎ RS485 synchronous comm. type for time display model (delimiter for hour/min/sec)

Delimiter for hour/min/sec		Displaying 24-hour	Displaying 12-hour <sup>※1</sup>
Sign [:] (using 16 seg. expansion unit)	Hour/Min	0 0 : 3 0	P M 0 0 : 3 0
	Hour/Min/Sec	0 0 : 3 0 . 0 5	P M 0 0 : 3 0 . 0 5
Period [.] (using 7 seg. expansion unit)	Hour/Min	0 0 : 3 0	P M 0 0 : 3 0
	Hour/Min/Sec	0 0 : 3 0 . 0 5	P M 0 0 : 3 0 . 0 5

※Use 16-segment expansion unit for 'M' character for AM/PM when displaying 12 hours time.

### ◎ Pt temp. sensor input model

#### 1) Temperature (°C) display (displays DPt100Ω, 400.0°C)

4 0 0 . 0 °C



#### 2) Temperature (°F) display (JPt100Ω, 75.2°F)

7 5 . 2 °F



※Pt temp. sensor input model are applied Zero Blanking function automatically.

# Intelligent Display Unit

## Input Circuit

### Positive logic (PNP) input

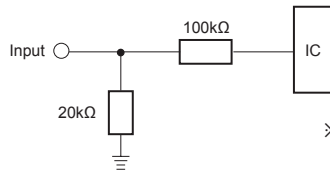

※Input level  
 High: 4.5-24VDC  
 Low: 0-1.2VDC

### Negative logic (NPN) input

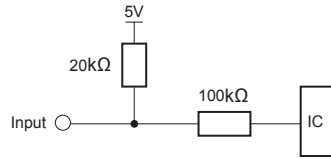

## World Time Zone [RS485 Synchronous Comm. Type for Time Display Model]

※Select the desired world time zone by function set switches (J1 to J16).

※If communication is not connected when supplying the power, the unit displays the set local time zone.

No.	Switch					Time Zone	Location
	J1	J2	J4	J8	J16		
0	0	0	0	0	0	UTC-12:00	International Date Line West
1	0	0	0	0	1	UTC-11:00	Coordinated Universal Time -11
2	0	0	0	1	0	UTC-10:00	Hawaii
3	0	0	0	1	1	UTC-09:00	Alaska
4	0	0	1	0	0	UTC-08:00	Pacific Time(US&Canada), Baja California
5	0	0	1	0	1	UTC-07:00	Mountain Time(US&Canada), Arizona, Chihuahua, La Paz, Mazatlan
6	0	0	1	1	0	UTC-06:00	Guadalajara, Mexico City, Monterrey, Saskatchewan, Central America, Central Time(US&Canada)
7	0	0	1	1	1	UTC-05:00	Eastern Time(US&Canada), Indiana(East), Bogota, Lima, Quito, Rio Branco, Chetumal
8	0	1	0	0	0	UTC-04:00	Atlantic Time(Canada), Asuncion, Georgetown, La Paz, Manaus, San Juan, Cuiaba
9	0	1	0	0	1	UTC-03:30	Newfoundland
10	0	1	0	1	0	UTC-03:00	Greenland, Montevideo, Buenos Aires, Brasilia, Santiago, Salvador, Cayenne, Fortaleza
11	0	1	0	1	1	UTC-02:00	Coordinated Universal Time -02
12	0	1	1	0	0	UTC-01:00	Cabo Verde Is., Azores
13	0	1	1	0	1	UTC 00:00	Coordinated Universal Time, Dublin, Edinburgh, Lisbon, London, Monrovia, Reykjavik, Casablanca
14	0	1	1	1	0	UTC+01:00	Belgrade, Bratislava, Budapest, Ljubljana, Prague, Brussels, Copenhagen, Madrid, Paris, Windhoek, Sarajevo, Skopje, Warsaw, Zagreb, West Central Africa, Amsterdam, Berlin, Bern, Rome, Stockholm, Vienna
15	0	1	1	1	1	UTC+02:00	Damascus, E.Europe, Beirut, Athens, Bucharest, Amman, Jerusalem, Istanbul, Cairo, Kaliningrad, Tripoli, Harare, Pretoria, Helsinki, Kyiv, Riga, Sofia, Tallinn, Vilnius
16	1	0	0	0	0	UTC+03:00	Nairobi, Moscow, St. Petersburg, Volgograd, Minsk, Baghdad, Kuwait, Riyadh
17	1	0	0	0	1	UTC+03:30	Tehran
18	1	0	0	1	0	UTC+04:00	Baku, Abu Dhabi, Muscat, Yerevan, Izhevsk, Samara, Tbilisi, Port Louis
19	1	0	0	1	1	UTC+04:30	Kabul
20	1	0	1	0	0	UTC+05:00	Ashgabat, Tashkent, Ekaterinburg, Islamabad, Karachi
21	1	0	1	0	1	UTC+05:30	Sri Jayawardenepura, Chennai, Kolkata, Mumbai, New Delhi
22	1	0	1	1	0	UTC+05:45	Kathmandu
23	1	0	1	1	1	UTC+06:00	Novosibirsk, Dhaka, Astana
24	1	1	0	0	0	UTC+06:30	Yangon(Rangoon)
25	1	1	0	0	1	UTC+07:00	Bangkok, Hanoi, Jakarta, Krasnoyarsk
26	1	1	0	1	0	UTC+08:00	Beijing, Chongqing, Hong Kong, Urumqi, Ulaanbaatar, Irkutsk, Kuala Lumpur, Singapore, Taipei, Perth
27	1	1	0	1	1	UTC+09:00	Seoul, Yakutsk, Osaka, Sapporo, Tokyo
28	1	1	1	0	0	UTC+09:30	Darwin, Adelaide
29	1	1	1	0	1	UTC+10:00	Guam, Port Moresby, Magadan, Brisbane, Vladivostok, Canberra, Melbourne, Sydney, Hobart
30	1	1	1	1	0	UTC+11:00	Solomon Is., New Caledonia, Chokurdakh
31	1	1	1	1	1	UTC+12:00	Coordinated Universal Time +12, Anadyr, Petropavlovsk-Kamchatsky, Auckland, Wellington, Fiji

# DS/DA Series

## ■ Comprehensive Device Management Program [DAQMaster]

- DAQMaster is comprehensive device management program for convenient management of parameters and multiple device data monitoring.
- Visit our website ([www.autonics.com](http://www.autonics.com)) to download user manual and comprehensive device management program.

< Computer specification for using software >

Item	Minimum requirements
System	IBM PC compatible computer with Intel Pentium III or above
Operations	Microsoft Windows 98/NT/XP/Vista/7/8/10
Memory	256MB+
Hard disk	1GB+ of available hard disk space
VGA	Resolution: 1024×768 or higher
Others	RS-232 serial port (9-pin), USB port

< DAQMaster screen >

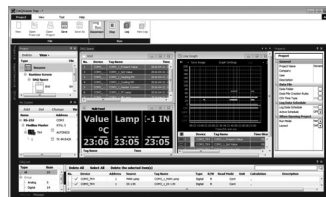

## ■ Device Synchronized Time Transfer Program [World Clock]

- World Clock is time synchronization program for RS485 synchronous comm. type DS□-C Series.
- Visit our website ([www.autonics.com](http://www.autonics.com)) to download user manual and device synchronized time transfer program.

< Computer specification for using software >

Item	Minimum requirements
System	IBM PC compatible computer with Intel Pentium III or above
Operations	Microsoft Windows 98/NT/XP/Vista/7/8/10
Memory	256MB+
Hard disk	1GB+ of available hard disk space
VGA	Resolution: 1024×768 or higher
Others	RS-232 serial port (9-pin), USB port

< World Clock screen >

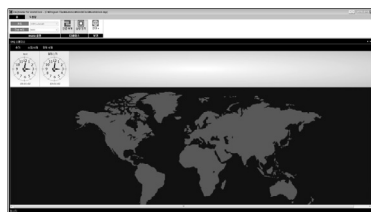

## ■ RS485 Communication Specifications

※ Only for RS485 communication input/output model.

Item	RS485 comm. input model (D□□□T)		RS485 synchronous comm. type for time display model (DS□□C)	RS485 comm. output model (DS□-RRT)
	Slave mode	Master mode		
Comm. protocol	Modbus RTU with 16-bit CRC			
Connection type	RS485			
Application standard	Compliance with EIA RS485			
Max. connection	31 units (address: 01 to 32)	1 unit (address: 01(fixed))	1 unit (address: 226 (fixed))	8 units (address: 01 to 08)
Comm. type	Two-wire half duplex			
Comm. distance	Max. 800m			
Comm. speed (bps)	4800, 9600, 19200, 38400		4800, 9600, 19200, 38400	9600, 38400
Comm. response time	5ms, 20ms	—	—	5ms (fixed)
Start bit	1-bit (fixed)			
Data bit	8-bit (fixed)			
Parity bit	None (fixed)			
Stop bit	1-bit (fixed)			



## ■ Communication Setting

### ◎ Application of system organization

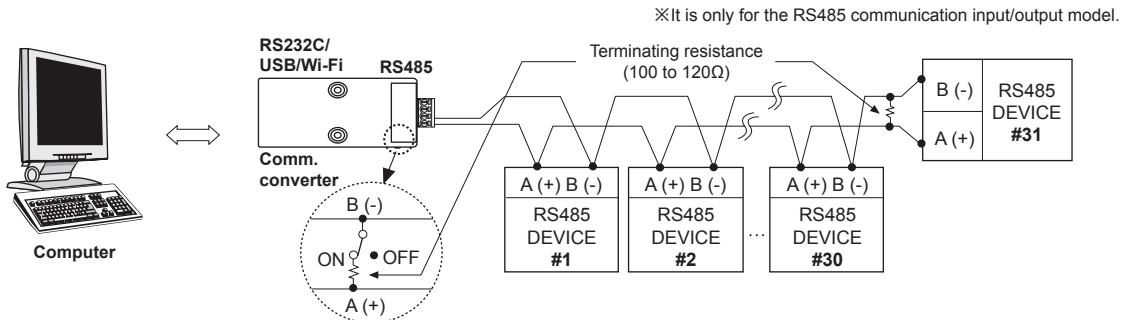

※It is recommended to use Autonics communication converter; SCM-WF48 (Wi-Fi to RS485-USB wireless communication converter, sold separately), SCM-US48I (USB to RS485 converter, sold separately), SCM-38I (RS232C to RS485 converter, sold separately). Please use twisted pair wire for RS485 communication.

### ◎ Modbus address mapping

#### ● Data format

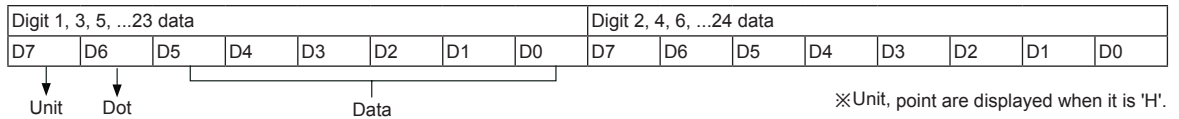

#### ● Product information

No. (Address)	Function	R/W	Parameter	Description	Factory default		Note	
					D□□□□T	DS□-RRT	D□□□□T	DS□-RRT
300001 to 300100	04	R	Reserved					
300101(0064)	04	R	---	Product number H	---			
300102(0065)	04	R	---	Product number L	---			
300103(0066)	04	R	---	Hardware version	---			
300104(0067)	04	R	---	Software version	---			
300105(0068)	04	R	---	Model name 1	'DS'			
300106(0069)	04	R	---	Model name 2	'(A'	'xx'		
300107(006A)	04	R	---	Model name 3	'x'	'-R'	DS(A)xx-xT	DSxx-RRT
300108(006B)	04	R	---	Model name 4	'x-'	'RT'		
300109(006C)	04	R	---	Model name 5	'xT'	0		
300110(006D) to 300114 (0071)	04	R	---	Model name 6 to 10	0			

※The below Series are automatically reconized RS485 master mode.

No. (Address)	Function	R/W	Parameter	Description	Factory default								Note
					CT Series	MP5 Series	MT4 Series	TK Series	TX Series	TM Series	THD Series		
300105(0068)	04	R	---	Model name 1	'CT'	'MP'	'MT'	'TK'	'TX'	'TM'	'TH'	Series name	
300106(0069)	04	R	---	Model name 2	'6M'	'5W'	'4W'	'4M'	'4'	'2'	'D'		
300107(006A)	04	R	---	Model name 3	'-2'	'-4'	'DV'	'14'	'S'	''	''		
300108(006B)	04	R	---	Model name 4	'PT'	'1X'	'-8'	'RR'	'14'	''	''		

#### ● Monitoring data

※Supports only Pt temp. input+RS485 comm. output model (DS□-RRT).

No. (Address)	Function	R/W	Parameter	Description	Factory default	Note
301001(03E8)	04	R	---	°C Temp. (-500 to 4000)	---	×10 data
301002(03E9)	04	R	---	°F Temp. (-580 to 7520)	---	×10 data
301003 to 301100	04	R	---	Reserved		

# DS/DA Series

## ● Display data (RS485 slave mode)

※Supports only when RS485 comm. input model (D□□-□T) uses slave mode.

No. (Address)	Function	R/W	Parameter	Parameter name	Description	Setting range	Factory default	
400001(0000)	03/06/16	R/W	—	Zero Blanking	Zero Blanking ON/OFF set	0: OFF, 1: ON	0	
400002(0001)	03/06/16	R/W	—	Digit 1, 2	1, 2 display data	Refer to Input data chart	0	
400003(0002)	03/06/16	R/W	—	Digit 3, 4	3, 4 display data		0	
400004(0003)	03/06/16	R/W	—	Digit 5, 6	5, 6 display data		0	
400005(0004)	03/06/16	R/W	—	Digit 7, 8	7, 8 display data		0	
400006(0005)	03/06/16	R/W	—	Digit 9, 10	9, 10 display data		0	
400007(0006)	03/06/16	R/W	—	Digit 11, 12	11, 12 display data		0	
400008(0007)	03/06/16	R/W	—	Digit 13, 14	13, 14 display data		0	
400009(0008)	03/06/16	R/W	—	Digit 15, 16	15, 16 display data		0	
400010(0009)	03/06/16	R/W	—	Digit 17, 18	17, 18 display data		0	
400011(000A)	03/06/16	R/W	—	Digit 19, 20	19, 20 display data		0	
400012(000B)	03/06/16	R/W	—	Digit 21, 22	21, 22 display data		0	
400013(000C)	03/06/16	R/W	—	Digit 23, 24	23, 24 display data		0	
400014 to 400050	03/06/16	R/W	Reserved					0

## ● Display data of RS485 master mode supporting device

When using RS485 comm. input model (D□□-□T) as master mode, it supports only for the Autonics device of supporting RS485 master mode.

### ※CT Series

No. (Address)	Function	R/W	Parameter	Description	Setting range	Note
301004(03EB)	04	R	—	Current value	Counter: 6-digit -99999 to 99999 / 4-digit -999 to 9999 Timer: within time range	—
301005(03EC)	04	R	—			
301006(03ED)	04	R	—	Decimal point	Counter: Decimal Point Timer: Timer Time_Range	—

### ※MP5 Series

No. (Address)	Function	R/W	Parameter	Description	Setting range	Note
301002(03E9)	04	R	—	Current value	-19999 to 99999: Normal display >99999: Flashes 99999 <-19999: Flashes 19999	—
301003(03EA)	04	R	—			
301004(03EB)	04	R	—	Decimal point	0: 00000, 1: 0000.0, 2: 000.00, 3: 00.000, 4: 0.0000	—

### ※MT4 Series

No. (Address)	Function	R/W	Parameter	Description	Setting range	Note
300001(0000)	04	R	—	Current value	5LRd: -5 to 110% 5LRl: -1999 to 9999 30000: HHHH, -30000: LLLL, 30001: d-HH, -30001: d-LL, 30002: F-HH	—
300002(0001)	04	R	—			

### ※TK/TX Series

No. (Address)	Function	R/W	Parameter	Description	Setting range	Note
301001(03E8)	04	R	—	Current value	-1999 to 9999	—
301002(03E9)	04	R	—	Decimal point	0: 0000, 1: 000.0, 2: 00.00, 3: 0.000	

### ※TM Series

No. (Address)	Function	R/W	Parameter	Description	Setting range	Note
301001(03E8)	04	R	—	CH1 Current value	-1999 to 9999	—
301002(03E9)	04	R	—	CH1 Decimal point	0: 0000, 1: 000.0	
301007(03EE)	04	R	—	CH2 Current value	-1999 to 9999	
301008(03EF)	04	R	—	CH2 Decimal point	0: 0000, 1: 000.0	
301013(03F4)	04	R	—	CH3 Current value	-1999 to 9999	
301014(03F5)	04	R	—	CH3 Decimal point	0: 0000, 1: 000.0	
301019(03FA)	04	R	—	CH4 Current value	-1999 to 9999	
301020(03FB)	04	R	—	CH4 Decimal point	0: 0000, 1: 000.0	

### ※THD Series

No. (Address)	Function	R/W	Parameter	Description	Setting range	Note
300001(0000)	04	R	—	Temperature value	-1990 to 6000	×100 data
300002(0001)	04	R	—	Humidity value	0 to 9990	×100 data

# Intelligent Display Unit

## ◎ Modbus address mapping

When using RS485 comm. input model (D□□-□□T) as master mode, it supports only for the Autonics devices of supporting RS485 master mode and **not using the upper digit**.

### ※CT6 Series (using 5-digit)

No. (Address)	Function	R/W	Parameter	Description	Setting range	Note
301004(03EB)	04	R	—	Current value	5 digit: -19999 to 99999	—
301005(03EC)	04	R	—			
301006(03ED)	04	R	—	Decimal point	Decimal point	—

### ※MP5 Series (using 4-digit)

No. (Address)	Function	R/W	Parameter	Description	Setting range	Note
301001(03E8)	04	R	—	Current value	4 digit: -1999 to 9999	—
301002(03E9)	04	R	—			
301003(03EA)	04	R	—	Decimal point	0: 0000, 1: 000.0, 2: 00.00, 3: 0.000	—

### ※MT4 Series (using 3-digit)

No. (Address)	Function	R/W	Parameter	Description	Setting range	Note
300001(0000)	04	R	—	Current value	3 digit: -199 to 999	—
300002(0001)	04	R	—	Decimal point	0: 000, 1: 00.0, 2: 0.00	—

### ※TK/TX Series (using 3-digit)

No. (Address)	Function	R/W	Parameter	Description	Setting range	Note
301001(03E8)	04	R	—	Current value	3 digit: -199 to 999	—
301002(03E9)	04	R	—	Decimal point	0: 000, 1: 00.0, 2: 0.00	—

## ● Time synchronized data

※Supports only when synchronous comm. type for time display model (DS□□□C).

No. (Address)	Function	R/W	Parameter	Description	Setting range	Note										
400001(0000)	0x90	W	—	UTC universal time	Hour (high byte), Min (low byte)	—										
400002(0001)	0x90	W	—		Sec (high byte), 1/100 sec (low byte)											
400003(0002)	0x90	W	—	Summer time	<ul style="list-style-type: none"> <li>Configuration: 1-byte (summer time setting) +1-byte (summer time setting)</li> <li>Summer time setting: local code (5-bit)+summer time (3-bit)</li> </ul> <table border="1"> <tr> <td>Summer time</td> <td>+30 min</td> <td>+1 hour</td> <td>-1 hour</td> <td>-30 min</td> </tr> <tr> <td>3-bit</td> <td>001 (1)</td> <td>010 (2)</td> <td>011 (3)</td> <td>100 (4)</td> </tr> </table> <ul style="list-style-type: none"> <li>Available up to max. 16 locals</li> <li>For displaying summer time, transfer the local data and summer time data also.</li> </ul> E.g.) Seoul +1 hour (0b01001010)		Summer time	+30 min	+1 hour	-1 hour	-30 min	3-bit	001 (1)	010 (2)	011 (3)	100 (4)
Summer time	+30 min	+1 hour	-1 hour				-30 min									
3-bit	001 (1)	010 (2)	011 (3)				100 (4)									
400004(0003)	0x90	W	—													
400005(0004)	0x90	W	—													
400006(0005)	0x90	W	—													
400007(0006)	0x90	W	—													
400008(0007)	0x90	W	—													
400009(0008)	0x90	W	—													
400010(0009)	0x90	W	—													



# Intelligent Display Unit

## ■ Communication Output

### ◎ Example of communication: displays "DA16" 4-digit

#### ● Communication setting

Communication address: 1 (J1-ON, J2-OFF, J3-OFF, J4-OFF, J8-OFF, J16-OFF)

Communication speed: 9600bps (S2-ON, S3-OFF)

Data bit: 8-bit (fixed)

Start/Stop bit: 1-bit (fixed)

Parity bit: none (fixed)

#### ● Query

Address	Function	Start address		No. of data		No. of byte	Data (400001)		Data (400002)		Data (400003)		Error Check (CRC16)	
		HI	LO	HI	LO		HI	LO	HI	LO	LO	HI		
01	10	00	00	00	03	06	00	01	0D	0A	01	06	78	7C

#### ● Response

Address	Function	Start address		No. of data		CRC16	
		HI	LO	HI	LO	LO	HI
01	10	00	00	00	03	80	08

## ■ PLC Example Program

### ◎ Parallel dynamic1 (4-bit) input method

① Display Unit DS/DA22-RP: 1, Display Unit DS/DA22-RE: 1

② Data input method: parallel dynamic 1 (4-bit)

③ Display result: "26°C" 3-digit display (flashes °C)

④ PLC: Autonics LP Series

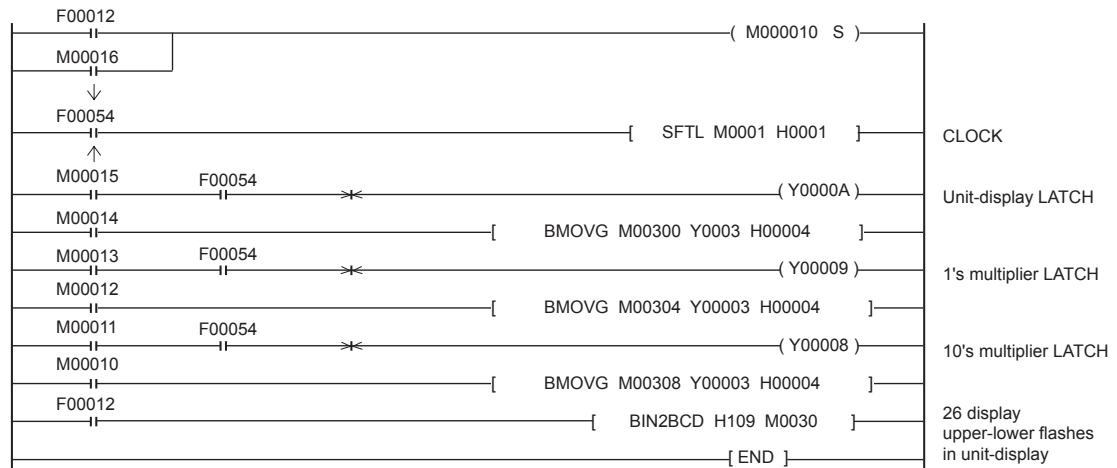

# DS/DA Series

## ◎ Serial (5-bit) input method

- ① Display Unit DS/DA22-RS:1, Display Unit DS/DA22-RE: 1
- ② Data input method: serial (5-bit)
- ③ Display result: "26°C" display (flashes °C)
- ④ PLC: Autonics, LP Series

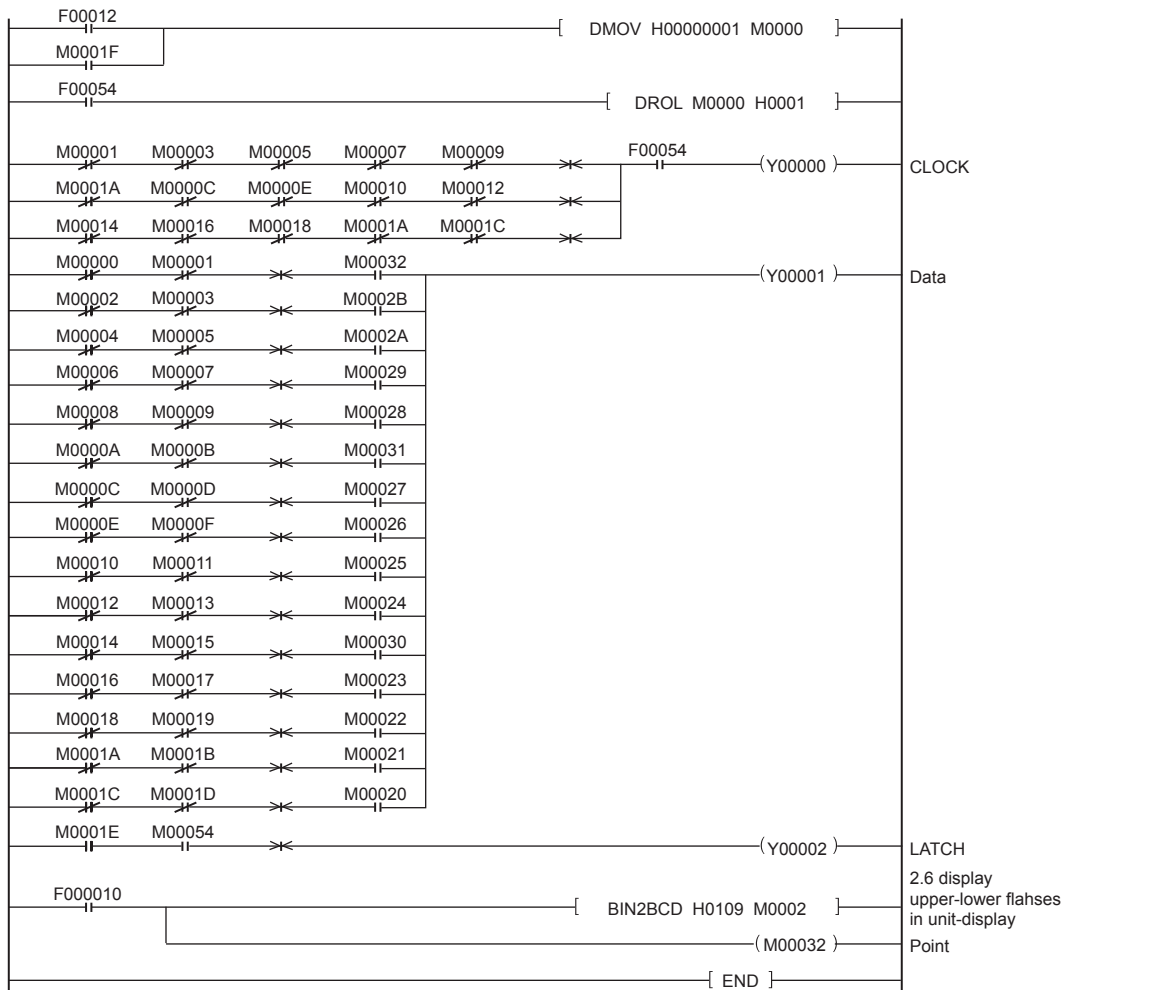

## ■ Cautions during Use

1. This unit must be mounted on the panel.
2. This is non-insulated product. Use insulated power for power supply.
3. For using Pt temp. sensor input model, you must wire 3-wire. To extend the wire, the thickness and length of 3 wires should be same. If the resistance are different, temperature error occurs.
4. For Pt temp. sensor input, if input value is out of the range, each display unit displays Error message. When it is under min. input value, a unit displays 'L'. When it is over max. input value, a unit displays 'H'.
5. For Pt temp. sensor input model, if Pt temp. sensor is not connected, it displays 'oP' (using 2 units)' or 'oPn' (using 3 units)'.
6. Input signal line
  - ① Shorten the cable distance between the external device and this product.
  - ② Use shield cable when input wiring is long.
  - ③ Wire the input signal line separately from the power line.
7. Dielectric or insulation resistance test when this unit is installed in the control panel.
  - ① Separate the unit from the control panel.
  - ② Short circuit all terminals of the unit.
8. Do not use this unit at below places.
  - ① Place where there are severe vibration or impact.
  - ② Place where strong alkalis or acids are used.
  - ③ Place where there are direct ray of the sun
  - ④ Place where strong magnetic field or electric noise are generated
9. This product may be used in the following environments.
  - ① Indoors
  - ② Max. altitude: 2,000m
  - ③ Pollution degree 2
  - ④ Installation category I