

# Absolute encoders - bus interfaces

Encoder with through hollow shaft max.  $\varnothing 70$  mm

Single and multiturn 13 bit ST / 12 or 16 bit MT

SSI / Profibus / CANopen® / DeviceNet

## HMG 161

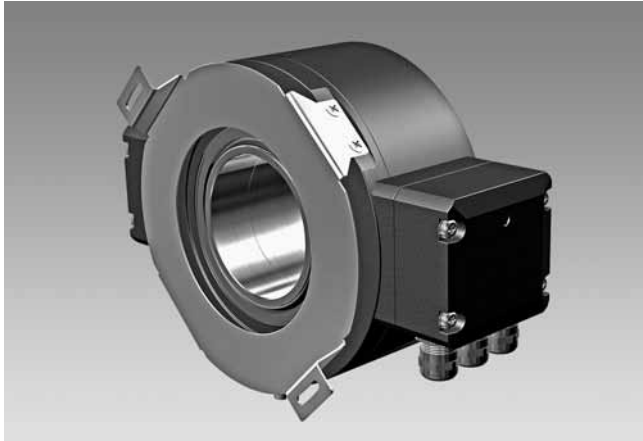

HMG 161

### Technical data - electrical ratings

Voltage supply	9...30 VDC
Consumption w/o load	≤100 mA (per interface SSI) ≤250 mA (per interface bus)
Initializing time	≤200 ms after power on
Interfaces	SSI, Profibus-DPV0, CANopen®, DeviceNet
Function	Multiturn
Transmission rate	9.6...12000 kBaud (Profibus) 10...1000 kBaud (CANopen®) 125...500 kBaud (DeviceNet)
Profile conformity	Profibus-DPV0 CANopen® CiA DSP 406 V 3.0 Device Profile Encoder V 1.0
Device address	Rotary switch in bus cover
Steps per turn	8192 / 13 bit
Number of turns	≤65536 / 16 bit
Additional output signals	Square-wave TTL (RS422) Square-wave HTL
Incremental output	2048 pulses per revolution
Sensing method	Optical
Code	Gray (version SSI)
Code sequence	CW default
Inputs	SSI clock (version SSI)
Interference immunity	EN 61000-6-2
Emitted interference	EN 61000-6-3
Programmable parameters	Depending on the selected absolute interface
Diagnostic function	Position or parameter error
Status indicator	DUO-LED integrated in bus cover
Approvals	CE, RoHS, UL approval / E256710

### Features

- Multiturn / SSI / Profibus / CANopen® / DeviceNet
- Optical sensing
- Singleturn 13 bit, multiturn 12 bit / 16 bit
- Through hollow shaft  $\varnothing 38...70$  mm
- Multiturn sensing with microGen technologie, without gear or battery
- Special protection against corrosion

### Optional

- Additional incremental output (TTL / HTL)
- Insulated bearing

### Technical data - mechanical design

Size (flange)	$\varnothing 160$ mm
Shaft type	$\varnothing 38...70$ mm (through hollow shaft)
Protection DIN EN 60529	IP 56
Operating speed	≤3500 rpm (mechanical)
Operating torque typ.	15 Ncm
Rotor moment of inertia	28.5 kgcm <sup>2</sup> ( $\varnothing 50$ )
Shaft loading	≤350 N axial ≤500 N radial
Materials	Housing: aluminium Shaft: stainless steel
Operating temperature	-20...+85 °C
Resistance	IEC 60068-2-6 Vibration 10 g, 10-2000 Hz IEC 60068-2-27 Shock 200 g, 6 ms
Explosion protection	II 3 G Ex nA IIC T4 Gc (gas) II 3 D Ex tc IIIB T135°C Dc (dust)
Weight approx.	3 kg (depending on version)
Connection	Bus cover Connecting terminal (SSI/ incremental)

# Absolute encoders - bus interfaces

Encoder with through hollow shaft max.  $\varnothing 70$  mm

Single and multiturn 13 bit ST / 12 or 16 bit MT

SSI / Profibus / CANopen® / DeviceNet

HMG 161

## Part number

HMG 161

Additional incremental signals  
Z0 Without  
T2048 TTL level, 2048 pulses  
H2048 HTL level, 2048 pulses

### Absolute share

13 13 bit singleturn  
25 13 bit singleturn + 12 bit multiturn  
(only S version)  
29 13 bit singleturn + 16 bit multiturn

### Interface/interfaces

S SSI  
P Profibus  
C CANopen®  
D DeviceNet

## Accessories

### Connectors and cables

HEK 8 Sensor cable for encoders

### Diagnostic accessories

HENQ 1100 Analyzer for encoders

# Absolute encoders - bus interfaces

Encoder with through hollow shaft max.  $\varnothing 70$  mm

Single and multiturn 13 bit ST / 12 or 16 bit MT

SSI / Profibus / CANopen® / DeviceNet

## HMG 161

### Terminal assignment - Profibus

View A - Connecting terminal in cover

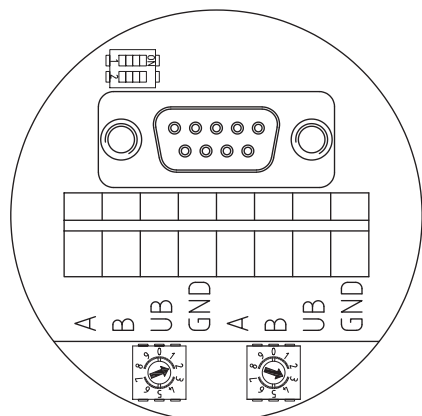

### Terminal assignment - CANopen®

View A - Connecting terminal in cover

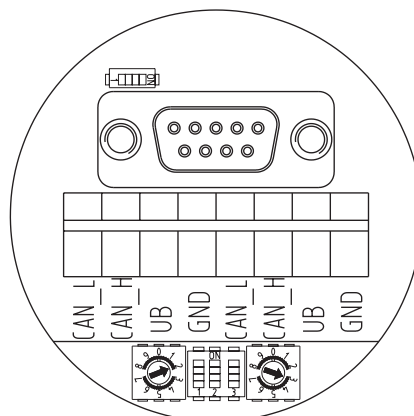

### Terminal significance - Profibus

A	Negative serial data transmission, pair 1 and pair 2
B	Positive serial data transmission, pair 1 and pair 2
UB	Voltage supply 9...30 VDC
GND	Ground connection for UB

Terminals with the same label are internally connected.

### Terminal significance - CANopen®

CAN_L	CAN Bus signal (dominant low)
CAN_H	CAN Bus signal (dominant high)
UB	Voltage supply 9...30 VDC
GND	Ground connection for UB

Terminals with the same label are internally connected.

### Features - Profibus

Protocol	Profibus DP V0
Profibus features	Device Class 1 and 2
Data Exch. functions	Input: Position value Output: Preset value
Preset value	The „Preset“ parameter can be used to set the encoder to a predefined value that corresponds to a specific axis position of the system.
Parameter functions	Rotating direction: The relationship between the rotating direction and rising or falling output code values can be set in the operating parameter. Scaling: The parameter values set the number of steps per turn and the overall resolution.
Diagnostic	The encoder supports the following error messages: - Position error
Default settings	User address 00

### Features - CANopen®

Protocol	CANopen®
CANopen® features	Device class 2 CAN 2.0B
Device profile	CANopen® CiA DSP 406, V 3.0
Operation modes	Polling mode (asynch, via SDO) Cyclic mode (asynch-cyclic) Synch mode (synch-cyclic) Acyclic mode (synch-acyclic)
Diagnostic	The encoder supports the following error messages: - Position error
Default settings	User address 00

# Absolute encoders - bus interfaces

Encoder with through hollow shaft max.  $\varnothing 70$  mm

Single and multiturn 13 bit ST / 12 or 16 bit MT

SSI / Profibus / CANopen® / DeviceNet

HMG 161

## Terminal assignment - DeviceNet

**View A** - Connecting terminal in cover

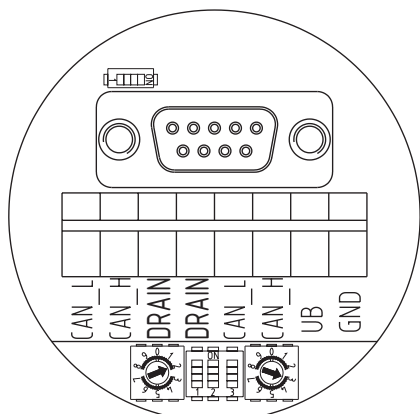

## Terminal significance - DeviceNet

CAN\_L CAN bus Signal (dominant Low)

CAN\_H CAN bus Signal (dominant High)

DRAIN Shield connection

UB Voltage supply 9...30 VDC

GND Ground connection relating to UB

Terminals of the same significance are internally connected and identical in their functions. Max. load on the internal terminal connections UB-UB and GND-GND is 1 A each.

## Features - DeviceNet

Protocol DeviceNet

DeviceNet features Device Profile for Encoders V 1.0

Operating modes I/O-Polling  
Cyclic  
Change of State

Preset value The „Preset“ parameter can be used to set the encoder to a predefined value that corresponds to a specific axis position of the system. The offset of encoder zero point and mechanical zero point is stored in the encoder.

Parameter functions Rotating direction:  
The relationship between the rotating direction and rising or falling output code values can be set in the operating parameter.  
Scaling:  
The parameter values set the number of steps per turn and the overall resolution.

Diagnostic The encoder supports the following error warnings:  
- Position and parameter error

Default settings User address 00

## Terminal assignment - Incremental and/or SSI

**View B** - Connecting terminal

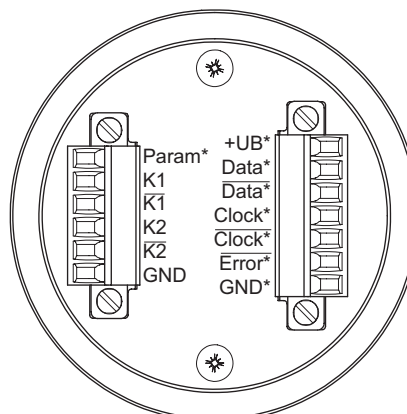

\* only for SSI

**View C** - Option

Flange connector M23, 12-pin, male contacts, counter-clockwise

Male Assignment

Pin 1  $\overline{K2}$

Pin 2 Clock \*

Pin 3 Data \*

Pin 4  $\overline{Data}$  \*

Pin 5 K1

Pin 6  $\overline{K1}$

Pin 7 Param \*

Pin 8 K2

Pin 9  $\overline{Error}$  \*

Pin 10 GND

Pin 11  $\overline{Clock}$  \*

Pin 12 +UB \*

\* only for SSI

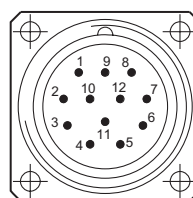

# Absolute encoders - bus interfaces

Encoder with through hollow shaft max.  $\varnothing 70$  mm

Single and multiturn 13 bit ST / 12 or 16 bit MT

SSI / Profibus / CANopen® / DeviceNet

## HMG 161

### Data transfer

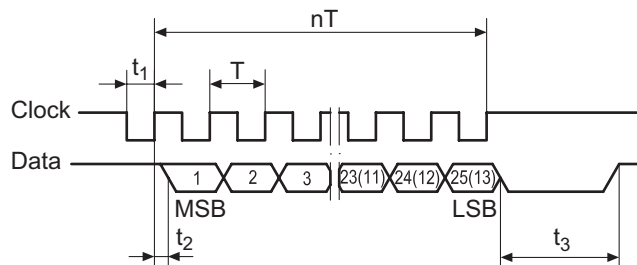

$$T = 1.25 \dots 10 \mu\text{s}$$

$$t_1 = 0.63 \dots 5 \mu\text{s}$$

$$t_2 \leq 0.4 \mu\text{s}$$

$$t_3 = 12 \dots 30 \mu\text{s}$$

$$n = \text{Number of bits}$$

$$\text{Clock frequency} = 100 \dots 800 \text{ kHz}$$

### Output signals

Additional incremental signals  
at positive rotating direction

