



Operating instructions
Flow sensors

SAxx04
SAxx14

UK

80261065 / 00 05 / 2018

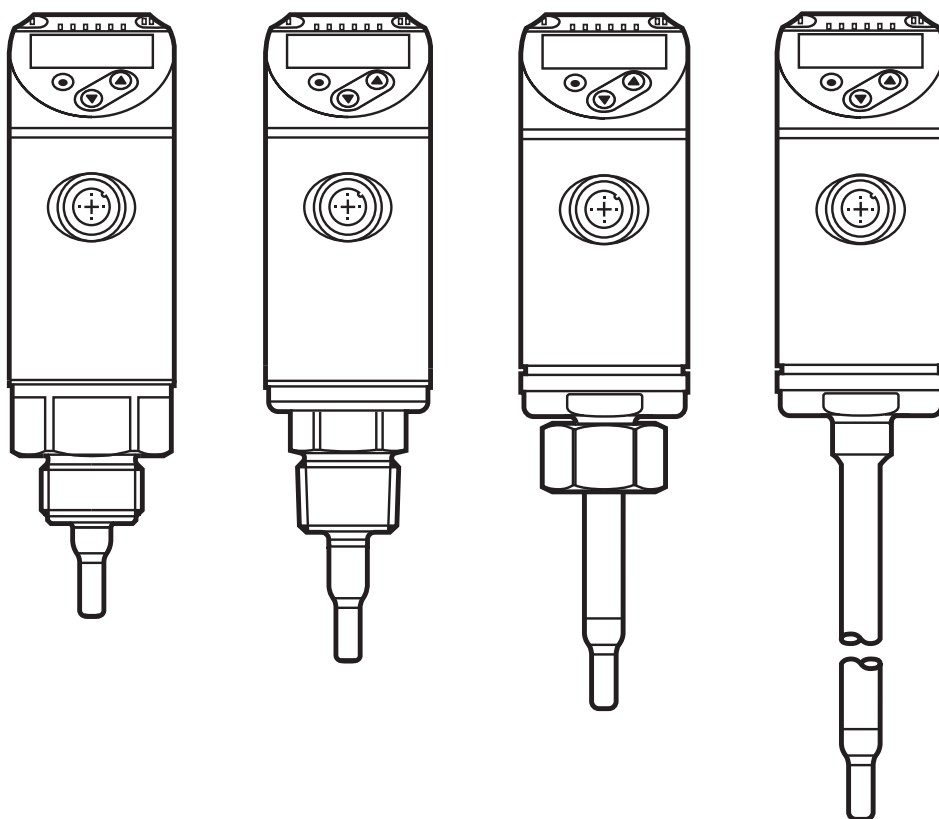

Contents

1 Preliminary note.....	3
2 Safety instructions	4
3 Functions and features	4
4 Function.....	5
4.1 Operating modes (ModE)	5
4.2 Select medium (MEdl)	6
4.3 Define the internal pipe diameter (diA)	6
4.4 Customer-specific calibration (CGA)	6
4.5 Analogue function	7
4.6 Measured value damping (dAP)	8
4.7 IO-Link	9
5 Mounting	9
5.1 Installation position	10
5.2 Interference in the pipe system	12
5.3 Alignment	12
6 Electrical connection.....	13
7 Operating and display elements	14
8 Menu	15
9 Set-up	17
10 Parameter setting	18
10.1 Parameter setting in general	18
10.1.1 Switch between the menus.....	19
10.1.2 Change to the process value display (RUN mode)	19
10.1.3 Lock / unlock.....	19
10.1.4 Timeout.....	19
10.2 Settings for volumetric flow monitoring.....	20
10.2.1 Define the operating mode	20
10.2.2 Define the internal pipe diameter.....	20
10.2.3 Configure the analogue output for flow (OUT2).....	21
10.2.4 Carry out the flow adjustment.....	21
10.3 Settings for temperature monitoring	22
10.3.1 Analogue output for temperature (OUT1).....	22

10.4	User settings (optional).....	22
10.4.1	Configure standard display.....	22
10.4.2	Set the standard unit of measurement for flow.....	22
10.4.3	Select the medium.....	22
10.4.4	Define colour of the display	23
10.4.5	Set the measured value damping.....	23
10.4.6	Set output status in fault condition.....	23
10.4.7	Calibrate curve of measured values	23
10.5	Service functions	24
10.5.1	Read min/max values	24
10.5.2	Reset all parameters to factory setting.....	24
11	Operation	24
11.1	Read the process value	24
11.2	Read the set parameters	25
12	Technical data.....	25
13	Fault correction.....	25
14	Maintenance	26
15	Factory setting	27

UK

1 Preliminary note

Technical data, approvals, accessories and further information at www.ifm.com.

- ▶ Instructions
- > Reaction, result
- [...] Designation of keys, buttons or indications
- Cross-reference



Important note

Non-compliance may result in malfunction or interference.



Information

Supplementary note.

CAUTION

Warning of personal injury.
Slight reversible injuries may result.

2 Safety instructions

- Read this document before setting up the product and keep it during the entire service life.
- The product must be suitable for the corresponding applications and environmental conditions without any restrictions.
- Only use the product for its intended purpose (→ 3 Functions and features).
- Only use the product for permissible media (→ 12 Technical data).
- If the operating instructions or the technical data are not adhered to, personal injury and/or damage to property may occur.
- The manufacturer assumes no liability or warranty for any consequences caused by tampering with the product or incorrect use by the operator.
- Installation, electrical connection, set-up, operation and maintenance of the unit must be carried out by qualified personnel authorised by the machine operator.
- Protect units and cables against damage.

3 Functions and features

The unit monitors liquids and gases. It detects the process categories flow and medium temperature.

Application area

- Air
- Water
- Glycol solutions (reference medium: 35 % ethylene glycol solution)
- Low-viscosity oils (viscosity: $\leq 40 \text{ mm}^2/\text{s}$ at $40 \text{ }^\circ\text{C}$ / $\leq 40 \text{ cSt}$ at $104 \text{ }^\circ\text{F}$)
- High-viscosity oils (viscosity: $\geq 40 \text{ mm}^2/\text{s}$ at $40 \text{ }^\circ\text{C}$ / $\geq 40 \text{ cSt}$ at $104 \text{ }^\circ\text{F}$)

Selection of the medium to be monitored → 10.4.3.



This is a class A product.

The unit may cause radio interference in domestic areas.

- ▶ If required, take appropriate EMC screening measures.

4 Function

- The unit detects flow based on the calorimetric measuring principle.
- The unit also detects the medium temperature.
- It features an IO-Link interface for parameter setting.
- The unit displays the current process value.

It generates 2 output signals according to the parameter setting:



OUT1: Parameter setting
- Analogue signal for temperature → 10.3.1
- IO-Link interface for parameter setting → 4.7

OUT2: Parameter setting
- Analogue signal for flow → 10.2.3

4.1 Operating modes (ModE)

The unit provides three selectable operating modes for flow measurement:

Operating mode	Medium	Display unit
REL	liquids, air	% (of the taught range → 10.2.4)
LIQU	liquids	m/s, l/min, m ³ /h (fps, gpm, cfm)
GAS	air	m/s, l/min, m ³ /h (fps, gpm, cfm)

-  The selected operating mode has no effect on the temperature measurement, only absolute values in °C or °F are indicated.
-  The parameter settings are saved in the respective operating mode, i.e. when the operating mode is changed, the settings are not lost.
-  If the operating modes LIQU and GAS are selected:
 - ▶ Define the medium and the internal pipe diameter (→ 10.2.1).
 - ▶ If required, calibrate curve of measured values (→ 10.4.7).

4.2 Select medium (MEdl)

The unit has characteristic curves for different media. Depending on the operating mode, the following media can be selected in the menu (→ 10.4.3):

Medium	Operating mode		
	REL	LIQU	GAS
H2O	X	X	
OIL1*	X	X	
OIL2**	X	X	
GLYC	X	X	
AIR	X		X

*OIL1:

Viscosity $\geq 40 \text{ mm}^2/\text{s}$ at $40 \text{ }^\circ\text{C}$ / $\geq 40 \text{ cSt}$ at $104 \text{ }^\circ\text{F}$

**OIL2:

Viscosity $\leq 40 \text{ mm}^2/\text{s}$ at $40 \text{ }^\circ\text{C}$ / $\leq 40 \text{ cSt}$ at $104 \text{ }^\circ\text{F}$

4.3 Define the internal pipe diameter (diA)

In the operating modes LIQU and GAS the internal pipe diameter has to be entered to define the volumetric flow (→ 10.2.2).

4.4 Customer-specific calibration (CGA)

Via the calibration factor CGA the sensor can be adjusted to a reference flow in the application.

The customer-specific calibration allows changing the gradient of the curve of measured values. It influences the display and the outputs.

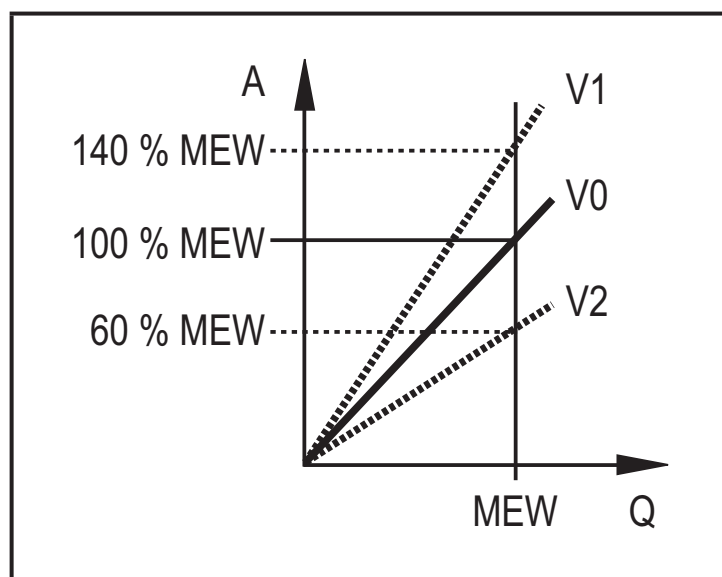

A = Operating value for display and output signals

Q = Flow

MEW = Final value of the measuring range

V0 = Curve of measured values at factory setting

V1, V2 = Curve of measured values after calibration

The change in the gradient is indicated in percentage.

Factory setting: CGA = 100 %.

After a change the calibration can be reset to factory setting (→ 10.5.2).



Depending on the set CGA factor, it may not be possible to use the complete measuring range.

4.5 Analogue function

The unit provides an analogue signals that are proportional to the flow quantity and the medium temperature.

Within the measuring range the analogue signal is 4...20 mA.

The measuring range is scalable:

- [ASP] determines at which measured value the output signal is 4 mA.
- [AEP] determines at which measured value the output signal is 20 mA.



Minimum distance between [ASP] and [AEP] = 20 % of the final value of the measuring range.



For flow measurement in the operating mode [ModE] = REL, [ASP2] and [AEP2] are not available. In this operating mode, the characteristic curve of the analogue output is defined by the flow adjustment:
high flow = 20 mA; low flow = 4 mA.

If the measured value is outside the measuring range or in the event of an internal error, the current signals indicated in figure 1 are provided.

For measured values outside the display range or in case of a fault, messages are displayed (UL, OL, Err; → 13).

The analogue signal in case of a fault is adjustable (→ 10.4.6):

- [FOU] = On determines that the analogue signal goes to the upper final value (22 mA) in case of an error.
- [FOU] = OFF determines that the analogue signal goes to the lower final value (3.5 mA) in case of an error.

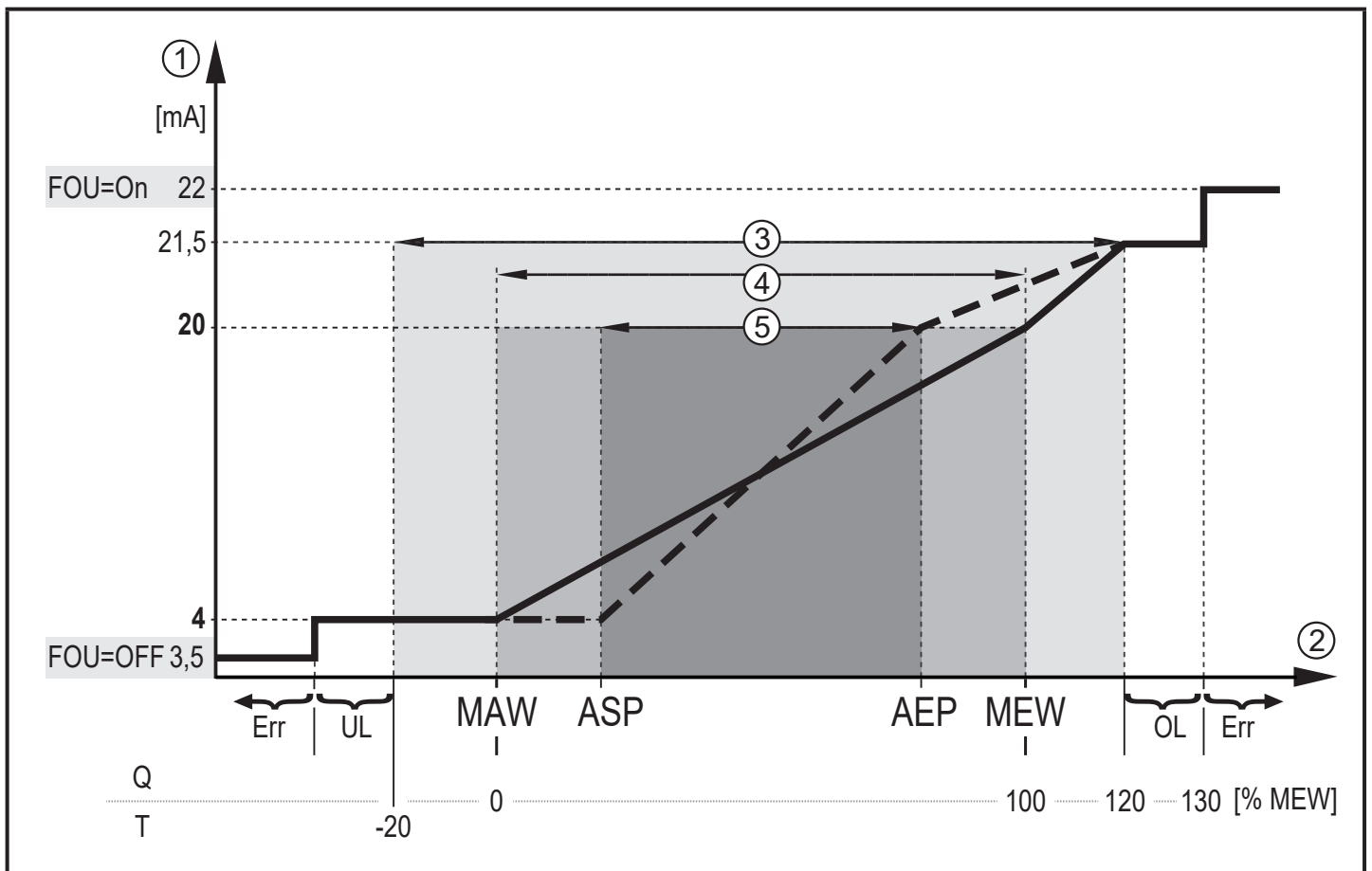

Figure 1: Characteristics of the analogue output according to the standard IEC 60947-5-7.

Q: Volumetric flow

T: Medium temperature

MAW: Initial value of the measuring range for non-scaled measuring range

MEW: Final value of the measuring range for non-scaled measuring range

ASP: Analogue start point with scaled measuring range

AEP: Analogue end point with scaled measuring range

UL: Below the display range

OL: Above the display range

Err: The unit is in the error state

① Analogue signal

② Measured value (flow or temperature)

③ Display range

④ Measuring range

⑤ Scaled measuring range

4.6 Measured value damping (dAP)

The damping time enables to set after how many seconds the output signal has reached 63 % of the final value if the flow value changes suddenly. The set damping time stabilises the outputs, the display and the process value transfer via the IO-Link interface. The signals [UL] and [OL] (→ 13 Fault correction) are defined under consideration of the damping time.

4.7 IO-Link

This unit has an IO-Link communication interface for parameter setting.

With a PC, suitable IO-Link software and an IO-Link adapter cable communication is possible when the system is not in operation.

The IO-DDs necessary for the configuration of the unit, detailed information about process data structure, diagnostic information, parameter addresses and the necessary information about the required IO-Link hardware and software can be found at www.ifm.com.

5 Mounting

UK

CAUTION

For medium temperatures above 50 °C (122 °F) some parts of the housing can heat up to over 65 °C (149 °F).

- > Risk of burns.
- ▶ Protect the housing against contact with flammable substances and unintentional contact.



- ▶ Ensure that the system is free of pressure during installation.
- ▶ Ensure that no media can leak at the mounting location during installation.

Using process adapters the unit can be adapted to different process connections. Adapters have to be ordered separately as accessories.

- Information about the available mounting accessories at www.ifm.com.
- A correct fit of the unit and ingress resistance of the connection are only ensured using ifm adapters.



- ▶ Observe the instructions of the mounting accessories.
- ▶ Use a lubricating paste which is suitable and approved for the application. Grease the threads of the process connection, adapter and sensor. Ensure no grease is applied to the sensor tip.



- ▶ Take the tightening torques of sensor and fixing elements into account. The following tightening torques apply to ifm sensors:
Types M18 x 1.5 and G1/2: 25 Nm
Types 1/2" NPT: 100 Nm

5.1 Installation position

General

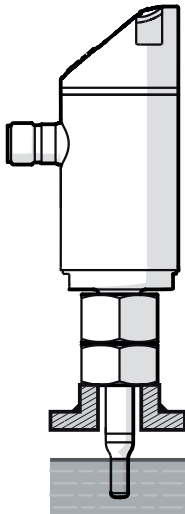

The sensor tip must be completely surrounded by the medium.

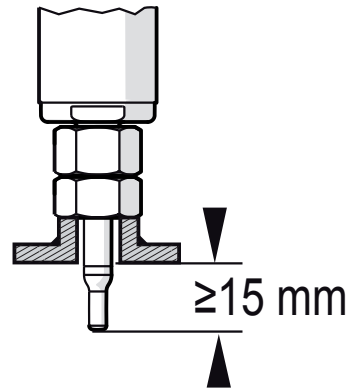

Internal pipe diameter (diA)	Immersion depth
< 120 mm	~ 15 mm
≥ 120 mm	~ 1/8 diA

Table 1: Immersion depth of the probe



For strong leverage on the measuring probe, e.g. due to high-viscosity or strongly flowing media:

- ▶ Do not exceed the immersion depth indicated in table 1.

Recommended

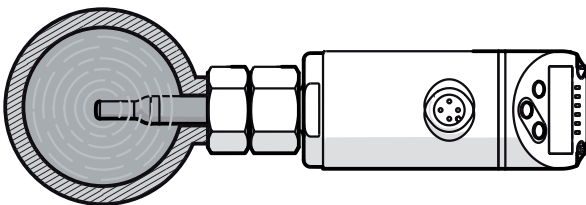

For horizontal pipes:
mounting from the side.

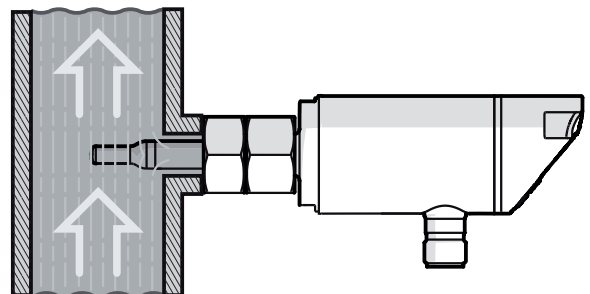

For vertical pipes:
mounting in the rising pipe.

Conditionally possible

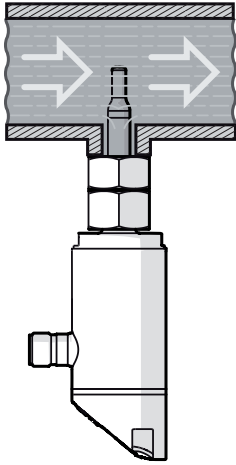

Horizontal pipe /mounting from the bottom:
if the pipe is free from build-up.

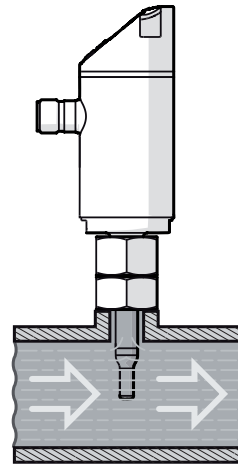

Horizontal pipe /mounting from the top: if
the pipe is completely filled with medium.

UK

Not allowed

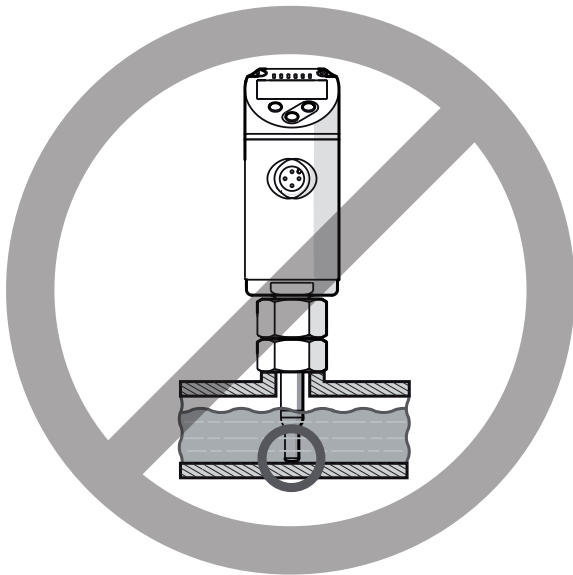

The sensor tip must not be in contact with
the pipe wall.

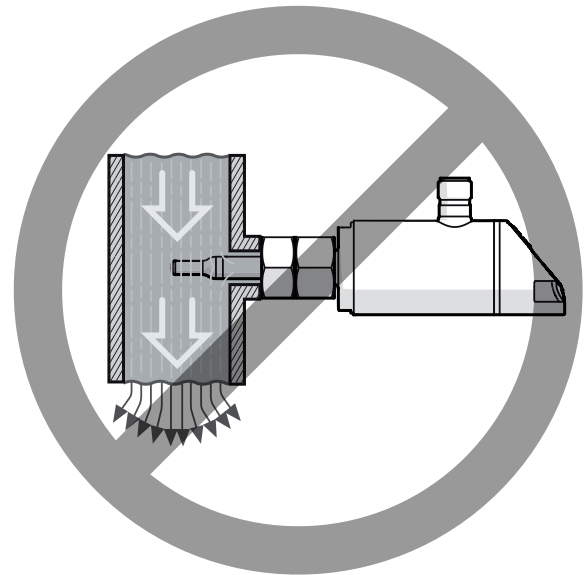

Do not mount in downpipes that are open
at the bottom.

5.2 Interference in the pipe system

Components integrated in the pipes, bends, valves, reductions, etc. lead to turbulence of the medium. This affects the function of the unit.

► Adhere to the distances between sensor and sources of interference:

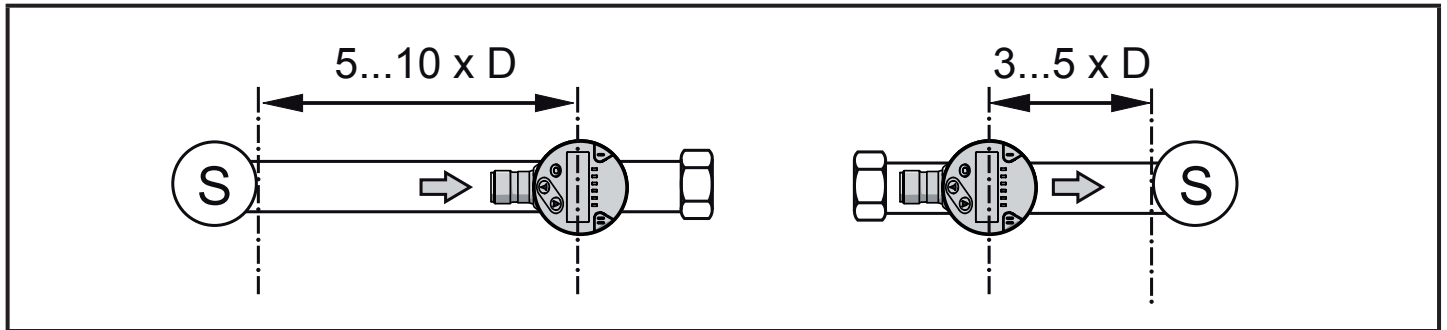

D = pipe diameter; S = sources of interference

5.3 Alignment

► To achieve the optimum measuring accuracy: mount the sensor in a way that the flow goes to the larger of the two key surfaces (1).

 On units with an external thread, a bore hole in the key surface (2) indicates the flow direction.

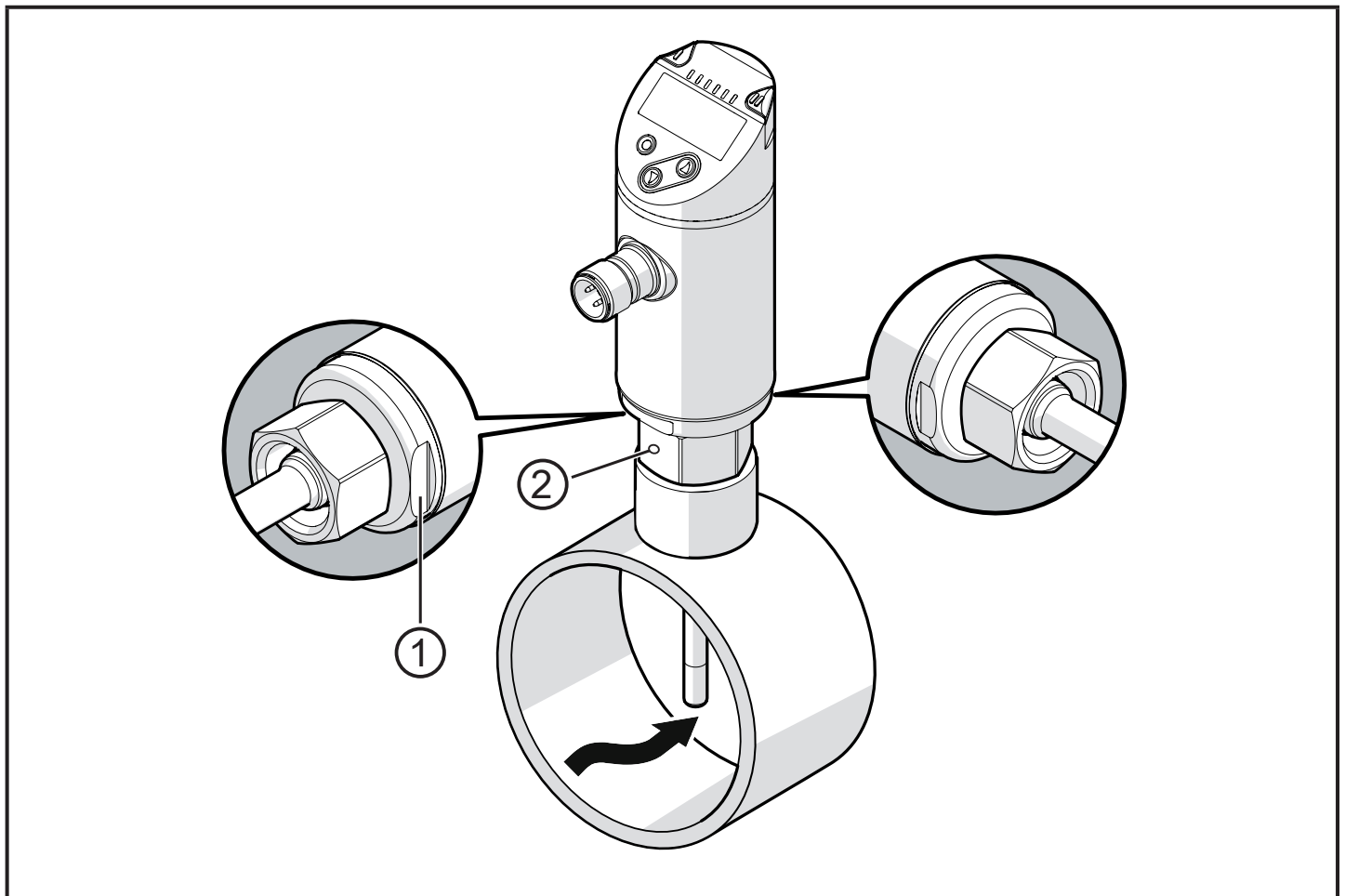

For easier readability of the display the sensor housing can be rotated by 345° with regard to the process connection.



Do not go beyond the end stop.

6 Electrical connection



The unit must be connected by a qualified electrician.

The national and international regulations for the installation of electrical equipment must be adhered to.

Voltage supply according to EN 50178, SELV, PELV.

UK

- ▶ Disconnect power.
- ▶ Connect the unit as follows:

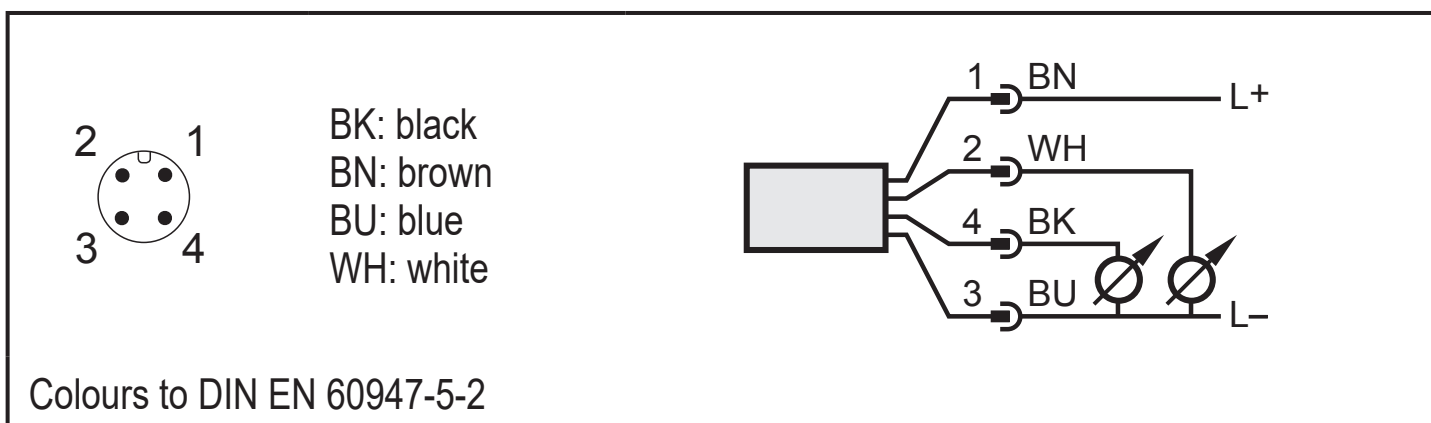

Pin 1	L+
Pin 3	L-
Pin 4 (OUT1)	<ul style="list-style-type: none"> • Analogue signal for temperature • IO-Link for parameter setting
Pin 2 (OUT2)	<ul style="list-style-type: none"> • Analogue signal for flow

7 Operating and display elements

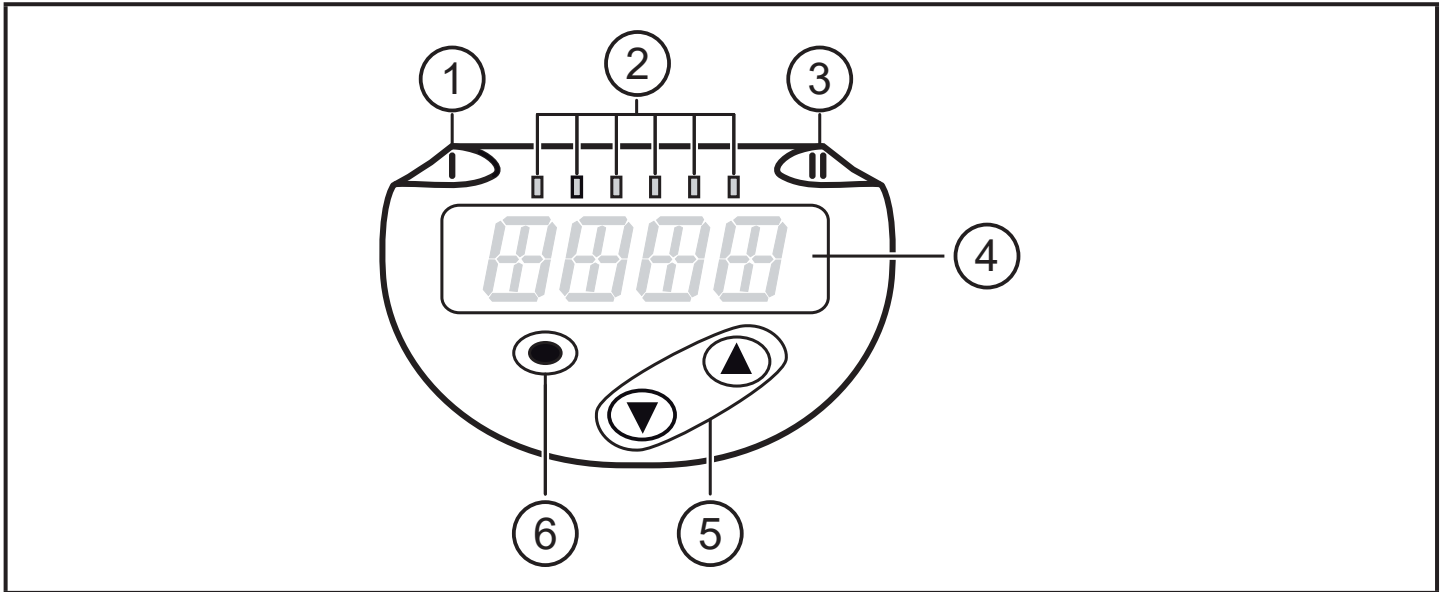

1, 2, 3: Indicator LEDs

- LED 1, 3 = without function
- LED 2 = process value in the indicated unit of measurement:
SAxx04: %, m/s, l/min, m³/h, °C, 10³
SAxx14: %, fps, gpm, cfm, °F, 10³

4: Alphanumeric display, 4 digits

- Indication of the current process values in red or green characters
- Display of the parameters and parameter values

5: Buttons up [▲] and down [▼]

- Select parameter
- Change parameter value (hold button pressed)
- Change of the display unit in the normal operating mode (RUN mode)
- Lock / Unlock (buttons pressed simultaneously > 10 seconds)

6: Button [●] = Enter

- Change from the RUN mode to the main menu
- Change to the setting mode
- Acknowledge the set parameter value

8 Menu

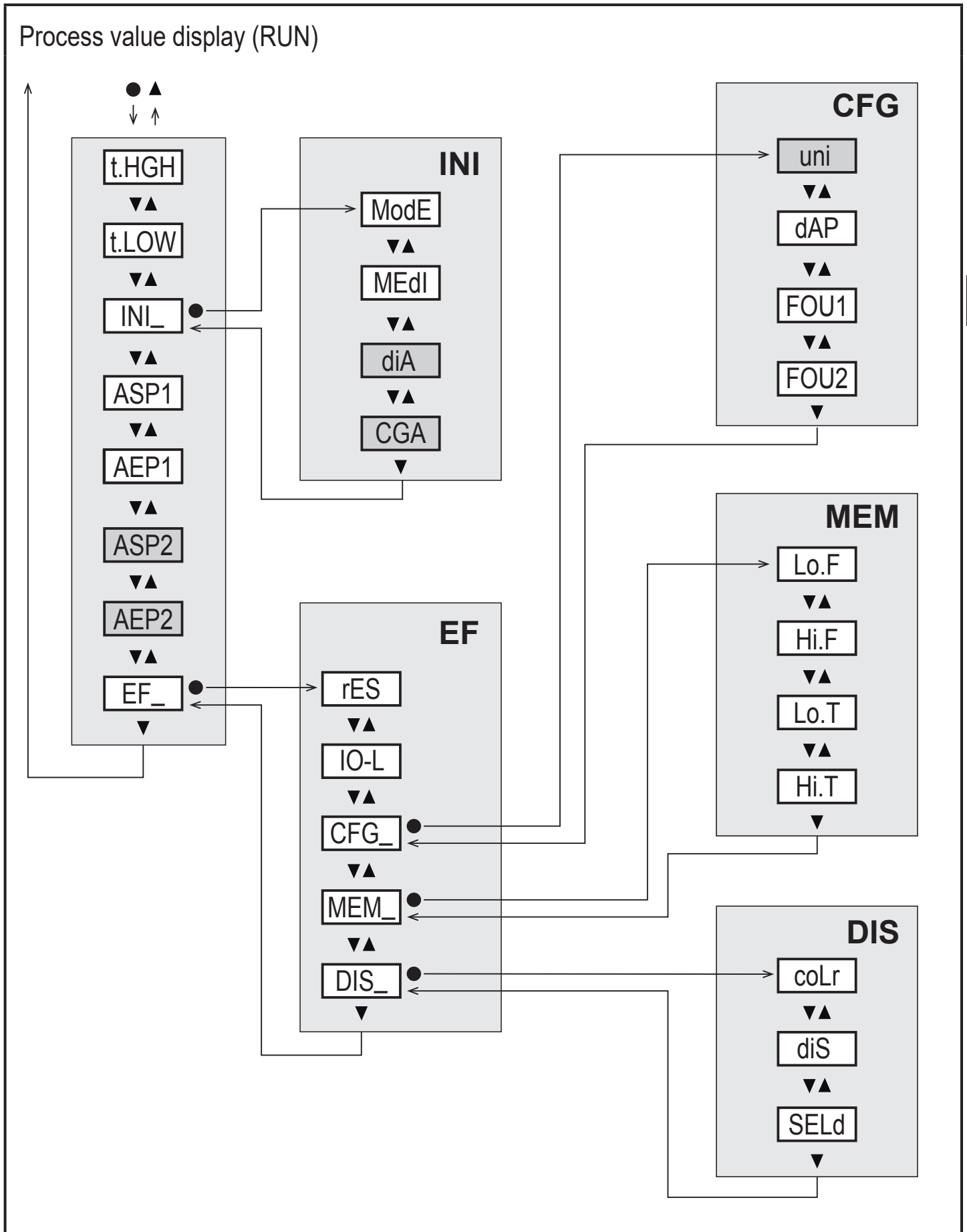

UK

Parameters with white background are indicated in case of factory setting (→ 15).

Explanation main menu

t.HGH	Flow adjustment to maximum value (high teach) = 100 % flow with the operating mode REL.
t.LOW	Flow adjustment to minimum value (low teach) = 0 % flow with the operating mode REL.
INI	Change to the Initialisation menu
ASP1	Analogue start point for temperature (OUT1) = temperature value at which the output signal is 4 mA.
AEP1	Analogue end point for temperature (OUT1) = temperature value at which the output signal is 20 mA.
ASP2	Analogue start point for flow (OUT2) = flow value at which the output signal is 4 mA.
AEP2	Analogue end point for flow (OUT2) = flow value at which the output signal is 20 mA.
EF	Extended functions. Opening of the lower menu levels.

Explanation initialisation menu (INI)

ModE	Selection of the operating mode for flow measurement: REL, LIQU, GAS.
MEdl	Medium selection: H2O, GLYC, OIL1, OIL2, AIR.
diA	Setting the internal pipe diameter in mm or inch.
CGA	Calibration of the measurement graph (gradient) in %.

Explanation extended functions (EF)

rES	Restoring the factory settings.
IO-L	Activate IO-Link communication for parameter setting.
CFG	Change to the submenu basic settings
MEM	Change to the submenu min/max memory
DIS	Change to the submenu display settings

Explanation basic settings (CFG)

uni	Standard unit of measurement for flow.
dAP	Measured value damping for flow.
FOU1	Behaviour of output 1 in case of a fault: OU, On, OFF.
FOU2	Behaviour of output 2 in case of a fault: OU, On, OFF.

Explanation min/max memory (MEM)

Lo.F	Minimum value memory for flow.
Hi.F	Maximum value memory for flow.
Lo.T	Minimum value memory for temperature.
Hi.T	Maximum value memory for temperature.

UK

Explanation display settings (DIS)

coLr	Colour configuration of the display: rEd (red), GrEN (green).
diS	Update rate and orientation of the display: d1...d3 (measured value update rate), rd1...rd3 (display rotation), OFF (display off).
SELd	Standard display: flow or medium temperature

9 Set-up

After power on and expiry of the power-on delay time, the unit is in the normal operating mode. It carries out its measurement and evaluation functions and generates output signals according to the set parameters.

For the analogue output 2 (OUT2), the output signal is at 20 mA during the power-on delay time.

In the first 2 seconds, analogue output 1 (OUT1) is passive and available for IO-Link communication. During the remaining power-on delay time, the output signal is at 20 mA.

10 Parameter setting

CAUTION

For medium temperatures above 50 °C (122 °F) some parts of the housing can heat up to over 65 °C (149 °F).

> Risk of burns.

- ▶ Do not touch the device with your hands.
- ▶ Use another object (e.g. a ballpoint pen) to carry out settings on the unit.

Parameters can be set before installation or during operation.



If you change parameters during operation, this will influence the function.

- ▶ Ensure that there will be no malfunctions in your plant.

During parameter setting the unit remains in the operating mode. It continues to monitor with the existing parameter until the parameter setting has been completed.



The parameters can also be set via the IO-Link interface (→ 4.7).

10.1 Parameter setting in general

1. Change from the RUN mode to the main menu	[●]
2. Select the requested parameter	[▲] or [▼]
3. Change to the setting mode	[●]
4. Change the parameter value	[▲] or [▼] > 1 s
5. Acknowledge the set parameter value	[●]
6. Return to the RUN mode	> 30 seconds (timeout) or press [▲] + [▼] simultaneously until the RUN mode is reached.



By pressing [▲] + [▼] simultaneously you exit the setting mode without saving the changed parameter.

10.1.1 Switch between the menus

1. Change from the RUN mode to the main menu	[●]
2. Select the parameter EF	[▼]
3. Change to the sub-menu EF	[●]
4. Select the parameters CFG, MEM, DIS	[▼]
5. Change to the sub-menus CFG, MEM, DIS	[●]
6. Return to the next higher menu level	Press [▲] + [▼] simultaneously

UK

10.1.2 Change to the process value display (RUN mode)

There are 3 possibilities:

I.	Wait for 30 seconds (→ 10.1.4 Timeout).
II.	Press [▲] until the RUN mode is reached.
III.	Press [▲] + [▼] simultaneously until the RUN mode is reached.

10.1.3 Lock / unlock

The unit can be locked electronically to prevent unintentional settings.

On delivery: not locked.

Lock	<ul style="list-style-type: none">▶ Make sure that the unit is in the normal operating mode.▶ Press [▲] and [▼] simultaneously for 10 s until [Loc] is displayed.
Unlock	<ul style="list-style-type: none">▶ Make sure that the unit is in the normal operating mode.▶ Press [▲] and [▼] simultaneously for 10 s until [uLoc] is displayed.

10.1.4 Timeout

If no button is pressed for 30 s during parameter setting, the unit returns to the operating mode with unchanged values.

10.2 Settings for volumetric flow monitoring



- ▶ Select the operating mode [ModE] first before doing all the other settings (→ 10.2.1).



For the operating modes GAS and LIQU, the flow values are set in the unit defined in [uni].

- ▶ If necessary, change the unit before setting the flow values.
For the operating mode REL the unit % is always used.

10.2.1 Define the operating mode

<ul style="list-style-type: none">▶ Select [ModE] and define the operating mode: REL, GAS, LIQU. <p> A medium and an internal pipe diameter must be entered for the operating modes LIQU and GAS. When the factory setting is changed (ModE = REL), the unit displays [≡≡≡≡] to force these entries:</p> <ul style="list-style-type: none">▶ Press [●].> [MEdI] is displayed.▶ Define medium.> [diA] is displayed.▶ Define the internal pipe diameter in mm or inch. <p> The operating mode REL requires a flow adjustment → 10.2.4.</p> <p> A change of the operating mode leads to a restart of the unit. The settings are saved in the respective operating mode, i.e. after a change of the operating mode the settings are not lost.</p>	Menu INI: [ModE]
---	---------------------

10.2.2 Define the internal pipe diameter

<ul style="list-style-type: none">▶ Select [diA] and define the internal pipe diameter: SAxx04: 15...400 mm SAxx14 0,6...16 inch <p> [diA] is only available if the operating mode GAS or LIQU is selected.</p>	Menu INI: [diA]
---	--------------------

10.2.3 Configure the analogue output for flow (OUT2)

<ul style="list-style-type: none">▶ Select [ASP2] and set the flow value at which the output signal is 4 mA.▶ Select [AEP2] and set the flow value at which the output signal is 20 mA. <p> [ASP2] and [AEP2] are only available if the operating mode GAS or LIQU is selected.</p>	Main menu: [ASP2] [AEP2]
--	--------------------------------

10.2.4 Carry out the flow adjustment

<ol style="list-style-type: none">1. High-flow adjustment:<ul style="list-style-type: none">▶ Switch on the supply voltage.▶ Activate the maximum flow in the installation.▶ Select [t.HGH] and press [●].> [tch] is indicated.▶ Keep [▲] or [▼] pressed.> [----] is displayed.▶ Briefly press [●].> Display [donE]: adjustment successful. Display [FAIL]: repeat the adjustment.> The unit defines the existing flow as maximum flow (final value of the measuring range = 100 %).▶ Briefly press [●].2. Low-flow adjustment:<ul style="list-style-type: none">▶ Switch on the supply voltage.▶ Activate the minimum flow in the installation.▶ Select [t.LOW] and press [●].> [tch] is indicated.▶ Keep [▲] or [▼] pressed.> [----] is displayed.▶ Briefly press [●].> Display [donE]: adjustment successful. Display [FAIL]: repeat the adjustment.> The unit defines the existing flow as minimum flow (0 %).▶ Briefly press [●]. <p> [t.HGH] and [t.LOW] are only available if the operating mode REL is selected.</p>	Main menu: [t.HGH] [t.LOW]
---	----------------------------------

UK

10.3 Settings for temperature monitoring

10.3.1 Analogue output for temperature (OUT1)

<ul style="list-style-type: none">▶ Select [ASP1] and set the temperature value at which the output signal is 4 mA.▶ Select [AEP1] and set the temperature value at which the output signal is 20 mA.	Main menu: [ASP1] [AEP1]
--	--------------------------------

10.4 User settings (optional)

10.4.1 Configure standard display

<ul style="list-style-type: none">▶ Select [SELd] and determine the standard unit of measurement:<ul style="list-style-type: none">- FLOW = current flow in the standard unit of measurement is displayed.- TEMP = current medium temperature in °C (SAxx14: °F) is displayed.▶ Select [diS] and set the update rate and orientation of the display:<ul style="list-style-type: none">- d1, d2, d3: update of the measured values every 50, 200, 600 ms.- rd1, rd2, rd3: display as for d1, d2, d3; rotated by 180°.- OFF = measured value display is deactivated in the RUN mode. <p> The LEDs remain active even if the display is deactivated. Error messages are displayed even if the display is deactivated.</p>	Menu DIS: [SELd] [diS]
---	------------------------------

10.4.2 Set the standard unit of measurement for flow

<ul style="list-style-type: none">▶ Select [uni] and set the unit of measurement: SAxx04: l/min, m³/h, m/s SAxx14: cfm, gpm, fps <p> [uni] is only available if the operating mode GAS or LIQU is selected. For the operating mode REL the flow value is always displayed in % of the measuring range.</p>	Menu CFG: [uni]
---	--------------------

10.4.3 Select the medium

<ul style="list-style-type: none">▶ Select [MEdI] and define the medium to be monitored: H2O, OIL1*, OIL2**, GLYC, AIR. <p> Depending on the operating mode different media are available (→ 4.2).</p> <p>*OIL1 = high-viscosity oil (≥ 40 mm²/s at 40 °C / ≥ 40 cSt at 104 °F) **OIL2 = low-viscosity oil (≤ 40 mm²/s at 40 °C / ≤ 40 cSt at 104 °F)</p>	Menu INI: [MEdI]
---	---------------------

10.4.4 Define colour of the display

▶ Select [coLr] and define the colour of the process value display: rEd (display always red), GrEn (display always green).	Menu DIS: [coLr]
---	---------------------

10.4.5 Set the measured value damping

▶ Select [dAP] and set the damping constant in seconds (T value 63 %): 0...5 s (→ 4.6).	Menu CFG: [dAP]
--	--------------------

10.4.6 Set output status in fault condition

▶ Select [FOU1] or [FOU2] and set the value: <ul style="list-style-type: none">- On = The analogue signal goes to the upper fault value (→ 4.5).- OFF = The analogue value goes to the lower fault value (→ 4.5).- OU = The analogue signal corresponds to the measured value.	Menu CFG: [FOU1] [FOU2]
--	-------------------------------

UK

10.4.7 Calibrate curve of measured values

▶ Select [CGA] and set a percentage between 60 and 140 (→ 4.4). 100 % = factory setting.	Menu INI: [CGA]
 [CGA] is only available if the operating mode GAS or LIQU is selected.	

10.5 Service functions

10.5.1 Read min/max values

<p>▶ Select [Lo.x] or [Hi.x]. [Lo.F] = minimum flow value , [Hi.F] = maximum flow value [Lo.T] = minimum temperature value , [Hi.T] = maximum temperature value</p> <p>Delete memory:</p> <p>▶ Select [Lo.x] or [Hi.x].</p> <p>▶ Keep [▲] or [▼] pressed.</p> <p>> [----] is displayed.</p> <p>▶ Briefly press [●].</p> <p> It is recommended to delete the memories as soon as the unit operates under normal operating conditions for the first time. In the operating mode REL a new teaching process deletes the memory.</p>	Menu MEM: [Lo.F] [Hi.F]
---	-------------------------------

10.5.2 Reset all parameters to factory setting

<p>▶ Select [rES] and press [●].</p> <p>▶ Keep [▲] or [▼] pressed.</p> <p>> [----] is displayed.</p> <p>▶ Briefly press [●].</p> <p>> Return to the RUN mode.</p> <p> It is recommended to note down your own settings before carrying out a reset (→ 15 Factory setting).</p>	Menu EF: [rES]
--	-------------------

11 Operation

After power on, the unit is in the Run mode (= normal operating mode). It carries out its measurement and evaluation functions and provides output signals according to the set parameters.

11.1 Read the process value

It can be preset whether flow or temperature is indicated as default (→ 10.4.1 Configure standard display).

A standard unit of measurement can be defined for the flow measurement (l/min or m³/h or m/s; for SAxx14: gpm, cfm or fps → 10.4.2). For the operating mode REL flow is always displayed in %.

The display can be changed to another display unit in addition to the preset standard display:

- ▶ Press [▲] or [▼].
- > The display changes, the indicator LEDs indicate the current display unit.
- > After 30 seconds the display changes to the standard display.

11.2 Read the set parameters

- ▶ Briefly press [●]
- ▶ Press [▼] to select the parameter.
- ▶ Briefly press [●]
- > The currently set value is displayed for 30 s. Then the unit returns to the process value display.

UK

12 Technical data

Technical data and scale drawing at www.ifm.com.

13 Fault correction

The unit has many self-diagnostic options. It monitors itself automatically during operation.

Warnings and error states are displayed even when the display is switched off. Error indications are also available via IO-Link.

Display	Type	Description	Fault correction
Err	Error	• Unit faulty / malfunction.	▶ Replace the unit.
No display	Error	• Supply voltage too low. • Setting [diS] = OFF.	▶ Check the supply voltage. ▶ Change the setting [diS] → 10.4.1.
PArA	Error	Parameter setting outside the valid range.	▶ Check parameter setting.
Loc	Warning	Setting pushbuttons on the unit locked, parameter change rejected.	▶ Unlock the unit → 10.1.3.
C.Loc	Warning	Setting buttons on the unit temporarily locked, parameter setting via IO-Link communication active.	▶ Finish parameter setting via IO-Link communication.

Display	Type	Description	Fault correction
S.Loc	Warning	Setting buttons locked via parameter software, parameter change rejected.	▶ Unlock the unit via IO-Link interface using the parameter setting software.
UL	Warning	Below the display range: temperature value < - 20 % MEW (→ 4.5).	▶ Check temperature range. ▶ Repeat low-flow adjustment.
OL	Warning	Display range exceeded: measured value > 120 % of MEW (→ 4.5).	▶ Check flow range / temperature range. ▶ Repeat high-flow adjustment.
SC1	Warning	Switching status LED for OUT1 flashing: short circuit OUT1.	▶ Check switching output OUT1 for short-circuit or excessive current.
SC2	Warning	Switching status LED for OUT2 flashing: short circuit OUT2.	▶ Check switching output OUT2 for short-circuit or excessive current.
SC	Warning	Switching status LEDs for OUT1 and OUT2 flashing: short circuit OUT1 and OUT2.	▶ Check switching outputs OUT1 and OUT2 for short-circuit or excessive current.
FAIL	Warning	Faulty low-flow or high-flow adjustment (e.g. the distance between maximum and minimum flow is too small).	▶ Repeat flow adjustment.

MEW = final value of the measuring range

14 Maintenance

- ▶ From time to time check the sensor tip for build-up.
- ▶ Clean with soft cloth. Stubborn build-up, for example lime can be removed using a common vinegar cleaning agent.

15 Factory setting

Parameters	Factory setting	User setting
ASP1	0 %	
AEP1	100 %	
ASP2	0 %	
AEP2	100 %	
diA	----	
uni	SАxx04 SАxx14 l/min gpm	
dAP	0.6 s	
MEdI	H2O	
FOU1	OFF	
FOU2	OFF	
CGA	100 %	
ModE	REL	
coLr	rEd	
diS	d2	
SELd	FLOW	

UK

The percentage values refer to the final value of the measuring range (MEW).

ООО "РусАвтоматизация"

454010 г. Челябинск, ул. Гагарина 5, оф. 507

тел. 8-800-775-09-57 (звонок бесплатный), +7(351)799-54-26, тел./факс +7(351)211-64-57

info@rusautomation.ru; [русавтоматизация.рф](http://rusавтоматизация.рф); www.rusautomation.ru