

**Building on experience.
Harnessing progress.
Advancing technology.**



Ultrasonic Sensors for Any
Industrial Application



Your automation, our passion.



Find Your Ultrasonic Sensor in Just a Few Clicks

Go online. Specify your requirements. Select your device. You can find the right solution for your application in just a few clicks. If you have any questions, our experts are available to take your call.

Online Search on the Pepperl+Fuchs Website

Enter the model number in the search field on the Pepperl+Fuchs website and get to your product selection immediately. Model numbers can be found in this brochure in the technical data summaries. Or you can navigate through our range of product families and groups. Product selectors help you select the optimal ultrasonic sensor.

For example,
"UB100-F77"

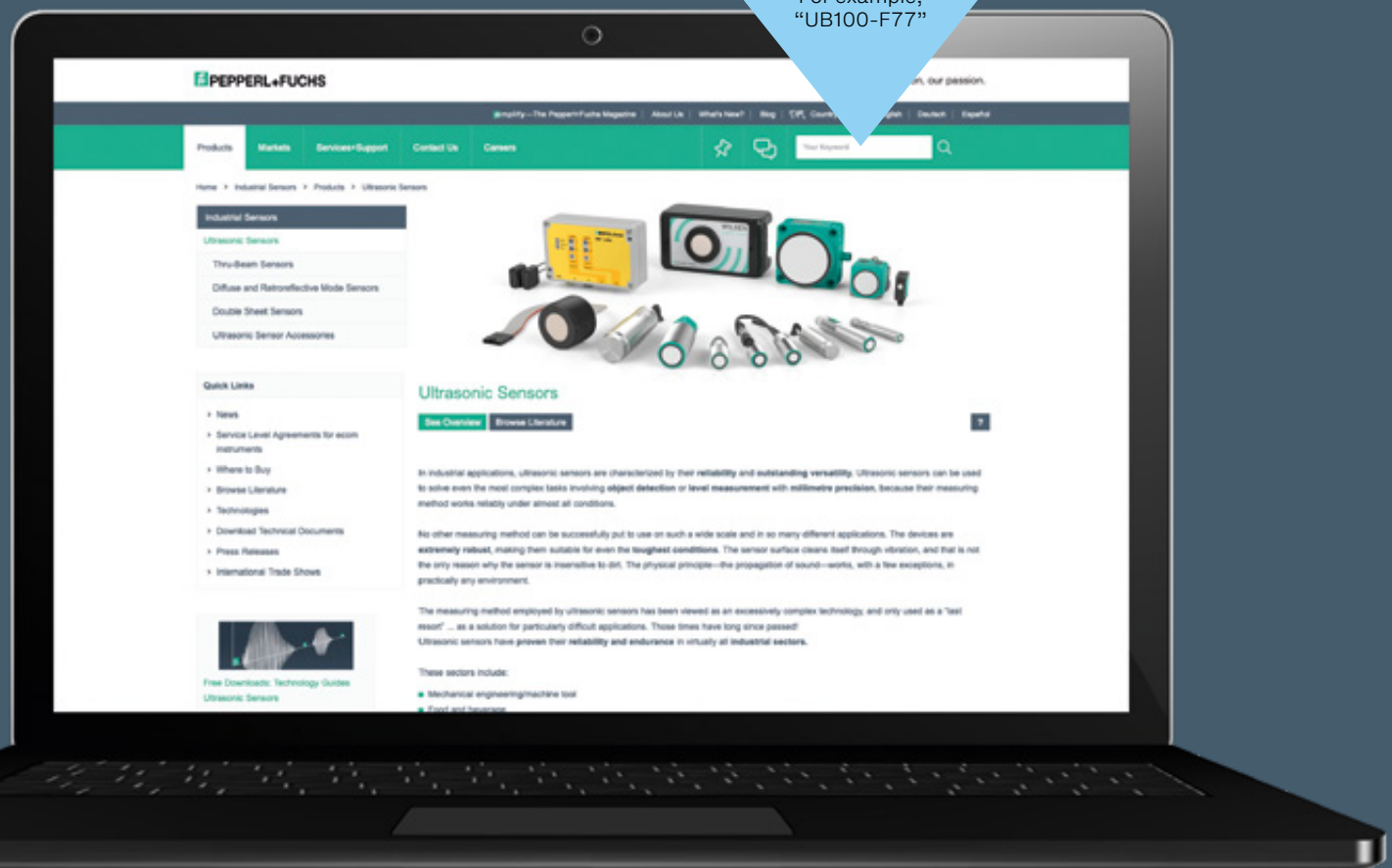

For more information, visit
pepperl-fuchs.com/ultrasonicsensors

Contents

Ultrasonic Sensor Technology from Pepperl+Fuchs	4
Ultrasonic Technology—Function and Advantages	6
Products	10
Cube-Style Ultrasonic Sensors	10
Cylindrical Ultrasonic Sensors	16
Chemically Resistant Ultrasonic Sensors	24
Safety Sensors	28
Ultrasonic Modules	30
Wireless Sensors	32
Double Material Detection	34
Double Sheet Detection	36
Splice Detection/Label Detection	38
Accessories	39

Innovation and Expertise Right from the Start

With our unique expertise in developing and manufacturing ultrasonic sensors, Pepperl+Fuchs is working on the application solutions of the future. Our ultrasonic portfolio combines decades of in-house expertise in ultrasonic transducers, an ultrasonic technology center, and comprehensive expert knowledge—for future-proof, application-oriented sensor solutions.

Top Quality and Performance

Ultrasonic sensors from Pepperl+Fuchs are built in our own technology center, where transducer development and manufacturing take place. For more than 30 years, our forward-thinking team of experts has been working continually to advance ultrasonic technology for the solutions of tomorrow. That means our customers always receive the highest-performance products on the market.

This approach has led to the broadest portfolio in the industry—supported by numerous patents and innovations—for the highest level of flexibility in product selection and optimal application solutions. In addition to our standard portfolio, Pepperl+Fuchs has the knowledge and infrastructure to respond to customer requirements with speed and flexibility.

Ultrasonic Sensors for Any Industrial Application

Ultrasonic sensors are used to detect objects and measure distance in industrial applications where versatility and reliability are key. Pepperl+Fuchs offers a wide variety of ultrasonic sensors that feature benefits like minimal dead bands, large measuring ranges of up to 10 m, adjustable sound beams, and much more—and all in a variety of housing designs, so we can always offer reliable and efficient solutions.

Sensorik4.0®— Paving the Way for the Smart Factory

In the “Industry 4.0” future of fully networked production systems, communication-ready sensors play a vital role because they send and receive sensor data within production processes and to higher-level, local, or cloud-based information systems. To pave the way for Industry 4.0, Pepperl+Fuchs is providing innovative sensor technologies with Sensorik4.0®. They use the standard IO-Link interface to support the digitization of industrial applications.



Deepen your knowledge of ultrasonic sensors with Pepperl+Fuchs' Ultrasonic Technology Guide: pepperl-fuchs.com/technology-guide

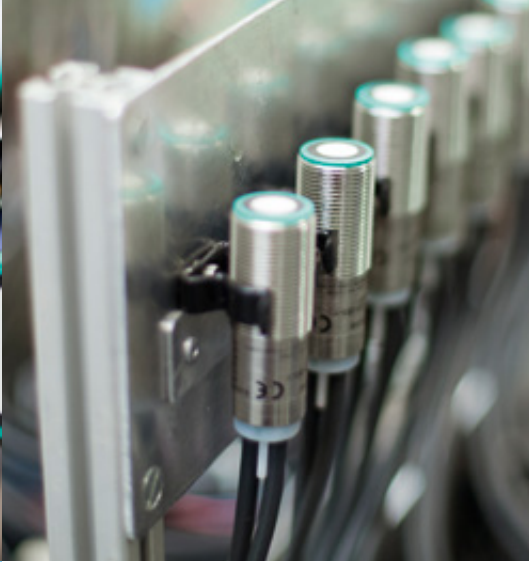

One Technology—Limitless Versatility

Ultrasonic technology is known for its reliability and outstanding versatility. It's up to the challenge when other technologies reach their limits. That's because ultrasound has qualities that make it the ideal sensing technology for a variety of applications. Ultrasonic sensors can be used for even the most complex detection and monitoring tasks, because their measuring method works reliably under almost all conditions.

Extremely Versatile and Reliable

Wood, metal, or plastic; colored, reflective, or transparent; solid, liquid, or powder—the versatility of ultrasonic technology is almost limitless. The wide range of applications is demonstrated by the technology's insensitivity to countless materials, surface types, and colors. Whether in a conventional industrial environment or in more specialized areas such as agriculture, the chemical industry, or food industry, ultrasonic sensors are extremely versatile. This is true even in harsh environments where other technologies reach their limits.

Ultrasonic Technology for Superior Performance

Ultrasonic sensors offer impressive functionality, taking measurements by transmitting high-frequency sound pulses that are completely inaudible to humans. These pulses spread out in a cone shape into the air and are reflected as soon as they hit a surface. The sensors operate according to a time-of-flight measurement, by which they measure the time between transmitting the sound waves and receiving the object reflection. This allows objects to be detected and their distance from the sensor to be measured. Pepperl+Fuchs ultrasonic sensors are equipped with integrated temperature compensation for reliable and accurate measurement.



The Right Sensing Mode for Every Application

Whether it's with analog or digital output, or as a diffuse, retroreflective, or thru-beam sensor—ultrasonic sensors open up a wide range of automation solutions. Pepperl+Fuchs provides a comprehensive product range encompassing all operating modes, so we can offer the right ultrasonic sensor for every possible application.

Diffuse Mode Sensor: Detection and Measurement with Just One Ultrasonic Transducer

In a diffuse mode sensor, the ultrasonic transducer is both an emitter and receiver. This single-housing design simplifies installation and is well suited for fill level detection in tanks. The surface of liquids or granular material reflects the emitted sound waves, meaning the sensor can detect a limit level while continually measuring the level.

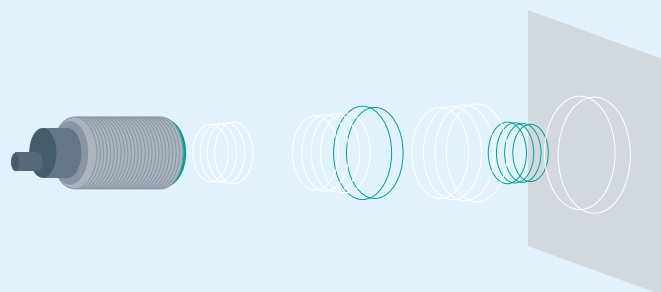

Retroreflective Sensor: Background as Reference Ensures Reliable Sensor Function

A retroreflective sensor uses the background (such as a conveyor belt, machine part, or the floor) as a reflector rather than the object itself. In this operating mode, sensors detect any change—whether the objects are small or large, sitting at an angle, or made of sound-absorbing material. The single-housing design guarantees easy installation, wiring, and commissioning.

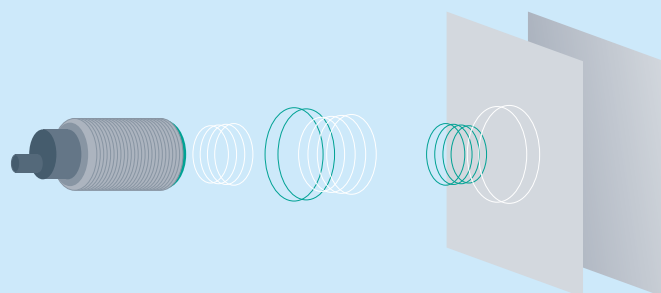

Thru-Beam Sensor: Long Ranges and High Switching Frequencies

Thru-beam sensors use separate emitter and receiver transducers. If a bottle or another object interrupts the sound beam, the electronics in the receiver trigger a switching signal. Even smooth, angled surfaces are detected reliably in this way. A significantly higher switching frequency also makes thru-beam sensors suitable for a wide range of high-speed applications.

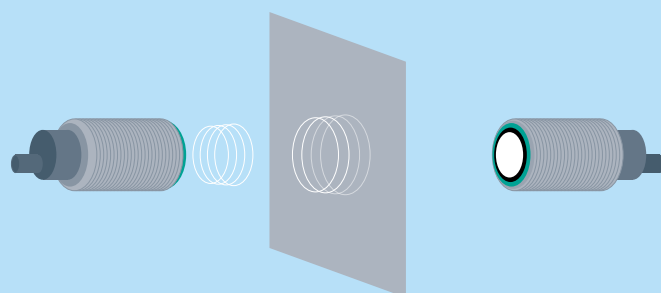

Using Technology to Its Full Potential

No two applications are the same—each one places unique demands on a sensor. To provide reliable measurements at any time, Pepperl+Fuchs combines the advantages of ultrasonic technology with high-performance sensor solutions that meet the toughest challenges in any environment.



Individually Adjustable Sound Beam Ensures Fault-Free Performance

Ultrasonic sensors use a sound beam for detection. This provides maximum reliability because detection is performed within a field rather than at a specific point. If objects are causing interference—like steps on the interior wall of a tank—the sound signal can be narrowed. This means no expensive changes need to be made to the tank. The detection range and full detection performance remain unchanged.

Universal Sensing Technology That Can Handle Any Environment

Ultrasound is a technology that can be used anywhere, offering impressive performance even in tough conditions such as snow, fog, or dust. The ambient temperature can affect the transit time of the high-frequency pulses, but ultrasonic sensors from Pepperl+Fuchs compensate for this internally. That means the user can always rely on the sensor regardless of temperature changes.

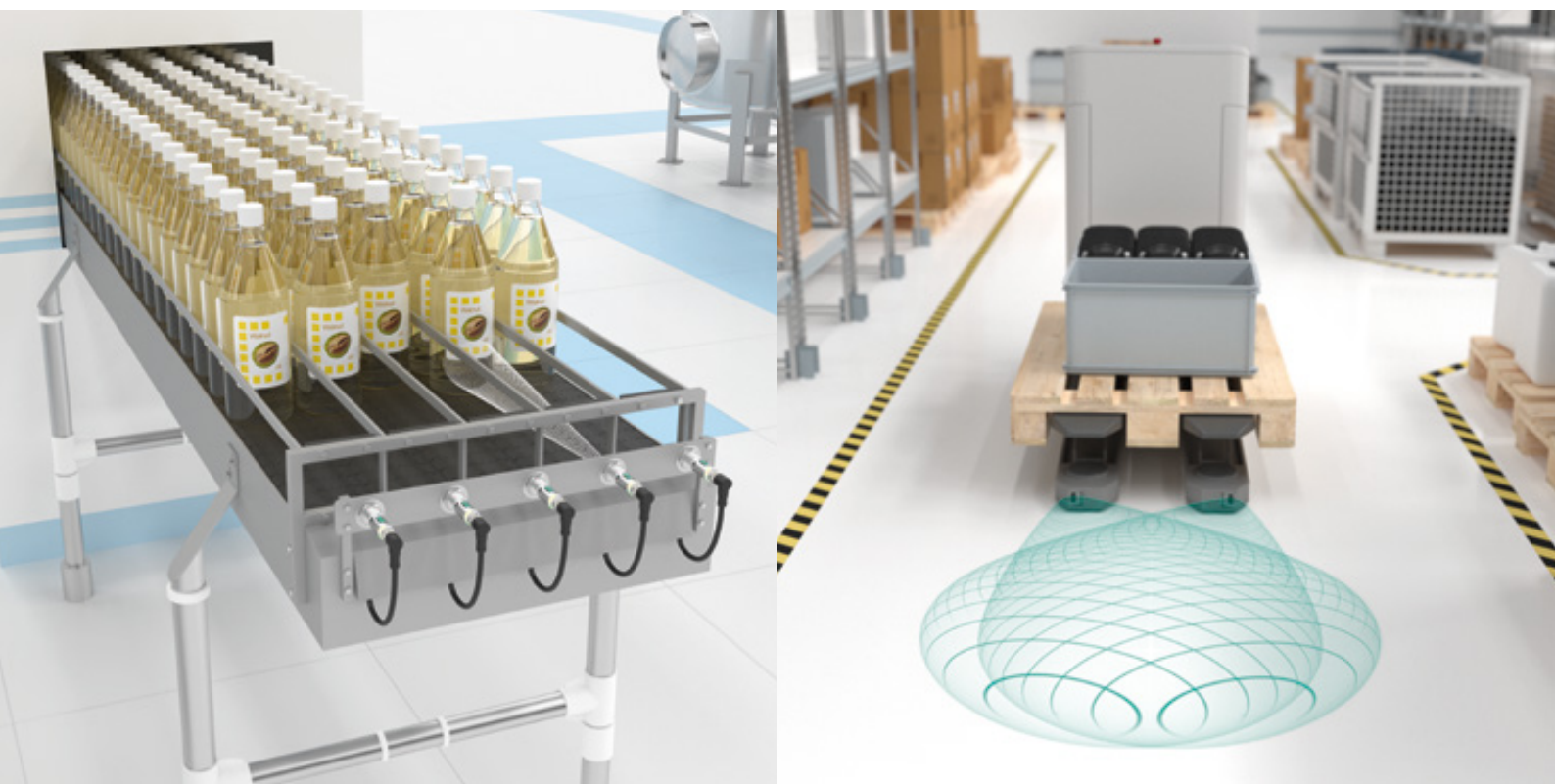

Synchronization: Fault-Free Operation When Using Several Sensors in Tight Spaces

When several ultrasonic sensors are installed close together, they can interfere with each other. To correct this, two operating modes are available, depending on the application. When synchronized in multiplex mode, the sensors send signals alternately and analyze their own echo. In common mode, all sensors transmit at the same time and analyze all received echoes. In both scenarios, maximum functional safety is ensured.

Ideal for Safety, IoT Applications, and Special Applications Thanks to Additional Functions

A number of special ultrasonic sensors are available to the user for special applications:

- PL d-certified safety sensors for personnel and machine protection in safety applications
- Self-sufficient IoT sensors for level applications
- Corrosion-resistant solutions for use in environments containing aggressive media and gases



Cube-Style Housings: Broad Portfolio for a Variety of Industrial Applications

Our wide range of cube-style ultrasonic sensors offers the right solution for virtually any application. Special designs and features such as minimized dead bands, extended ranges, and extra-robust versions give the user the greatest possible flexibility.

Extreme Performance in Reduced Space



F77 Series

With IO-Link, sound beam adjustment, synchronization, long detection ranges of up to 800 mm, and minimal dead bands, F77 series ultrasonic sensors offer an unparalleled range of features and adjustment options. The series is available in a standard or side-looker version with integrated M18 thread. The minimized dead bands and long detection range mean objects close to the sensor and farther away are detected reliably. The sound beam width is easy to switch depending on requirements. At the same time, automatic sensor synchronization allows sensors to operate without cross-talk when installed close together. The highest level of detection reliability is guaranteed even when there are interfering surfaces or strong vibrations from compressed air tools. The IO-Link interface enables quick commissioning via the control panel and provides valuable diagnostic information.

Highlights

- Highly adaptable: a single sensor can be adjusted to fit a wide range of applications
- Precise and reliable: high noise immunity and multiplex capability for maximum reliability
- Simple integration: compact, space-saving housing design with thru-hole and surface-mount options
- Convenient commissioning: intuitive programming and parameterization
- Parameterization and control: communication to the sensor level with IO-Link

Technical Data	UB100-F77	UB250-F77	UB400-F77	UBR250-F77	UBR400-F77	UBE800-F77	UC250-F77	UC400-F77	UC800-F77S
Sensing mode	Diffuse			Retroreflective		Thru-beam	Diffuse		
Sensing range	10 ... 100 mm	20 ... 250 mm	25 ... 400 mm	0 ... 250 mm	0 ... 400 mm	0 ... 800 mm	20 ... 250 mm	30 ... 400 mm	60 ... 800 mm
Operating voltage	20 ... 30 V DC						10 ... 30 V DC (18 ... 30 V DC analog output versions)		
Output type	1 switching output (PNP or NPN, NO, or NC contact)/ 1 analog output (Frequency)			1 switching output (PNP or NPN, NO, or NC contact)		1 switching output (PNP, NO, or NC contact)	1 switching output (push-pull output) 1 analog output (current or voltage)		

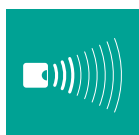

Detection range max. 800 mm

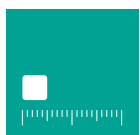

Dimensions 31 x 23 x 12 mm

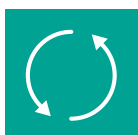

Synchronizable



Degree of protection IP67



UC-F77 with IO-Link



Numerous parameterization options

Extremely Flexible and Powerful



L2 Series

L2 series ultrasonic sensors offer a unique range of possibilities. The key features are the sensor's cube-like design and the adjustable sensor head, which provides a host of integration options. During commissioning, a wide selection of parameters can either be set directly on the device or on a PC—for example, using the device type manager in the PACTware user interface.

The IP67 degree of protection provides the best conditions for ensuring maximum availability in harsh industrial environments. The versions with an extended temperature range of $-40\text{ }^{\circ}\text{C}$ to $+70\text{ }^{\circ}\text{C}$ and a fixed cable connection enable the series to be used at especially low temperatures. The versions with an integrated CAN interface, IP68 degree of protection, and E1 approval allow for optimum use in vehicles and mobile devices.

Highlights

- Wide array of ranges enables use even in long-range applications
- Rotating sensor head for customizable installation
- Automatic sensor synchronization for optimum functional reliability when several sensors are mounted near each other
- Mounting and connection compatible with the inductive sensors of the VariKont L series
- Optimized for vehicles and mobile equipment—CAN interface and special connector options enable easiest integration

Technical Data	UC500-L2 UC500-L2M-*T	UC2000-L2 UC2000-L2M-*T	UC4000-L2 UC4000-L2M-*T	UC500-L2M- B16-*	UC2000-L2M- B16-*	UC4000-L2M- B16-*
Sensing mode	Diffuse	Diffuse	Diffuse	Diffuse	Diffuse	Diffuse
Sensing range	35 ... 500 mm	60 ... 2,000 mm	200 ... 4,000 mm	35 ... 500 mm	60 ... 2,000 mm	200 ... 4,000 mm
Operating voltage	10 ... 30 V DC/12 ... 30 V DC (analog voltage output)			9 ... 30 V DC		
Output type	1 switching output (PNP or NPN)/ 2 switching outputs (both PNP or both NPN)/ 1 analog output (current or voltage)			CANopen		



Detection range
max. 4,000 mm

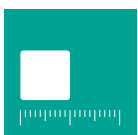

Dimensions
40 × 40 × 67 mm

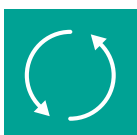

Synchronizable



Degree of
protection

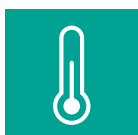

$-40\text{ }^{\circ}\text{C}$ to $+70\text{ }^{\circ}\text{C}$
(UC-L2M-*T*)



CAN interface
(UC-L2M-B16-*)

Compact Solution for Narrow Spaces

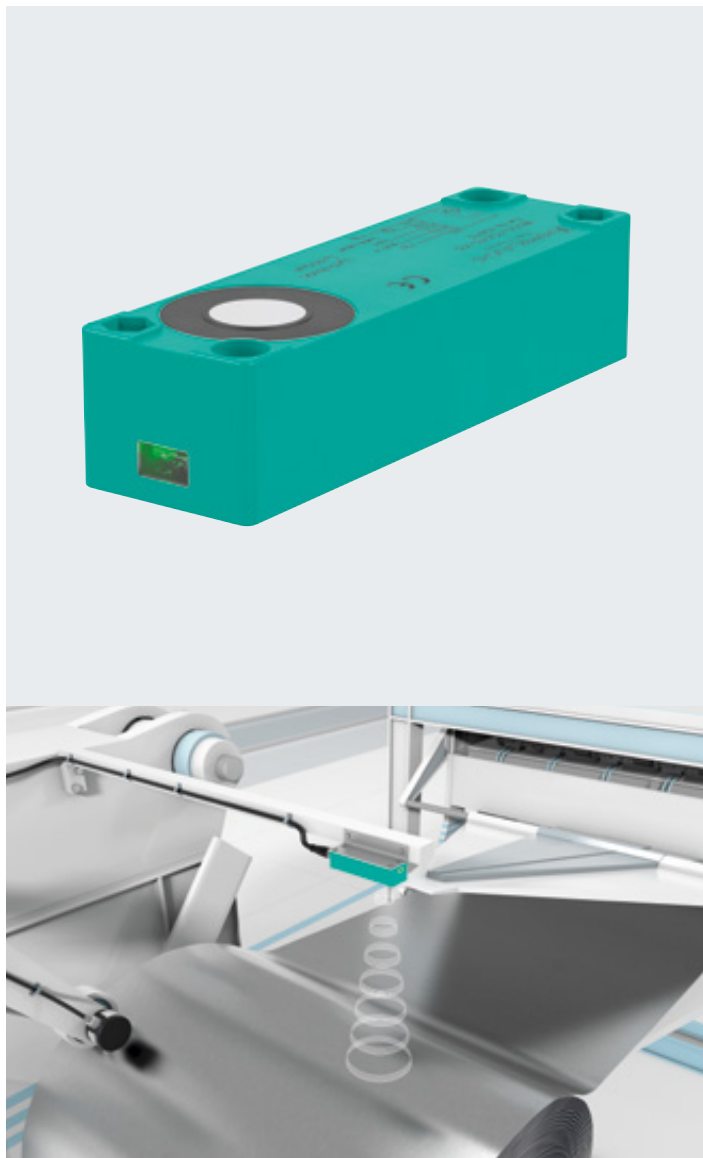

F54 Series

The F54 diffuse mode sensor shows its strengths wherever mounting space is limited, while offering synchronization capabilities and a long detection range of up to two meters. User-friendly configuration is possible via the teach-in input.

The F54 can be used in applications like bottle reverse vending machines or in the detection of roll diameters, for example, when handling endless web-like materials such as aluminum, film, or fabrics. The sensor continuously detects the diameter and gives the user an early warning when the roll falls below the minimum diameter and must be changed.

Highlights

- Detection range of up to 2 m in a narrow housing design
- User-friendly teach-in input
- IP65 rating for maximum availability
- Automatic sensor synchronization prevents cross-talk between multiple sensors

Technical Data	UB500-F54	UB2000-F54
Sensing mode	Diffuse	Diffuse
Sensing range	30 ... 500 mm	80 ... 2,000 mm
Operating voltage	10 ... 30 V DC/15 ... 30 V DC (analog voltage output)	
Output type	1 switching output (PNP or NPN)/ 1 analog output (current or voltage)	



Detection range
max. 2,000 mm



Dimensions
105 × 32 × 25 mm

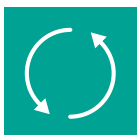

Synchronizable



Degree of
protection

Reliable Long-Range Detection



F42 Series

With their universal housing design and operating voltage, F42 series ultrasonic sensors are truly economical and versatile.

The six-meter detection range makes the sensor ideal for long-range applications, and the teach button makes commissioning easy.

The diffuse mode sensor may be also used in such applications as automatic door and gate systems, where the sensor provides reliable security. With its wide range power supply, long sensing range, and relay contact output, the F42 offers the functions needed for long-range applications.

Highlights

- Up to 6 m detection range: the long-range solution for objects located at long distances and for large gate dimensions
- Switch points and output functions can be configured using the teach buttons, ensuring simple commissioning
- AC voltage operation and relay contact output for door and gate monitoring

Technical Data	UB500-F42(S) (UB400-F42(S) UK)	UB2000-F42(S) (UB1500-F42(S) UK)	UB4000-F42 (UB3000-F42 UK)	UB6000-F42 (UB5000-F42 UK)
Sensing mode	Diffuse	Diffuse	Diffuse	Diffuse
Sensing range	30 ... 500 mm (40 ... 400 mm)	60 ... 2,000 mm (70 ... 1,500 mm)	200 ... 4,000 mm (200 ... 3,000 mm)	350 ... 6,000 mm (350 ... 5,000 mm)
Operating voltage	10 ... 30 V DC/17 ... 30 V DC (analog voltage output) (22 ... 253 V AC/DC)			
Output type	1 switching output (PNP or NPN)/2 switching outputs (both PNP or both NPN)/ 1 analog output (current or voltage) (1 relay contact output)			

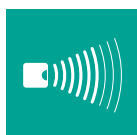

Detection range
max. 6,000 mm

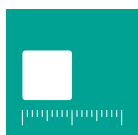

Dimensions
80 × 80 × 34 mm

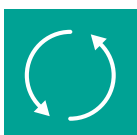

Synchronizable,
except UK



Degree of
protection

Maximum Range for Heavy-Duty Applications

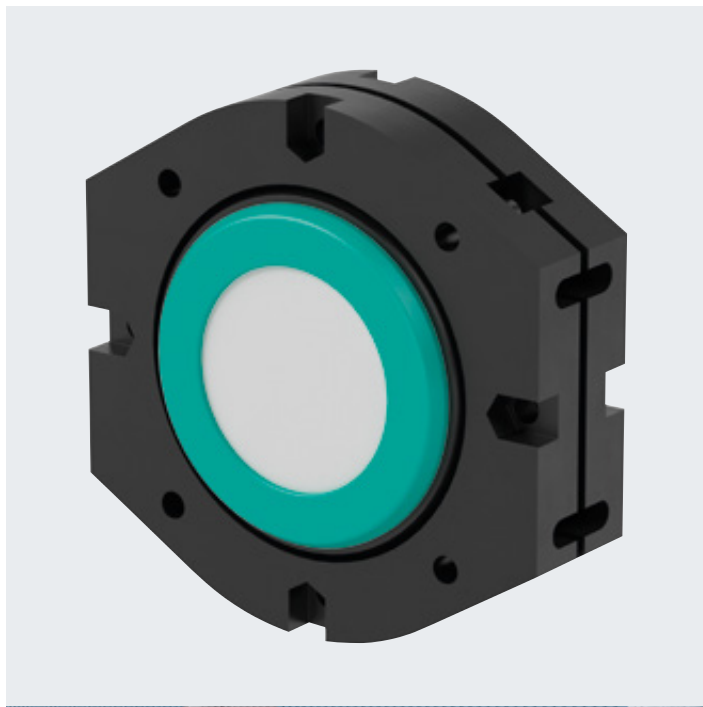

F260 Series

Heavy-duty applications push many sensors past their limits—but not the F260 series. Whether it's shock and vibration from construction machinery, excavators, and cranes, or dust from gravel and cement, these challenges are no problem for this rugged, diffuse mode ultrasonic sensor.

The sensor can be parameterized via software, and the switching points can be configured using the potentiometer. The extra-long detection range of up to 10 m is ideal for outdoor use in bunkers and silos, and the F260 is perfect for collision protection of crane booms.

Highlights

- Robust design ensures highest level of availability in heavy-duty applications
- Range of up to 10 m enables reliable long-range detection
- Simple adjustment via potentiometer and user-friendly software
- One analog output and two switching outputs

Technical Data

UC10000-F260

Sensing mode	Diffuse
Sensing range	800 ... 10,000 mm
Operating voltage	15 ... 30 V DC
Output type	1 analog output (current or voltage) + 2 switching outputs (PNP, NO, or NC contact)

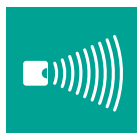

Detection range
max. 10,000 mm

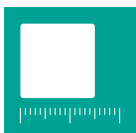

Dimensions
Ø 160 × 112 mm

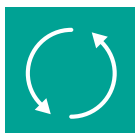

Synchronizable



Degree of
protection



Cylindrical Housings: Application-Specific Solutions in Standard Designs

With their standard design, our cylindrical ultrasonic sensors are easy to integrate into any machine environment. Special features such as offset or angled transducers increase the possibilities for integration. The product range is well suited to application-specific solutions in chemically aggressive environments, offering the user maximum flexibility for an optimal application solution—both in standard and specialized industrial applications.

Space-Saving with a Long Service Life



12GM Series

The highly compact cylindrical M12 housing in combination with the extra-small dead bands make 12GM series ultrasonic sensors the ideal solution for tight installations, for example, in ink tanks on printing machines. For applications in harsh environments, the IP67 degree of protection ensures the ultimate in robust construction and availability.

These diffuse mode sensors—available either with switching or analog output—are impressively user-friendly with teach-in configuration.

Highlights

- Minimal space requirement, small dead bands: ideal for tight installations
- IP67 environmental protection: maximum availability in harsh environments
- Simple configuration via teach-in
- Three detection ranges, switching or analog output: the right solution for every requirement

Technical Data	UB120-12GM	UB200-12GM	UB400-12GM
Sensing mode	Diffuse	Diffuse	Diffuse
Sensing range	15 ... 120 mm	15 ... 200 mm	30 ... 400 mm
Operating voltage	10 ... 30 V DC/15 ... 30 V DC (analog voltage output)		
Output type	1 switching output (PNP or NPN)/ 1 analog output (current or voltage)		

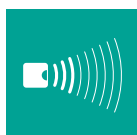

Detection range
max. 400 mm

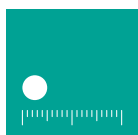

Dimensions
Ø 12 × 70 mm



Degree of
protection

Extremely Flexible in Tough Installation Conditions

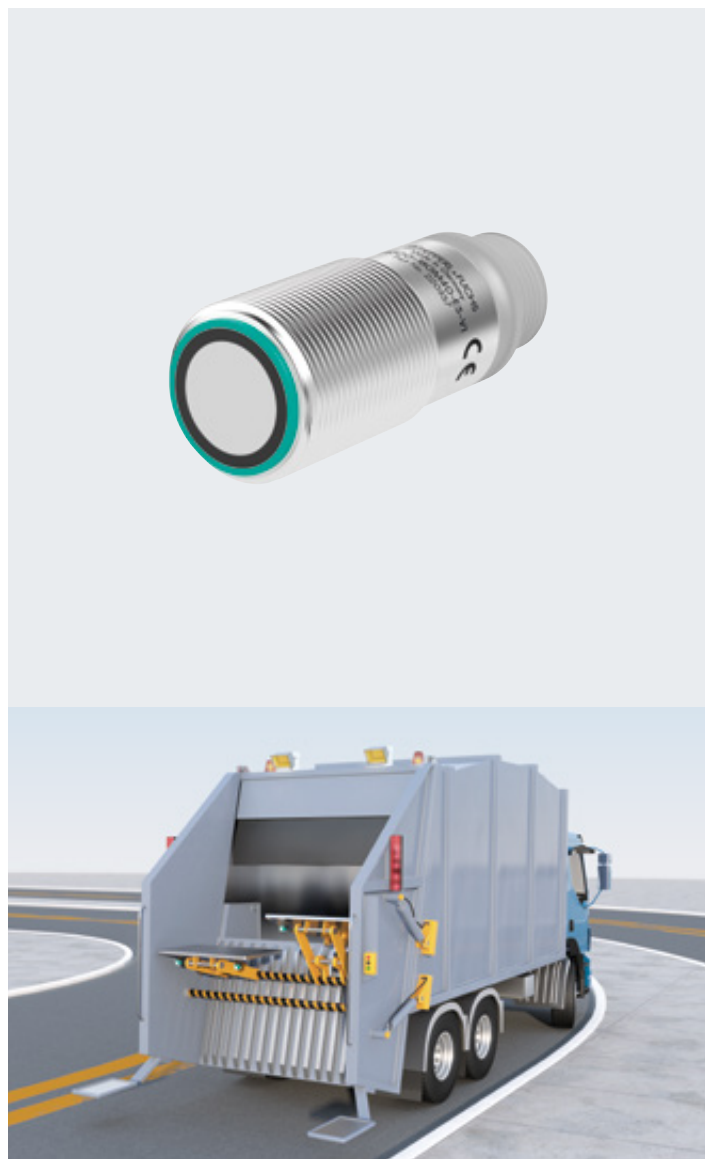

18GM40 and 18GM60 Series

The 18GM40 series of thru-beam and diffuse mode sensors is the ideal solution for tough installation conditions. The extremely short design of the sensors saves space, while the versions with right-angled ultrasonic transducers offer an additional level of flexibility during integration, such as in space-restricted installations.

Owners of road construction vehicles, refuse collection trucks and other vehicles in the mobile equipment sector demand high dependability under the most extreme conditions. Consequently, the reliability requirements on industrial sensors used on mobile equipment vehicles are exceptionally high. This is why the 18GM60 series of ultrasonic sensor with improved electronic design, increased EMC resistance and E1 approvals are so successful in these applications.

Highlights

- Wide variety of integration options through special design and graduated detection areas
- Different output versions offer flexible solutions for measuring or switching applications
- IP67 environmental protection for maximum reliability and availability under tough operating conditions

Technical Data	UB300-18GM40(A)	UB800-18GM40(A)	UBE1000-18GM40(A)	UB300-18GM60(A)	UB800-18GM60(A)
Sensing mode	Diffuse	Diffuse	Thru-beam	Diffuse	Diffuse
Sensing range	35 ... 300 mm	50 ... 800 mm	15 ... 1,000 mm	35 ... 300 mm	50 ... 800 mm
Operating voltage	10 ... 30 V DC/15 ... 30 V DC (analog voltage output)		10 ... 30 V DC	10 ... 30 V DC	10 ... 30 V DC
Output type	1 switching output (PNP or NPN)/ 1 analog output (current or voltage)		1 switching output (PNP NO contact)	1 switching output E5, PNP, normally-open/normally-closed, parameterizable	1 switching output E5, PNP, normally-open/normally-closed, parameterizable

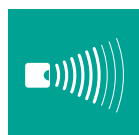

Detection range
max. 1,000 mm

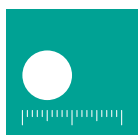

Dimensions
Ø 18 x 40-68 mm



Angled
transducer



Degree of
protection



Certification

Using Technology to Its Fullest Potential



UB18GM and UC18GS Series

The UB18GM series has proven itself in a multitude of applications. The width of the sound beam can be easily adapted to any detection situation. The synchronization option avoids cross-talk between sensors that are installed close together, guaranteeing a reliable measurement function.

With features such as echo suppression, adjustable sound beam width, extended synchronization, a very small dead band, IO-Link and infrared interface, and push buttons, the UC18GS series offers an unprecedented variety of functions and adjustment options in a single device. This gives the user the greatest possible amount of flexibility.

Highlights

- Versatility: broad range of applications solved in one compact sensor
- Reliable processes: interference target suppression for consistent measurement values
- Individual modification: adjustable sound beam for rapid adaption to the application—without losing range
- Fault-free operation: automatic sensor synchronization when using several sensors in tight spaces
- Flexible commissioning: convenient programming and parameterization via pushbuttons, IrDA interface, or IO-Link (DTM/PACTware)

Technical Data	UB500-18GM75	UB1000-18GM75	UC500-18GS	UC1000-18GS
Sensing mode	Diffuse	Diffuse	Diffuse	Diffuse
Sensing range	30 ... 500 mm	70 ... 1,000 mm	30 ... 500 mm	70 ... 1,000 mm
Operating voltage	10 ... 30 V DC/15 ... 30 V DC (analog voltage output)		10 ... 30 V DC	10 ... 30 V DC
Output type	1 switching output (PNP or NPN)/ 2 switching outputs (both PNP or both NPN)/ 1 analog output (current or voltage)		2 push-pull switch outputs/ 1 push-pull switch output and 1 analog output (current or voltage)	

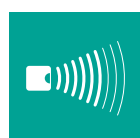

Detection range
max. 1,000 mm

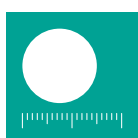

Dimensions
Ø 18 × 75 mm

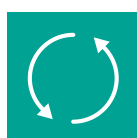

Synchronizable



Degree of protection



Customizable
without software



Numerous parameterization options

Highly Resistant



UB-30GM Series

UB-30GM series diffuse mode sensors are easy to adjust via the teach-in input. They can be synchronized so that maximum detection and switching reliability is guaranteed in mounting situations with several sensors side by side.

The sensors are extremely robust and vibration-resistant, delivering reliable measurements at all times while resisting interference such as compressed air. The diversity of ranges makes this series the ideal solution for monitoring bulk goods in silos of varying sizes, for example.

Highlights

- Varying levels of detection coverage for a variety of applications
- Synchronization and IP65 environmental protection for maximum reliability
- High degree of vibration resistance for use in harsh and mobile applications

Technical Data	UB500-30GM	UB2000-30GM	UB4000-30GM	UB6000-30GM
Sensing mode	Diffuse	Diffuse	Diffuse	Diffuse
Sensing range	30 ... 500 mm	80 ... 2,000 mm	200 ... 4,000 mm	350 ... 6,000 mm
Operating voltage	10 ... 30 V DC			
Output type	1 switching output (PNP or NPN)			

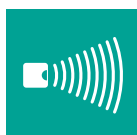

Detection range
max. 6,000 mm



Dimensions
Ø M30

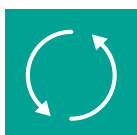

Synchronizable



Degree of protection

Intuitive Programming

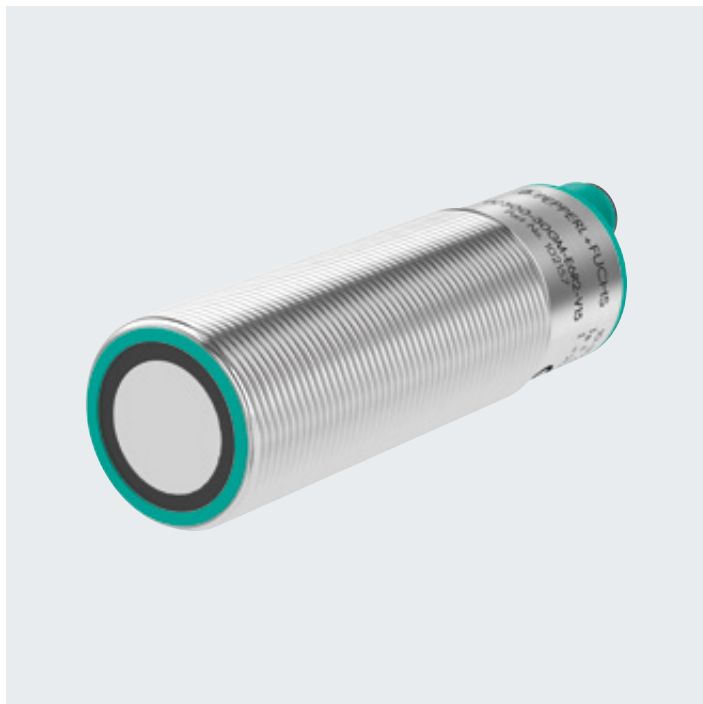

UC-30GM Series

Because of their comprehensive parameterization options and easy configuration via integrated programming plug, these diffuse mode sensors are well suited to applications where customized sensor adjustment is necessary. Versions with offset transducers provide an additional level of flexibility during machine integration.

With these features, they offer an impressive array of potential uses, such as measuring the distance between the crane and the container in container spreaders.

Highlights

- Comprehensive parameterization for customized sensor adjustment
- Intuitive programming and configuration for easy commissioning
- Versions with remote transducers increase installation flexibility

Technical Data	UC500-30GM	UC2000-30GM	UC4000-30GM	UC6000-30GM
Sensing mode	Diffuse	Diffuse	Diffuse	Diffuse
Sensing range	30 ... 500 mm	80 ... 2,000 mm	200 ... 4,000 mm	350 ... 6,000 mm
Operating voltage	10 ... 30 V DC			
Output type	2 switching outputs (both PNP or both NPN)/ 2 analog outputs (current and voltage)			



Detection range
max. 6,000 mm



Dimensions
Ø M30

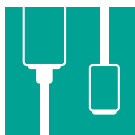

Separate
transducer

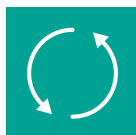

Synchronizable



Degree of
protection



Numerous parame-
terization options

Convenient Commissioning and Parameterization

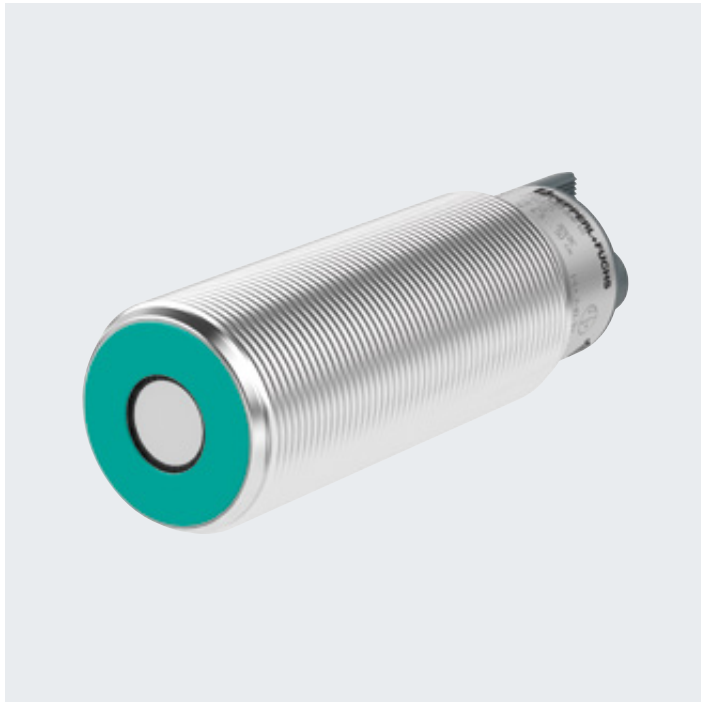

30GM70 Series

The 30GM70 series is easy to customize to any application, such as in difficult installation conditions with interfering objects, and where parameterization is required without interrupting the process. Versions with rotating or remote transducers provide ideal installation flexibility. Where commissioning brings particular challenges, pulse echoes can be visualized in real time to align the sensor precisely and suppress noise.

Diffuse mode sensors are versatile—they can be used to measure fill levels in tanks and silos or to detect gaps between fruit trees to optimize the use of insecticides and herbicides.

Highlights

- Adjustable detection ranges for different object distances
- Infrared interface allows direct sensor access for PC-based parameterization or diagnosis
- Reactionless parameterization during operation avoids process interruptions
- Various transducer orientations to handle any mounting conditions

Technical Data	UC500-30GM70(S)	UC2000-30GM70(S)	UC3500-30GM70(S)	UC6000-30GM70(S)
Sensing mode	Diffuse	Diffuse	Diffuse	Diffuse
Sensing range	45 ... 500 mm	100 ... 2,000 mm	200 ... 3,500 mm	350 ... 6,000 mm
Operating voltage	12 ... 30 V DC/20 ... 30 V DC (analog output)			
Output type	2 switching outputs (both PNP)/ 1 switching output (PNP) + 1 analog output (current or voltage)			



Detection range
max. 6,000 mm



Dimensions
Ø M30



Swiveling
transducer

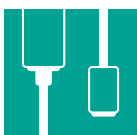

Separate
transducer

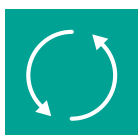

Synchronizable



Degree of
protection



Numerous parame-
terization options

Incredibly Simple Integration via IO-Link

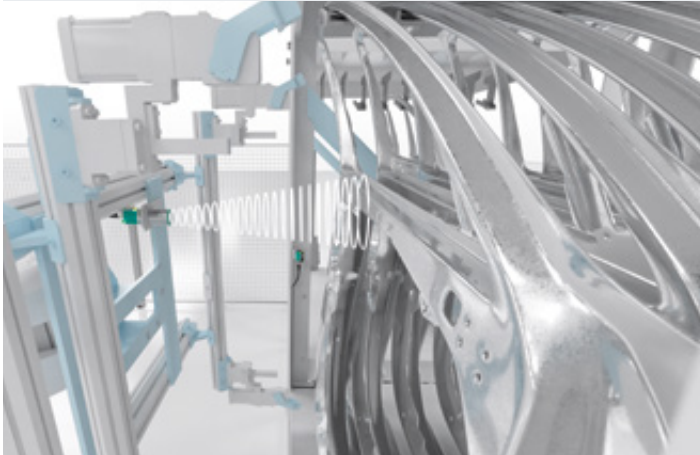
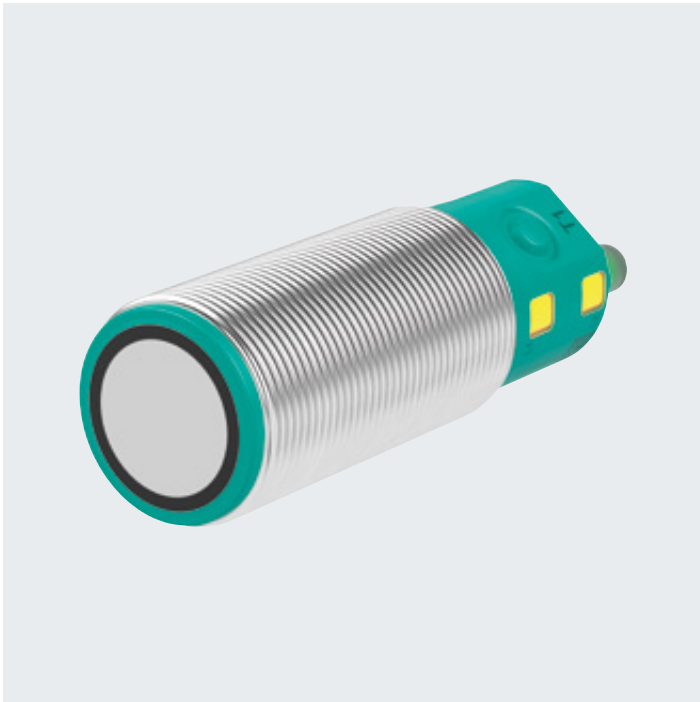

30GM-IO Series

30GM-IO series diffuse mode sensors are the multifunctional solutions for a host of applications, from fill level measurement and presence detection to object counting and distance measurement. They are incredibly simple to parameterize, either using the buttons on the sensor or via the IO-Link interface.

Via this communication channel, the sensors can be integrated easily into the control panel to exchange both process and service data. Different sound beam widths can be set via teach-in to suit the respective detection task. IP67 degree of protection ensures maximum availability.

Highlights

- Simple integration into the control panel via IO-Link
- Integrated diagnostics and flexible parameterization
- Maximum process reliability through direct access to process data and diagnostic data
- Wide array of possible detection ranges

Technical Data	UC500-30GM*IO	UC2000-30GM*IO	UC4000-30GM*IO	UC6000-30GM*IO
Sensing mode	Diffuse	Diffuse	Diffuse	Diffuse
Sensing range	30 ... 500 mm	90 ... 2,000 mm	200 ... 4,000 mm	350 ... 6,000 mm
Operating voltage	10 ... 30 V DC			
Output type	2 switching outputs (both push-pull)/ 1 switching output (PNP) + 1 analog output (current or voltage)			

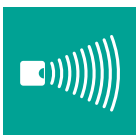

Detection range
max. 6,000 mm



Dimensions
Ø M30



Synchronizable



Degree of
protection



IO-Link



Numerous parame-
terization options

Maximum Chemical Resistance

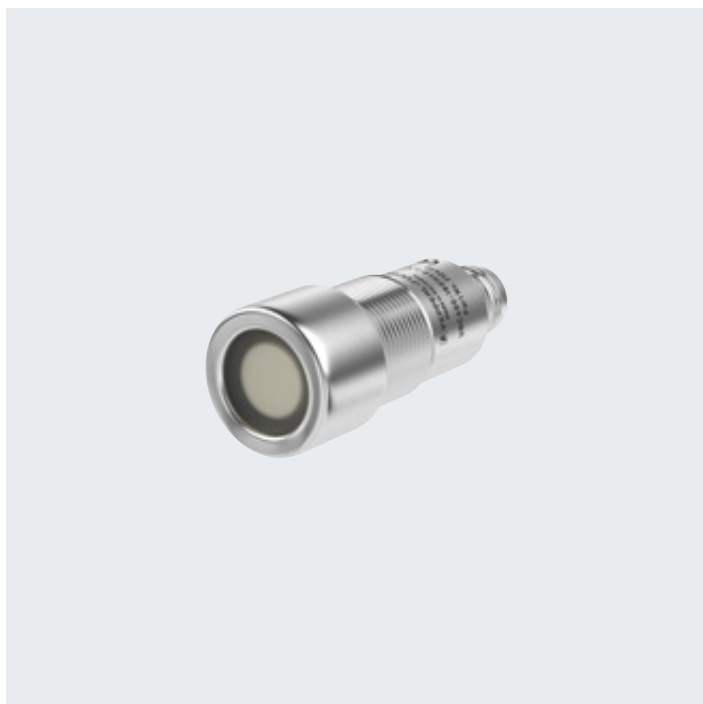

UBC Series

UBC series ultrasonic sensors offer maximum material resistance for ultimate availability even in the toughest operational conditions. The thru-beam and diffuse mode sensors come with the highest degree of protection and are hermetically sealed against aggressive atmospheres, for example, when measuring the fill level of acids. Configuration via the teach-in input is quick and easy.

Highlights

- High level of chemical resistance for maximum durability
- Housing made of high-quality stainless steel (V4A)
- PTFE-coated ultrasonic transducer
- IP68/69K environmental protection
- Easy to configure via teach-in input

Technical Data	UBC250-12GM	UBC400-18GH40	UBEC300-18GH40
Sensing mode	Diffuse	Diffuse	Thru-beam
Sensing range	30 ... 250 mm	40 ... 400 mm	100 ... 300 mm
Operating voltage	10 ... 30 V DC		
Output type	1 switching output (PNP)/ 1 analog output (current)/ additional versions on request	1 analog output (current)/ additional versions on request	1 switching output (PNP NO contact)

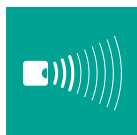

Detection range
max. 400 mm

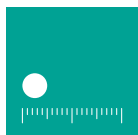

Dimensions
Ø M12/M18



Degree of
protection

Highly Resistant with Versatile Parameterization Options

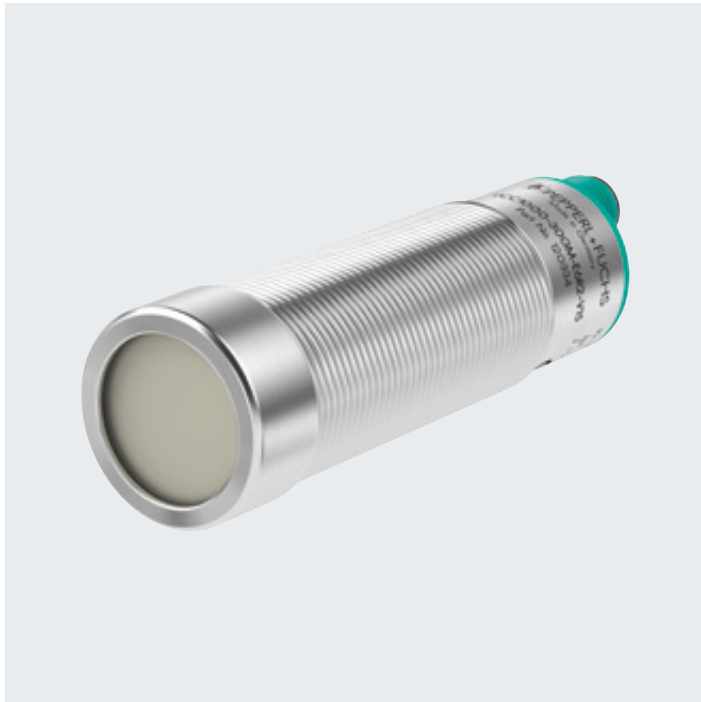

UCC Series

Complementing the UBC series, these sensors offer impressive adaptability to a wide range of applications. All of the surfaces that are exposed to aggressive chemicals and atmospheres exhibit a high degree of chemical resistance.

Comprehensive, easy-to-use parameterization functions allow the sensors to be adapted to any application—and synchronized if necessary. The diffuse mode sensors are available with detection ranges of up to six meters. Different output options provide additional flexibility in terms of electrical integration.

Highlights

- Ranges of up to six meters open up a wide field of applications
- Simple parameterization allows optimal adaptation to detection and measuring applications
- High chemical resistance for maximum availability and durability with high-quality stainless steel housing (V2A or V4A) and coated ultrasonic transducer

Technical Data	UCC1000-30GM-...	UCC500-30GH70-...	UCC2000-30GH70-...	UCC3500-30GH70-...	UCC6000-30GH70-...
Sensing mode	Diffuse	Diffuse	Diffuse	Diffuse	Diffuse
Sensing range	80 ... 1,000 mm	45 ... 500 mm	100 ... 2,000 mm	200 ... 3,500 mm	350 ... 6,000 mm
Operating voltage	10 ... 30 V DC	12 ... 30 V DC/20 ... 30 V DC (analog output)			
Output type	2 switching outputs (both PNP)/ 2 analog outputs (current and voltage)	2 switching outputs (both PNP)/ 1 switching output (PNP) + 1 analog output (current and voltage)			



Detection range max. 6,000 mm

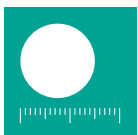

Dimensions Ø M30

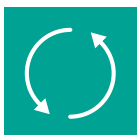

Synchronizable



Degree of protection



Numerous parameterization options

Impressive Robustness in a Compact Housing Design



UMB800 Series

The UMB800 meets the highest standards of chemical resistance and easy cleaning. The sensor is made exclusively of highly resistant materials, such as high-grade stainless steel. The sensor head and all housing parts are laser-welded and therefore hermetically sealed against the ingress of vapor and liquids.

With this design, the UMB800 series satisfies the highest standards of product and process safety for measuring and controlling in coating processes. The highly resistant materials make it ideal for the chemical industry and process engineering.

Highlights

- Ultracompact, all-stainless-steel ultrasonic sensor AISI 316L (1.4404)
- Resistant against aggressive chemicals and cleaning agents
- Withstands high-pressure wash-down and steam jets due to IP68/IP69K degree of protection as well as permanently high temperatures up to +85°C

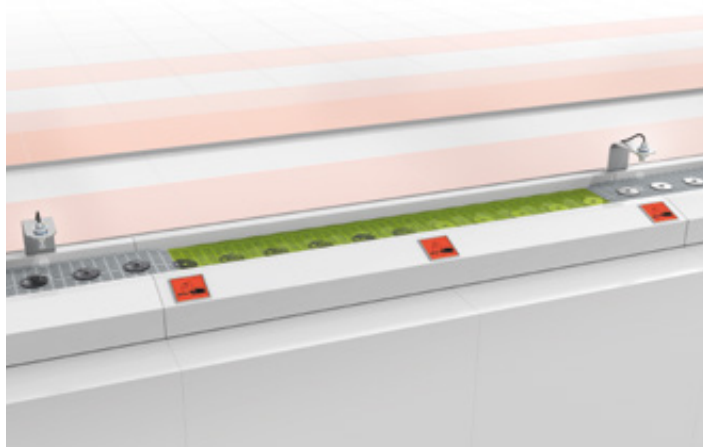

Technical Data

UMB800-18H

Sensing mode	Diffuse
Sensing range	70 ... 800 mm
Operating voltage	10 ... 30 V DC/15 ... 30 V DC (analog voltage output)
Output type	1 switching output (PNP or NPN)/ 1 analog output (current or voltage)

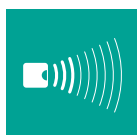

Detection range
max. 800 mm

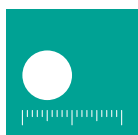

Dimensions
Ø 18 × 56 mm



Degree of
protection

Incredibly Robust with Adjustable Configuration



UMC3000 Series

Like the compact UMB800 series, the UMC3000 series impresses with its fully stainless-steel design and hermetically sealed construction. In addition, this series offers measuring ranges of up to three meters and extensive parameterization options. The sensor is particularly simple and flexible to commission via the teach-in input or serial interface.

These properties ensure perfect adaptation to a wide variety of detection and measurement tasks, such as in fill level monitoring for chemical products.

Highlights

- Product and process safety through highly resistant materials
- Flexible parameterization via teach-in input or serial interface for easy commissioning
- Chemically resistant to aggressive substances and cleaning agents
- IP68/69K environmental protection

Technical Data

UMC3000-30H

Sensing mode	Diffuse
Sensing range	200 ... 3,000 mm
Operating voltage	10 ... 30 V DC
Output type	1 switching output (PNP)/ 1 analog output (current)

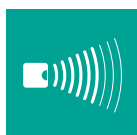

Detection range
max. 3,000 mm



Dimensions
Ø 30 × 100 mm



Degree of
protection



Numerous parame-
terization options



Safety Sensors: Optimal Safety in the Most Adverse Ambient Conditions

State-of-the-art ultrasonic technology offers many advantages, including reliable protection for machines and vehicles—even in safety applications in demanding indoor and outdoor environments.

Maximum Protection with a Compact Design

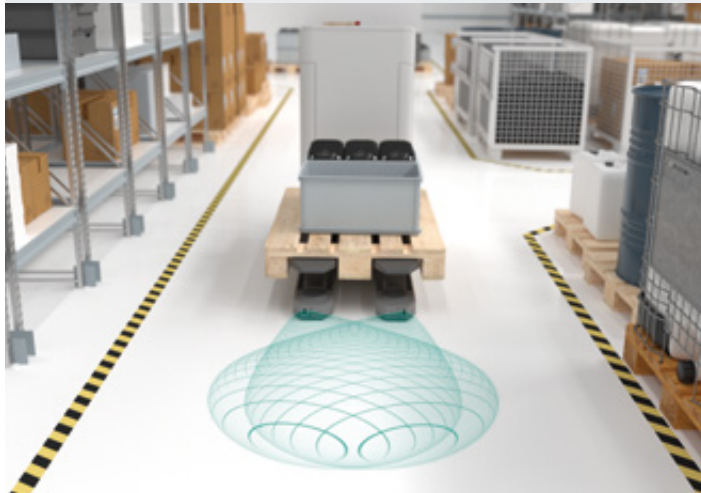

USi-safety Ultrasonic Sensor System

Modern equipment must meet every increasing safety requirement. And state-of-the-art safety solutions not only protect operators, but also increase total system uptime and availability. With its high level of resistance to dirt and fluctuations in temperature and humidity, and its insensitivity to environmental air currents, our USi-safety ultrasonic sensor system is the ideal solution when operators must be safeguarded from harmful machine parts and operations. The exceptionally compact design of the sensing units enables installation in situations that were previously considered too hard to address—for instance, fork arms on automated guided vehicles.

Implementing the USi-safety is remarkably efficient as only one compact ultrasonic sensing unit, connected to the evaluation unit, enables safe applications in accordance with CAT3, PL d. Application flexibility is further increased as multiple dangerous operations can be safeguarded simultaneously by connecting a second sensing unit to one evaluation unit. Optimal safety coverage is assured by the unique “wide and shallow” elliptical 3-D detection field of the USi sensing units.

Highlights

- Unique ultrasonic technology meets safety standards in accordance with category 3 PL d even in harsh environments
- Detached sensor system provides installation flexibility—due to sensing unit in miniature housing even in tight spaces
- Optimal safety protection is assured by the unique “wide and shallow” elliptical 3-D detection field
- Easy teach-in of reference target for high temper protection
- Comprehensive parameterization software automatically generates safety protocols, making commissioning and documentation even simpler

Technical Data	USI-F262* Control Interface	USI2500* Ultrasonic Sensor Unit
Sensing mode	Diffuse	
Sensing range	2,500 mm	
Operating voltage	21... 28 V DC	
Output type	2 OSSD outputs per channel/ 1 transistor output (PNP) per channel	



Detection range max. 2,500 mm

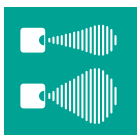

Elliptical detection area of ±17° and ±5°



Dimensions 27 × 13 × 21 mm



Category 3 PL d-certified



Degree of protection (applies to the front face of the USI2500 ultrasonic sensor unit)



Ultrasonic Modules: Incredible Flexibility and Efficiency

The versatile ultrasonic modules meet every challenge, be it harsh ambient conditions, humidity, or dirt. The switchable sound beam width, integrated temperature sensor, and special PTFE converter coating in a compact housing design make the modules ideal for reliable fill level detection in water and wastewater tanks, silos, and disposal containers.

Versatile and Space-Saving

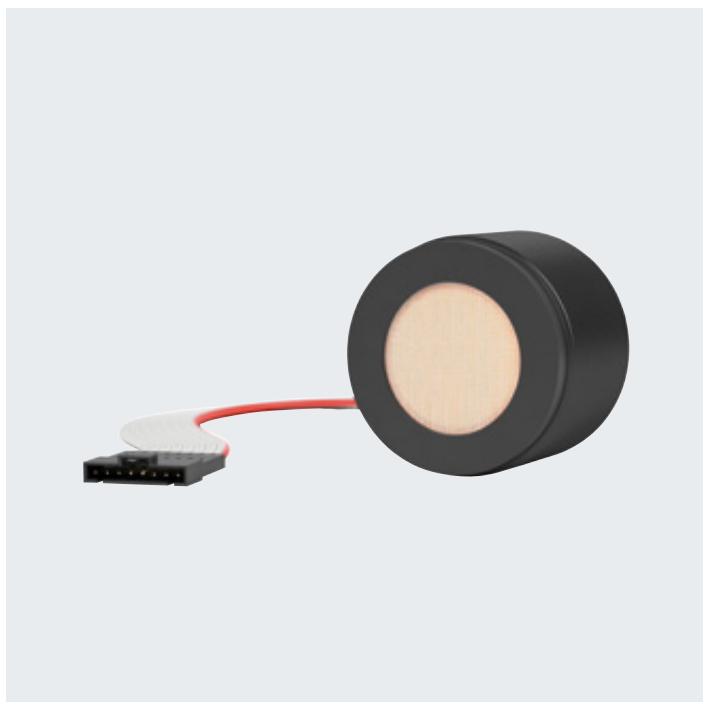

UCC50GK Series

The UCC*-50GK ultrasonic sensor offers the user incredible flexibility and efficiency. By being easy to configure, it covers a range of application requirements, and can be integrated into a wide variety of applications without control via UART, LIN bus, or PWM.

Equipped with a power save mode and optimized for battery operation, the UCC*-50GK ultrasonic sensor is perfect for wireless communication, where longer run times are essential. An adjustable sound beam and three preinstalled sound profiles make the sensor ideal for measuring distances up to four meters, even in confined spaces.

Highlights

- Cost-efficient, high-performance ultrasonic sensor
- Easy controller integration via UART, LIN bus, and PWM
- Low-power mode for solar and battery-supplied systems
- Adjustable beam width for precise sensing in tight spaces
- Temperature compensation for accurate measurements



Technical Data	UCC2500-50GK	UCC4000-50GK
Sensing mode	Diffuse	Diffuse
Sensing range	150 ... 2,500 mm	250 ... 4,000 mm
Operating voltage	$U_{\text{UART/PWM}} = 2.5 \dots 5 \text{ V DC, typically } 3.3 \text{ V}$ $U_{\text{LIN}} = 8 \dots 18 \text{ V DC, typically } 12 \text{ V}$	
Output type	PWM output (PNP), not short-circuit-proof	
Interface	UART, LIN	

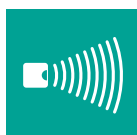

Detection range
max. 4,000 mm

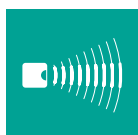

Adjustable
sound beam

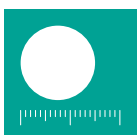

Dimensions
50 × 50 × 37 mm



Power save
mode, standby

Wireless Sensors: Smart Monitoring of Fill Levels



Smart industry, smart logistics, smart farming, smart environment, and smart city—special applications require special sensor technology. Autonomous IoT wireless sensors from Pepperl+Fuchs combine all the important features for challenging industrial application scenarios with the advantages of wireless radio transmission.

Innovative Sensor Solution Ensures Flexibility



WILSEN.sonic.level Series

The battery-operated wireless fill level sensor WILSEN.sonic.level is used in various IoT applications. Adjustable sensor parameters such as the width of the sound beam and the easy-to-use mobile device app allow the sensor to be set up individually for the application directly at the operating location via Bluetooth® LE. The standardized energy-efficient LoRaWAN® technology allows the sensor to autonomously transmit the relevant data over a range of many kilometers for several years.

In addition to the fill level, the WILSEN.sonic.level records the geolocation and transmits this data safely over the Internet. Temperature values and battery charge status are also provided.

Highlights

- Industrial-quality wireless IoT sensor for level measurement applications
- Geolocation of containers, tanks, and silos
- Globally standardized LoRaWAN® network for efficient, long-range signal transmission
- Easy to install and operate: mobile app simplifies device and system configuration
- Rugged solution, ready for use in harsh environments

Technical Data	WS-UCC2500	WS-UCC4000
Sensing mode	Diffuse	Diffuse
Sensing range	150 ... 2,500 mm	250 ... 4,000 mm
Power supply	Replaceable high-power lithium battery 3.6 V, 13,000 mAh	
Interface	LoRaWAN	

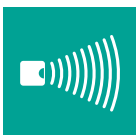

Detection range
max. 4,000 mm



LoRaWAN



Degree of
protection



Geolocation



Battery-
powered

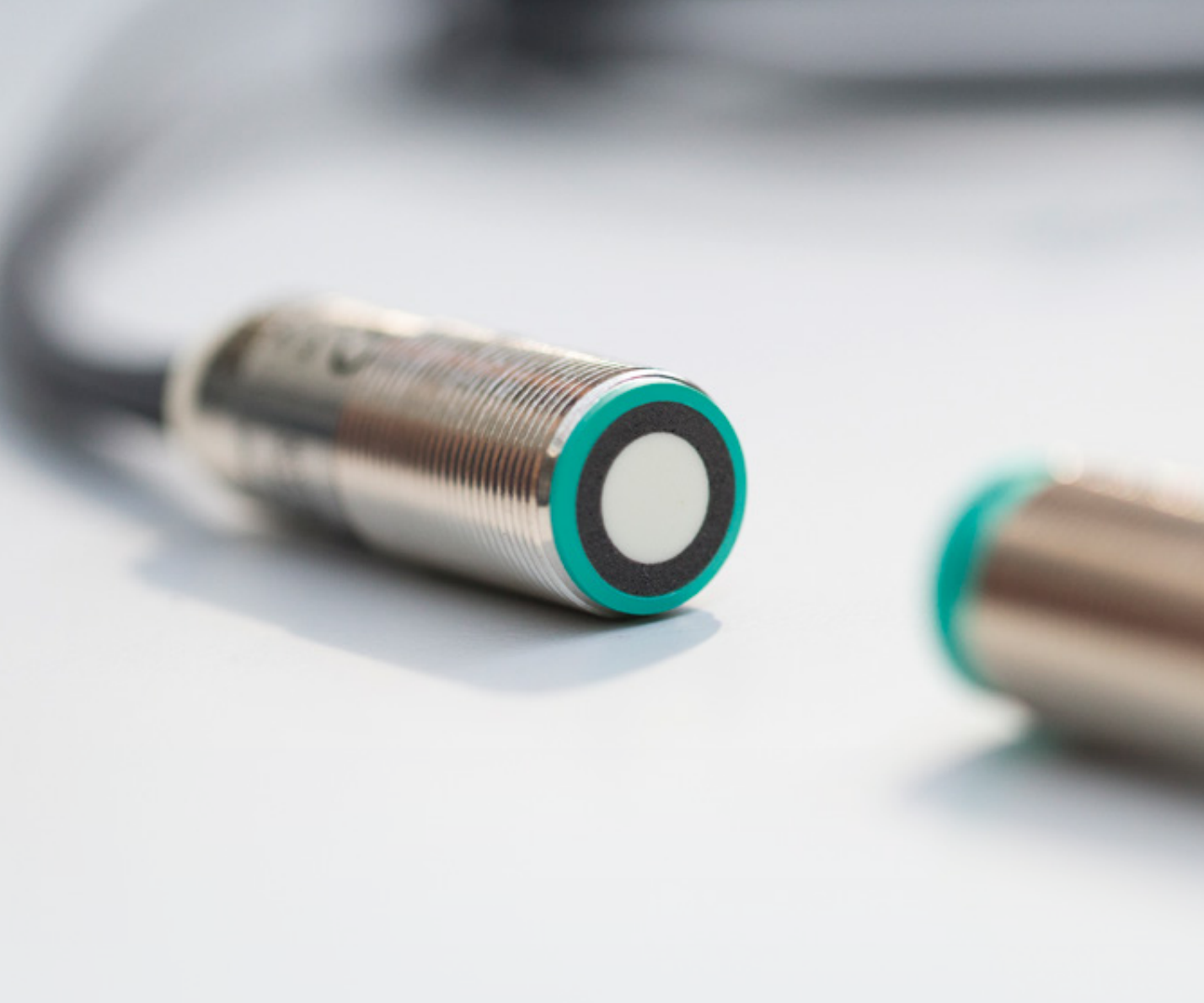

Double Material Detection: Monitoring Continuous Processes

An accidental, multilayer feed of materials such as paper, card, metal, film, or labels can cause machine downtime, process faults, and waste. Ultrasonic sensors for double material detection help prevent faulty material feed and ensure reliable processes and maximum uptime.

Years of Experience in Sophisticated Sensor Solutions

Double material detection places unique demands on an ultrasonic sensor and requires special expertise. Pepperl+Fuchs has more than 15 years of in-depth development and manufacturing competence in this field and has provided solutions for countless applications. Pepperl+Fuchs now offers tried-and-tested technology that delivers reliable solutions, even in extremely demanding applications.

Ultrasonic double material detection prevents unwanted infeed of multiple materials, ensuring continuous, error-free processes. Two separate ultrasonic transducers are used in this solution, which measure the attenuation of sound by the material between the emitter and receiver. They compare the measured value with the programmed set point and emit a switching signal in the event of an incorrect material feed. This technology can be used in the detection of double sheets, labels, and splices.

Double Sheet Detection

Double sheet detection guarantees maximum process reliability when only one layer of material is permitted to be fed into a machine. Whether on printing machines, in sheet metal processing, or when veneering chipboard, the double sheet sensors from Pepperl+Fuchs reliably prevent the infeed of double sheets or incorrect sheets.

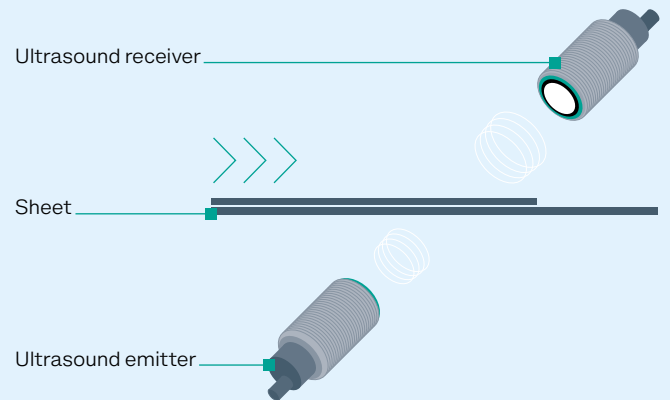

Ultrasonic Splice Detection

When processing material in rolls, the material from a new roll is often spliced to the web of the dwindling roll, avoiding the time-consuming process of feeding a new roll to the machine. Ultrasonic sensors for splice control detect the splice tape, which is undesirable in the final product. The tape is cut out of the web before the subsequent processing stage. In this way, splice detection sensors help ensure continuous material flow and a perfect end product.

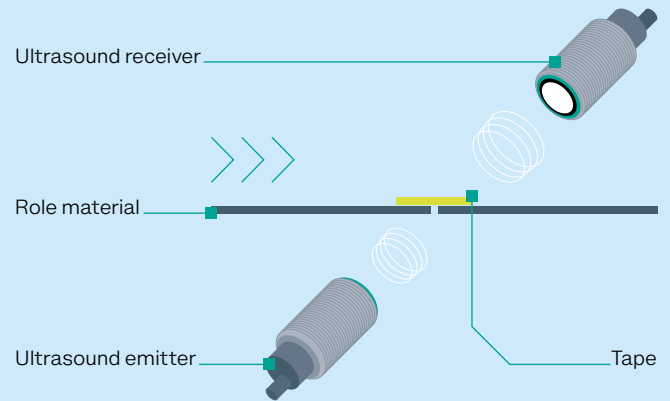

Ultrasonic Label Detection

Ultrasonic sensors for label detection allow labels to be counted during manufacturing and recorded and positioned in the labeling system. Once the sensors have been taught on the material, they are able to detect labels reliably and at high speed.

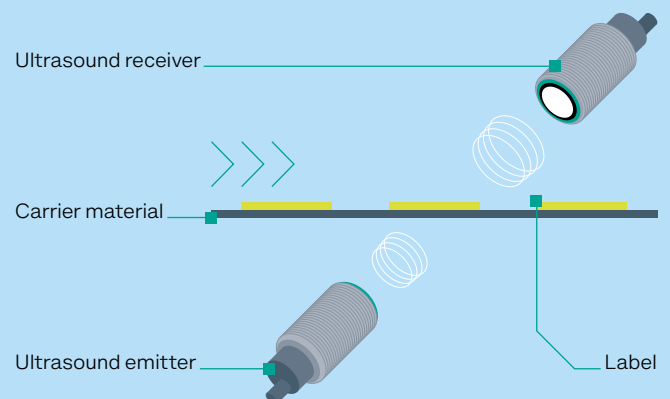

Precise Layer Detection for Correct Material Feed

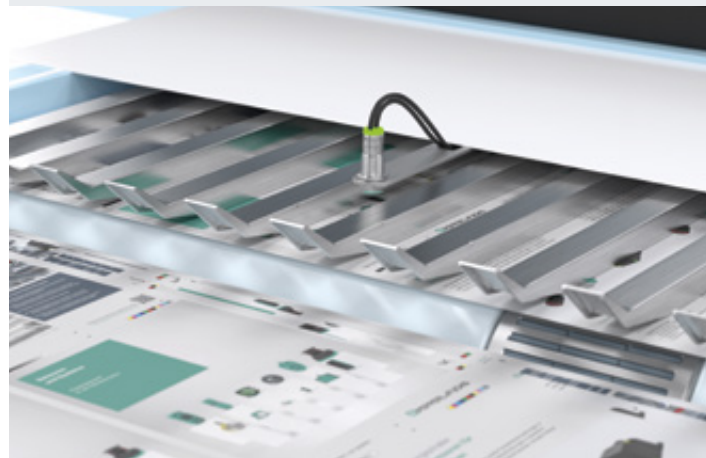

UDC-18GS-*IO-* Series Double Sheet Sensors

The UDC-18GS-*IO-* series double sheet sensors are ideal for monitoring the material feed on printing and paper machines. Whether it is thin paper or thick cardboard, the sensors can handle a wide variety of materials and thicknesses using just one setting thanks to their preconfigured set of threshold values.

If necessary, it is possible to change to another threshold set or to adapt the devices to the application via the teach-in function. The IO-Link interface ensures a high level of machine availability and enables access to all sensor parameters, diagnostic data, and process data. The automatic synchronization function provides maximum process safety when using several sensors in a confined space.

Highlights

- Flexibility: detection of a wide range of materials and material thicknesses using just one configuration
- High machine availability: integrated IO-Link interface enables access to sensor parameters, diagnostic and process data
- Fast commissioning via predefined threshold set, IO-Link, or simple teach-in with feedback
- Maximum process reliability: automatic sensor synchronization when using multiple sensors in a confined space

Technical Data	UDB-18GS-*	UDC-18GS-*IO-*
Sensing mode	Double sheet control	Double sheet control
Distance transmitter/receiver	20 ... 60 mm	20 ... 60 mm
Operating voltage	18 ... 30 V DC	18 ... 30 V DC
Response delay	15 ms (shorter response times on request)	15 ms (minimum setting of 1,5 ms)
Output type	2 switching outputs (all of them PNP or all of them NPN, all of them normally-closed or all of them normally-open)	3 push-pull outputs (can be programmed to all of them normally-closed or all of them normally-open)

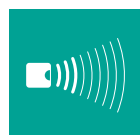

Detection range
max. 60 mm

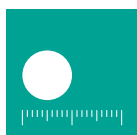

Dimensions
Ø M18



Degree of
protection



IO-Link 1.1
(spec. 1.1.3)

Reliable Monitoring of Thick Materials

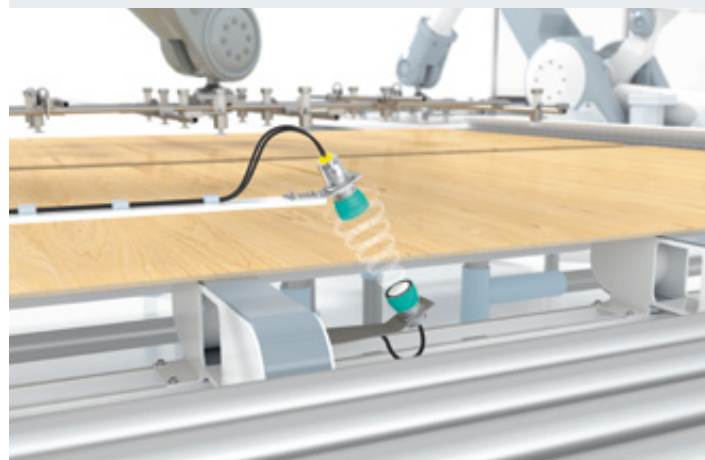

UDC(M)-30GS-*IO-* Series Double Sheet Sensors

UDC(M)-30GS-*IO-* series double sheet sensors ensure process safety when feeding in especially thick materials. For example, double metal sheet detection allows individual sheets that are up to 3.5 mm in thickness to be prepared in the appropriate way for metal-forming presses.

When processing solid and multilayer parquet in a sawmill or wooden panels and chipboard in furniture manufacturing, these sensors reliably detect missing or double sheets and therefore prevent machine downtime, damage to tools, and material waste.

Highlights

- Ideal for thick materials: reliable detection of metal sheets, duplex corrugated paper, parquet, wooden boards, or oriented strand boards
- Multipurpose use: versions available for detecting metal sheets that are up to 3.5 mm in thickness
- High machine availability: integrated IO-Link interface enables access to sensor parameters, diagnostic and process data
- Fast commissioning via predefined threshold set, IO-Link, or simple teach-in with feedback
- Maximum process reliability: automatic sensor synchronization when using multiple sensors in a confined space

Technical Data	UDC(M)-30GS-*IO-*
Sensing mode	Double sheet control
Distance transmitter/receiver	50 ... 150 mm
Operating voltage	18 ... 30 V DC
Response delay	30 ms
Output type	3 push-pull outputs (can be programmed to all of them normally-closed or all of them normally-open)

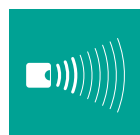

Detection range
max. 150 mm



Dimensions
Ø M30



Degree of
protection



IO-Link 1.1
(spec. 1.1.3)

Monitoring Web Materials



ULB/UGB-18GM50 Series Label and Splice Detection Sensors

The sensor solutions in the ULB-18GM50 and UGB-18GM50 series have been specially developed to reliably detect materials that are glued together.

The label sensors can precisely determine the transition points between the carrier material and the label and detect, position, or count these reliably.

The material should be fed without interruption to packaging and roller-printing machines. Therefore, in the case of a roll change, the initial material of the new roll is spliced onto the outgoing roll, and thus fed into the machine without interruption. In the subsequent process, the UGB-18GM50 splice detection sensors detect this splice point and enable the targeted removal of the overlay.



Highlights

- Compact design, ideal for compact installations
- Maximum detection reliability even at high process speeds
- Easy operation through teach-in of the web material
- Ideal for transparent materials
- Specially adapted splice detection sensors are available for materials with varying density

Technical Data	ULB-18GM50	UGB-18GM50
Sensing mode	Label detection sensor	Splice detection sensor
Distance transmitter/receiver	20 ... 60 mm	
Operating voltage	18 ... 30 V DC	
Response delay	600 µs	
Output type	2 switching outputs (all of them PNP NC contacts) 2 switching outputs (all of them NPN NC contacts)	

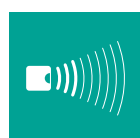

Detection range
max. 60 mm

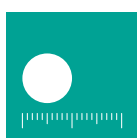

Dimensions
Ø M18



Degree of protection
IP67



Accessories

The Perfect Addition: Accessories and Other Components

Alignment and Mounting Aids

Quick and secure alignment and attachment—mounting aids, adjustment aids, and deflectors simplify any installation and commissioning process.

Programming Devices and Adapters

Define switch points, select output functions, optimize parameters—the programming devices and adapters mean essential sensor parameters can be set individually. The sensor configuration can therefore be optimized for the application.

IO-Link Master

As the link between a PC and an IO-Link sensor, the IO-Link USB master allows for convenient, software-supported configuration, parameterization, and diagnostics of the connected device.

Software

PACTware is a user-friendly manufacturer- and fieldbus-independent software that allows ultrasonic sensors to be parameterized for specific applications.

Connectivity

In Pepperl+Fuchs' Connectivity portfolio, sensors and connection technology are perfectly coordinated down to the last detail for seamless integration into your application.

ООО “РусАвтоматизация”

454010 г. Челябинск, ул. Гагарина 5, оф. 507
тел. 8-800-775-09-57 (звонок бесплатный), +7(351)799-54-26, тел./факс +7(351)211-64-57
info@rusautomation.ru; [русавтоматизация.рф](http://rusавтоматизация.рф); www.rusautomation.ru